



Chipsmall Limited consists of a professional team with an average of over 10 year of expertise in the distribution of electronic components. Based in Hongkong, we have already established firm and mutual-benefit business relationships with customers from,Europe,America and south Asia,supplying obsolete and hard-to-find components to meet their specific needs.

With the principle of “Quality Parts,Customers Priority,Honest Operation,and Considerate Service”,our business mainly focus on the distribution of electronic components. Line cards we deal with include Microchip,ALPS,ROHM,Xilinx,Pulse,ON,Everlight and Freescale. Main products comprise IC,Modules,Potentiometer,IC Socket,Relay,Connector.Our parts cover such applications as commercial,industrial, and automotives areas.

We are looking forward to setting up business relationship with you and hope to provide you with the best service and solution. Let us make a better world for our industry!



## Contact us

Tel: +86-755-8981 8866 Fax: +86-755-8427 6832

Email & Skype: info@chipsmall.com Web: www.chipsmall.com

Address: A1208, Overseas Decoration Building, #122 Zhenhua RD., Futian, Shenzhen, China



## Your Search for Proximity Sensors Starts with the World-leading Performance and Quality of the E2E

- Standard Sensors for detecting ferrous metals.
- Wide array of variations. Ideal for a variety of applications.
- Models with different frequencies are also available to prevent mutual interference.
- Superior environment resistance with standard cable made of oil-resistant PVC and sensing surface made of material that resists cutting oil.
- Useful to help prevent disconnection. Cable protector provided as a standard feature.



(Standards do not apply to all models.)



For the most recent information on models that have been certified for safety standards, refer to your OMRON website.



Be sure to read *Safety Precautions* on page 25.

## Features

### 2-Wire Models

### Pre-wired Models with Oil-resistant Reinforced PUR Cables Added to the Lineup and Easy Differentiation with Orange Head

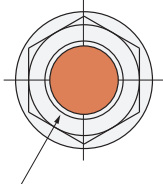

Differentiation from standard models: Orange Head



**Oil Resistance** (Insulation service life): twice or three times that of oil-resistant vinyl chloride

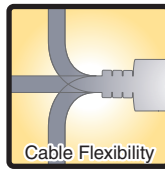

**Cable Flexibility:** approximately twice that of vinyl chloride cables

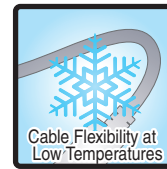

**Cable Flexibility at Low Temperatures**  
More Flexibility at -40°C

### Lineup includes models with Smartclick pre-wired connectors for fast connection.

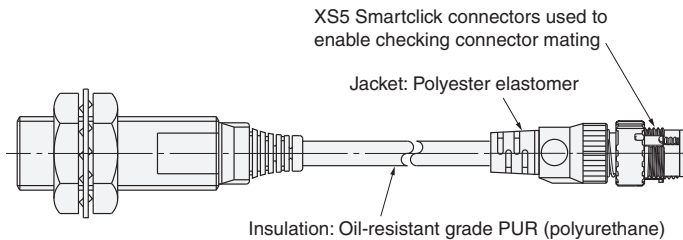
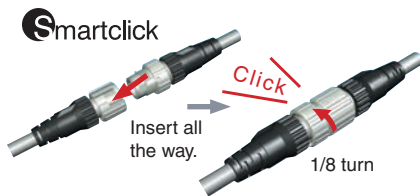

### UL-recognized Models Available



---

**Lineup includes models with self-diagnostic output to provide notification of failures and unstable detection conditions, such as coil burnout.**

- Contributes to preventive maintenance to keep the line from stopping.

**Reduced wiring, fewer resources, and low power consumption contribute to environmentalism.**

- Wiring work and amount of copper wire used reduced to two thirds of that required for 3-wire models.
- Current consumption drastically reduced to less than 10% (when a DC 2-wire model is compared with a DC 3-wire model).

### 3-Wire Models

**Wide range of ambient operating temperatures:  $-40^{\circ}\text{C}$  to  $85^{\circ}\text{C}$  (M8 to M30 models)**

- Suitable for low-temperature and high-temperature applications, which are troublesome for photoelectric sensors.

**Lineup includes models with flexible cable (M8 to M30 models)**

- Reduced risk of disconnection in applications with moving parts.

## E2E Guide to Selection by Purpose

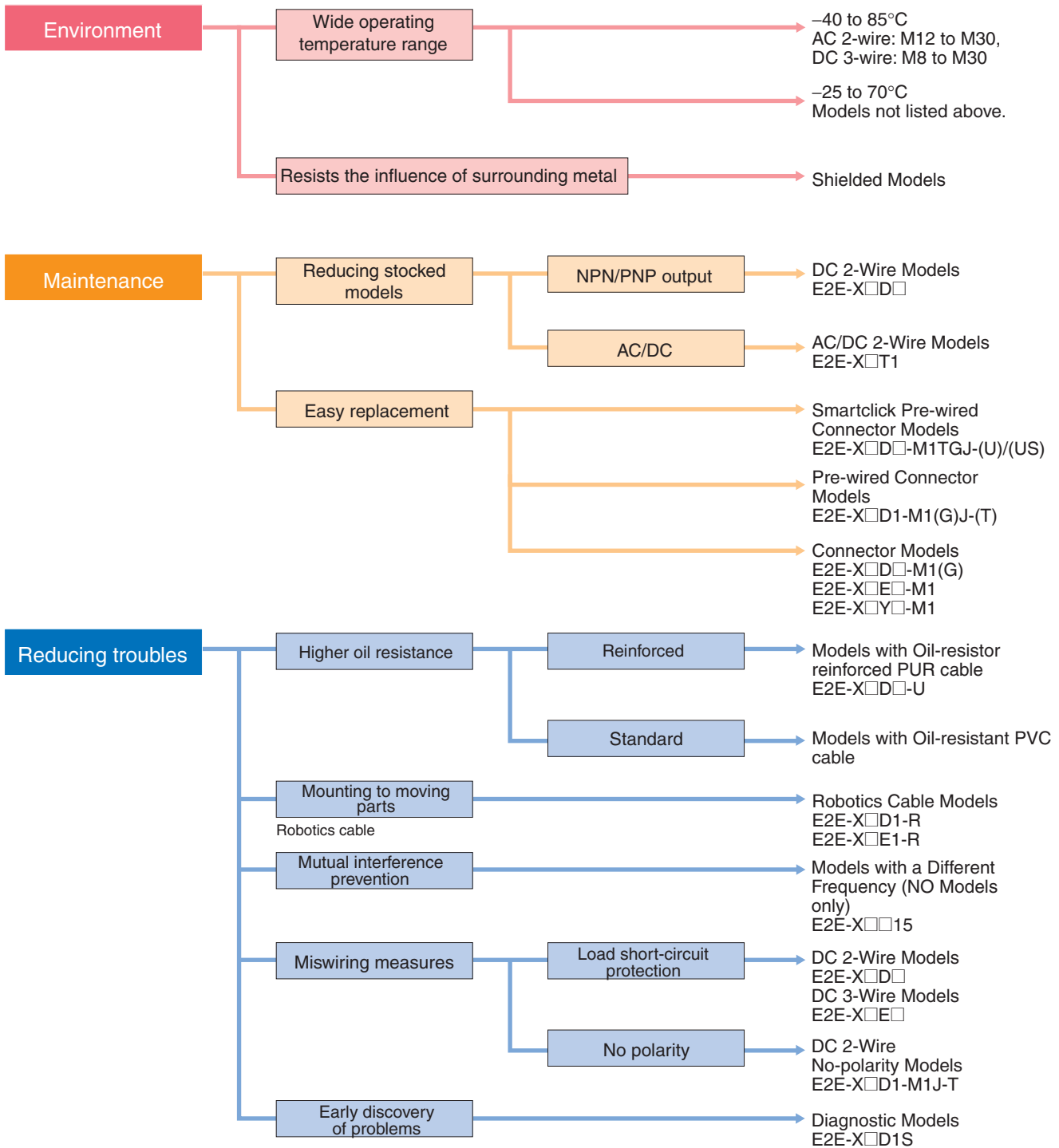

Note: Refer to *Models Not Listed in this Catalog* for Long Body Models, Transmission Couplers, and Power Couplers.

## E2E Model Number Legend

E2E- ① ② ③ ④ ⑤ ⑥ ⑦ - ⑧ ⑨ - ⑩ - ⑪ - ⑫ ⑬

No.	Classification	Code	Meaning	Remarks
①	Appearance	X	Cylindrical (threaded)	
②	Sensing distance	Number	Sensing distance (Unit: mm)	Example: 1R5: 1.5 mm
		R	Indication of decimal point	
③	Shielding	Blank	Shielded Model	
		M	Unshielded Model	
④	Power supply and output specifications	B	DC 3-wire PNP open-collector output	Whether D models have polarity is defined by number ⑩.
		C	DC 3-wire NPN open-collector output	
		D	DC 2-wire polarity/no polarity	
		E	DC 3-wire NPN collector load built-in output	
		F	DC 3-wire PNP collector load built-in output	
		T	AC/DC 2-wire	
		Y	AC 2-wire	
⑤	Form of output switching element	1	Normally open (NO)	
		2	Normally closed (NC)	
⑥	Oscillation frequency type	Blank	Standard frequency	Used to prevent mutual interference.
		5	Different frequency	
⑦	Self-diagnosis	Blank	No	
		5	Yes	
⑧	Connection method	Blank	Pre-wired	
		M1	M12-size metal connector	
		M3	M8-size metal connector	
⑨	Connector specifications	Blank	Connector Model DC 3-wire and AC 2-wire, DC 2-wire with self-diagnosis output, DC 2-wire with old pin arrangement	
		G	Connector Model DC 2-wire with IEC pin arrangement	
		J	Pre-wired Connector Model DC 3-wire and AC 2-wire, DC 2-wire with old pin arrangement	
		GJ	Pre-wired Connector Model DC 2-wire with IEC pin arrangement	
		TJ	Pre-wired Smartclick Connector Model DC 2-wire	
		TGJ	Pre-wired Smartclick Connector Model DC 2-wire with IEC pin arrangement	
⑩	DC 2-wire polarity	Blank	Polarity	
		T	No polarity	
⑪	Cable specifications	Blank	Standard PVC cable (oil resistant)	
		R	Flexible PVC cable (oil resistant)	
		U	Polyurethane cable (oil resistant and reinforced)	
⑫	New model	N	New model (Applies only to DC 2-wire pre-wired and shielded models.)	This is blank if the cable specification in number ⑪ is R or U.
	Standard-certified model	US	UL-recognized model (Applies to DC 2-wire pre-wired models and pre-wired connector models.)	
⑬	Cable length	Letter M	Cable length (Unit: m) (Applicable to Pre-wired Models and Pre-wired Connector Models.)	Example: 2M 0.3M

Note: The purpose of this model number legend is to provide understanding of the meaning of specifications from the model number. Models are not available for all combinations of code numbers.

## Ordering Information

## 2-Wire Models

Shielded DC 2-wire Models with No Self-diagnostic Output [Refer to *Dimensions* on page 27.]

Appearance	Sensing distance	Connection method	Cable specifications	Polarity	Operation mode	Pin arrangement	Applicable connector code *2	Model			
M8	2 mm	M12 Pre-wired Smart-click Connector Models (0.3m)	PUR (increased oil-resistant)	Yes	NO	1: +V, 4: 0 V	H	E2E-X2D1-M1TGJ-U 0.3M			
			PVC (oil-resistant)		NC	1: +V, 2: 0 V		E2E-X2D2-M1TGJ-U 0.3M			
			Pre-wired Models (2 m)		PUR (increased oil-resistant)	NO	1: +V, 4: 0 V	G	E2E-X2D1-M1TGJ 0.3M		
					PVC (oil-resistant)				NC	E2E-X2D1-U 2M	
					M12 Connector Models	---	NO	1: +V, 4: 0 V	A	E2E-X2D1-U 2M	
						---	NC			E2E-X2D2-U 2M	
		M8 Connector Models	---	NO	1: +V, 4: 0 V	I	E2E-X2D1-N 2M				
			---	NC			E2E-X2D2-N 2M				
		M12	3 mm	M12 Pre-wired Smart-click Connector Models (0.3m)	PUR (increased oil-resistant)	Yes	NO	1: +V, 4: 0 V	H	E2E-X3D1-M1TGJ-U 0.3M	
					PVC (oil-resistant)		NC	1: +V, 2: 0 V		E2E-X3D2-M1TGJ-U 0.3M	
					Pre-wired Models (2 m)		PUR (increased oil-resistant)	NO	1: +V, 4: 0 V	G	E2E-X3D1-M1TGJ 0.3M
							PVC (oil-resistant)				NC
M12 Connector Models	---						NO	1: +V, 4: 0 V	A	E2E-X3D2-U 2M	
	---						NC			E2E-X3D1-N 2M *1	
M12 Standard Pre-wired Connector Models (0.3 m)	PVC (oil-resistant)			NO	1: +V, 2: 0 V	D	E2E-X3D2-N 2M				
				NC			E2E-X3D1-M1G *1				
M12 Standard Pre-wired Connector Models (0.3 m)	PVC (oil-resistant)			NO	1: +V, 4: 0 V	A	E2E-X3D1-M1G *1				
				NC			1: +V, 2: 0 V	D	E2E-X3D2-M1G		
				NO	1: +V, 4: 0 V	A	E2E-X3D1-M1GJ 0.3M				
				NC			1: +V, 2: 0 V	D	E2E-X3D2-M1GJ 0.3M		
		No *3	NO	(3, 4): (+V, 0 V)	C	E2E-X3D1-M1J-T 0.3M					
			NC	(1, 2): (+V, 0 V)		D	---				
M18	7 mm	M12 Pre-wired Smart-click Connector Models (0.3m)	PUR (increased oil-resistant)	Yes	NO	1: +V, 4: 0 V	H	E2E-X7D1-M1TGJ-U 0.3M			
			PVC (oil-resistant)		NC	1: +V, 2: 0 V		E2E-X7D2-M1TGJ-U 0.3M			
			Pre-wired Models (2 m)		PUR (increased oil-resistant)	NO	1: +V, 4: 0 V	G	E2E-X7D1-M1TGJ 0.3M		
					PVC (oil-resistant)				NC	E2E-X7D1-U 2M	
					M12 Connector Models	---	NO	1: +V, 4: 0 V	A	E2E-X7D2-U 2M	
						---	NC			E2E-X7D1-N 2M *1	
		M12 Standard Pre-wired Connector Models (0.3 m)	PVC (oil-resistant)	NO	1: +V, 2: 0 V	D	E2E-X7D2-N 2M				
				NC			E2E-X7D1-M1G *1				
		M12 Standard Pre-wired Connector Models (0.3 m)	PVC (oil-resistant)	NO	1: +V, 4: 0 V	A	E2E-X7D1-M1G *1				
				NC			1: +V, 2: 0 V	D	E2E-X7D2-M1G		
				NO	1: +V, 4: 0 V	A	E2E-X7D1-M1GJ 0.3M				
				NC			1: +V, 2: 0 V	D	E2E-X7D2-M1GJ 0.3M		
No *3	NO			(3, 4): (+V, 0 V)	C	E2E-X7D1-M1J-T 0.3M					
	NC			(1, 2): (+V, 0 V)		D	E2E-X7D2-M1J-T 0.3M				
M30	10 mm	M12 Pre-wired Smart-click Connector Models (0.3m)	PUR (increased oil-resistant)	Yes	NO	1: +V, 4: 0 V	H	E2E-X10D1-M1TGJ-U 0.3M			
			PVC (oil-resistant)		NC	1: +V, 2: 0 V		E2E-X10D2-M1TGJ-U 0.3M			
			Pre-wired Models (2 m)		PUR (increased oil-resistant)	NO	1: +V, 4: 0 V	G	E2E-X10D1-M1TGJ 0.3M		
					PVC (oil-resistant)				NC	E2E-X10D1-U 2M	
					M12 Connector Models	---	NO	1: +V, 4: 0 V	A	E2E-X10D2-U 2M	
						---	NC			E2E-X10D1-N 2M *1	
		M12 Standard Pre-wired Connector Models (0.3 m)	PVC (oil-resistant)	NO	1: +V, 2: 0 V	D	E2E-X10D2-N 2M				
				NC			E2E-X10D1-M1G *1				
		M12 Standard Pre-wired Connector Models (0.3 m)	PVC (oil-resistant)	NO	1: +V, 4: 0 V	A	E2E-X10D1-M1G *1				
				NC			1: +V, 2: 0 V	D	E2E-X10D2-M1G		
				NO	1: +V, 4: 0 V	A	E2E-X10D1-M1GJ 0.3M				
				NC			1: +V, 2: 0 V	D	E2E-X10D2-M1GJ 0.3M		
No *3	NO			(3, 4): (+V, 0 V)	C	E2E-X10D1-M1J-T 0.3M					
	NC			(1, 2): (+V, 0 V)		D	E2E-X10D2-M1J-T 0.3M				

\*1. Models with different frequencies are also available. The model number is E2E-X □D15 (example: E2E-X3D15-N 2M).

\*2. Refer to page 22 for details.

\*3. The residual voltage for models without polarity is 5 V, so use caution concerning the connection load interface conditions (e.g., PLC ON voltage). Refer to page 26

## 2-Wire Models

Shielded DC 2-Wire UL-recognized Models with No Self-diagnostic Output [Refer to *Dimensions* on page 27.]



Appearance	Sensing distance		Connection method	Cable specifications	Polarity	Operation mode	Pin arrangement	Applicable connector code *	Model				
M8	2 mm		M12 Pre-wired Smart-click Connector Models (0.3 m)	PVC (oil-resistant)	Yes	NO	1: +V, 4: 0 V	G	E2E-X2D1-M1TGJ-US 0.3M				
			NC			1: +V, 2: 0 V	E2E-X2D2-M1TGJ-US 0.3M						
			NO			---	---	E2E-X2D1-US 2M					
			NC			---		E2E-X2D2-US 2M					
M12	3 mm		M12 Pre-wired Smart-click Connector Models (0.3 m)			PVC (oil-resistant)	Yes	NO	1: +V, 4: 0 V	G	E2E-X3D1-M1TGJ-US 0.3M		
			NC					1: +V, 2: 0 V	E2E-X3D2-M1TGJ-US 0.3M				
			NO					---	---	E2E-X3D1-US 2M			
			NC					---		E2E-X3D2-US 2M			
M18	7 mm		M12 Pre-wired Smart-click Connector Models (0.3 m)					PVC (oil-resistant)	Yes	NO	1: +V, 4: 0 V	G	E2E-X7D1-M1TGJ-US 0.3M
			NC							1: +V, 2: 0 V	E2E-X7D2-M1TGJ-US 0.3M		
			NO							---	---	E2E-X7D1-US 2M	
			NC							---		E2E-X7D2-US 2M	
M30	10 mm		M12 Pre-wired Smart-click Connector Models (0.3 m)	PVC (oil-resistant)	Yes					NO	1: +V, 4: 0 V	G	E2E-X10D1-M1TGJ-US 0.3M
			NC							1: +V, 2: 0 V	E2E-X10D2-M1TGJ-US 0.3M		
			NO							---	---	E2E-X10D1-US 2M	
			NC							---		E2E-X10D2-US 2M	

\* Refer to page 22 for details.

## 2-Wire Models

Unshielded DC 2-Wire Models with No Self-diagnosis Output [Refer to *Dimensions* on page 27.]



Appearance	Sensing distance		Connection method	Cable specifications	Polarity	Operation mode	Pin arrangement	Applicable connector code *2	Model		
M8	4 mm		Pre-wired Models (2 m)	PVC (oil-resistant)	Yes	NO	---	---	E2E-X4MD1 2M		
						NC			E2E-X4MD2 2M		
			M12 Connector Models	---		NO			1: +V, 4: 0 V	A	E2E-X4MD1-M1G
						NC			1: +V, 2: 0 V	D	E2E-X4MD2-M1G
			M8 Connector Models	---		NO			1: +V, 4: 0 V	I	E2E-X4MD1-M3G
						NC			1: +V, 2: 0 V		E2E-X4MD2-M3G
M12	8 mm		M12 Pre-wired Smart-click Connector Models (0.3m)	PVC (oil-resistant)	NO	1: +V, 4: 0 V	G	E2E-X8MD1-M1TGJ 0.3M			
			Pre-wired Models (2 m)	PVC (oil-resistant)	NO	---	---	E2E-X8MD1 2M *1			
					NC			E2E-X8MD2 2M			
			M12 Connector Models	---	NO	1: +V, 4: 0 V	A	E2E-X8MD1-M1G *1			
					NC	1: +V, 2: 0 V	D	E2E-X8MD2-M1G			
			M12 Standard Pre-wired Connector Models (0.3 m)	PVC (oil-resistant)	NO	1: +V, 4: 0 V	A	E2E-X8MD1-M1GJ 0.3M			
		NC	1: +V, 2: 0 V	D	---						
M18	14 mm		M12 Pre-wired Smart-click Connector Models (0.3m)	PVC (oil-resistant)	Yes	NO	1: +V, 4: 0 V	G	E2E-X14MD1-M1TGJ 0.3M		
			Pre-wired Models (2 m)	PVC (oil-resistant)	NO	---	---	E2E-X14MD1 2M *1			
					NC			E2E-X14MD2 2M			
			M12 Connector Models	---	NO	1: +V, 4: 0 V	A	E2E-X14MD1-M1G *1			
					NC	1: +V, 2: 0 V	D	E2E-X14MD2-M1G			
			M12 Standard Pre-wired Connector Models (0.3 m)	PVC (oil-resistant)	NO	1: +V, 4: 0 V	A	E2E-X14MD1-M1GJ 0.3M			
		NC	1: +V, 2: 0 V	D	E2E-X14MD2-M1GJ 0.3M						
M30	20 mm		M12 Pre-wired Smart-click Connector Models (0.3m)	PVC (oil-resistant)		NO	1: +V, 4: 0 V	G	E2E-X20MD1-M1TGJ 0.3M		
			Pre-wired Models (2 m)	PVC (oil-resistant)	NO	---	---	E2E-X20MD1 2M *1			
					NC			E2E-X20MD2 2M			
			M12 Connector Models	---	NO	1: +V, 4: 0 V	A	E2E-X20MD1-M1G *1			
					NC	1: +V, 2: 0 V	D	E2E-X20MD2-M1G			
			M12 Standard Pre-wired Connector Models (0.3 m)	PVC (oil-resistant)	NO	1: +V, 4: 0 V	A	E2E-X20MD1-M1GJ 0.3M			
		NC	1: +V, 2: 0 V	D	---						

\*1. Models with different frequencies are also available. The model number is E2E-X□D15 (example: E2E-X8MD15 2M).

\*2. Refer to page 22 for details.



2-Wire Models

Unshielded DC 2-Wire UL-recognized Models with No Self-diagnostic Output [Refer to Dimensions on page 27.]



Appearance	Sensing distance		Connection method	Cable specifications	Polarity	Operation mode	Pin arrangement	Applicable connector code *	Model				
M8	4 mm		M12 Pre-wired Smart-click Connector Models (0.3 m)	PVC (oil-resistant)	Yes	NO	1: +V, 4: 0 V	G	E2E-X4MD1-M1TGJ-US 0.3M				
			NC			1: +V, 2: 0 V	E2E-X4MD2-M1TGJ-US 0.3M						
			NO			---	---	E2E-X4MD1-US 2M					
			NC			---		E2E-X4MD2-US 2M					
M12	8 mm		M12 Pre-wired Smart-click Connector Models (0.3 m)			PVC (oil-resistant)	Yes	NO	1: +V, 4: 0 V	G	E2E-X8MD1-M1TGJ-US 0.3M		
			NC					1: +V, 2: 0 V	E2E-X8MD2-M1TGJ-US 0.3M				
			NO					---	---	E2E-X8MD1-US 2M			
			NC					---		E2E-X8MD2-US 2M			
M18	14 mm		M12 Pre-wired Smart-click Connector Models (0.3 m)					PVC (oil-resistant)	Yes	NO	1: +V, 4: 0 V	G	E2E-X14MD1-M1TGJ-US 0.3M
			NC							1: +V, 2: 0 V	E2E-X14MD2-M1TGJ-US 0.3M		
			NO							---	---	E2E-X14MD1-US 2M	
			NC							---		E2E-X14MD2-US 2M	
M30	20 mm		M12 Pre-wired Smart-click Connector Models (0.3 m)	PVC (oil-resistant)	Yes					NO	1: +V, 4: 0 V	G	E2E-X20MD1-M1TGJ-US 0.3M
			NC							1: +V, 2: 0 V	E2E-X20MD2-M1TGJ-US 0.3M		
			NO							---	---	E2E-X20MD1-US 2M	
			NC							---		E2E-X20MD2-US 2M	

\* Refer to page 22 for details.

Shielded DC 2-Wire Models with Self-diagnosis Output [Refer to Dimensions on page 27.]



Appearance	Sensing distance		Connection method	Cable specifications	Polarity	Operation mode	Pin arrangement	Applicable connector code *2	Model				
M12	3 mm		Pre-wired Models (2 m)	PVC (oil-resistant)	Yes	NO	---	---	E2E-X3D1S 2M *1				
			M12 Connector Models	---			2: +V and diagnostic output 3: 0 V 4: +V and control output	D	E2E-X3D1S-M1				
M18	7 mm		Pre-wired Models (2 m)	PVC (oil-resistant)			Yes	NO	---	---	E2E-X7D1S 2M *1		
			M12 Connector Models	---					2: +V and diagnostic output 3: 0 V 4: +V and control output	D	E2E-X7D1S-M1		
M30	10 mm		Pre-wired Models (2 m)	PVC (oil-resistant)					Yes	NO	---	---	E2E-X10D1S 2M *1
			M12 Connector Models	---							2: +V and diagnostic output 3: 0 V 4: +V and control output	D	E2E-X10D1S-M1

\*1. Models with different frequencies are also available. The model number is E2E-X □D15S (example: E2E-X3D15S 2M).

\*2. Refer to page 22 for details.

2-Wire Models

Unshielded DC 2-Wire Models with Self-diagnosis Output [Refer to Dimensions on page 27.]



Appearance	Sensing distance	Connection method	Cable specifications	Polarity	Operation mode	Pin arrangement	Applicable connector code *2	Model		
M12	8 mm	Pre-wired Models (2 m)	PVC (oil-resistant)	Yes	NO	---	---	E2E-X8MD1S 2M *1		
		M12 Connector Models	---			2: +V and diagnostic output 3: 0 V 4: +V and control output	D	E2E-X8MD1S-M1		
M18	14 mm	Pre-wired Models (2 m)	PVC (oil-resistant)			---	---	---	---	E2E-X14MD1S 2M *1
		M12 Connector Models	---			2: +V and diagnostic output 3: 0 V 4: +V and control output	D	E2E-X14MD1S-M1		
M30	20 mm	Pre-wired Models (2 m)	PVC (oil-resistant)			---	---	---	---	E2E-X20MD1S 2M *1
		M12 Connector Models	---			2: +V and diagnostic output 3: 0 V 4: +V and control output	D	E2E-X20MD1S-M1		

\*1. Models with different frequencies are also available. The model number is E2E-X□MD15S (example: E2E-X8MD15S 2M).

\*2. Refer to page 22 for details.

Connector Pin Assignments of DC 2-Wire Models

- The connector pin assignments of each New E2E DC 2-Wire Model conform to IEC 947-5-2 Table III. (Only DC 2-Wire Models have been changed in comparison to the previous models.)
- The following models with conventional connector pin assignments are available as well. (Only NO Models can be used.)  
The cable at the right should also be used if the XW3A-P□45-G11 Connector Junction Box is already being used.

Cable length	Model
500 mm	XS2W-D421-BY1

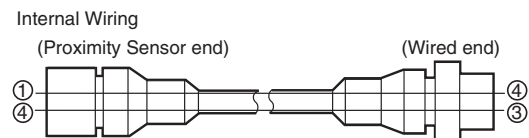

Models with conventional connector pin assignments are available as well.

Appearance		Model			
		NO	Applicable connector code *	NC	Applicable connector code *
Shielded	M8	E2E-X2D1-M1	C	E2E-X2D2-M1	D
	M12	E2E-X3D1-M1	C	E2E-X3D2-M1	D
	M18	E2E-X7D1-M1	C	E2E-X7D2-M1	D
	M30	E2E-X10D1-M1	C	E2E-X10D2-M1	D
Unshielded	M8	E2E-X4MD1-M1	C	E2E-X4MD2-M1	D
	M12	E2E-X8MD1-M1	C	E2E-X8MD2-M1	D
	M18	E2E-X14MD1-M1	C	E2E-X14MD2-M1	D
	M30	E2E-X20MD1-M1	C	E2E-X20MD2-M1	D

\* Refer to page 22 for details.

## 2-Wire Models

### AC 2-Wire Models Shielded Models [Refer to *Dimensions* on page 27.]



Appearance	Sensing distance		Connection method	Cable specifications	Operation mode	Pin arrangement	Applicable connector code *2	Model
M8	1.5 mm		Pre-wired Models (2 m)	PVC (oil-resistant)	NO	---	---	E2E-X1R5Y1 2M
					NC			E2E-X1R5Y2 2M
M12	2 mm		Pre-wired Models (2 m)	PVC (oil-resistant)	NO	---	---	E2E-X2Y1 2M *1
					NC			E2E-X2Y2 2M
			M12 Connector Models	---	NO	(3, 4): (AC, AC)	E	E2E-X2Y1-M1
					NC	(1, 2): (AC, AC)	F	E2E-X2Y2-M1
M18	5 mm		Pre-wired Models (2 m)	PVC (oil-resistant)	NO	---	---	E2E-X5Y1 2M *1
					NC			E2E-X5Y2 2M
			M12 Connector Models	---	NO	(3, 4): (AC, AC)	E	E2E-X5Y1-M1
					NC	(1, 2): (AC, AC)	F	E2E-X5Y2-M1
M30	10 mm		Pre-wired Models (2 m)	PVC (oil-resistant)	NO	---	---	E2E-X10Y1 2M *1
					NC			E2E-X10Y2 2M
			M12 Connector Models	---	NO	(3, 4): (AC, AC)	E	E2E-X10Y1-M1
					NC	(1, 2): (AC, AC)	F	E2E-X10Y2-M1

\*1. Models with different frequencies are also available. The model number is E2E-X □□□5 (example: E2E-X5Y15 2M).

\*2. Refer to page 22 for details.

### Unshielded Models



Appearance	Sensing distance		Connection method	Cable specifications	Operation mode	Pin arrangement	Applicable connector code *2	Model
M8	2 mm		Pre-wired Models (2 m)	PVC (oil-resistant)	NO	---	---	E2E-X2MY1 2M
					NC			E2E-X2MY2 2M
M12	5 mm		Pre-wired Models (2 m)	PVC (oil-resistant)	NO	---	---	E2E-X5MY1 2M *1
					NC			E2E-X5MY2 2M
			M12 Connector Models	---	NO	(3, 4): (AC, AC)	E	E2E-X5MY1 2M
					NC	(1, 2): (AC, AC)	F	E2E-X5MY2-M1
M18	10 mm		Pre-wired Models (2 m)	PVC (oil-resistant)	NO	---	---	E2E-X10MY1 2M *1
					NC			E2E-X10MY2 2M
			M12 Connector Models	---	NO	(3, 4): (AC, AC)	E	E2E-X10MY1-M1
					NC	(1, 2): (AC, AC)	F	E2E-X10MY2-M1
M30	18 mm		Pre-wired Models (2 m)	PVC (oil-resistant)	NO	---	---	E2E-X18MY1 2M *1
					NC			E2E-X18MY2 2M
			M12 Connector Models	---	NO	(3, 4): (AC, AC)	E	E2E-X18MY1-M1
					NC	(1, 2): (AC, AC)	F	E2E-X18MY2-M1

\*1. Models with different frequencies are also available. The model number is E2E-X □□MY□5 (example: E2E-X5MY15 2M).

\*2. Refer to page 22 for details.

### AC 2-Wire Models Shielded Models [Refer to *Dimensions* on page 27.]

(There are no unshielded models.)



Appearance	Sensing distance		Connection method	Cable specifications	Operation mode	Pin arrangement	Applicable connector code	Model
M12	3 mm		Pre-wired Models (2 m)	PVC (oil-resistant)	NO	---	---	E2E-X3T1 2M
M18	7 mm		Pre-wired Models (2 m)	PVC (oil-resistant)		---	---	E2E-X7T1 2M
M30	10 mm		Pre-wired Models (2 m)	PVC (oil-resistant)		---	---	E2E-X10T1 2M

## 3-Wire Models

Shielded DC 3-Wire Models [Refer to *Dimensions* on page 27.]

Appearance	Sensing distance			Connection method	Cable specifications	Operation mode	Pin arrangement	Applicable connector code *2	Model	
									NPN output	PNP output
M8	1.5 mm			Pre-wired Models (2 m)	PVC (oil-resistant)	NO	---	---	E2E-X1R5E1 2M	E2E-X1R5F1 2M
					PVC (oil-resistant)	NC			E2E-X1R5E2 2M	E2E-X1R5F2 2M
				M12 Connector Models	---	NO	1: +V, 3: 0 V, 4: Control output	B	E2E-X1R5E1-M1	E2E-X1R5F1-M1
						NC	1: +V, 3: 0 V, 2: Control output	D	E2E-X1R5E2-M1	E2E-X1R5F2-M1
				M8 Connector Models	---	NO	1: +V, 3: 0 V, 4: Control output	I	E2E-X1R5E1-M3	E2E-X1R5F1-M3
						NC	1: +V, 3: 0 V, 2: Control output		E2E-X1R5E2-M3	E2E-X1R5F2-M3
M12	2 mm			Pre-wired Models (2 m)	PVC (oil-resistant)	NO	---	---	E2E-X2E1 2M *1	E2E-X2F1 2M *1
						NC			E2E-X2E2 2M	E2E-X2F2 2M
				M12 Connector Models	---	NO	1: +V, 3: 0 V, 4: Control output	B	E2E-X2E1-M1	E2E-X2F1-M1
						NC	1: +V, 3: 0 V, 2: Control output	D	E2E-X2E2-M1	E2E-X2F2-M1
M18	5 mm			Pre-wired Models (2 m)	PVC (oil-resistant)	NO	---	---	E2E-X5E1 2M *1	E2E-X5F1 2M *1
						NC			E2E-X5E2 2M	E2E-X5F2 2M
				M12 Connector Models	---	NO	1: +V, 3: 0 V, 4: Control output	B	E2E-X5E1-M1	E2E-X5F1-M1
						NC	1: +V, 3: 0 V, 2: Control output	D	E2E-X5E2-M1	E2E-X5F2-M1
M30	10 mm			Pre-wired Models (2 m)	PVC (oil-resistant)	NO	---	---	E2E-X10E1 2M *1	E2E-X10F1 2M
						NC			E2E-X10E2 2M	E2E-X10F2 2M
				M12 Connector Models	---	NO	1: +V, 3: 0 V, 4: Control output	B	E2E-X10E1-M1	E2E-X10F1-M1
						NC	1: +V, 3: 0 V, 2: Control output	D	E2E-X10E2-M1	E2E-X10F2-M1

\*1. Models with different frequencies are also available. The model number is E2E-X□□□5 (example: E2E-X5E15 2M).

\*2. Refer to page 22 for details.

## 3-Wire Models

Unshielded DC 3-Wire Models [Refer to *Dimensions* on page 27.]

Appearance	Sensing distance			Connection method	Cable specifications	Operation mode	Pin arrangement	Applicable connector code *2	Model	
									NPN output	PNP output
M8	2 mm			Pre-wired Models (2 m)	PVC (oil-resistant)	NO	---	---	E2E-X2ME1 2M	E2E-X2MF1 2M
						NC			E2E-X2ME2 2M	E2E-X2MF2 2M
				M12 Connector Models	---	NO	1: +V, 3: 0 V, 4: Control output	B	E2E-X2ME1-M1	E2E-X2MF1-M1
						NC	1: +V, 3: 0 V, 2: Control output	D	E2E-X2ME2-M1	E2E-X2MF2-M1
				M8 Connector Models	---	NO	1: +V, 3: 0 V, 4: Control output	I	E2E-X2ME1-M3	E2E-X2MF1-M3
						NC	1: +V, 3: 0 V, 2: Control output		E2E-X2ME2-M3	E2E-X2MF2-M3
M12	5 mm			Pre-wired Models (2 m)	PVC (oil-resistant)	NO	---	---	E2E-X5ME1 2M *1	E2E-X5MF1 2M
						NC			E2E-X5ME2 2M	E2E-X5MF2 2M
				M12 Connector Models	---	NO	1: +V, 3: 0 V, 4: Control output	B	E2E-X5ME1-M1	E2E-X5MF1-M1
						NC	1: +V, 3: 0 V, 2: Control output	D	E2E-X5ME2-M1	E2E-X5MF2-M1
M18	10 mm			Pre-wired Models (2 m)	PVC (oil-resistant)	NO	---	---	E2E-X10ME1 2M *1	E2E-X10MF1 2M
						NC			E2E-X10ME2 2M	E2E-X10MF2 2M
				M12 Connector Models	---	NO	1: +V, 3: 0 V, 4: Control output	B	E2E-X10ME1-M1	E2E-X10MF1-M1
						NC	1: +V, 3: 0 V, 2: Control output	D	E2E-X10ME2-M1	E2E-X10MF2-M1
M30	18 mm			Pre-wired Models (2 m)	PVC (oil-resistant)	NO	---	---	E2E-X18ME1 2M *1	E2E-X18MF1 2M
						NC			E2E-X18ME2 2M	E2E-X18MF2 2M
				M12 Connector Models	---	NO	1: +V, 3: 0 V, 4: Control output	B	E2E-X18ME1-M1	E2E-X18MF1-M1
						NC	1: +V, 3: 0 V, 2: Control output	D	E2E-X18ME2-M1	E2E-X18MF2-M1

\*1. Models with different frequencies are also available. The model number is E2E-X□M□□5 (example: E2E-X5ME15 2M).

\*2. Refer to page 22 for details.

## Ratings and Specifications

### E2E-X□D□ DC 2-Wire Models

Item	Size		M8		M12		M18		M30								
	Shielded Model	Unshielded Model	Shielded	Unshielded	Shielded	Unshielded	Shielded	Unshielded	Shielded	Unshielded							
			E2E-X2D□	E2E-X4MD□	E2E-X3D□	E2E-X8MD□	E2E-X7D□	E2E-X14MD□	E2E-X10D□	E2E-X20MD□							
<b>Sensing distance</b>	2 mm ±10%		4 mm ±10%		3 mm ±10%		8 mm ±10%		7 mm ±10%		14 mm ±10%		10 mm ±10%		20 mm ±10%		
<b>Set distance *1</b>	0 to 1.6 mm		0 to 3.2 mm		0 to 2.4 mm		0 to 6.4 mm		0 to 5.6 mm		0 to 11.2 mm		0 to 8 mm		0 to 16 mm		
<b>Differential travel</b>	15% max. of sensing distance				10% max. of sensing distance												
<b>Detectable object</b>	Ferrous metal (The sensing distance decreases with non-ferrous metal. Refer to <i>Engineering Data</i> on pages 17 and 18.																
<b>Standard sensing object</b>	Iron, 8 × 8 × 1 mm		Iron, 20 × 20 × 1 mm		Iron, 12 × 12 × 1 mm		Iron, 30 × 30 × 1 mm		Iron, 18 × 18 × 1 mm		Iron, 30 × 30 × 1 mm		Iron, 54 × 54 × 1 mm				
<b>Response frequency *2</b>	1.5 kHz		1 kHz		0.8 kHz		0.5 kHz		0.4 kHz				0.1 kHz				
<b>Power supply voltage (operating voltage range)</b>	Standard Models: 12 to 24 VDC, ripple (p-p): 10% max. (10 to 30 VDC) US Models and Connector Models Used as UL-certified Models: 12 to 24 VDC, ripple (p-p): 10% max. (The operating voltage range is also the same.) *3																
<b>Leakage current</b>	0.8 mA max.																
<b>Control output</b>	<b>Load current</b>	3 to 100 mA, Diagnostic output: 50 mA for -D1(5)S Models															
	<b>Residual voltage *4</b>	3 V max. (Load current: 100 mA, Cable length: 2 m, M1J-T Models only: 5 V max.)															
<b>Indicators</b>	D1 Models: Operation indicator (red) and setting indicator (green) D2 Models: Operation indicator (red)																
<b>Operation mode (with sensing object approaching)</b>	D1 Models: NO      Refer to the timing charts under <i>I/O Circuit Diagrams</i> on page 20 for details. D2 Models: NC																
<b>Diagnostic output delay</b>	0.3 to 1 s																
<b>Protection circuits</b>	Surge suppressor, Load short-circuit protection (for control and diagnostic output)																
<b>Ambient temperature range</b>	Operating: -25 to 70°C, Storage: -40 to 85°C (with no icing or condensation)																
<b>Ambient humidity range</b>	Operating/storage: 35% to 95% (with no condensation)																
<b>Temperature influence</b>	±15% max. of sensing distance at 23°C in the temperature range of -25 to 70°C				±10% max. of sensing distance at 23°C in the temperature range of -25 to 70°C												
<b>Voltage influence</b>	±1% max. of sensing distance at rated voltage in the rated voltage ±15% range																
<b>Insulation resistance</b>	50 MΩ min. (at 500 VDC) between current-carrying parts and case																
<b>Dielectric strength</b>	1000 VAC, 50/60 Hz for 1 minute between current carry parts and case																
<b>Vibration resistance</b>	Destruction: 10 to 55 Hz, 1.5-mm double amplitude for 2 hours each in X, Y, and Z directions																
<b>Shock resistance</b>	Destruction: 500 m/s <sup>2</sup> 10 times each in X, Y, and Z directions				Destruction: 1,000 m/s <sup>2</sup> 10 times each in X, Y, and Z directions												
<b>Degree of protection</b>	Pre-wired Models: IEC 60529 IP67, in-house standards: oil-resistant Connector Models: IEC 60529 IP67																
<b>Connection method</b>	Pre-wired Models (Standard cable length: 2 m), Connector Models, or Pre-wired Connector Models (Standard cable length: 0.3 m)																
<b>Weight (packed state)</b>	<b>Pre-wired Models</b>	Approx. 60 g				Approx. 70 g				Approx. 130 g				Approx. 175 g			
	<b>Pre-wired Connector Models</b>	---				Approx. 40 g				Approx. 70 g				Approx. 110 g			
	<b>Connector Models</b>	Approx. 15 g				Approx. 25 g				Approx. 40 g				Approx. 90 g			
<b>Materials</b>	<b>Case</b>	Stainless steel (SUS303)				Nickel-plated brass											
	<b>Sensing surface</b>	PBT															
	<b>Clamping nuts</b>	Nickel-plated brass															
	<b>Toothed washer</b>	Zinc-plated iron															
<b>Accessories</b>	Instruction manual																

\*1. Use the E2E within the range in which the setting indicator (green LED) is ON (except D2 Models).

\*2. The response frequency is an average value.

Measurement conditions are as follows: standard sensing object, a distance of twice the standard sensing object, and a set distance of half the sensing distance.

\*3. For the information on UL-certified connector models, refer to your OMRON website.

\*4. The residual voltage of each M1J-T Model is 5 V. When connecting to a device, make sure that the device can withstand the residual voltage. (Refer to page 26 for details.)

## E2E-X□Y□ AC 2-Wire Models

Item	Size		M8		M12		M18		M30			
	Shielded	Model	Shielded	Unshielded	Shielded	Unshielded	Shielded	Unshielded	Shielded	Unshielded		
			E2E-X1R5Y□	E2E-X2MY□	E2E-X2Y□	E2E-X5MY□	E2E-X5Y□	E2E-X10MY□	E2E-X10Y□	E2E-X18MY□		
<b>Sensing distance</b>			1.5 mm ±10%		2 mm ±10%		5 mm ±10%		10 mm ±10%		18 mm ±10%	
<b>Set distance</b>			0 to 1.2 mm		0 to 1.6 mm		0 to 4 mm		0 to 8 mm		0 to 14 mm	
<b>Differential travel</b>			10% max. of sensing distance									
<b>Detectable object</b>	Ferrous metal (The sensing distance decreases with non-ferrous metal. Refer to <i>Engineering Data</i> on page 18.)											
<b>Standard sensing object</b>			Iron, 8 × 8 × 1 mm		Iron, 12 × 12 × 1 mm		Iron, 15 × 15 × 1 mm		Iron, 18 × 18 × 1 mm		Iron, 30 × 30 × 1 mm	Iron, 54 × 54 × 1 mm
<b>Response frequency</b>	25 Hz											
<b>Power supply voltage (operating voltage range)<sup>*1</sup></b>	24 to 240 VAC (20 to 264 VAC), 50/60 Hz											
<b>Leakage current</b>	1.7 mA max.											
<b>Control output</b>	<b>Load current<sup>*2</sup></b>	5 to 100 mA			5 to 200 mA			5 to 300 mA				
	<b>Residual voltage</b>	Refer to <i>Engineering Data</i> on page 19.										
<b>Indicators</b>	Operation indicator (red)											
<b>Operation mode (with sensing object approaching)</b>	Y1 Models: NO    Y2 Models: NC    Refer to the timing charts under <i>I/O Circuit Diagrams</i> on page 21 for details.											
<b>Protection circuits</b>	Surge suppressor											
<b>Ambient temperature range<sup>*1*2</sup></b>	Operating/Storage: -25 to 70°C (with no icing or condensation)				Operating/Storage: -40 to 85°C (with no icing or condensation)							
<b>Ambient humidity range</b>	Operating/storage: 35% to 95% (with no condensation)											
<b>Temperature influence</b>	±10% max. of sensing distance at 23°C in the temperature range of -25 to 70°C				±15% max. of sensing distance at 23°C in the temperature range of -40 to 85°C, ±10% max. of sensing distance at 23°C in the temperature range of -25 to 70°C							
<b>Voltage influence</b>	±1% max. of sensing distance at rated voltage in the rated voltage ±15% range											
<b>Insulation resistance</b>	50 MΩ min. (at 500 VDC) between current-carrying parts and case											
<b>Dielectric strength</b>	4,000 VAC (M8 Models: 2,000 VAC), 50/60 Hz for 1 min between current-carrying parts and case											
<b>Vibration resistance</b>	Destruction: 10 to 55 Hz, 1.5-mm double amplitude for 2 hours each in X, Y, and Z directions											
<b>Shock resistance</b>	Destruction: 500 m/s <sup>2</sup> 10 times each in X, Y, and Z directions				Destruction: 1,000 m/s <sup>2</sup> 10 times each in X, Y, and Z directions							
<b>Degree of protection</b>	Pre-wired Models: IEC 60529 IP67, in-house standards: oil-resistant Connector Models: IEC 60529 IP67											
<b>Connection method</b>	Pre-wired Models (Standard cable length: 2 m) and Connector Models											
<b>Weight (packed state)</b>	<b>Pre-wired Models Model</b>	Approx. 60 g			Approx. 70 g			Approx. 130 g		Approx. 175 g		
	<b>Connector Models</b>	Approx. 15 g			Approx. 25 g			Approx. 40 g		Approx. 90 g		
<b>Materials</b>	<b>Case</b>	Stainless steel (SUS303)			Nickel-plated brass							
	<b>Sensing surface</b>	PBT										
	<b>Clamping nuts</b>	Nickel-plated brass										
	<b>Toothed washer</b>	Zinc-plated iron										
<b>Accessories</b>	Instruction manual											

\*1. When supplying 24 VAC to any of the above models, make sure that the operating ambient temperature range is at least -25°C.

\*2. When using an M18 or M30 Connector Model at an ambient temperature between 70 and 85°C, make sure that the Sensor has a control output (load current) of 5 to 200 mA max.

## E2E-X□T1 AC/DC 2-Wire Models

Item	Size Shielded Model	M12	M18	M30
		Shielded		
		E2E-X3T1	E2E-X7T1	E2E-X10T1
Sensing distance		3 mm ±10%	7 mm ±10%	10 mm ±10%
Set distance		0 to 2.4 mm	0 to 5.6 mm	0 to 8 mm
Differential travel		10% max. of sensing distance		
Detectable object		Ferrous metal (The sensing distance decreases with non-ferrous metal. Refer to <i>Engineering Data</i> on page 17.)		
Standard sensing object		Iron, 12 × 12 × 1 mm	Iron, 18 × 18 × 1 mm	Iron, 30 × 30 × 1 mm
Response frequency *1	DC	1 kHz	0.5 kHz	0.4 kHz
	AC	25 Hz		
Power supply voltage (operating voltage range) *2		24 to 240 VDC (20 to 264 VDC) 48 to 240 VAC (40 to 264 VAC)		
Leakage current		DC: 1 mA max. AC: 2 mA max.		
Control output	Load current	5 to 100 mA		
	Residual voltage	DC: 6 V max. (Load current: 100 mA, Cable length: 2 m) AC: 10 V max. (Load current: 5 mA, Cable length: 2 m)		
Indicators		Operation indicator (red), Setting indicator (green)		
Operation mode (with sensing object approaching)		NO (Refer to the timing charts under <i>I/O Circuit Diagrams</i> on page 21 for details.)		
Protection circuits		Load short-circuit protection (20 to 40 VDC only), Surge suppressor		
Ambient temperature range		Operating: -25 to 70°C, Storage: -40 to 85°C (with no icing or condensation)		
Ambient humidity range		Operating/Storage: 35% to 95% (with no condensation)		
Temperature influence		±10% max. of sensing distance at 23°C in the temperature range of -25 to 70°C		
Voltage influence		±1% max. of sensing distance at rated voltage in the rated voltage ±15% range		
Insulation resistance		50 MΩ min. (at 500 VDC) between current-carrying parts and case		
Dielectric strength		4,000 VAC, 50/60 Hz for 1 minute between current-carrying parts and case		
Vibration resistance		Destruction: 10 to 55 Hz, 1.5-mm double amplitude for 2 hours each in X, Y, and Z directions		
Shock resistance		Destruction: 1,000 m/s <sup>2</sup> 10 times each in X, Y, and Z directions		
Degree of protection		IEC 60529 IP67, in-house standards: oil-resistant		
Connection method		Pre-wired Models (Standard cable length: 2 m)		
Weight (packed state)		Approx. 80 g	Approx. 140 g	Approx. 190 g
Materials	Case	Nickel-plated brass		
	Sensing surface	PBT		
	Clamping nuts	Nickel-plated brass		
	Toothed washer	Zinc-plated iron		
Accessories		Instruction manual		

\*1. The response frequency is an average value. Measurement conditions are as follows: standard sensing object, a distance of twice the standard sensing object, and a set distance of half the sensing distance.

\*2. Power Supply Voltage Waveform:

Use a sine wave for the power supply. Using a rectangular AC power supply may result in faulty reset.



## E2E-X□E□/F□ DC 3-Wire Models

Item	Size Shielded Model	M8		M12		M18		M30		
		Shielded	Unshielded	Shielded	Unshielded	Shielded	Unshielded	Shielded	Unshielded	
		E2E -X1R5E□/F□	E2E -X2ME□/F□	E2E -X2E□/F□	E2E -X5ME□/F□	E2E -X5E□/F□	E2E -X10ME□/F□	E2E-X10E□/ F□	E2E -X18ME□/F□	
<b>Sensing distance</b>		1.5 mm ±10%	2 mm ±10%		5 mm ±10%		10 mm ±10%		18 mm ±10%	
<b>Set distance</b>		0 to 1.2 mm	0 to 1.6 mm		0 to 4 mm		0 to 8 mm		0 to 14 mm	
<b>Differential travel</b>		10% max. of sensing distance								
<b>Detectable object</b>		Ferrous metal (The sensing distance decreases with non-ferrous metal. Refer to <i>Engineering Data</i> on page 18.)								
<b>Standard sensing object</b>		Iron, 8 × 8 × 1 mm	Iron, 12 × 12 × 1 mm		Iron, 15 × 15 × 1 mm	Iron, 18 × 18 × 1 mm	Iron, 30 × 30 × 1 mm		Iron, 54 × 54 × 1 mm	
<b>Response frequency *1</b>		2 kHz	0.8 kHz	1.5 kHz	0.4 kHz	0.6 kHz	0.2 kHz	0.4 kHz	0.1 kHz	
<b>Power supply voltage (operating voltage range) *2</b>		12 to 24 VDC, ripple(p-p): 10% max. (10 to 30 VDC) Connector Models Used as UL-certified Models: 12 to 24 VDC, ripple (p-p): 10% max. (The operating voltage range is also the same.) *3								
<b>Current consumption</b>		13 mA max.								
<b>Control output</b>	<b>Load current *2</b>	200 mA max.								
	<b>Residual voltage</b>	2 V max. (Load current: 200 mA, Cable length: 2 m)								
<b>Indicators</b>		Operation indicator (red)								
<b>Operation mode (with sensing object approaching)</b>		E1/F1 Models: NO E2/F2 Models: NC Refer to the timing charts under <i>/O Circuit Diagrams</i> on page 21 for details.								
<b>Protection circuits</b>		Load short-circuit protection, Surge suppressor, Reverse polarity protection								
<b>Ambient temperature range *2</b>		Operating/Storage: -40 to 85°C (with no icing or condensation)								
<b>Ambient humidity range</b>		Operating/Storage: 35% to 95% (with no condensation)								
<b>Temperature influence</b>		±15% max. of sensing distance at 23°C in the temperature range of -40 to 85°C ±10% max. of sensing distance at 23°C in the temperature range of -25 to 70°C								
<b>Voltage influence</b>		±1% max. of sensing distance at rated voltage in the rated voltage ±15% range								
<b>Insulation resistance</b>		50 MΩ min. (at 500 VDC) between current-carrying parts and case								
<b>Dielectric strength</b>		1,000 VAC, 50/60 Hz for 1 minute between current carry parts and case								
<b>Vibration resistance</b>		Destruction: 10 to 55 Hz, 1.5-mm double amplitude for 2 hours each in X, Y, and Z directions								
<b>Shock resistance</b>		Destruction: 500 m/s <sup>2</sup> 10 times each in X, Y, and Z directions			Destruction: 1,000 m/s <sup>2</sup> 10 times each in X, Y, and Z directions					
<b>Degree of protection</b>		Pre-wired Models : IEC 60529 IP67, in-house standards: oil-resistant Connector Models : IEC 60529 IP67								
<b>Connection method</b>		Pre-wired Models (Standard cable length: 2 m) and Connector Models								
<b>Weight (packed state)</b>	<b>Pre-wired Models</b>	Approx. 65 g		Approx. 75 g		Approx. 150 g		Approx. 195 g		
	<b>Connector Models</b>	Approx. 15 g		Approx. 25 g		Approx. 40 g		Approx. 90 g		
<b>Materials</b>	<b>Case</b>	Stainless steel (SUS303)		Nickel-plated brass						
	<b>Sensing surface</b>	PBT								
	<b>Clamping nuts</b>	Nickel-plated brass								
	<b>Toothed washer</b>	Zinc-plated iron								
<b>Accessories</b>		Instruction manual								

\*1. The response frequency is an average value. Measurement conditions are as follows: standard sensing object, a distance of twice the standard sensing object, and a set distance of half the sensing distance.

\*2. When using an M8 Model at an ambient temperature between 70 and 85°C, supply 10 to 30 VDC to the Sensor and make sure that the Sensor has a control output of 100 mA maximum.

\*3. For the information on UL-certified connector models, refer to your OMRON website.

# Engineering Data (Reference Value)

## Sensing Area

### Shielded Models

E2E-X□D□/-X□T1

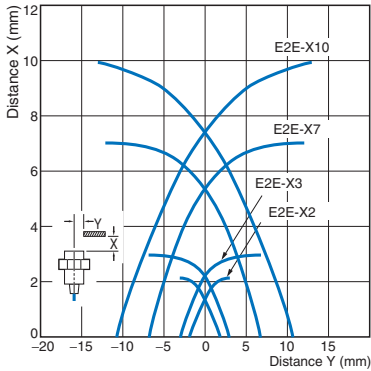

E2E-X□E□/-X□Y□/-X□F□

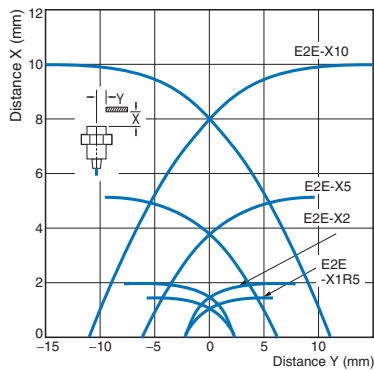

### Unshielded Models

E2E-X□MD□

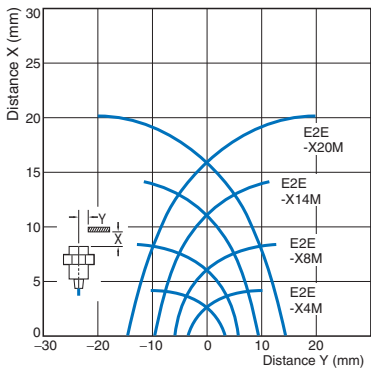

E2E-X□ME□/-X□MY□/-X□MF□

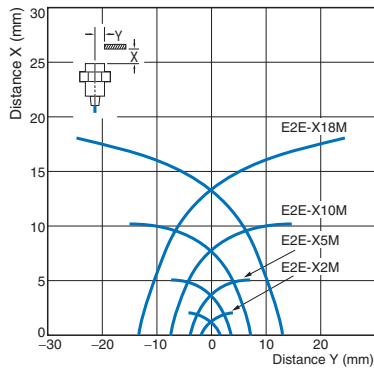

## Influence of Sensing Object Size and Material

E2E-X2D□

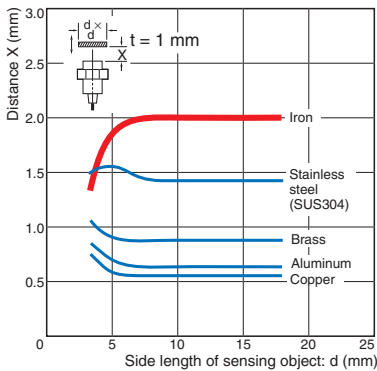

E2E-X3D□/-X3T1

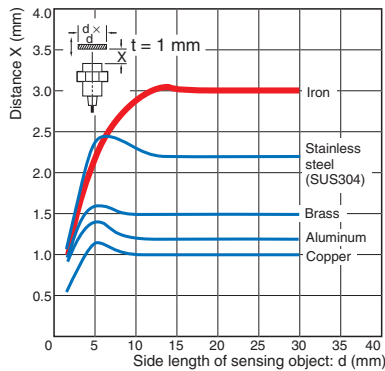

E2E-X7D□/-X7T1

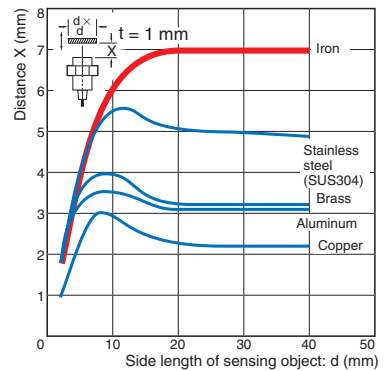

E2E-X10D□/-X10T1

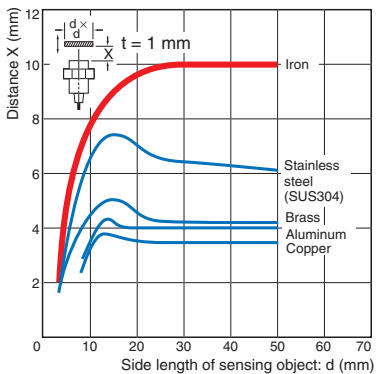

E2E-X4MD□

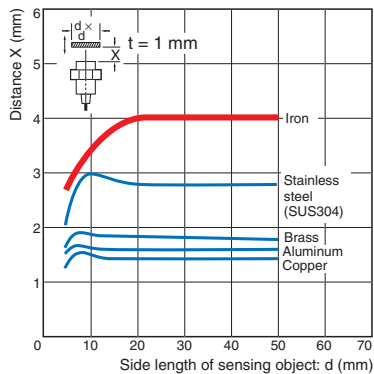

E2E-X8MD□

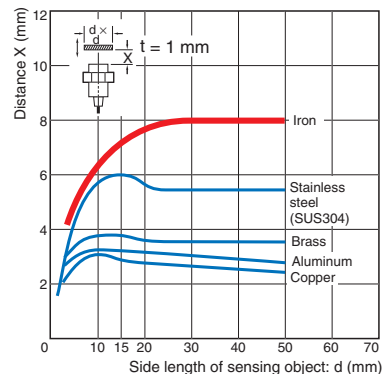

**E2E-X14MD**

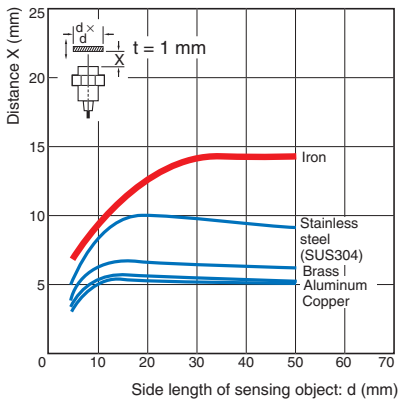

**E2E-X20MD**

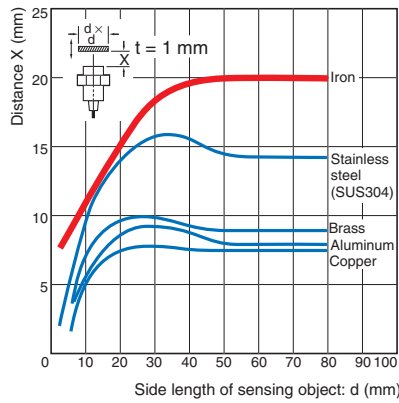

**E2E-X1R5E/-X1R5Y/-X1R5F**

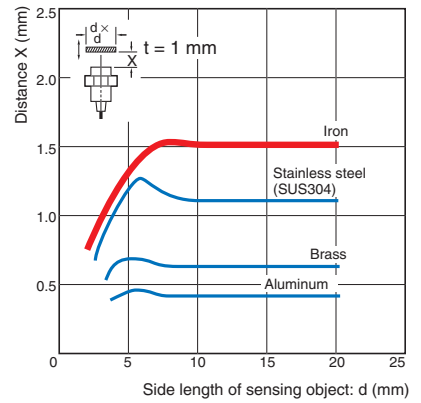

**E2E-X2E/-X2Y/-X2F**

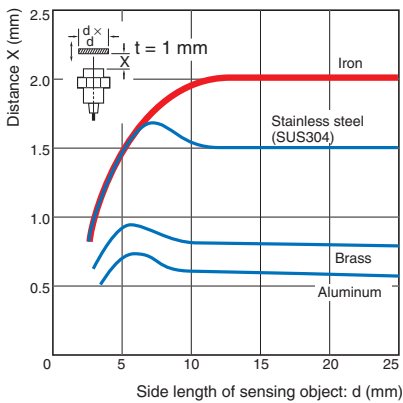

**E2E-X5E/-X5Y/-X5F**

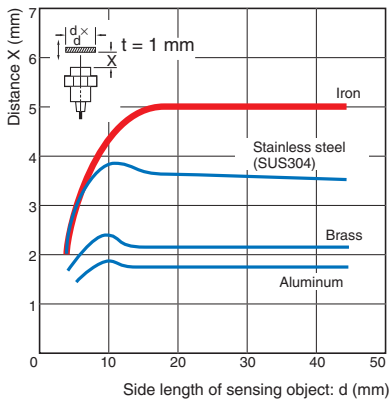

**E2E-X10E/-X10Y/-X10F**

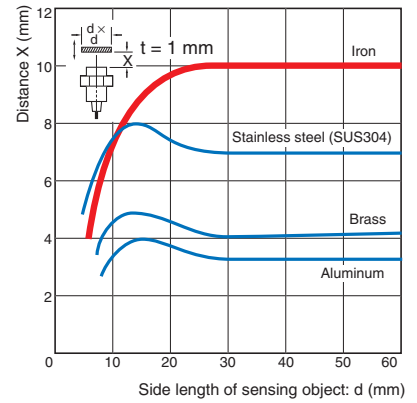

**E2E-X2ME/-X2MY/-X2MF**

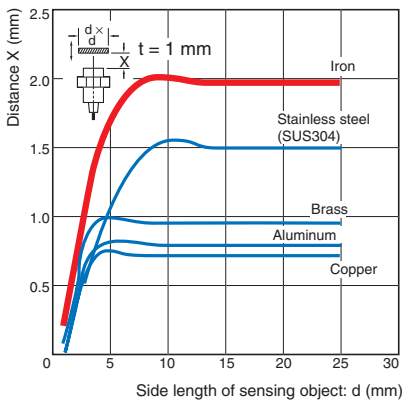

**E2E-X5ME/-X5MY/-X5MF**

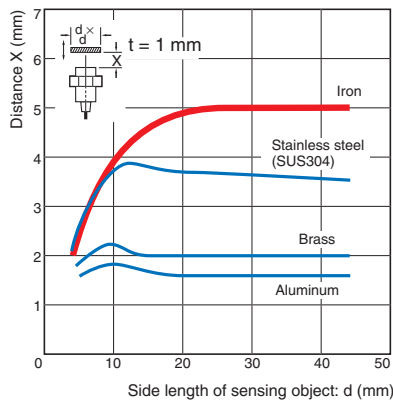

**E2E-X10ME/-X10MY/-X10MF**

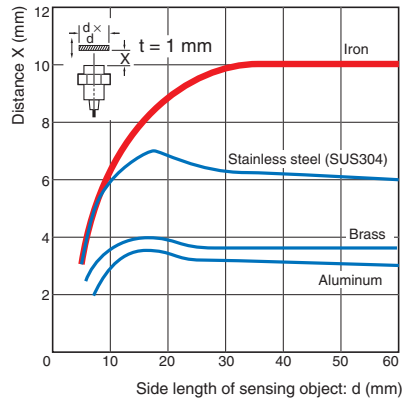

**E2E-X18ME/-X18MY/-X18MF**

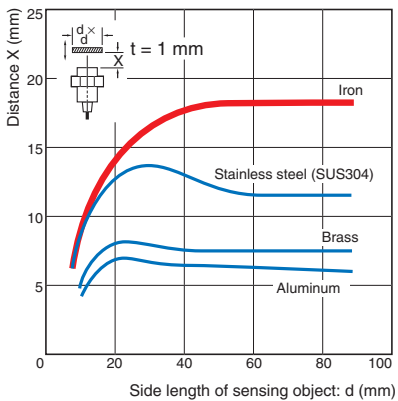

Leakage Current

E2E-X□D□

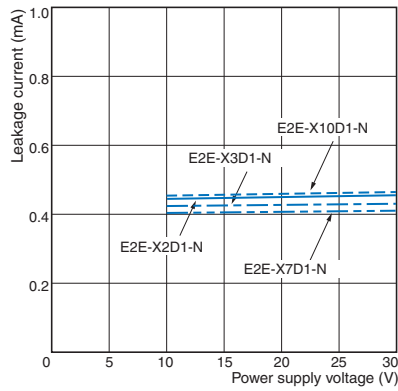

E2E-X□Y□

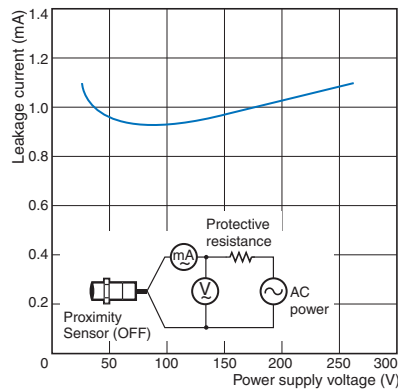

E2E-X□T1

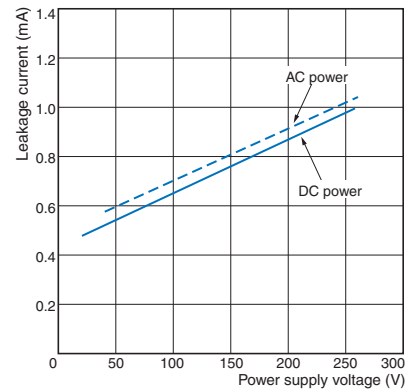

Residual Output Voltage

E2E-X□D□

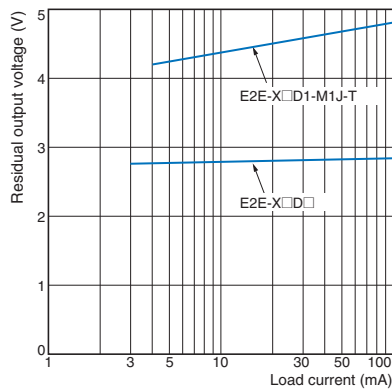

E2E-X□T1

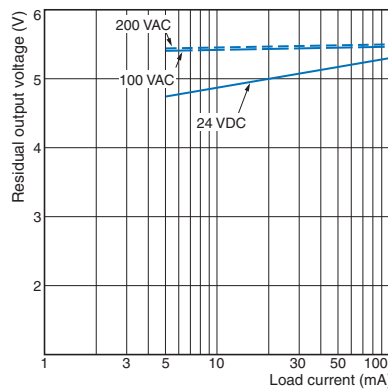

E2E-X□Y□ at 24 VAC

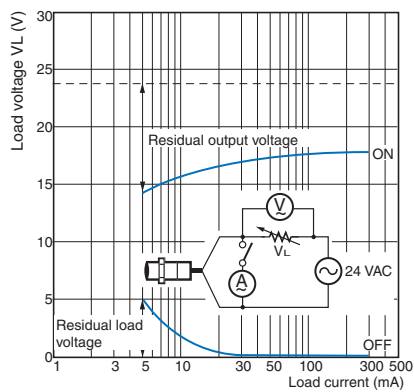

E2E-X□Y□ at 100 VAC

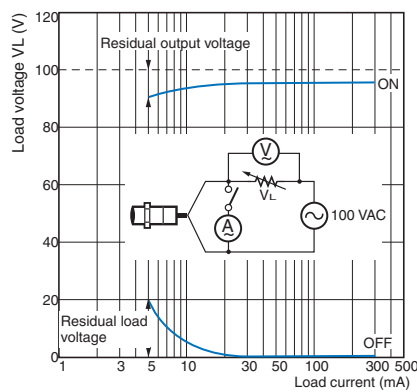

E2E-X□Y□ at 200 VAC

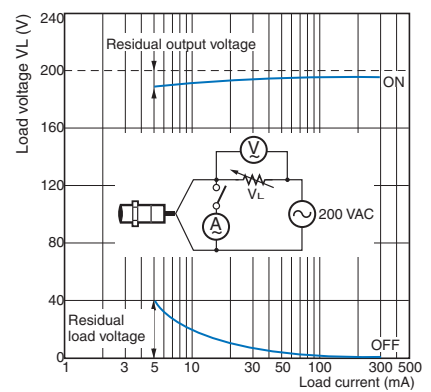

# I/O Circuit Diagrams

## E2E-X□D□ DC 2-Wire Models

Operation mode	Model	Timing Chart	Output circuit
<p><b>Without self-diagnostic output: NO</b></p>	<p>E2E-X□D1-N E2E-X□D1-M1G(J) E2E-X□D1(-M1TGJ)-U E2E-X□D1-M3G E2E-X□D1(-M1TGJ)-US</p>		<p>Polarity: Yes</p> <p>Note: The load can be connected to either the +V or 0 V side.</p>
	<p>E2E-X□D1-M1J-T</p>		<p>Polarity: None</p> <p>Note 1. The load can be connected to either the +V or 0 V side. 2. The E2E-X□D1-M1J-T has no polarity. Therefore, terminals 3 and 4 have no polarity.</p>
<p><b>Without self-diagnostic output: NC</b></p>	<p>E2E-X□D2-N E2E-X□D2-M1G E2E-X□D2(-M1TGJ)-U E2E-X□D2-M3G E2E-X□D2(-M1TGJ)-US</p>		<p>Note: The load can be connected to either the +V or 0 V side.</p>
<p><b>With self-diagnostic output: NO</b></p>	<p>E2E-X□D1S E2E-X□D1S-M1</p>	<p>* The diagnostic output is ON when there is a coil burnout or the sensing object is located in the unstable sensing area for 0.3 s or longer.</p>	<p>Note: Connect both the loads to the +V side of the control output and diagnostic output.</p>

DC 3-Wire Models

Operation mode	Output specifications	Model	Timing Chart	Output circuit
NO	NPN output	E2E-X□E□ E2E-X□E□-M1 E2E-X□E□-M3	Sensing object Present	<p>*Constant current output is 1.5 to 3 mA. Note: For Connector Models, the connection between pins 1, 4 and 3 uses an NO contact, and the connection between pins 1, 2 and 3 uses an NC contact.</p>
			Sensing object Present	
NO	PNP output	E2E-X□F□ E2E-X□F□-M1 E2E-X□F□-M3	Sensing object Present	<p>*When a transistor is connected Note: For Connector Models, the connection between pins 1, 4 and 3 uses an NO contact, and the connection between pins 1, 2 and 3 uses an NC contact.</p>
			Sensing object Present	

AC 2-Wire Models

Operation mode	Model	Timing Chart	Output circuit
NO	E2E-X□Y□ E2E-X□Y□-M1	Sensing object Present	<p>Note: For Connector Models, the connection between pins 3 and 4 uses an NO contact, and the connection between pins 1 and 2 uses an NC contact.</p>
		Sensing object Present	

AC/DC 2-Wire Models

Operation mode	Model	Timing Chart	Output circuit
NO	E2E-X□T1		<p>Note: The load can be connected to either the +V or 0 V side. There is no need to be concerned about the polarity (brown/blue) of the Proximity Sensor.</p>

## Sensor I/O Connectors (Sockets on One Cable End)

Model for Connectors and Pre-wired Connectors: A Connector is not provided with the Sensor. Be sure to order a Connector separately.  
 [Refer to Dimensions for the XS2, XS3, and XS5.]

Applicable connector code	Connector				Applicable Proximity Sensor model number	Connection diagram No. *2
	Screw	Appearance *1	Cable length 2m	Cable length 5m		
			CablConnector model number	CablConnector model number		
A		Straight	XS2F-D421-DA0-F	XS2F-D421-GA0-F	E2E-X□D1-M1G(J)	1
		L-shape	XS2F-D422-DA0-F	XS2F-D422-GA0-F		
B		Straight	XS2F-D421-DC0-F	XS2F-D421-GC0-F	E2E-X□E1-M1	10
		L-shape	XS2F-D422-DC0-F	XS2F-D422-GC0-F	E2E-X□F1-M1	
C		Straight	XS2F-D421-DD0	XS2F-D421-GD0	E2E-X□D1-M1J-T	3
		L-shape	XS2F-D422-DD0	XS2F-D422-GD0	E2E-X□D1-M1	2
D	M12	Straight	XS2F-D421-D80-F	XS2F-D421-G80-F	E2E-X□D2-M1G(J)	6
					E2E-X□D2-M1J-T	8
					E2E-X□D2-M1	7
					E2E-X□D1S-M1	5
					E2E-X□E2-M1 E2E-X□F2-M1	11
		L-shape	XS2F-D422-D80-F	XS2F-D422-G80-F	E2E-X□D2-M1G(J)	6
					E2E-X□D2-M1J-T	8
					E2E-X□D2-M1	7
					E2E-X□D1S-M1	5
					E2E-X□E2-M1 E2E-X□F2-M1	11
E		Straight	XS2F-A421-DB0-F	XS2F-A421-GB0-F	E2E-X□Y1-M1	14
		L-shape	XS2F-A422-DB0-F	XS2F-A422-GB0-F		
F		Straight	XS2F-A421-D90-F	XS2F-A421-G90-F	E2E-X□Y2-M1	15
G		Smartclick Connector, Straight	XS5F-D421-D80-F	XS5F-D421-G80-F	E2E-X□D1-M1TGJ(-US)	16
					E2E-X□D2-M1TGJ-US	17
H		Smartclick Connector, Straight Oil-resistant Reinforced Cables	XS5F-D421-D80-P	XS5F-D421-G80-P	E2E-X□D1-M1TGJ-U	18
					E2E-X□D2-M1TGJ-U	19
I	M8	Straight	XS3F-M421-402-A	XS3F-M421-405-A	E2E-X□D1-M3G	4
					E2E-X□D2-M3G	9
					E2E-X□E1-M3 E2E-X□F1-M3	12
					E2E-X□E2-M3 E2E-X□F2-M3	13
		L-shape	XS3F-M422-402-A	XS3F-M422-405-A	E2E-X□D1-M3G	4
					E2E-X□D2-M3G	9
					E2E-X□E1-M3 E2E-X□F1-M3	12
					E2E-X□E2-M3 E2E-X□F2-M3	13

Note: Refer to Introduction to Sensor I/O Connectors/Sensor Controllers for details and for information on Cable length and Robotics Cables.

\*1. Images of straight and L-shaped connectors.

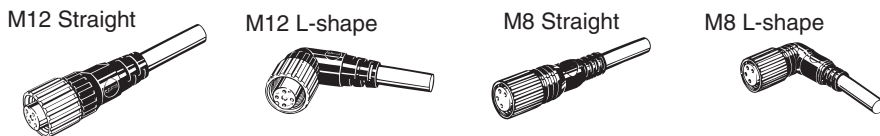

\*2. Refer to Connection Diagrams on page 23 for information on Proximity Sensor and I/O Connector connections.

## Connections for Sensor I/O Connectors

Connection diagram No.	Proximity Sensor			Sensor I/O Connector model number	Connections
	Type	Operation mode	Model		
1	DC 2-wire (IEC pin wiring)	NO	E2E-X□D1-M1G/M1GJ	XS2F-D42□□A0-F 1: Straight 2: L-shape D: 2-m cable G: 5-m cable	
2	DC 2-wire (previous pin wiring)		E2E-X□D1-M1	XS2F-D42□□D0 1: Straight 2: L-shape D: 2-m cable G: 5-m cable	
3	DC 2-wire (no polarity)		E2E-X□D1-M1J-T	XS2F-D42□□D0 1: Straight 2: L-shape D: 2-m cable G: 5-m cable	
4	DC 2-wire (M8 connector)		E2E-X□D1-M3G	XS3F-M42□□40□-A 1: Straight 2: L-shape 2: 2-m cable 5: 5-m cable	
5	DC 2-wire (diagnostic type)		E2E-X□D1S-M1	XS2F-D42□□80-F 1: Straight 2: L-shape D: 2-m cable G: 5-m cable	
6	DC 2-wire (IEC pin wiring)		E2E-X□D2-M1G/M1GJ	XS2F-D42□□80-F 1: Straight 2: L-shape D: 2-m cable G: 5-m cable	
7	DC 2-wire (previous pin wiring)		E2E-X□D2-M1	XS2F-D42□□80-F 1: Straight 2: L-shape D: 2-m cable G: 5-m cable	
8	DC 2-wire (no polarity)		E2E-X□D2-M1J-T	XS2F-D42□□80-F 1: Straight 2: L-shape D: 2-m cable G: 5-m cable	
9	DC 2-wire (M8 connector)		E2E-X□D2-M3G	XS3F-M42□□40□-A 1: Straight 2: L-shape 2: 2-m cable 5: 5-m cable	
		NC			

\* Different from Proximity Sensor wire colors.



Connection diagram No.	Proximity Sensor			Sensor I/O Connector model number	Connections
	Type	Operation mode	Model		
10	DC 3-wire	NO	E2E-X□E/F1-M1	XS2F-D42□-□C0-F 1: Straight 2: L-shape D: 2-m cable G: 5-m cable	
11		NC	E2E-X□E2/F2-M1	XS2F-D42□-□80-F 1: Straight 2: L-shape D: 2-m cable G: 5-m cable	
12	DC 3-wire (M8 connector)	NO	E2E-X□E1/F1-M3	XS3F-M42□-□40□-A 1: Straight 2: L-shape 2: 2-m cable 5: 5-m cable	
13		NC	E2E-X□E2/F2-M3	XS3F-M42□-□40□-A 1: Straight 2: L-shape 2: 2-m cable 5: 5-m cable	
14	AC 2-wire	NO	E2E-X□Y1-M1	XS2F-A42□-□B0-F 1: Straight 2: L-shape D: 2-m cable G: 5-m cable	
15		NC	E2E-X□Y2-M1	XS2F-A421□-□90-F D: 2-m cable G: 5-m cable	
16	DC 2-wire (Smartclick connector)	NO	E2E-X□D1-M1TGJ(-US)	XS5F-D421□-□80-F D: 2-m cable G: 5-m cable	
17		NC	E2E-X□D2-M1TGJ-US	XS5F-D421□-□80-F D: 2-m cable G: 5-m cable	
18		NO	E2E-X□D1-M1TGJ-U	XS5F-D421□-□80-P D: 2-m cable G: 5-m cable	
19		NC	E2E-X□D2-M1TGJ-U	XS5F-D421□-□80-P D: 2-m cable G: 5-m cable	

\* Different from Proximity Sensor wire colors.

**Refer to Introduction to Sensor I/O Connectors/Sensor Controllers for details.**

## Safety Precautions

Refer to *Warranty and Limitations of Liability*.

**⚠ WARNING**

This product is not designed or rated for ensuring safety of persons either directly or indirectly. Do not use it for such purposes.



**CAUTION**

- Do not short the load. Explosion or burning may result.
- Do not supply power to the Sensor with no load, otherwise Sensor may be damaged.

**Precautions for Correct Use**

Do not use this product under ambient conditions that exceed the ratings.

● **Design**

**Influence of Surrounding Metal**

When mounting the Sensor within a metal panel, ensure that the clearances given in the following table are maintained. Failure to maintain these distances may cause deterioration in the performance of the Sensor.

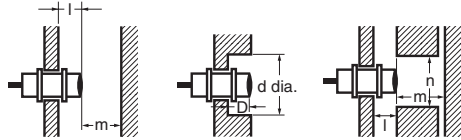

**Influence of Surrounding Metal**

(Unit: mm)

Model	Item	M8	M12	M18	M30	
DC 2-Wire Models E2E-X□D□	Shielded	0				
	d	8	12	18	30	
	D	0				
	m	4.5	8	20	40	
	n	12	18	27	45	
AC/DC 2-Wire Models E2E-X□T1	Unshielded	l	12	15	22	30
		d	24	40	70	90
		D	12	15	22	30
		m	8	20	40	70
		n	24	40	70	90
DC 3-Wire Models E2E-X□E□ E2E-X□F□	Shielded	0				
	d	8	12	18	30	
	D	0				
	m	4.5	8	20	40	
	n	12	18	27	45	
AC 2-Wire Models E2E-X□Y□	Unshielded	l	6	15	22	30
		d	24	40	55	90
		D	6	15	22	30
		m	8	20	40	70
		n	24	36	54	90

**Relationship between Sizes and Models**

Model	Model		
M8	Shielded	E2E-X2D□	
		E2E-X1R5E□	
		E2E-X1R5F□ E2E-X1R5Y□	
	Unshielded	E2E-X4MD□	
		E2E-X2ME□ E2E-X2MF□ E2E-X2MY□	
		M12	Shielded
E2E-X2E□ E2E-X2F□ E2E-X2Y□ E2E-X3T1			
Unshielded	E2E-X8MD□		
	E2E-X5ME□ E2E-X5MF□ E2E-X5MY□		
	M18		Shielded
E2E-X5E□ E2E-X5F□ E2E-X5Y□ E2E-X7T1			
Unshielded		E2E-X14MD□	
		E2E-X10ME□ E2E-X10MF□ E2E-X10MY□	
		M30	Shielded
E2E-X10E□ E2E-X10F□ E2E-X10Y□ E2E-X10T1			
Unshielded	E2E-X20MD□		
	E2E-X18ME□ E2E-X18MF□ E2E-X18MY□		