



Chipsmall Limited consists of a professional team with an average of over 10 year of expertise in the distribution of electronic components. Based in Hongkong, we have already established firm and mutual-benefit business relationships with customers from,Europe,America and south Asia,supplying obsolete and hard-to-find components to meet their specific needs.

With the principle of “Quality Parts,Customers Priority,Honest Operation,and Considerate Service”,our business mainly focus on the distribution of electronic components. Line cards we deal with include Microchip,ALPS,ROHM,Xilinx,Pulse,ON,Everlight and Freescale. Main products comprise IC,Modules,Potentiometer,IC Socket,Relay,Connector.Our parts cover such applications as commercial,industrial, and automotives areas.

We are looking forward to setting up business relationship with you and hope to provide you with the best service and solution. Let us make a better world for our industry!



Contact us

Tel: +86-755-8981 8866 Fax: +86-755-8427 6832

Email & Skype: info@chipsmall.com Web: www.chipsmall.com

Address: A1208, Overseas Decoration Building, #122 Zhenhua RD., Futian, Shenzhen, China



Proximity Sensor with a Long Screw Length



- Increased tightening strength. Cable protectors provided as a standard feature.
- Increased indicator visibility. A milled section for wrench grip on all models.



Be sure to read *Safety Precautions* on page 9.

Ordering Information

Sensors

DC 2-Wire Models

| Appearance | | Sensing distance | | Model | |
|----------------|-----|------------------|--|------------------|----------------|
| | | | | Operation mode | |
| | | | | NO | NC |
| Shielded | M12 | 3 mm | | E2E2-X3D1 2M * | E2E2-X3D2 2M |
| | M18 | 7 mm | | E2E2-X7D1 2M * | E2E2-X7D2 2M |
| | M30 | 10 mm | | E2E2-X10D1 2M * | E2E2-X10D2 2M |
| Unshielded | M12 | 8 mm | | E2E2-X8MD1 2M * | E2E2-X8MD2 2M |
| | M18 | 14 mm | | E2E2-X14MD1 2M * | E2E2-X14MD2 2M |
| | M30 | 20 mm | | E2E2-X20MD1 2M * | E2E2-X20MD2 2M |

*Models with different frequencies are also available. The model numbers are E2E2-X□D15 (example: E2E2-X3D15).

DC 3-Wire Models

| Appearance | | Sensing distance | | Model | |
|----------------|-----|------------------|--|----------------|----------------|
| | | | | Operation mode | |
| | | | | NO | NC |
| Shielded | M12 | 2 mm | | E2E2-X2C1 2M | E2E2-X2C2 2M |
| | M18 | 5 mm | | E2E2-X5C1 2M | E2E2-X5C2 2M |
| | M30 | 10 mm | | E2E2-X10C1 2M | E2E2-X10C2 2M |
| Unshielded | M12 | 5 mm | | E2E2-X5MC1 2M | E2E2-X5MC2 2M |
| | M18 | 10 mm | | E2E2-X10MC1 2M | E2E2-X10MC2 2M |
| | M30 | 18 mm | | E2E2-X18MC1 2M | E2E2-X18MC2 2M |

AC 2-Wire Models

| Appearance | | Sensing distance | | Model | |
|----------------|-----|------------------|--|----------------|----------------|
| | | | | Operation mode | |
| | | | | NO | NC |
| Shielded | M12 | 2 mm | | E2E2-X2Y1 2M | E2E2-X2Y2 2M |
| | M18 | 5 mm | | E2E2-X5Y1 2M | E2E2-X5Y2 2M |
| | M30 | 10 mm | | E2E2-X10Y1 2M | E2E2-X10Y2 2M |
| Unshielded | M12 | 5 mm | | E2E2-X5MY1 2M | E2E2-X5MY2 2M |
| | M18 | 10 mm | | E2E2-X10MY1 2M | E2E2-X10MY2 2M |
| | M30 | 18 mm | | E2E2-X18MY1 2M | E2E2-X18MY2 2M |

Accessories (Order Separately)

Mounting Brackets

Protective Covers

Sputter Protective Covers

Ratings and Specifications

E2E2-X□D□ DC 2-Wire Models

| Item | Size Shielding Model | M12 | | M18 | | M30 | |
|---|-------------------------------|---|-------------------------|-------------------------|-------------------------|-------------------------|-------------------------|
| | | Shielded | Unshielded | Shielded | Unshielded | Shielded | Unshielded |
| | | E2E2-X3D□ | E2E2-X8MD□ | E2E2-X7D□ | E2E2-X14MD□ | E2E2-X10D□ | E2E2-X20MD□ |
| Sensing distance | | 3 mm±10% | 8 mm±10% | 7 mm±10% | 14 mm±10% | 10 mm±10% | 20 mm±10% |
| Set distance *1 | | 0 to 2.4 mm | 0 to 6.4 mm | 0 to 5.6 mm | 0 to 11.2 mm | 0 to 8 mm | 0 to 16 mm |
| Differential travel | | 10% max. of sensing distance | | | | | |
| Sensing object | | Ferrous metal (The sensing distance decreases with non-ferrous metal. Refer to <i>Engineering Data</i> on page 5.) | | | | | |
| Standard sensing object | | Iron, 12 × 12 × 1 mm | Iron, 30 × 30 × 1 mm | Iron, 18 × 18 × 1 mm | Iron, 30 × 30 × 1 mm | Iron, 30 × 30 × 1 mm | Iron, 54 × 54 × 1 mm |
| Response frequency *2 | | 1 kHz | 800 Hz | 500 Hz | 400 Hz | | 100 Hz |
| Power supply voltage (operating voltage range) | | 12 to 24 VDC (10 to 30 VDC), ripple (p-p): 10% max. | | | | | |
| Leakage current | | 0.8 mA max. | | | | | |
| Control output | Switching capacity | 3 to 100 mA | | | | | |
| | Residual voltage | 3 V max. (Load current: 100 mA, Cable length: 2 m) | | | | | |
| Indicators | | D1 Models: Operation indicator (red) and setting indicator (green) D2 Models: Operation indicator (red) | | | | | |
| Operation mode (with sensing object ap- proaching) | | D1 Models: NO Refer to the timing charts under <i>I/O Circuit Diagrams</i> on page 8 for details. D2 Models: NC | | | | | |
| Protection circuits | | Surge absorber, Load short-circuit protection | | | | | |
| Ambient temperature | | Operating/Storage: -25 to 70°C (with no icing or condensation) | | | | | |
| Ambient humidity | | Operating/Storage: 35% to 95% (with no condensation) | | | | | |
| Temperature influence | | ±10% max. of sensing distance at 23°C in the temperature range of -25 to 70°C | | | | | |
| Voltage influence | | ±1% max. of sensing distance at rated voltage in the rated voltage ±15% range | | | | | |
| Insulation resistance | | 50 MΩ min. (at 500 VDC) between current-carrying parts and case | | | | | |
| Dielectric strength | | 1000 VAC, 50/60 Hz for 1 minute between current-carrying parts and case | | | | | |
| Vibration resistance (destruction) | | 10 to 55 Hz, 1.5-mm double amplitude for 2 hours each in X, Y, and Z directions | | | | | |
| Shock resistance (destruction) | | 1,000 m/s ² 10 times each in X, Y, and Z directions | | | | | |
| Degree of protection | | IEC IP67, in-house standard for oil resistance | | | | | |
| Connection method | | Pre-wired Models (Standard cable length: 2 m) | | | | | |
| Weight (packed state) | | Approx. 65 g | | Approx. 150 g | | Approx. 210 g | |
| Material- als | Case | Brass | | | | | |
| | Sensing surface | PBT | | | | | |
| | Clamping nuts | Nickel-plated brass | | | | | |
| | Toothed washer | Zinc-plated iron | | | | | |
| Accessories | | Instruction sheet | | | | | |

*1. Use the E2E2 within the range in which the setting indicator (green LED) is ON (except D2 Models).

*2. The response frequency is an average value. Measurement conditions are as follows: standard sensing object, a distance of twice the standard sensing object, and a set distance of half the sensing distance.

E2E2-X□□ DC 3-Wire Models

| Item | Size Shielding Model | M12 | | M18 | | M30 | |
|---|----------------------------|--|-------------------------|-------------------------|-------------------------|-------------------------|-------------------------|
| | | Shielded | Unshielded | Shielded | Unshielded | Shielded | Unshielded |
| | | E2E2-X2C□ | E2E2-X5MC□ | E2E2-X5C□ | E2E2-X10MC□ | E2E2-X10C□ | E2E2-X18MC□ |
| Sensing distance | | 2 mm±10% | 5 mm±10% | 5 mm±10% | 10 mm±10% | 10 mm±10% | 18 mm±10% |
| Set distance | | 0 to 1.6 mm | 0 to 4 mm | 0 to 4 mm | 0 to 8 mm | 0 to 8 mm | 0 to 14 mm |
| Differential travel | | 10% max. of sensing distance | | | | | |
| Sensing object | | Ferrous metal (The sensing distance decreases with non-ferrous metal. Refer to <i>Engineering Data</i> on page 5.) | | | | | |
| Standard sensing object | | Iron, 12 × 12 × 1 mm | Iron, 15 × 15 × 1 mm | Iron, 18 × 18 × 1 mm | Iron, 30 × 30 × 1 mm | Iron, 30 × 30 × 1 mm | Iron, 54 × 54 × 1 mm |
| Response frequency *1 | | 1.5 kHz | 400 Hz | 600 Hz | 200 Hz | 400 Hz | 100 Hz |
| Power supply voltage (operating voltage range) *2 | | 12 to 24 VDC (10 to 30 VDC), ripple (p-p): 10% max. | | | | | |
| Leakage current | | 13 mA max. | | | | | |
| Control output | Load current | NPN open-collector output, 200 mA max. (30 VDC max.) | | | | | |
| | Residual voltage | 2 V max. (Load current: 200 mA, Cable length: 2 m) | | | | | |
| Indicators | | Operation indicator (red) | | | | | |
| Operation mode (with sensing object approaching) | | C1 Models: NO Refer to the timing charts under <i>I/O Circuit Diagrams</i> on page 8 for details. C2 Models: NC | | | | | |
| Protection circuits | | Reverse polarity protection, Surge absorber, Load short-circuit protection | | | | | |
| Ambient temperature | | Operating/Storage: -40 to 85°C (with no icing or condensation) | | | | | |
| Ambient humidity | | Operating/Storage: 35% to 95% (with no condensation) | | | | | |
| Temperature influence | | ±15% max. of sensing distance at 23°C in the temperature range of -40 to 85°C ±10% max. of sensing distance at 23°C in the temperature range of -25 to 70°C | | | | | |
| Voltage influence | | ±1% max. of sensing distance at rated voltage in the rated voltage ±15% range | | | | | |
| Insulation resistance | | 50 MΩ min. (at 500 VDC) between current-carrying parts and case | | | | | |
| Dielectric strength | | 1,000 VAC, 50/60 Hz for 1 minute between current carry parts and case | | | | | |
| Vibration resistance (destruction) | | 10 to 55 Hz, 1.5-mm double amplitude for 2 hours each in X, Y, and Z directions | | | | | |
| Shock resistance (destruction) | | 1,000 m/s ² 10 times each in X, Y, and Z directions | | | | | |
| Degree of protection | | IEC IP67, in-house standard for oil resistance | | | | | |
| Connection method | | Pre-wired Models (Standard cable length: 2 m) and Connector Models | | | | | |
| Weight (packed state) | | Approx. 75 g | | Approx. 160 g | | Approx. 220 g | |
| Materials | Case | Brass | | | | | |
| | Sensing surface | PBT | | | | | |
| | Clamping nuts | Nickel-plated brass | | | | | |
| | Toothed washer | Zinc-plated iron | | | | | |
| Accessories | | Instruction sheet | | | | | |

*1. The response frequency is an average value. Measurement conditions are as follows: standard sensing object, a distance of twice the standard sensing object, and a set distance of half the sensing distance.

*2. A full-wave rectification power supply of 24 VDC ±20% (average value) can be used.

E2E2-X□Y□ AC 2-Wire Models

| Item | Size Shielding Model | M12 | | M18 | | M30 | |
|---|----------------------------|---|-------------------------|-------------------------|-------------------------|-------------------------|-------------------------|
| | | Shielded | Unshielded | Shielded | Unshielded | Shielded | Unshielded |
| | | E2E2-X2Y□ | E2E2-X5MY□ | E2E2-X5Y□ | E2E2-X10MY□ | E2E2-X10Y□ | E2E2-X18MY□ |
| Sensing distance | | 2 mm±10% | 5 mm±10% | 5 mm±10% | 10 mm±10% | 10 mm±10% | 18 mm±10% |
| Set distance | | 0 to 1.6 mm | 0 to 4 mm | 0 to 4 mm | 0 to 8 mm | 0 to 8 mm | 0 to 14 mm |
| Differential travel | | 10% max. of sensing distance | | | | | |
| Sensing object | | Ferrous metal (The sensing distance decreases with non-ferrous metal. Refer to <i>Engineering Data</i> on page 5.) | | | | | |
| Standard sensing object | | Iron, 12 × 12 × 1 mm | Iron, 15 × 15 × 1 mm | Iron, 18 × 18 × 1 mm | Iron, 30 × 30 × 1 mm | Iron, 30 × 30 × 1 mm | Iron, 54 × 54 × 1 mm |
| Response frequency | | 25 Hz | | | | | |
| Power supply voltage (operating voltage range) *1 | | 24 to 240 VAC (20 to 264 VAC), 50/60 Hz | | | | | |
| Leakage current | | 1.7 mA max. | | | | | |
| Control output | Load current *2 | 5 to 200 mA | | 5 to 300 mA | | | |
| | Residual voltage | Refer to <i>Engineering Data</i> on page 5. | | | | | |
| Indicators | | Operation indicator (red) | | | | | |
| Operation mode (with sensing object approaching) | | Y1 Models: NO Refer to the timing charts under <i>I/O Circuit Diagrams</i> on page 8 for details. Y2 Models: NC | | | | | |
| Ambient temperature *1, 2 | | Operating/Storage: -40 to 85°C (with no icing or condensation) | | | | | |
| Ambient humidity | | Operating/Storage: 35% to 95% (with no condensation) | | | | | |
| Temperature influence | | ±15% max. of sensing distance at 23°C in the temperature range of -40 to 85°C, ±10% max. of sensing distance at 23°C in the temperature range of -25 to 70°C | | | | | |
| Voltage influence | | ±1% max. of sensing distance at rated voltage in the rated voltage ±15% range | | | | | |
| Insulation resistance | | 50 MΩ min. (at 500 VDC) between current-carrying parts and case | | | | | |
| Dielectric strength | | 4,000 VAC, 50/60 Hz for 1 minute between current carry parts and case | | | | | |
| Vibration resistance (destruction) | | 10 to 55 Hz, 1.5-mm double amplitude for 2 hours each in X, Y, and Z directions | | | | | |
| Shock resistance (destruction) | | 1,000 m/s ² 10 times each in X, Y, and Z directions | | | | | |
| Degree of protection | | IEC IP67, in-house standard for oil resistance | | | | | |
| Connection method | | Pre-wired Models (Standard cable length: 2 m) and Connector Models | | | | | |
| Weight (packed state) | | Approx. 65 g | | Approx. 150 g | | Approx. 210 g | |
| Materials | Case | Brass | | | | | |
| | Sensing surface | PBT | | | | | |
| | Clamping nuts | Nickel-plated brass | | | | | |
| | Toothed washer | Zinc-plated iron | | | | | |
| Accessories | | Instruction sheet | | | | | |

*1. When supplying 24 VAC to any of the above models, make sure that the operating ambient temperature range is at least -25°C to 85°C.

*2. When using an M18 or M30 Connector Model at an ambient temperature between 70 and 85°C, make sure that the Sensor has a control output (load current) of 5 to 200 mA max.

Engineering Data (Reference Value)

Sensing Area Shielded Models E2E2-X□D□

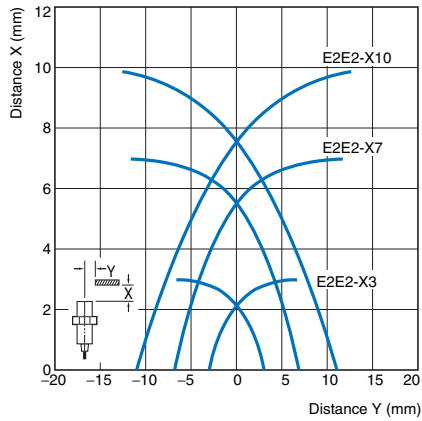

E2E2-X□C□/-X□Y□

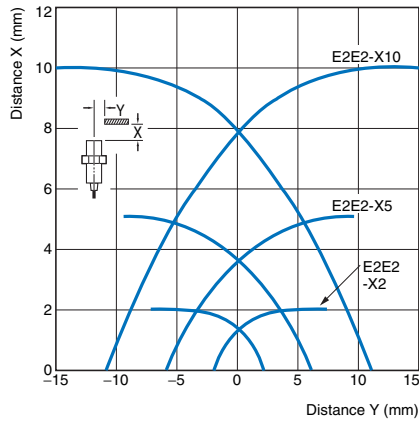

Unshielded Models E2E2-X□MD□

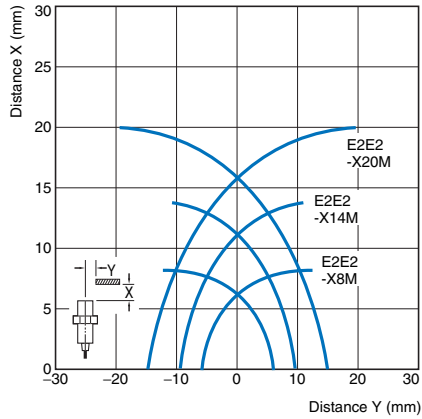

E2E2-X□MC□/-X□MY□

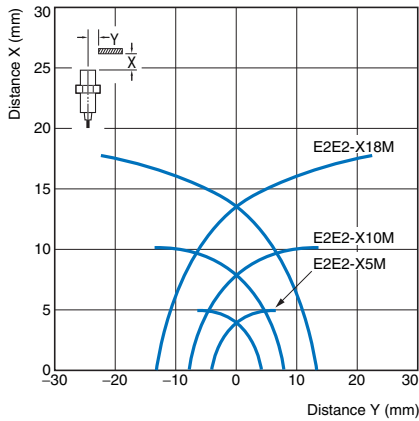

Leakage Current E2E2-X□D□

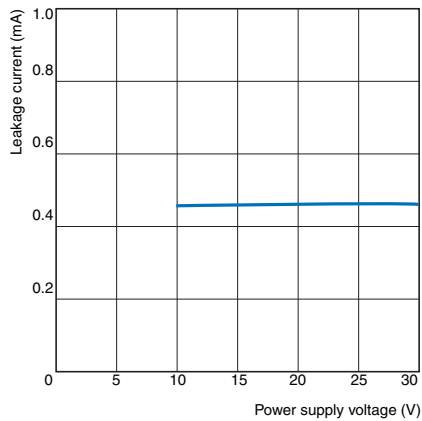

E2E2-X□Y□

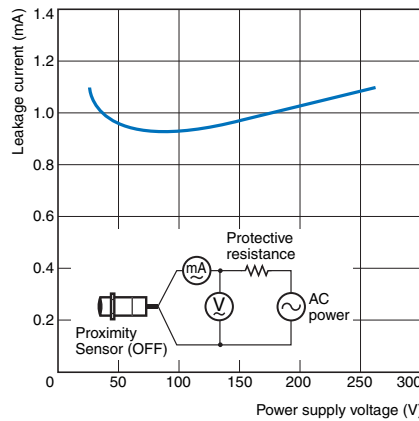

Residual Output Voltage E2E2-X□D□

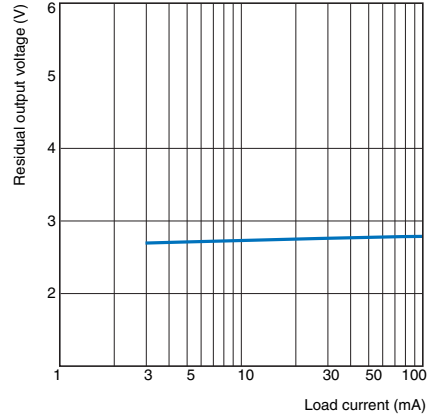

E2E2-X□Y□

at 24 VAC

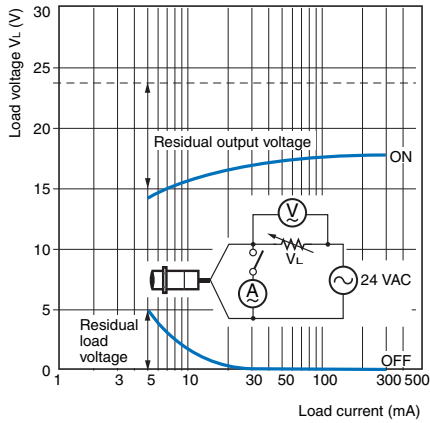

E2E2-X□Y□

at 100 VAC

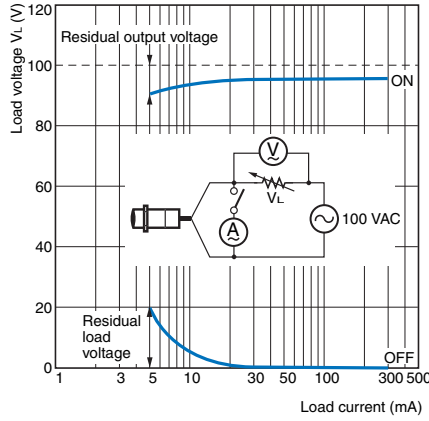

E2E2-X□Y□

at 200 VAC

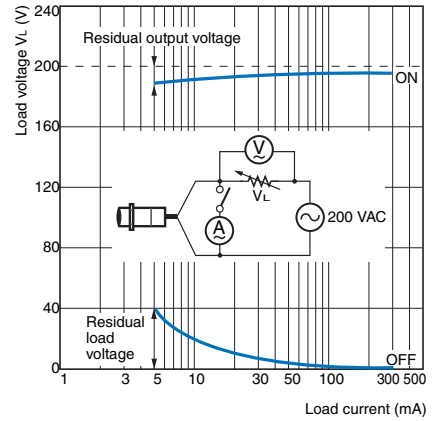

Influence of Sensing Object Size and Material

E2E2-X3D□

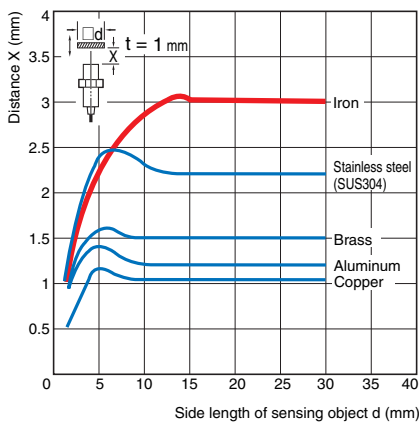

E2E2-X7D□

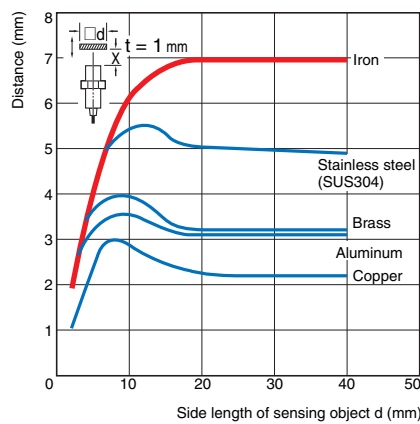

E2E2-X10D□

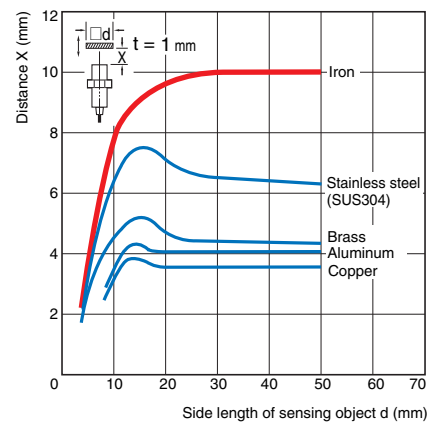

E2E2-X8MD□

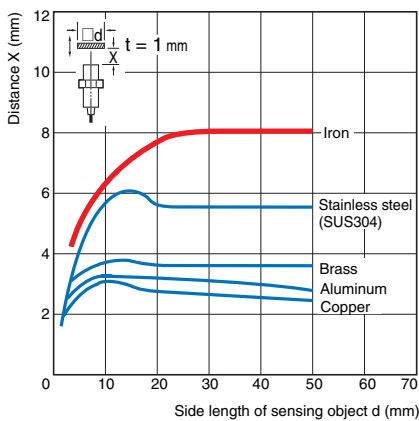

E2E2-X14MD□

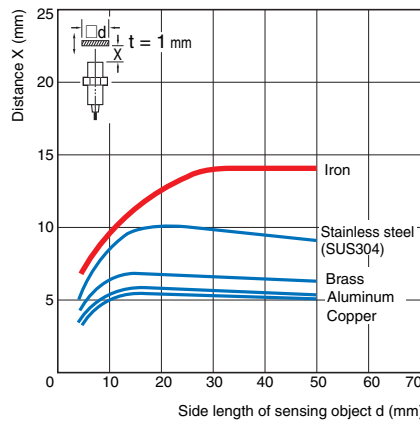

E2E2-X20MD□

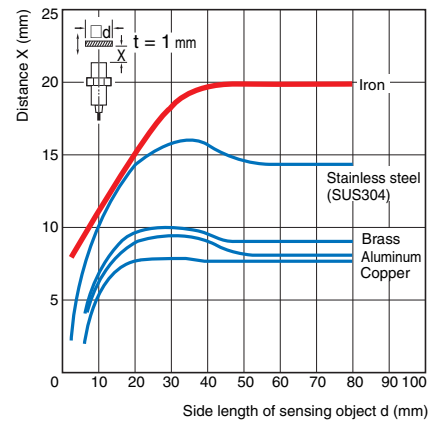

E2E2-X2C□/-X2Y□

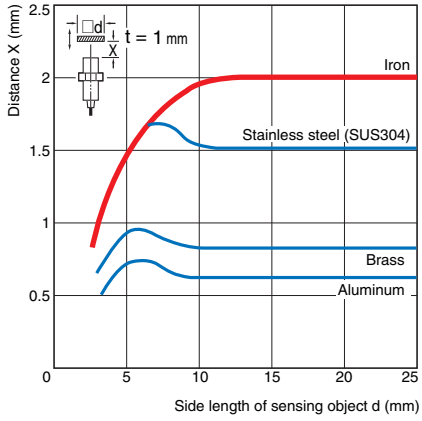

E2E2-X5C□/-X5Y□

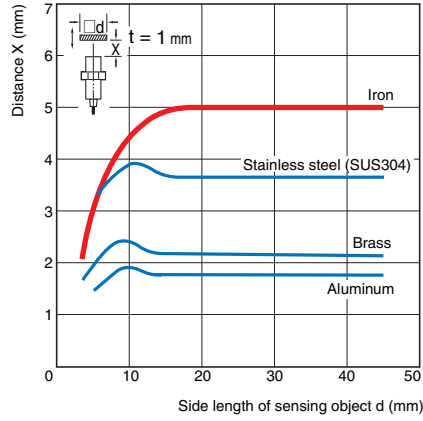

E2E2-X10C□/-X10Y□

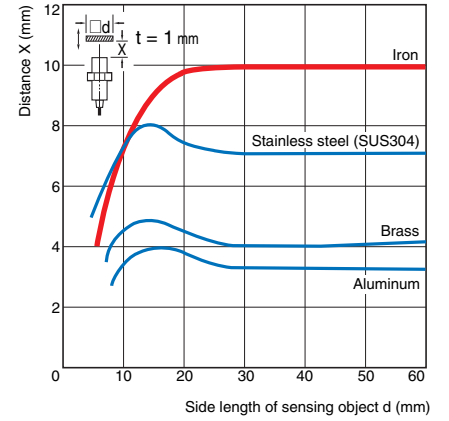

E2E2-X5MC□/-X5MY□

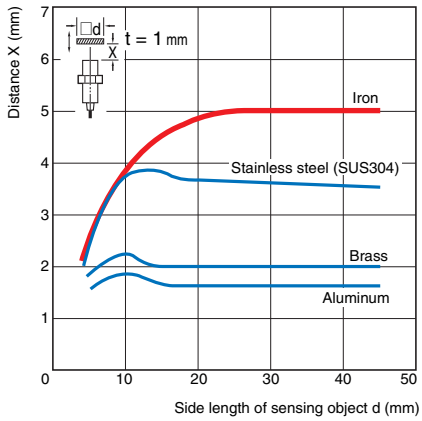

E2E2-X10MC□/-X10MY□

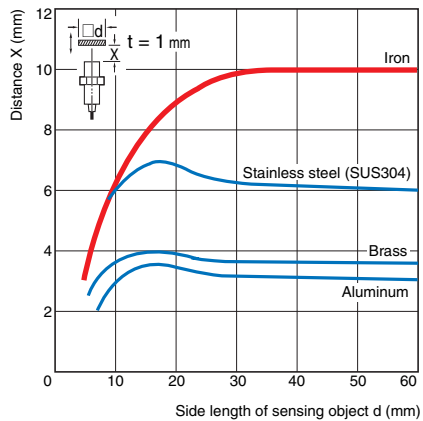

E2E2-X18MC□/-X18MY□

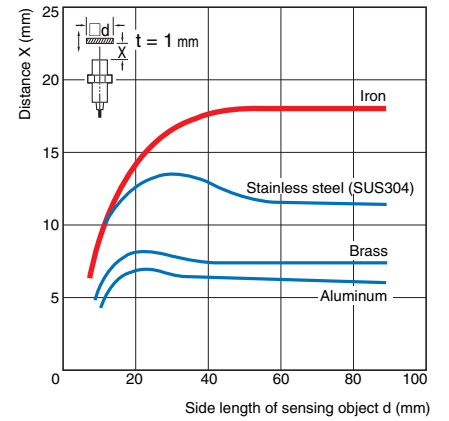

I/O Circuit Diagrams

DC 2-Wire Models

| Operation mode | Model | Timing Charts | Output circuit |
|----------------|--|---------------|--|
| NO | E2E2-X3D1 E2E2-X7D1 E2E2-X10D1 E2E2-X8MD1 E2E2-X14MD1 E2E2-X20MD1 | | <p>Note: The load can be connected to either the +V or 0 V side.</p> |
| NC | E2E2-X3D2 E2E2-X7D2 E2E2-X10D2 E2E2-X8MD2 E2E2-X14MD2 E2E2-X20MD2 | | |

DC 3-Wire Models

| Operation mode | Model | Timing Charts | Output circuit |
|----------------|--|---------------|----------------|
| NO | E2E2-X2C1 E2E2-X5C1 E2E2-X10C1 E2E2-X5MC1 E2E2-X10MC1 E2E2-X18MC1 | | |
| NC | E2E2-X2C2 E2E2-X5C2 E2E2-X10C2 E2E2-X5MC2 E2E2-X10MC2 E2E2-X18MC2 | | |

AC 2-Wire Models

| Operation mode | Model | Timing Charts | Output circuit |
|----------------|-------------|---------------|----------------|
| NO | E2E2-X2Y1 | | |
| | E2E2-X5Y1 | | |
| | E2E2-X10Y1 | | |
| | E2E2-X5MY1 | | |
| | E2E2-X10MY1 | | |
| NC | E2E2-X2Y2 | | |
| | E2E2-X5Y2 | | |
| | E2E2-X10Y2 | | |
| | E2E2-X5MY2 | | |
| | E2E2-X10MY2 | | |

Safety Precautions

WARNING

This product is not designed or rated for ensuring safety of persons either directly or indirectly.



Do not use it for such purposes.

Precautions for Correct Use

Do not use this product under ambient conditions that exceed the ratings.

● Design

Influence of Surrounding Metal

When mounting the Sensor within a metal panel, ensure that the clearances given in the following table are maintained.

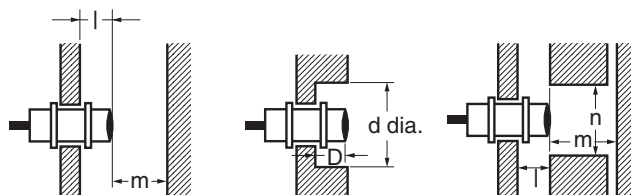

(Unit: mm)

| Model | Item | M12 | M18 | M30 | |
|--|------------|-----|-----|-----|----|
| DC 2-Wire Models E2E2-X□D□ | Shielded | l | 0 | 0 | 0 |
| | | d | 12 | 18 | 30 |
| | | D | 0 | 0 | 0 |
| | | m | 8 | 20 | 40 |
| | | n | 18 | 27 | 45 |
| | Unshielded | l | 15 | 22 | 30 |
| | | d | 40 | 70 | 90 |
| | | D | 15 | 22 | 30 |
| | | m | 20 | 40 | 70 |
| | | n | 40 | 70 | 90 |
| DC 3-Wire Models E2E2-X□C□ AC 2-Wire Models E2E2-X□Y□ | Shielded | l | 0 | 0 | 0 |
| | | d | 12 | 18 | 30 |
| | | D | 0 | 0 | 0 |
| | | m | 8 | 20 | 40 |
| | | n | 18 | 27 | 45 |
| | Unshielded | l | 15 | 22 | 30 |
| | | d | 40 | 55 | 90 |
| | | D | 15 | 22 | 30 |
| | | m | 20 | 40 | 70 |
| | | n | 36 | 54 | 90 |

Mutual Interference

When installing Sensors face-to-face or side-by-side, ensure that the minimum distances given in the following table are maintained.

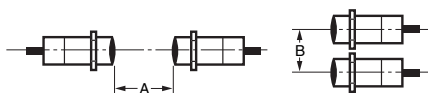

Mutual Interference

(Unit: mm)

| Model | Item | M12 | M18 | M30 | |
|-------------------------------|------------|-----|-------------|--------------|--------------|
| DC 2-Wire Models E2E2-X□D□ | Shielded | A | 30 (20) | 50 (30) | 100 (50) |
| | | B | 20 | 35 (18) | 70 (35) |
| | Unshielded | A | 120 (60) | 200 (100) | 300 (100) |
| | | B | 100 (50) | 110 (60) | 200 (100) |
| DC 3-Wire Models E2E2-X□C□ | Shielded | A | 30 | 50 | 100 |
| | | B | 20 | 35 | 70 |
| AC 2-Wire Models E2E2-X□Y□ | Unshielded | A | 120 | 200 | 300 |
| | | B | 100 | 110 | 200 |

Note: Values in parentheses apply to Sensors operating at different frequencies.

Relationship between Sizes and Models

| Size | Model | | |
|------------|------------|--|---|
| M12 | Shielded | E2E2-X3D□ E2E2-X2C□ E2E2-X2Y□ | |
| | Unshielded | E2E2-X8MD□ E2E2-X5MC□ E2E2-X5MY□ | |
| | | M18 | Shielded |
| Unshielded | | | E2E2-X14MD□ E2E2-X10MC□ E2E2-X10MY□ |
| | M30 | | Shielded |
| | | Unshielded | E2E2-X20MD□ E2E2-X18MC□ E2E2-X18MY□ |

● Mounting



tening Torque

Do not tighten the nut with excessive force.

A washer must be used with the nut.

The following strengths assume washers are being used.

| Model | Torque |
|-------|---------|
| M12 | 30 N·m |
| M18 | 70 N·m |
| M30 | 180 N·m |

Dimensions

Unless otherwise specified, the tolerance class IT16 is used for dimensions in this data sheet.

Shielded

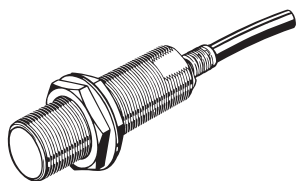

Unshielded

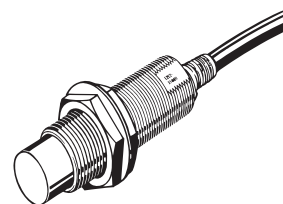

E2E2-X3D□/E2E2-X2C□/E2E2-X2Y□

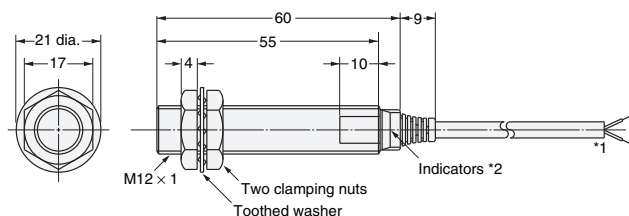

- *1. 4-dia. vinyl-insulated round cable with 2 conductors (Conductor cross section: 0.3 mm², Insulator diameter: 1.3 mm), Standard length: 2 m
- 4-dia. vinyl-insulated round cable with 3 conductors (Conductor cross section: 0.3 mm², Insulator diameter: 1.3 mm), Standard length: 2 m
- The cable can be extended to up to 200 m (Separate metal conduit.)
- *2. D Models: Operation indicator (red) and setting indicator (green), C/Y Models: Operation indicator (red)

E2E2-X8MD□/E2E2-X5MC□/E2E2-X5MY□

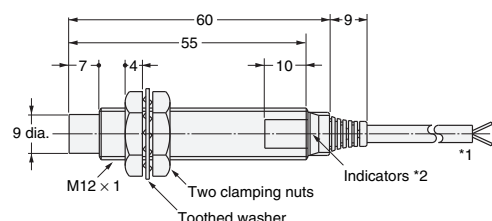

- *1. 4-dia. vinyl-insulated round cable with 2 conductors (Conductor cross section: 0.3 mm², Insulator diameter: 1.3 mm), Standard length: 2 m
- 4-dia. vinyl-insulated round cable with 3 conductors (Conductor cross section: 0.3 mm², Insulator diameter: 1.3 mm), Standard length: 2 m
- The cable can be extended to up to 200 m (Separate metal conduit.)
- *2. D Models: Operation indicator (red) and setting indicator (green), C/Y Models: Operation indicator (red)

E2E2-X7D□/E2E2-X5C□/E2E2-X5Y□

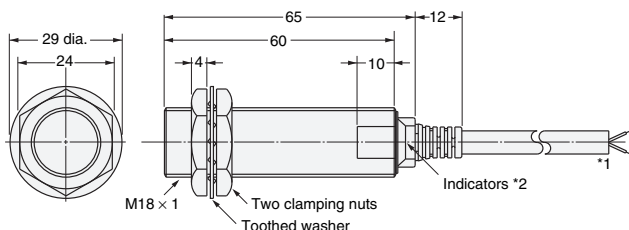

- *1. 6-dia. vinyl-insulated round cable with 2 conductors (Conductor cross section: 0.5 mm², Insulator diameter: 1.9 mm), Standard length: 2 m
- 6-dia. vinyl-insulated round cable with 3 conductors (Conductor cross section: 0.5 mm², Insulator diameter: 1.9 mm), Standard length: 2 m
- The cable can be extended to up to 200 m (Separate metal conduit.)
- *2. D Models: Operation indicator (red) and setting indicator (green), C/Y Models: Operation indicator (red)

E2E2-X14MD□/E2E2-X10MC□/E2E2-X10MY□

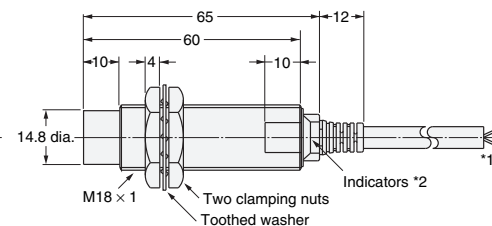

- *1. 6-dia. vinyl-insulated round cable with 2 conductors (Conductor cross section: 0.5 mm², Insulator diameter: 1.9 mm), Standard length: 2 m
- 6-dia. vinyl-insulated round cable with 3 conductors (Conductor cross section: 0.5 mm², Insulator diameter: 1.9 mm), Standard length: 2 m
- The cable can be extended to up to 200 m (Separate metal conduit.)
- *2. D Models: Operation indicator (red) and setting indicator (green), C/Y Models: Operation indicator (red)

E2E2-X10D□/E2E2-X10C□/E2E2-X10Y□

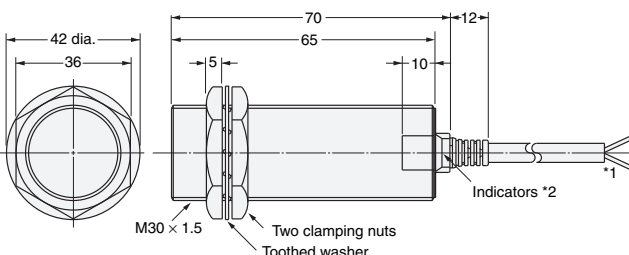

- *1. 6-dia. vinyl-insulated round cable with 2 conductors (Conductor cross section: 0.5 mm², Insulator diameter: 1.9 mm), Standard length: 2 m
- 6-dia. vinyl-insulated round cable with 3 conductors (Conductor cross section: 0.5 mm², Insulator diameter: 1.9 mm), Standard length: 2 m
- The cable can be extended to up to 200 m (Separate metal conduit.)
- *2. D Models: Operation indicator (red) and setting indicator (green), C/Y Models: Operation indicator (red)

E2E2-X20MD□/E2E2-X18MC□/E2E2-X18MY□

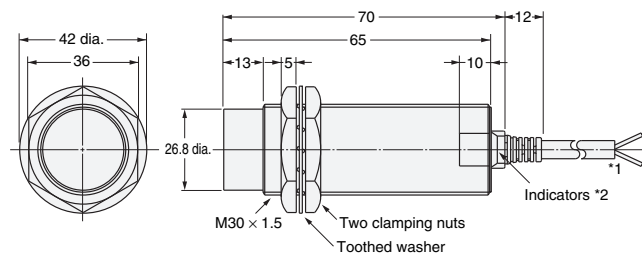

- *1. 6-dia. vinyl-insulated round cable with 2 conductors (Conductor cross section: 0.5 mm², Insulator diameter: 1.9 mm), Standard length: 2 m
- 6-dia. vinyl-insulated round cable with 3 conductors (Conductor cross section: 0.5 mm², Insulator diameter: 1.9 mm), Standard length: 2 m
- The cable can be extended to up to 200 m (Separate metal conduit.)
- *2. D Models: Operation indicator (red) and setting indicator (green), C/Y Models: Operation indicator (red)

Mounting Hole Dimensions

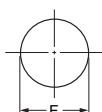

| Dimension | M12 | M18 | M30 |
|-----------|--|--|--|
| F (mm) | 12.5 ^{+0.5} ₀ dia. | 18.5 ^{+0.5} ₀ dia. | 30.5 ^{+0.5} ₀ dia. |

- Note 1. Two clamping nuts and one toothed washer are provided with each Sensors.
- 2. The model number is laser-marked on the cable section and milled section.

In the interest of product improvement, specifications are subject to change without notice.

Terms and Conditions Agreement

Read and understand this catalog.

Please read and understand this catalog before purchasing the products. Please consult your OMRON representative if you have any questions or comments.

Warranties.

(a) Exclusive Warranty. Omron's exclusive warranty is that the Products will be free from defects in materials and workmanship for a period of twelve months from the date of sale by Omron (or such other period expressed in writing by Omron). Omron disclaims all other warranties, express or implied.

(b) Limitations. OMRON MAKES NO WARRANTY OR REPRESENTATION, EXPRESS OR IMPLIED, ABOUT NON-INFRINGEMENT, MERCHANTABILITY OR FITNESS FOR A PARTICULAR PURPOSE OF THE PRODUCTS. BUYER ACKNOWLEDGES THAT IT ALONE HAS DETERMINED THAT THE PRODUCTS WILL SUITABLY MEET THE REQUIREMENTS OF THEIR INTENDED USE.

Omron further disclaims all warranties and responsibility of any type for claims or expenses based on infringement by the Products or otherwise of any intellectual property right. (c) Buyer Remedy. Omron's sole obligation hereunder shall be, at Omron's election, to (i) replace (in the form originally shipped with Buyer responsible for labor charges for removal or replacement thereof) the non-complying Product, (ii) repair the non-complying Product, or (iii) repay or credit Buyer an amount equal to the purchase price of the non-complying Product; provided that in no event shall Omron be responsible for warranty, repair, indemnity or any other claims or expenses regarding the Products unless Omron's analysis confirms that the Products were properly handled, stored, installed and maintained and not subject to contamination, abuse, misuse or inappropriate modification. Return of any Products by Buyer must be approved in writing by Omron before shipment. Omron Companies shall not be liable for the suitability or unsuitability or the results from the use of Products in combination with any electrical or electronic components, circuits, system assemblies or any other materials or substances or environments. Any advice, recommendations or information given orally or in writing, are not to be construed as an amendment or addition to the above warranty.

See <http://www.omron.com/global/> or contact your Omron representative for published information.

Limitation on Liability; Etc.

OMRON COMPANIES SHALL NOT BE LIABLE FOR SPECIAL, INDIRECT, INCIDENTAL, OR CONSEQUENTIAL DAMAGES, LOSS OF PROFITS OR PRODUCTION OR COMMERCIAL LOSS IN ANY WAY CONNECTED WITH THE PRODUCTS, WHETHER SUCH CLAIM IS BASED IN CONTRACT, WARRANTY, NEGLIGENCE OR STRICT LIABILITY.

Further, in no event shall liability of Omron Companies exceed the individual price of the Product on which liability is asserted.

Suitability of Use.

Omron Companies shall not be responsible for conformity with any standards, codes or regulations which apply to the combination of the Product in the Buyer's application or use of the Product. At Buyer's request, Omron will provide applicable third party certification documents identifying ratings and limitations of use which apply to the Product. This information by itself is not sufficient for a complete determination of the suitability of the Product in combination with the end product, machine, system, or other application or use. Buyer shall be solely responsible for determining appropriateness of the particular Product with respect to Buyer's application, product or system. Buyer shall take application responsibility in all cases.

NEVER USE THE PRODUCT FOR AN APPLICATION INVOLVING SERIOUS RISK TO LIFE OR PROPERTY OR IN LARGE QUANTITIES WITHOUT ENSURING THAT THE SYSTEM AS A WHOLE HAS BEEN DESIGNED TO ADDRESS THE RISKS, AND THAT THE OMRON PRODUCT(S) IS PROPERLY RATED AND INSTALLED FOR THE INTENDED USE WITHIN THE OVERALL EQUIPMENT OR SYSTEM.

Programmable Products.

Omron Companies shall not be responsible for the user's programming of a programmable Product, or any consequence thereof.

Performance Data.

Data presented in Omron Company websites, catalogs and other materials is provided as a guide for the user in determining suitability and does not constitute a warranty. It may represent the result of Omron's test conditions, and the user must correlate it to actual application requirements. Actual performance is subject to the Omron's Warranty and Limitations of Liability.

Change in Specifications.

Product specifications and accessories may be changed at any time based on improvements and other reasons. It is our practice to change part numbers when published ratings or features are changed, or when significant construction changes are made. However, some specifications of the Product may be changed without any notice. When in doubt, special part numbers may be assigned to fix or establish key specifications for your application. Please consult with your Omron's representative at any time to confirm actual specifications of purchased Product.

Errors and Omissions.

Information presented by Omron Companies has been checked and is believed to be accurate; however, no responsibility is assumed for clerical, typographical or proofreading errors or omissions.