



Chipsmall Limited consists of a professional team with an average of over 10 year of expertise in the distribution of electronic components. Based in Hongkong, we have already established firm and mutual-benefit business relationships with customers from,Europe,America and south Asia,supplying obsolete and hard-to-find components to meet their specific needs.

With the principle of “Quality Parts,Customers Priority,Honest Operation,and Considerate Service”,our business mainly focus on the distribution of electronic components. Line cards we deal with include Microchip,ALPS,ROHM,Xilinx,Pulse,ON,Everlight and Freescale. Main products comprise IC,Modules,Potentiometer,IC Socket,Relay,Connector.Our parts cover such applications as commercial,industrial, and automotives areas.

We are looking forward to setting up business relationship with you and hope to provide you with the best service and solution. Let us make a better world for our industry!



Contact us

Tel: +86-755-8981 8866 Fax: +86-755-8427 6832

Email & Skype: info@chipsmall.com Web: www.chipsmall.com

Address: A1208, Overseas Decoration Building, #122 Zhenhua RD., Futian, Shenzhen, China



Subminiature Sensors with Long-distance Detection



- Shielded Sensor Heads from 3-mm to M12 diameters that can be embedded in metal.
- Robotics cables provided as a standard feature (DC 2-Wire Models).
- Indicator provided in Amplifier cable for easy confirmation of operation.
- Power supply range of 5 to 24 VDC for DC 3-Wire Models.

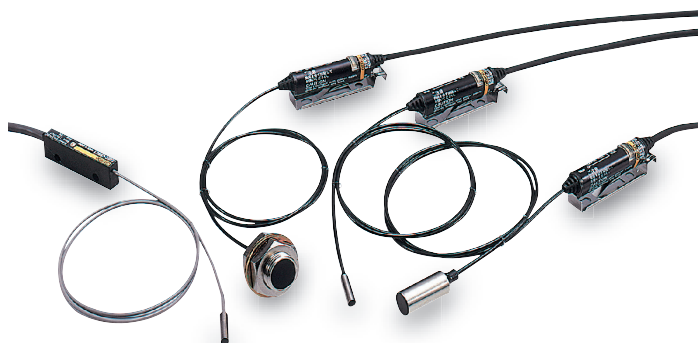

Be sure to read *Safety Precautions* on page 6.

For the most recent information on models that have been certified for safety standards, refer to your OMRON website.

Ordering Information

Sensors [Refer to *Dimensions* on page 7.]

DC 2-Wire Models

Appearance	Sensing distance			Model	
				Operation mode	
				NO	NC
	3 dia.	0.8 mm		E2EC-CR8D1 2M *	E2EC-CR8D2 2M *
	5.4 dia.	1.5 mm		E2EC-C1R5D1 2M *	E2EC-C1R5D2 2M *
	8 dia.	3 mm		E2EC-C3D1 2M *	E2EC-C3D2 2M *
	M12	4 mm		E2EC-X4D1 2M *	E2EC-X4D2 2M *

* Models with different frequencies are also available. The model numbers are E2EC-□□□□5 (example: E2EC-CR8D15).

DC 3-Wire Models

Appearance	Sensing distance			Model	
				Output configuration	NO
	3 dia.	0.5 mm	NPN open-collector output	E2EC-CR5C1 2M *1 *2	
	8 dia.	2.5 mm		E2EC-C2R5C1 2M *1 *2	

*1. Models with different frequencies are also available. The model numbers are E2EC-□□□□5 (example: E2EC-CR5D15).

*2. NC models are also available.

Accessories (Order Separately)

Mounting Bracket

The Mounting Bracket for the E2EC-C1R5D□ is not provided with the Sensor. Order a Mounting Bracket separately if required. [Refer to *Dimensions* on page 8.]

Appearance	Model	Applicable Sensors
	Y92E-F5R4	E2EC-C1R5D□ (5.4-mm-dia. Sensor)

Ratings and Specifications

Item	Model	DC 2-Wire Models				DC 3-Wire Models	
		E2EC-CR8D□	E2EC-C1R5D□	E2EC-C3D□	E2EC-X4D□	E2EC-CR5C1	E2EC-C2R5C1
Sensing distance		0.8 mm ±15%	1.5 mm ±10%	3 mm ±10%	4 mm ±10%	0.5 mm ±15%	2.5 mm ±10%
Set distance		0 to 0.56 mm	0 to 1.05 mm	0 to 2.1 mm	0 to 2.8 mm	0 to 0.3 mm	0 to 1.7 mm
Differential travel		10% max. of sensing distance					
Detectable object		Ferrous metal (The sensing distance decreases with non-ferrous metal. Refer to <i>Engineering Data</i> on page 3.)					
Standard sensing object		Iron, 5 × 5 × 1 mm		Iron, 8 × 8 × 1 mm	Iron, 12 × 12 × 1 mm	Iron, 5 × 5 × 1 mm	Iron, 8 × 8 × 1 mm
Response frequency *1		1.5 kHz		1 kHz			
Power supply voltage (operating voltage range)		12 to 24 VDC (10 to 30 VDC), ripple (p-p): 10% max.				5 to 24 VDC (4.75 to 30 VDC), ripple (p-p): 10% max.	
Current consumption		---				10 mA max.	
Leakage current		0.8 mA max.				---	
Control output	Load current	5 to 100 mA				NPN open-collector output, 100 mA max. (30 VDC max.)	
	Residual voltage	3 V max. (Load current: 100 mA, Cable length: 2 m)				1 V max. (Load current: 100 mA, Cable length: 2 m)	
Indicators		D1 Models: Operation indicator (red), Setting indicator (green) D2 Models: Operation indicator (red)				Detection indicator (red)	
Operation mode (with sensing object approaching)		D1 Models: NO D2 Models: NC Refer to the timing charts under <i>I/O Circuit Diagrams</i> on page 5 for details.				NO Refer to the timing charts under <i>I/O Circuit Diagrams</i> on page 5 for details.	
Protection circuits		Load short-circuit protection, Surge suppressor				Surge suppressor	
Ambient temperature range		Operating/Storage: -25 to 70°C (with no icing or condensation)*2					
Ambient humidity range		Operating/Storage: 35% to 95% (with no condensation)					
Temperature influence		±20% max. of sensing distance at 23°C in the temperature range of -25 to 70°C					
Voltage influence		±2.5% max. of sensing distance at rated voltage in the rated voltage ±15% range				±5% max. of sensing distance at the rated voltage range in the voltage range of 4.75 to 30 V	
Insulation resistance		50 MΩ min. (at 500 VDC) between current-carrying parts and case					
Dielectric strength		1,000 VAC for 1 min between current-carrying parts and case				500 VAC for 1 min between current-carrying parts and case	
Vibration resistance		Destruction: 10 to 55 Hz, 1.5-mm double amplitude for 2 hours each in X, Y, and Z directions					
Shock resistance		Destruction: 1,000 m/s ² 10 times each in X, Y, and Z directions				Destruction: 500 m/s ² 10 times each in X, Y, and Z directions	
Degree of protection		IEC 60529 IP67, In-house standards: oil-resistant (For Sensor Head only)				IEC 60529 IP64	
Connection method		Pre-wired Models (Standard cable length: 2 m)					
Weight (packed state)		Approx. 45 g					
Materials	Case	Brass					
	Sensing surface	ABS					
	Clamping nut	---			Brass (nickel-plated)	---	
	Toothed washer	---			Iron (zinc-plated)	---	
Accessories		Amplifier Mounting Bracket, Instruction manual				Instruction manual	

*1. The response frequency is an average value.

Measurement conditions are as follows: standard sensing object, a distance of twice the standard sensing object, and a set distance of half the sensing distance.

*2. Incorrect operation may occur if there is a large temperature difference between the Sensor Head and the Amplifier Unit.

Engineering Data (Reference Value)

Sensing Area

E2EC-CR8D1

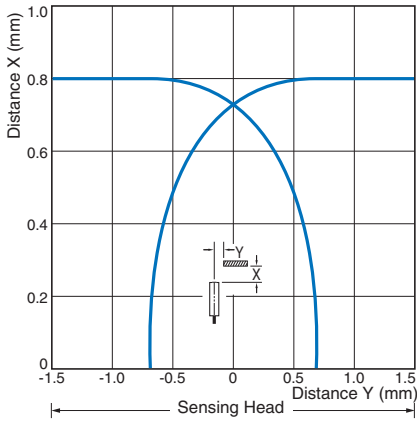

E2EC-C1R5D1

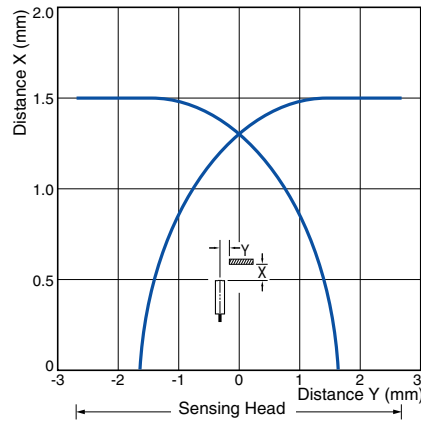

E2EC-C3D1

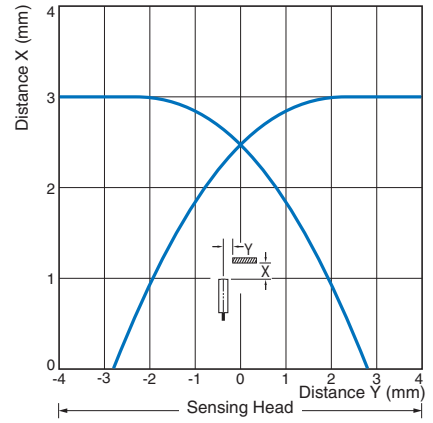

E2EC-X4D1

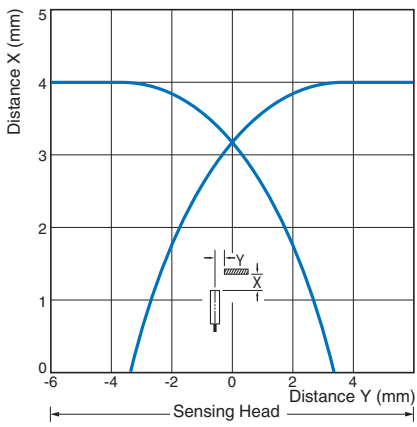

E2EC-CR5C1

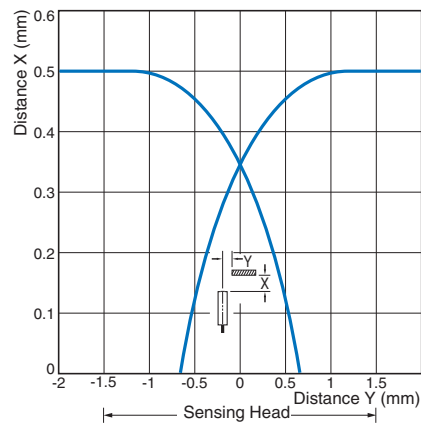

E2EC-C2R5C1

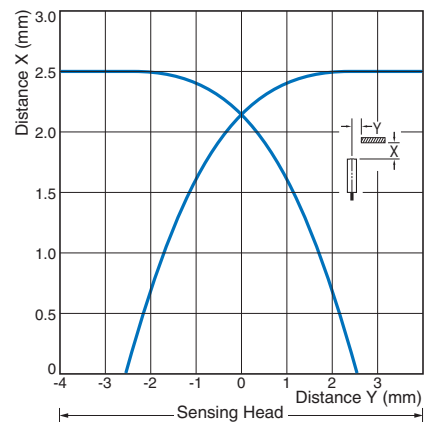

Influence of Sensing Object Size and Material

E2EC-CR8D1

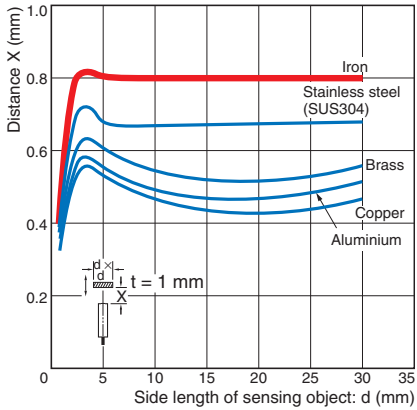

E2EC-C1R5D1

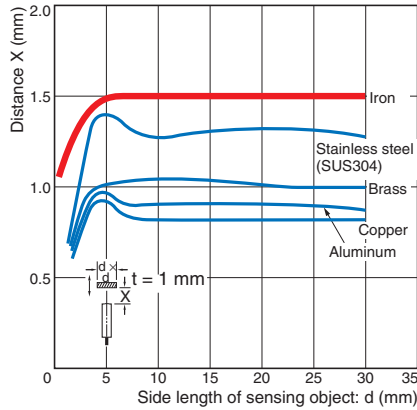

E2EC-C3D1

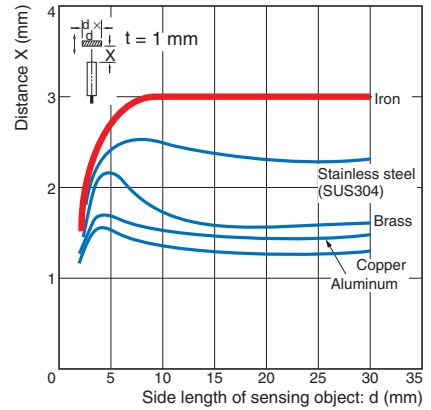

E2EC-X4D1

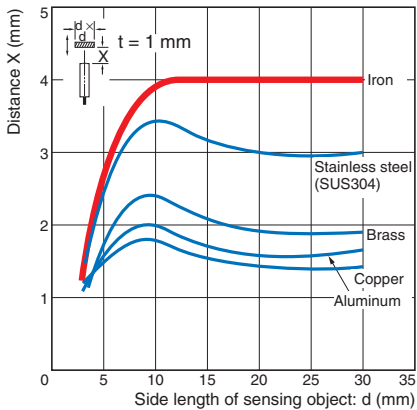

E2EC-CR5C1

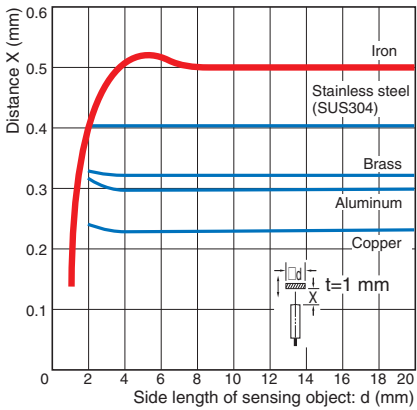

E2EC-C2R5C1

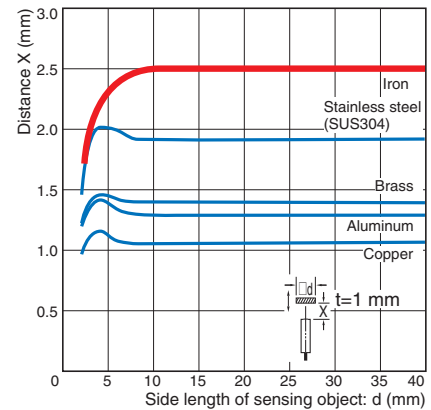

Residual Output Voltage

DC 2-Wire Models

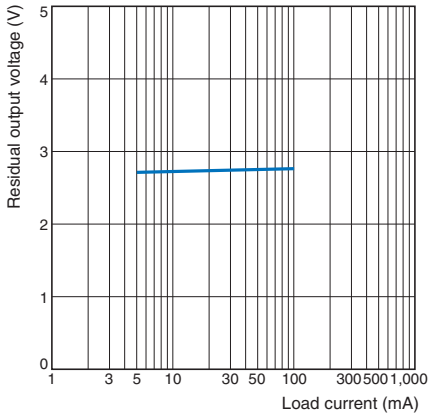

Leakage Current

E2EC

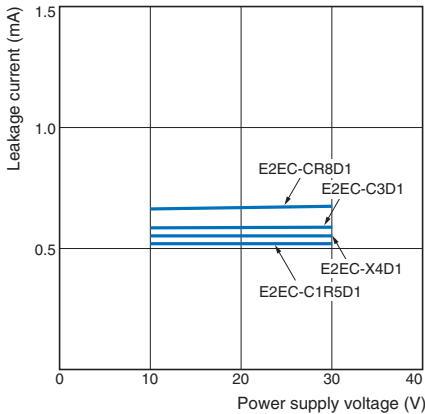

I/O Circuit Diagrams

DC 2-Wire Models

Operation	Model	Timing Chart	Output circuit
NO	E2EC-CR8D1 E2EC-C1R5D1 E2EC-C3D1 E2EC-X4D1		<p>Note: The load can be connected to either the +V or 0 V side.</p>
NC	E2EC-CR8D2 E2EC-C1R5D2 E2EC-C3D2 E2EC-X4D2		<p>Note: The load can be connected to either the +V or 0 V side.</p>

DC 3-Wire Models

Operation	Model	Timing Chart	Output circuit
NO	E2EC-CR5C1 E2EC-C2R5C1		<p>Maximum load current: 100 mA</p> <p>Note: The Sensor may be destroyed if mistakes are made in wiring.</p>

Safety Precautions

Refer to *Warranty and Limitations of Liability*.

WARNING

This product is not designed or rated for ensuring safety of persons either directly or indirectly. Do not use it for such purposes.



Precautions for Correct Use

Do not use this product under ambient conditions that exceed the ratings.

● Design

Influence of Surrounding Metal

When mounting the Sensor within a metal panel, ensure that the clearances given in the following table are maintained. Failure to maintain these distances may cause deterioration in the performance of the Sensor.

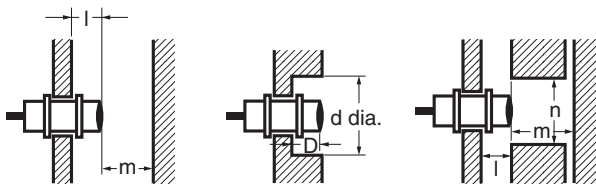

Influence of Surrounding Metal (Unit: mm)

Model	Item	l	d	D	m	n
E2EC-CR8D□		0	3	0	2.4	6
E2EC-C1R5D□			5.4		4.5	10.8
E2EC-C3D□			8		9	16
E2EC-X4D□			12		12	24
E2EC-CR5C1			3		1.5	5
E2EC-C2R5C1			8		10	21

Influence of Temperature

Incorrect operation may occur if there is a large temperature difference between the Sensor Head and the Amplifier Unit.

Mutual Interference

When installing Sensors face-to-face or side-by-side, ensure that the minimum distances given in the following table are maintained.

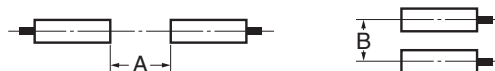

Mutual Interference (Unit: mm)

Model	Item	A	B
E2EC-CR8D□		18 (4) *1	6 (3) *1 *2
E2EC-C1R5D□		15 (8) *1	10.8 (5.4) *1 *2
E2EC-C3D□		30 (15) *1	16 (8) *1 *2
E2EC-X4D□		40 (20) *1	24 (12) *1 *2
E2EC-CR5C1		20 (10) *1	15 (3) *1 *2
E2EC-C2R5C1		40 (20) *1	25 (15) *1

*1. Values in parentheses apply to Sensors operating at different frequencies.
*2. Mutual interference will not occur for close-proximity mounting if models with different frequencies are used together.

● Mounting

- Refer to the following table for the torque and tightening ranges applied to mount the E2EC-C Unthreaded Cylindrical Model. Tightening must be as given in the following table.

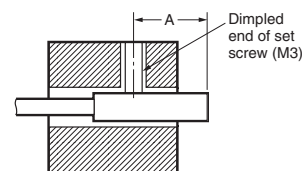

Permissible Tightening Range and Torque

Model	Tightening	Set screw tightening
E2EC-CR8D□	6 to 10 mm	0.49 N·m
E2EC-C1R5D□	8 to 16 mm	
E2EC-C3D□		0.98 N·m
E2EC-CR5C1	6 to 10 mm	0.39 N·m
E2EC-C2R5C1	8 to 16 mm	

- The tightening torque applied to the E2EC-X4D□ Threaded Cylindrical Models must be 12 N·m max.



Amplifier Mounting Bracket for DC 2-Wire Models

Mounting

- Insert the Amplifier into the trapezoidal end (i.e., the fixing side) of the Mounting Bracket.

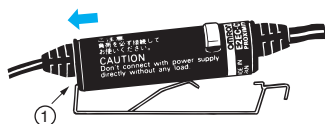

- Press the other end of the Amplifier onto the Bracket.

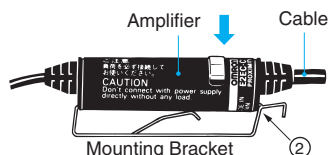

Dismounting

- Lightly press the hook on the Mounting Bracket with a flat-blade screwdriver.

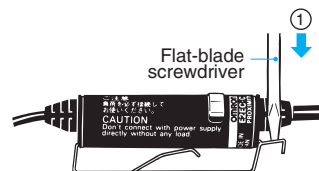

- The Amplifier will be automatically released due to the spring force of the Mounting Bracket.



Dimensions

Tolerance class IT16 applies to dimensions in this data sheet unless otherwise specified.

Main Units

E2EC-CR8D

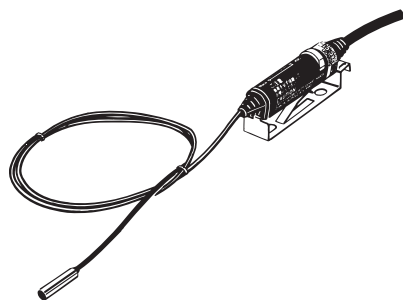

With Mounting Bracket Attached

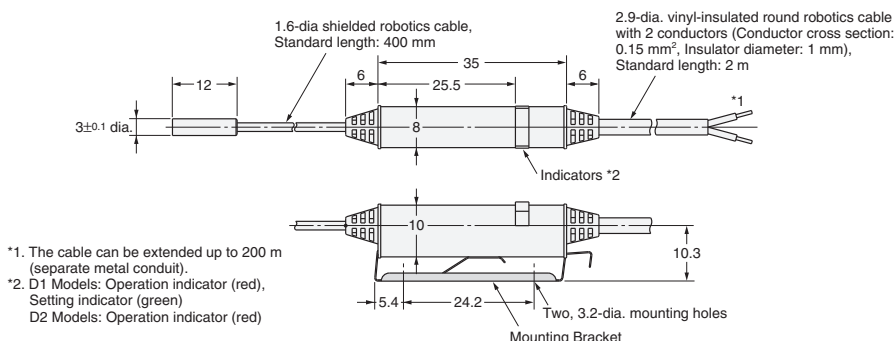

E2EC-C1R5D

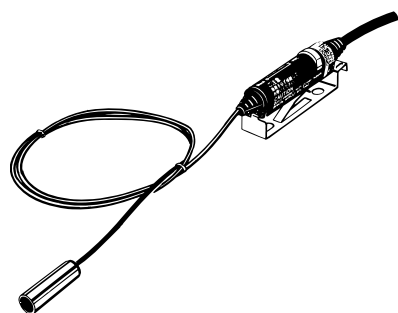

With Mounting Bracket Attached

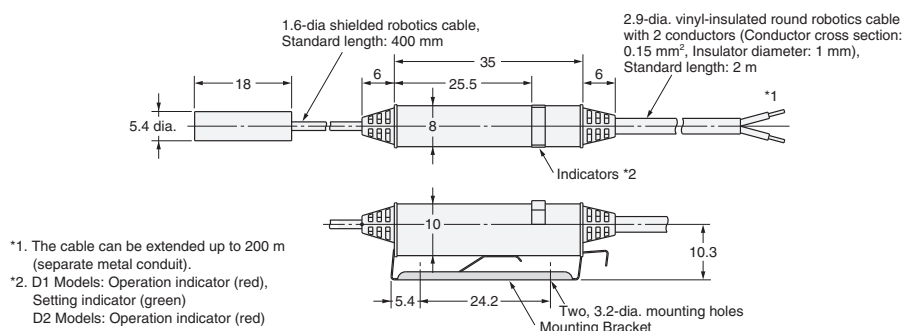

E2EC-C3D

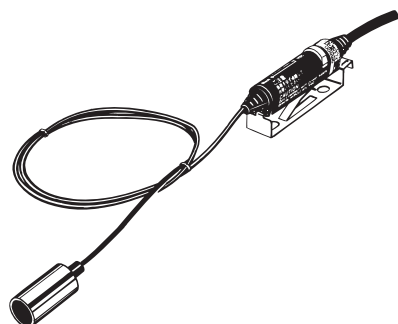

With Mounting Bracket Attached

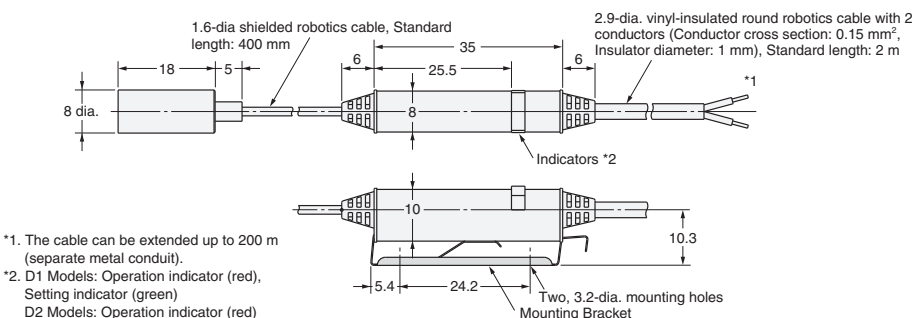

E2EC-X4D

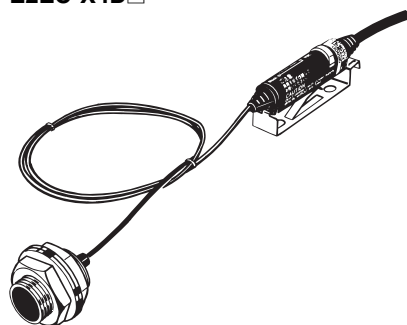

With Mounting Bracket Attached

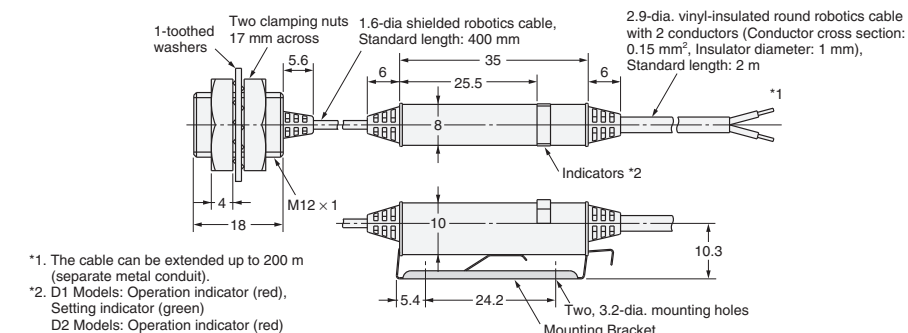

Mounting Hole Dimensions



Model	F (mm)
E2EC-CR8D	3.3 ^{+0.3} / ₀ dia.
E2EC-C1R5D	5.7 ^{+0.3} / ₀ dia.
E2EC-C3D	8.5 ^{+0.5} / ₀ dia.
E2EC-X4D	12.5 ^{+0.5} / ₀ dia.

E2EC-CR5C1

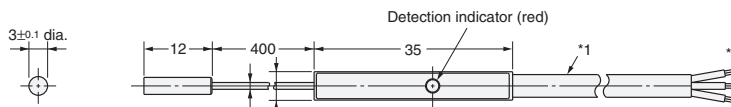
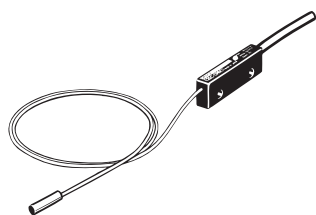

- *1. 4-dia. vinyl-insulated round cable with 3 conductors (Conductor cross section: 0.2 mm², Insulator diameter: 1.2 mm), Standard length: 2 m
- *2. The cable can be extended up to 50 m (separate metal conduit).
- *3. 1.2-dia shielded cable, Standard length: 400 mm

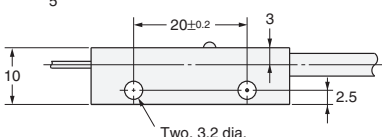

Mounting Hole Dimensions

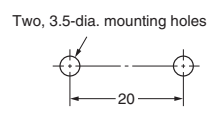

E2EC-C2R5C1

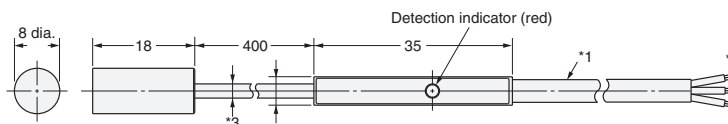
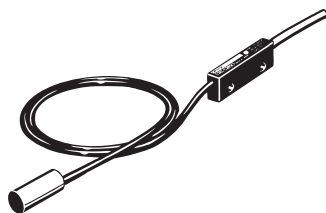

- *1. 4-dia. vinyl-insulated round cable with 3 conductors (Conductor cross section: 0.2 mm², Insulator diameter: 1.2 mm), Standard length: 2 m
- *2. The cable can be extended up to 50 m (separate metal conduit).
- *3. 2.5-dia shielded cable, Standard length: 400 mm

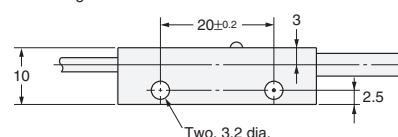

Mounting Hole Dimensions

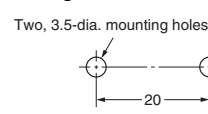

Mounting Hole Dimensions

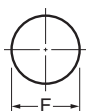

Model	F (mm)
E2EC-CR5C1	3.3 ^{+0.3} / ₀ dia.
E2EC-C2R5C1	8.5 ^{+0.5} / ₀ dia.

Mounting Bracket

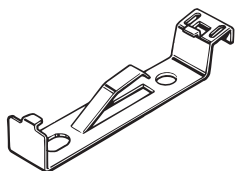

Material: Stainless steel (SUS301)
 Note: Provided with DC 2-Wire Models.

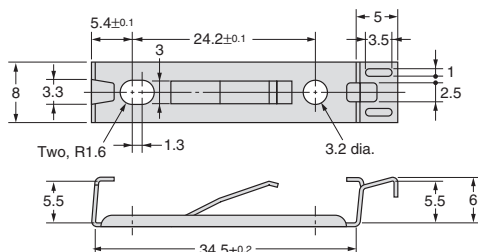

Accessories (Order Separately)

Mounting Bracket (for 5.4 dia.)

Y92E-F5R4



Material: Stainless steel (SUS304)
 Note: Used for E2EC-C1R5D□ Head.

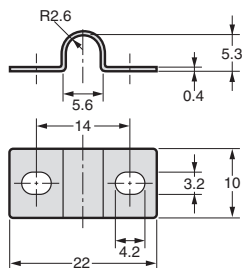

Terms and Conditions Agreement

Read and understand this catalog.

Please read and understand this catalog before purchasing the products. Please consult your OMRON representative if you have any questions or comments.

Warranties.

(a) Exclusive Warranty. Omron's exclusive warranty is that the Products will be free from defects in materials and workmanship for a period of twelve months from the date of sale by Omron (or such other period expressed in writing by Omron). Omron disclaims all other warranties, express or implied.

(b) Limitations. OMRON MAKES NO WARRANTY OR REPRESENTATION, EXPRESS OR IMPLIED, ABOUT NON-INFRINGEMENT, MERCHANTABILITY OR FITNESS FOR A PARTICULAR PURPOSE OF THE PRODUCTS. BUYER ACKNOWLEDGES THAT IT ALONE HAS DETERMINED THAT THE PRODUCTS WILL SUITABLY MEET THE REQUIREMENTS OF THEIR INTENDED USE.

Omron further disclaims all warranties and responsibility of any type for claims or expenses based on infringement by the Products or otherwise of any intellectual property right. (c) Buyer Remedy. Omron's sole obligation hereunder shall be, at Omron's election, to (i) replace (in the form originally shipped with Buyer responsible for labor charges for removal or replacement thereof) the non-complying Product, (ii) repair the non-complying Product, or (iii) repay or credit Buyer an amount equal to the purchase price of the non-complying Product; provided that in no event shall Omron be responsible for warranty, repair, indemnity or any other claims or expenses regarding the Products unless Omron's analysis confirms that the Products were properly handled, stored, installed and maintained and not subject to contamination, abuse, misuse or inappropriate modification. Return of any Products by Buyer must be approved in writing by Omron before shipment. Omron Companies shall not be liable for the suitability or unsuitability or the results from the use of Products in combination with any electrical or electronic components, circuits, system assemblies or any other materials or substances or environments. Any advice, recommendations or information given orally or in writing, are not to be construed as an amendment or addition to the above warranty.

See <http://www.omron.com/global/> or contact your Omron representative for published information.

Limitation on Liability; Etc.

OMRON COMPANIES SHALL NOT BE LIABLE FOR SPECIAL, INDIRECT, INCIDENTAL, OR CONSEQUENTIAL DAMAGES, LOSS OF PROFITS OR PRODUCTION OR COMMERCIAL LOSS IN ANY WAY CONNECTED WITH THE PRODUCTS, WHETHER SUCH CLAIM IS BASED IN CONTRACT, WARRANTY, NEGLIGENCE OR STRICT LIABILITY.

Further, in no event shall liability of Omron Companies exceed the individual price of the Product on which liability is asserted.

Suitability of Use.

Omron Companies shall not be responsible for conformity with any standards, codes or regulations which apply to the combination of the Product in the Buyer's application or use of the Product. At Buyer's request, Omron will provide applicable third party certification documents identifying ratings and limitations of use which apply to the Product. This information by itself is not sufficient for a complete determination of the suitability of the Product in combination with the end product, machine, system, or other application or use. Buyer shall be solely responsible for determining appropriateness of the particular Product with respect to Buyer's application, product or system. Buyer shall take application responsibility in all cases.

NEVER USE THE PRODUCT FOR AN APPLICATION INVOLVING SERIOUS RISK TO LIFE OR PROPERTY OR IN LARGE QUANTITIES WITHOUT ENSURING THAT THE SYSTEM AS A WHOLE HAS BEEN DESIGNED TO ADDRESS THE RISKS, AND THAT THE OMRON PRODUCT(S) IS PROPERLY RATED AND INSTALLED FOR THE INTENDED USE WITHIN THE OVERALL EQUIPMENT OR SYSTEM.

Programmable Products.

Omron Companies shall not be responsible for the user's programming of a programmable Product, or any consequence thereof.

Performance Data.

Data presented in Omron Company websites, catalogs and other materials is provided as a guide for the user in determining suitability and does not constitute a warranty. It may represent the result of Omron's test conditions, and the user must correlate it to actual application requirements. Actual performance is subject to the Omron's Warranty and Limitations of Liability.

Change in Specifications.

Product specifications and accessories may be changed at any time based on improvements and other reasons. It is our practice to change part numbers when published ratings or features are changed, or when significant construction changes are made. However, some specifications of the Product may be changed without any notice. When in doubt, special part numbers may be assigned to fix or establish key specifications for your application. Please consult with your Omron's representative at any time to confirm actual specifications of purchased Product.

Errors and Omissions.

Information presented by Omron Companies has been checked and is believed to be accurate; however, no responsibility is assumed for clerical, typographical or proofreading errors or omissions.

2015.8

In the interest of product improvement, specifications are subject to change without notice.

OMRON Corporation
Industrial Automation Company

<http://www.ia.omron.com/>

(c)Copyright OMRON Corporation 2015 All Right Reserved.