



Chipsmall Limited consists of a professional team with an average of over 10 year of expertise in the distribution of electronic components. Based in Hongkong, we have already established firm and mutual-benefit business relationships with customers from,Europe,America and south Asia,supplying obsolete and hard-to-find components to meet their specific needs.

With the principle of “Quality Parts,Customers Priority,Honest Operation,and Considerate Service”,our business mainly focus on the distribution of electronic components. Line cards we deal with include Microchip,ALPS,ROHM,Xilinx,Pulse,ON,Everlight and Freescale. Main products comprise IC,Modules,Potentiometer,IC Socket,Relay,Connector.Our parts cover such applications as commercial,industrial, and automotives areas.

We are looking forward to setting up business relationship with you and hope to provide you with the best service and solution. Let us make a better world for our industry!



Contact us

Tel: +86-755-8981 8866 Fax: +86-755-8427 6832

Email & Skype: info@chipsmall.com Web: www.chipsmall.com

Address: A1208, Overseas Decoration Building, #122 Zhenhua RD., Futian, Shenzhen, China



Ideal for Detecting Glass Wafers and Other Transparent Objects

- Detects glass wafers and LCD glass circuit boards.



Be sure to read *Safety Precautions* on page 7.

Ordering Information

Sensors

Compact Models with Plastic Housing (Refer to *Dimensions* on page 8.)





Red light Infrared light

Sensing method	Appearance	Connection method	Sensing distance	Model		Recommended application *2	
				NPN	PNP	Flat object	Cylindrical object
						Detecting glass wafers and LCD glass circuit boards	Detecting plastic bottles and other transparent containers
Retro-reflective	Horizontal	Pre-wired (2 m)	300 mm [100 mm] *1	E3S-R12 2M	---	Ideal	Ideal
			1 m [100 mm] *1	E3S-R11 2M	E3S-R31 2M	Ideal	---
		Standard M12 Connector	300 mm [100 mm] *1	E3S-R17	---	Ideal	Ideal
			1 m [100 mm] *1	E3S-R16	E3S-R36	Ideal	---
	Vertical	Pre-wired (2 m)	300 mm [100 mm] *1	E3S-R62 2M	---	Ideal	Ideal
			1 m [100 mm] *1	E3S-R61 2M	E3S-R81 2M	Ideal	---
		Standard M12 Connector	300 mm [100 mm] *1	E3S-R67	---	Ideal	Ideal
			1 m [100 mm] *1	E3S-R66	E3S-R86	Ideal	---

*1. Values in parentheses indicate the minimum required distance between the Sensor and Reflector.

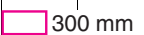
*2. The E3S-R may not detect some glass wafer materials or plastic bottle shapes. Before using the E3S-R, be sure to test it on samples to make sure it can detect the items reliably.

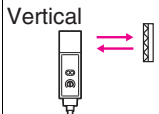
Models with Metal Housing (Refer to *Dimensions* on page 10.)
 Red light

Sensing method	Appearance	Connection method	Sensing distance		Model	Recommended application *	
						Flat object	Cylindrical object
						Detecting glass wafers and LCD glass circuit boards	Detecting plastic bottles and other transparent containers
Retro-reflective	Horizontal 	Pre-wired		300 mm	E3S-RS30E4 2M	--	Ideal
				1 m	E3S-R1E4 2M	--	Applicable
	Vertical 			300 mm	E3S-RS30E42 2M	--	Ideal
				1 m	E3S-R1E42 2M	--	Applicable

* The E3S-R may not detect some glass wafer materials or plastic bottle shapes. Before using the E3S-R, be sure to test it on samples to make sure it can detect the items reliably.

Accessories (Order Separately)

Sensitivity Adjuster/Screwdriver (Refer to *Dimensions* on E39-L/F39-L/E39-S/E39-R.)







Name	Model	Quantity	Remarks
Sensitivity adjuster	E39-G1	1	Provided with the E3S-RS30E4□ and E3S-R1E4□.
Screwdriver for sensitivity adjustment	E39-G2	1	Provided with the E3S-R1□, E3S-R3□, E3S-R6□, and E3S-R8□.

Reflector (Refer to *Dimensions* on E39-L/F39-L/E39-S/E39-R.)

Name	Sensing distance	Model	Quantity	Remarks
Reflector	Refer to <i>Ratings and Specifications</i> .	E39-R1	1	Provided with the E3S-R.

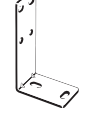

Note: Refer to Reflectors on E39-L/F39-L/E39-S/E39-R for details.

Mounting Brackets and Other Products (Refer to *Dimensions* on E39-L/F39-L/E39-S/E39-R.)

Appearance	Model	Quantity	Remarks
	E39-L69	1	Provided with the E3S-R1□ and E3S-R3□.
	E39-L70	1	Provided with the E3S-R6□ and E3S-R8□.
	E39-L6	1	Provided with the E3S-RS30E4□ and E3S-R1E4□.
	E39-L2	1	Can be used with the E3S-RS30E4□ and E3S-R1E4□.
	E39-L97	1	Horizontal protective cover bracket Can be used for compact models with plastic housing. Refer to E39-L□.
	E39-L98	1	Vertical protective cover bracket Can be used for compact models with plastic housing. Refer to E39-L□.
	E39-L60	1	Close Mounting Plate Provided with the E3S-R□6 and E3S-R□7.

Note: 1. When using through-beam models, order one bracket for the Receiver and one for the Emitter.
2. Refer to Mounting Brackets on E39-L/F39-L/E39-S/E39-R for details.

Sensor I/O Connectors (M12) (Refer to Dimensions on XS2.)

Cable	Appearance	Cable type		Model
Standard	Straight 	2 m	3-wire	XS2F-D421-DC0-F
		5 m		XS2F-D421-GC0-F
	L-shape 	2 m		XS2F-D422-DC0-F
		5 m		XS2F-D422-GC0-F

Note: For details on Sensor I/O Connectors and cables such as vibration-proof robot cables, refer to *Introduction to Sensor I/O Connectors/Sensor Controllers*.

Ratings and Specifications

Item	Sensing method Model	Retro-reflective		Retro-reflective	
		Retro-reflective		Retro-reflective	
		NPN	E3S-R12, R62, R17, R67	E3S-R11, R16, R61, R66	E3S-RS30E4, RS30E42
	PNP	---	E3S-R31, R36, R81, R86	---	---
Sensing distance		300 mm [100 mm] *2 (When using E39-R1)	1 m [100 mm] *2 (When using E39-R1)	300 mm (When using E39-R1)	1 m (When using E39-R1)
Standard sensing object		Opaque: 75-mm dia. min. 0.7-mm-thick LCD glass boards; 10-mm-dia., 1.0-mm-thick, 30-mm-long cylindrical glass objects	Opaque: 75-mm dia. min. 0.7-mm-thick LCD glass boards	Opaque: 75-mm dia. min. 10-mm-dia., 1.0-mm-thick, 30-mm-long cylindrical glass objects	
Directional angle		3° to 10°		---	
Light source (wavelength)		Infrared LED (880 nm)	Red LED (700 nm)	Infrared LED (950 nm)	
Power supply voltage		10 to 30 VDC; ripple: 10% max.		12 to 24 VDC±10%; ripple: 10% max.	
Current consumption		30 mA max.		40 mA max.	
Control output		Load power supply voltage: 30 VDC max. Load current: 100 mA max. with a maximum residual voltage of 1 V Open collector output configuration Light-ON/Dark-ON selector switch		Load power supply voltage: 24 VDC max Load current: 80 mA max. with a maximum residual voltage of 2 V NPN voltage output configuration Light-ON/Dark-ON cable connection selection	
Protection circuits		Power supply reverse polarity protection, Output short-circuit protection, Mutual interference prevention			
Response time		Operate or reset: 1 ms max.			
Sensitivity adjustment		Two-turn endless adjuster		One-turn adjuster	
Ambient illumination (Receiver side)		Incandescent lamp: 5,000 lx max. Sunlight: 10,000 lx max.		Incandescent lamp: 3,000 lx max. Sunlight: 10,000 lx max.	
Ambient temperature range		Operating: 0 to 40°C, Storage: -40 to 70°C (with no icing or condensation)			Operating: -25 to 55°C Storage: -40 to 70°C (with no icing or condensation)
Ambient humidity range		Operating: 35% to 85%, Storage: 35% to 95% (with no condensation)			
Insulation resistance		20 MΩ min. (at 500 VDC)			
Dielectric strength		1,000 VAC, 50/60 Hz for 1 min			
Vibration resistance		Destruction: 10 to 55 Hz, 1.5-mm double amplitude for 2 h each in X, Y, and Z directions			
Shock resistance		Destruction: 500 m/s ² for 3 times each in X, Y, and Z directions			
Degree of protection		IEC 60529 IP67			
Connection method		Pre-wired (standard length: 2 m)/Standard connector			
Weight (packed state)		Pre-wired models: Approx. 110 g Standard connector: Approx. 60 g		Pre-wired models: Approx. 190 g	
Materials	Case	Polybutylene terephthalate		Zinc die-cast	
	Lens	Modified polyallylate		Polycarbonate	
	Mounting Bracket	Stainless steel (SUS304)		Iron	
Accessories		Mounting Bracket (with screw), Adjustment screwdriver, Instruction manual, Reflector		Mounting Bracket (with screw), Adjustment screwdriver, Sensitivity adjuster, Instruction manual, Reflector	

*1. Refer to *MSR function of Technical Guide (Technical version)*.

*2. Values in parentheses indicate the minimum required distance between the Sensor and Reflector.

Engineering Data (Reference Value)

Parallel Operating Range

Retro-reflective

E3S-R12, E3S-R62 + E39-R1
(Supplied Reflector)

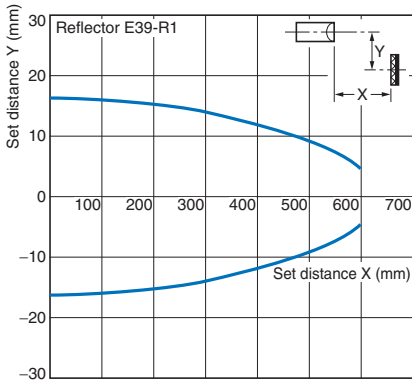

Retro-reflective

E3S-R□1, E3S-R□6 + E39-R1
(Supplied Reflector)

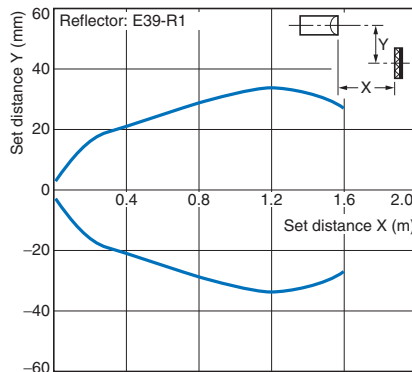

Retro-reflective

E3S-RS30E4□ + E39-R1
(Supplied Reflector)

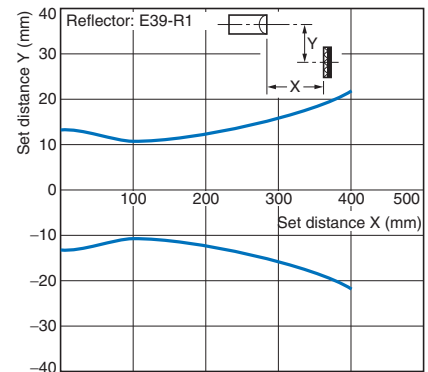

Retro-reflective

E3S-R1E4□ + E39-R1
(Supplied Reflector)

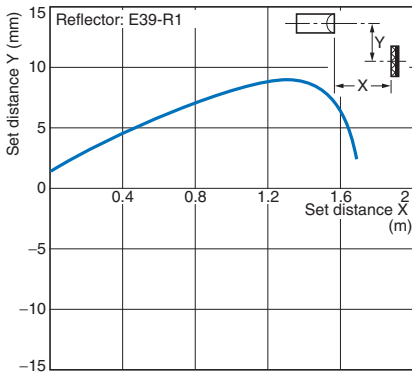

Excess Gain vs. Set Distance

E3S-R12, E3S-R62 + E39-R1
(Supplied Reflector)

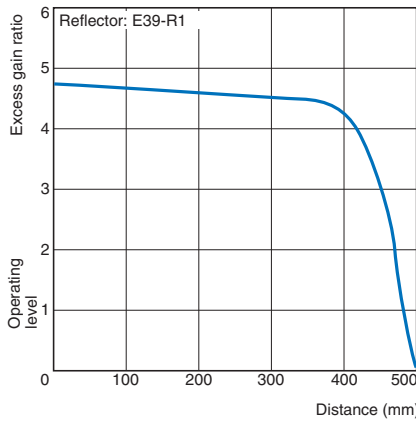

E3S-R□1, E3S-R□6 + E39-R1
(Supplied Reflector)

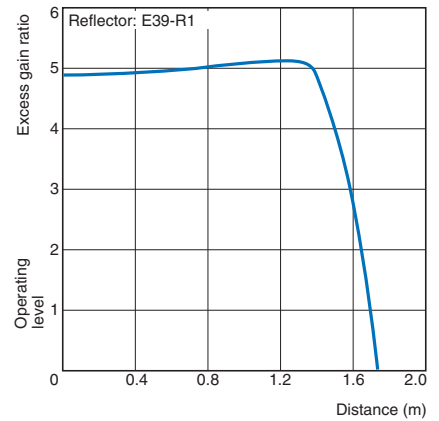

E3S-RS30E4□ + E39-R1
(Supplied Reflector)

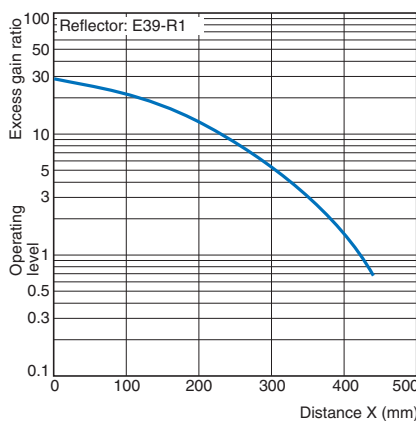

E3S-R1E4□ + E39-R1
(Supplied Reflector)

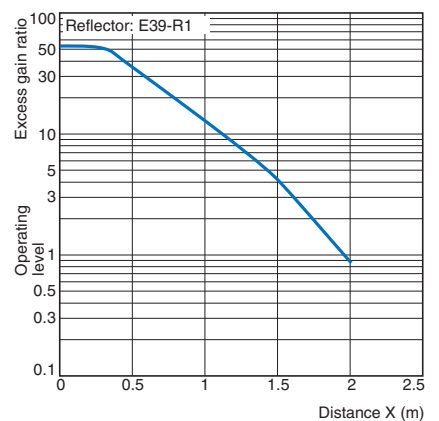

Light Level Change Rates with Various Transparent Objects (*1)

The following are the permeation rates of various transparent objects on condition that a permeation rate of 100 means that there is no object within the sensing distance of the E3S-R. The permeation rate of any type of object sensed by the E3S-R must be as low as possible for reliable detection of the object. Before using the E3S-R, be sure to test it on samples to make sure it can detect the items reliably.

Sensing object Appearance	Model Through position	E3S-R12, R62 E3S-R17, R67	E3S-R11, R31, R61, R81 E3S-R16, R36, R66, R86	E3S-RS30□□	E3S-R1□□
		Center	Center	Center	Center
Cylindrical glass object	10 dia. × 30, t = 1.0	27	---	20	33
	15 dia. × 30, t = 1.25	27	---	20	13
	20 dia. × 30, t = 1.7	22	---	28	13
	30 dia. × 30, t = 1.9	41	---	43	23
	100 dia. × 30, t = 2.5	58	---	55	50
	200 dia. × 30, t = 5.0	55	---	58	58
Glass plate	50 × 50, t = 0.5	82	82	78	---
	50 × 50, t = 1	74	74	70	75
	50 × 50, t = 2	73	73	70	75
	50 × 50, t = 3	62	62	58	65
	50 × 50, t = 5	53	53	50	55
	50 × 50, t = 10	38	38	35	40
Liquid crystal glass	t = 0.5 (permeability of 98%) *2	86	86	---	---
	t = 0.7 (permeability of 95%) *2	81	81	---	---
	t = 1.1 (permeability of 91%) *2	75	75	---	---
Operating range		95 max.	95 max.	90 max.	80 max.
Stable operating range		90 max.	90 max.	70 max.	60 max.

*1. The sensing distance of each model was set to the rated sensing distance.
 *2. The permeability values were checked with light at a wavelength of 700 μm.

I/O Circuit Diagrams

NPN Output

Model	Operation mode	Timing Charts	Operation selector	Output circuit
E3S-R11(12) E3S-R61(62) E3S-R16(17) E3S-R66(67)	Light-ON	<p>Incident light: ON (green bar), No incident light: OFF (white bar)</p> <p>Light indicator (Red): ON (green bar), OFF (white bar)</p> <p>Output transistor: ON (green bar), OFF (white bar)</p> <p>Load (e.g., relay): Operate (green bar), Reset (white bar)</p> <p>(Between brown and black leads)</p>	L side (LIGHT ON)	<p>Connector Pin Arrangement</p> <p>Note: Pin 2 is not used.</p>
	Dark-ON	<p>Incident light: ON (green bar), No incident light: OFF (white bar)</p> <p>Light indicator (Red): ON (green bar), OFF (white bar)</p> <p>Output transistor: ON (green bar), OFF (white bar)</p> <p>Load (e.g., relay): Operate (green bar), Reset (white bar)</p> <p>(Between brown and black leads)</p>	D side (DARK ON)	

PNP Output

Model	Operation mode	Timing Charts	Operation selector	Output circuit
E3S-R31 E3S-R36 E3S-R81 E3S-R86	Light-ON	Incident light: ON (Green bar) No incident light: OFF (White bar) Light indicator (Red): OFF (White bar) Output transistor: ON (Green bar) Load (e.g., relay): Operate (Green bar) Reset: OFF (White bar) (Between blue and black leads)	L side (LIGHT ON)	<p>Connector Pin Arrangement</p> <p>Note: Pin 2 is not used.</p>
	Dark-ON	Incident light: OFF (White bar) No incident light: ON (Green bar) Light indicator (Red): ON (Green bar) Output transistor: OFF (White bar) Load (e.g., relay): Operate (Green bar) Reset: OFF (White bar) (Between blue and black leads)	D side (DARK ON)	

Plug (Sensor I/O Connector)

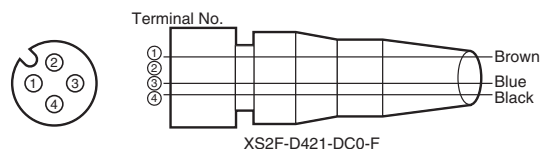

Classification	Wire color	Connection pin No.	Application
DC	Brown	1	Power supply (+V)
	---	2	---
	Blue	3	Power supply (0 V)
	Black	4	Output

Note: Pin 2 is not used.

Refer to *Introduction to Sensor I/O Connectors/Sensor Controllers* for details.

Model	Operation mode	Timing Charts	Cable Connection	Output circuit
E3S-RS30E4(42) E3S-R1E4(42)	Light-ON	Incident light: ON (Green bar) No incident light: OFF (White bar) Light indicator (Red): ON (Green bar) Output transistor: ON (Green bar) Load 1 (e.g., relay): Operate (Green bar) Load 2: Operate (Green bar) Reset: OFF (White bar) (Between brown and black leads) H (Between brown and black leads) L (Between blue and black leads)	Brown cable: +V Blue cable: 0 V	
	Dark-ON	Incident light: OFF (White bar) No incident light: ON (Green bar) Light indicator (Red): OFF (White bar) Output transistor: OFF (White bar) Load 1 (e.g., relay): Operate (Green bar) Load 2: Operate (Green bar) Reset: OFF (White bar) (Between blue and black leads) H (Between brown and black leads) L (Between brown and black leads)	Brown cable: 0 V Blue cable: +V	

*1. Reverse the polarity of the power supply to change the output mode of the E3S-R.
 *2. Voltage output (When connecting a transistor circuit, etc.)

Safety Precautions

Be sure to read the precautions for all models in the website at: <http://www.ia.omron.com/>.

Warning Indications

 WARNING	Warning level Indicates a potentially hazardous situation which, if not avoided, will result in minor or moderate injury, or may result in serious injury or death. Additionally there may be significant property damage.
Precautions for Safe Use	Supplementary comments on what to do or avoid doing, to use the product safely.
Precautions for Correct Use	Supplementary comments on what to do or avoid doing, to prevent failure to operate, malfunction or undesirable effect on product performance.

Meaning of Product Safety Symbols

	General prohibition Indicates the instructions of unspecified prohibited action.
---	--

WARNING

This product is not designed or rated for ensuring safety of persons either directly or indirectly. Do not use it for such purposes.



Precautions for Safe Use

The following precautions must be observed to ensure safe operation.

- Doing so may cause damage or fire. Do not install the product in the following locations.
 - Locations subject to direct sunlight
 - Locations subject to condensation due to high humidity
 - Locations subject to corrosive gas
 - Locations subject to vibration or mechanical shocks exceeding the rated values
 - Locations subject to steam
 - Locations subject to strong magnetic field or electric field
- Do not use the product in environments subject to flammable or explosive gases.
- Do not use a voltage in excess of the operating voltage range. Applying a voltage in excess of the operating voltage range, or applying AC power to a DC Sensor may cause explosion or burning.
- Doing so may cause damage, fire, explosion or malfunction.
 - Never use the product with damaged body or cable.
 - Never disassemble, repair nor tamper with the product.
 - Never use the product with incorrect power supply or wiring.
- Do not short the load. Otherwise explosion or burning may result.
- Do not use the Sensor in environments where the cables may become immersed in oil or other liquids or where liquids may penetrate the Sensor. Doing so may result in damage from burning and fire, particularly if the liquid is flammable.
- Do not use in water or outside.
- When disposing of the product, treat it as industrial waste.

Precautions for Correct Use

- Do not use the product in any atmosphere or environment that exceeds the ratings.
- Use the following tightening torque for the Sensor mounting screws.
 - M3 screws: 0.5 N·m max.
 - M4 screws: 1.2 N·m max.
- Do not apply the forces on the cable exceeding the following limits: Pull: 40 N; torque: 0.1 N·m; pressure: 20 N; bending: 29.4 N
- Make sure to tighten the connectors.
- It may take time until the incident level and measurement value become stable immediately after the power is turned on depending on use environment.
- Burn injury may occur. The product surface temperature rises depending on application conditions, such as the ambient temperature and the power supply voltage. Attention must be paid during operation or cleaning.

● Adjusting

- When the E3S-R senses a cylindrical object, the amount of light received varies with the direction of the cylindrical object. To prevent this, locate the E3S-R as shown in the following illustration.

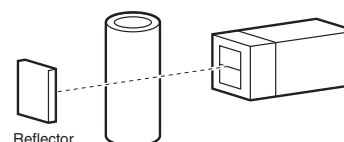

- When the E3S-R senses an uneven plastic container or glass bottle, the amount of light received varies with the direction and sensing part of the plastic container or glass bottle. To prevent this, turn a sample of the plastic container or glass bottle to the best sensing position of the E3S-R to find and decide the optimum direction and sensing part, and then make the sensitivity adjustment.
- In principle, sensing objects must pass through the center between the E3S-R and the reflector. Sensing objects must not be too close to the Reflector, otherwise sensing errors may result.
- Unless otherwise indicated, the E39-R1 Reflector is required for transparent object detection. The Receiver may not receive any light and detection capability may decline with other Reflectors.

Dimensions

Sensors

Compact Horizontal Models with Plastic Housing

Pre-wired Models
E3S-R11, E3S-R12
E3S-R31

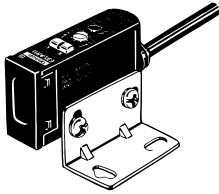

With Mounting Bracket Attached

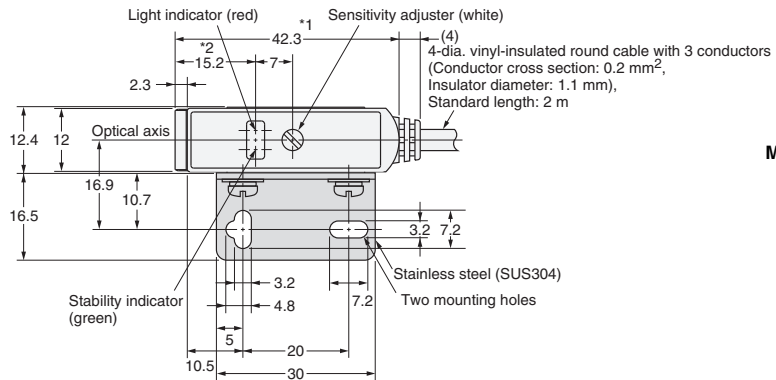

Mounting Holes

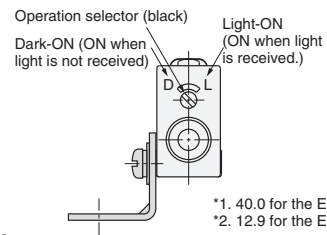
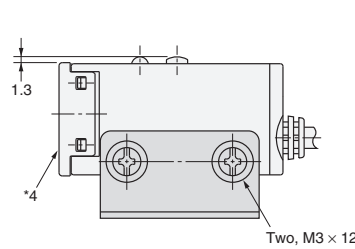
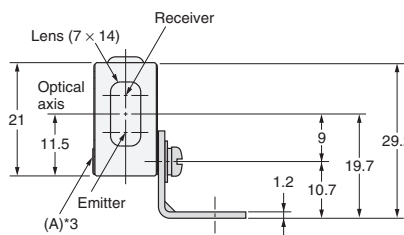
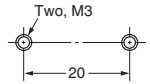

*1. 40.0 for the E3S-R12
*2. 12.9 for the E3S-R12.

*3. The mounting bracket can be attached to this side.
*4. Not available on the E3S-R12.

Standard Connector Models
E3S-R16, E3S-R17
E3S-R36

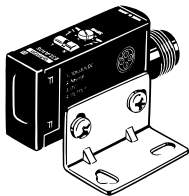

With Mounting Bracket Attached

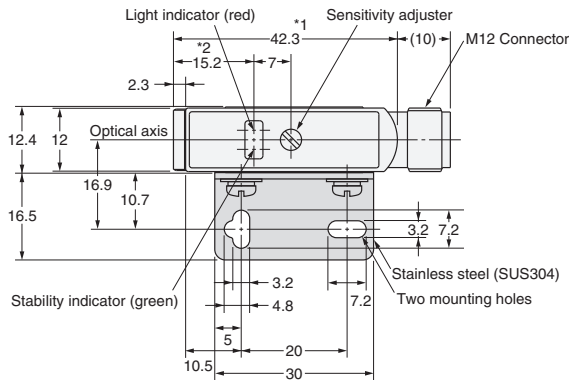

Mounting Holes

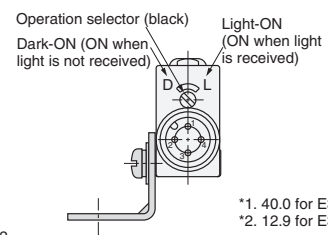
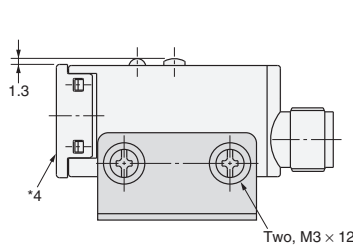
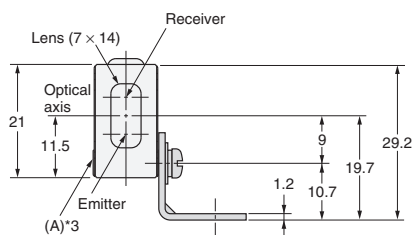
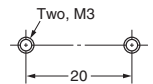

*1. 40.0 for E3S-R17.
*2. 12.9 for E3S-R17.

*3. The mounting bracket can be attached to this side.
*4. Not available on the E3S-R17.

Compact Vertical Models with Plastic Housing

Pre-wired Models
E3S-R61, E3S-R62
E3S-R81

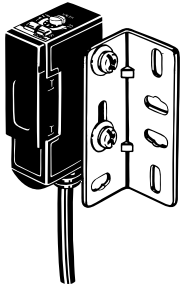

With Mounting Bracket Attached

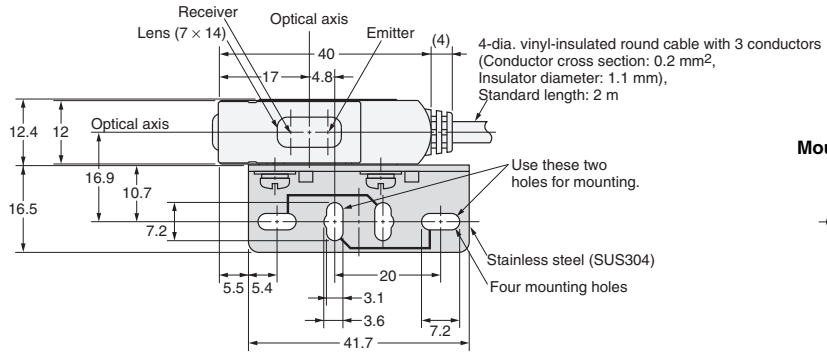

Mounting Holes

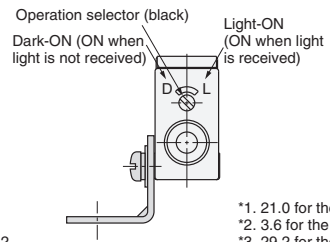
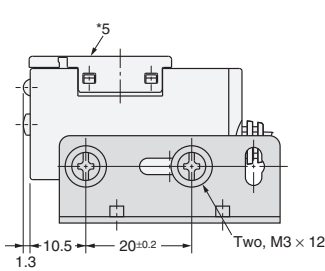
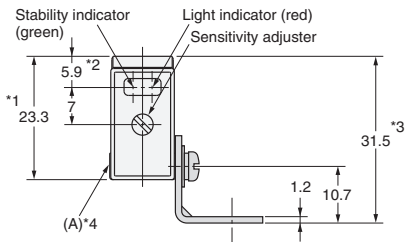
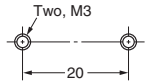

- *1. 21.0 for the E3S-R62.
- *2. 3.6 for the E3S-R62.
- *3. 29.2 for the E3S-R62.

- *4. The mounting bracket can be attached to this side.
- *5. Not available on the E3S-R62.

Standard Connector Models
E3S-R66, E3S-R67
E3S-R86

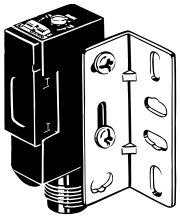

With Mounting Bracket Attached

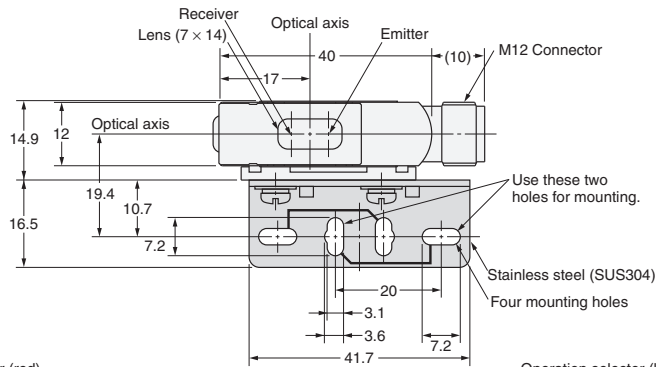

Mounting Holes

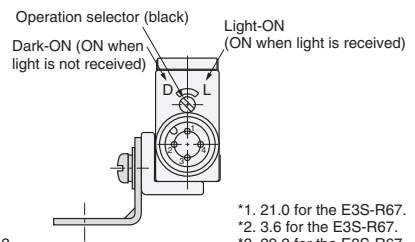
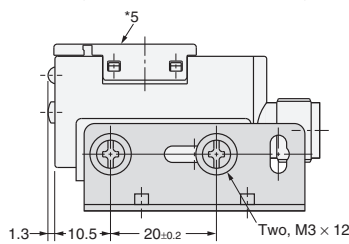
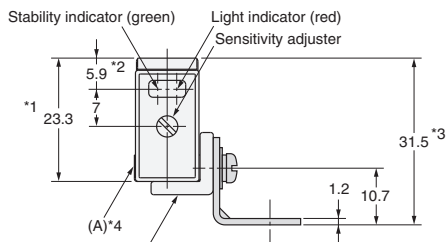
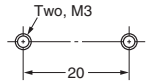

- *1. 21.0 for the E3S-R67.
- *2. 3.6 for the E3S-R67.
- *3. 29.2 for the E3S-R67.

E39-L60 Close Mounting Plate (provided)
(Attach the mounting plate or the plug cannot be connected.)

- *4. The mounting bracket can be attached to this side.
- *5. Not available on the E3S-R67.

Horizontal Models with Metal Housing

E3S-RS30E4
E3S-R1E4

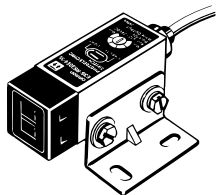

With Mounting Bracket Attached

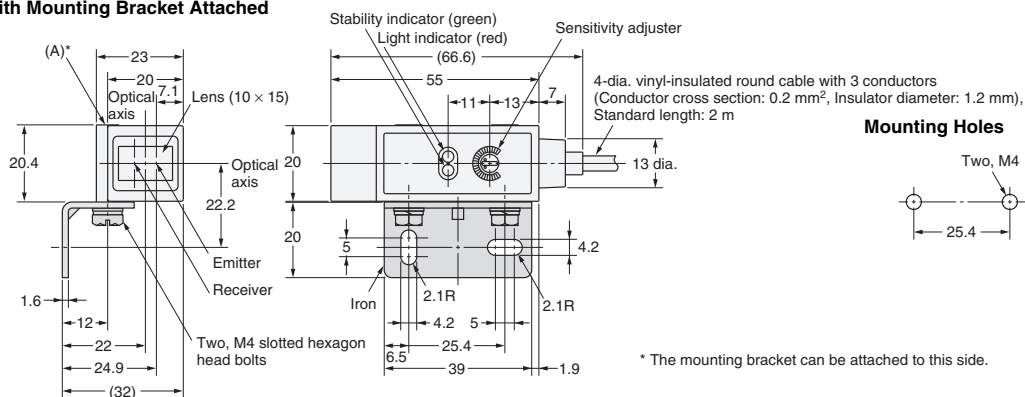

Vertical Models with Metal Housing

E3S-RS30E42
E3S-R1E42



With Mounting Bracket Attachment

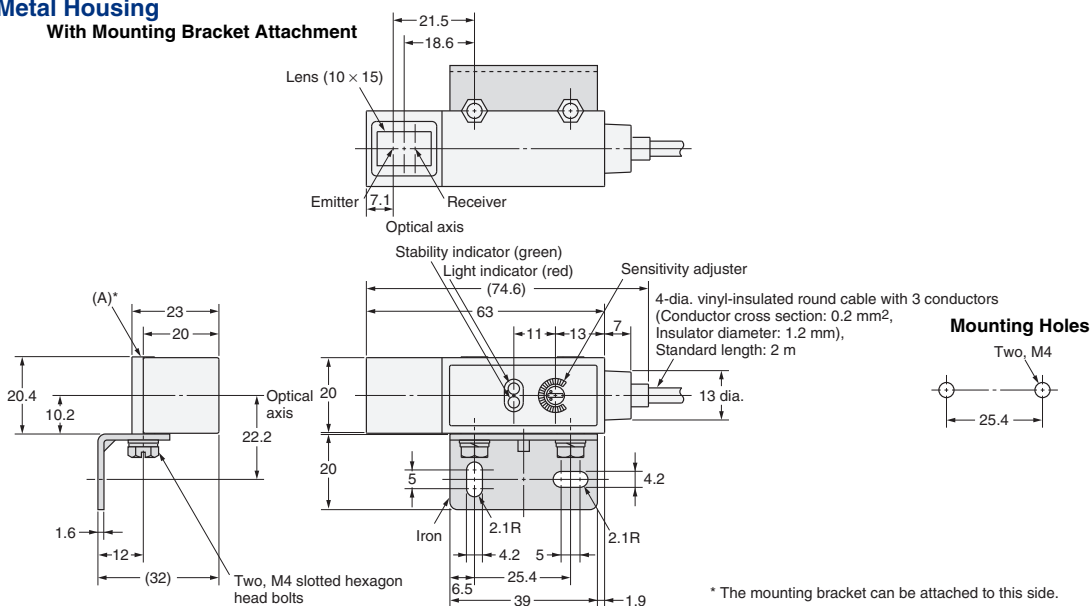

Accessories (Order Separately)

Sensitivity Adjuster

Refer to *E39-L/F39-L/E39-S/E39-R* for details.

Reflectors

Refer to *E39-L/F39-L/E39-S/E39-R* for details.

Mounting Brackets

Refer to *E39-L/F39-L/E39-S/E39-R* for details.

Close Mounting Plates

Refer to *E39-L/F39-L/E39-S/E39-R* for details.

Sensor I/O Connectors

Refer to *Introduction to Sensor I/O Connectors/Sensor Controllers* for details.

Terms and Conditions Agreement

Read and understand this catalog.

Please read and understand this catalog before purchasing the products. Please consult your OMRON representative if you have any questions or comments.

Warranties.

(a) Exclusive Warranty. Omron's exclusive warranty is that the Products will be free from defects in materials and workmanship for a period of twelve months from the date of sale by Omron (or such other period expressed in writing by Omron). Omron disclaims all other warranties, express or implied.

(b) Limitations. OMRON MAKES NO WARRANTY OR REPRESENTATION, EXPRESS OR IMPLIED, ABOUT NON-INFRINGEMENT, MERCHANTABILITY OR FITNESS FOR A PARTICULAR PURPOSE OF THE PRODUCTS. BUYER ACKNOWLEDGES THAT IT ALONE HAS DETERMINED THAT THE PRODUCTS WILL SUITABLY MEET THE REQUIREMENTS OF THEIR INTENDED USE.

Omron further disclaims all warranties and responsibility of any type for claims or expenses based on infringement by the Products or otherwise of any intellectual property right. (c) Buyer Remedy. Omron's sole obligation hereunder shall be, at Omron's election, to (i) replace (in the form originally shipped with Buyer responsible for labor charges for removal or replacement thereof) the non-complying Product, (ii) repair the non-complying Product, or (iii) repay or credit Buyer an amount equal to the purchase price of the non-complying Product; provided that in no event shall Omron be responsible for warranty, repair, indemnity or any other claims or expenses regarding the Products unless Omron's analysis confirms that the Products were properly handled, stored, installed and maintained and not subject to contamination, abuse, misuse or inappropriate modification. Return of any Products by Buyer must be approved in writing by Omron before shipment. Omron Companies shall not be liable for the suitability or unsuitability or the results from the use of Products in combination with any electrical or electronic components, circuits, system assemblies or any other materials or substances or environments. Any advice, recommendations or information given orally or in writing, are not to be construed as an amendment or addition to the above warranty.

See <http://www.omron.com/global/> or contact your Omron representative for published information.

Limitation on Liability: Etc.

OMRON COMPANIES SHALL NOT BE LIABLE FOR SPECIAL, INDIRECT, INCIDENTAL, OR CONSEQUENTIAL DAMAGES, LOSS OF PROFITS OR PRODUCTION OR COMMERCIAL LOSS IN ANY WAY CONNECTED WITH THE PRODUCTS, WHETHER SUCH CLAIM IS BASED IN CONTRACT, WARRANTY, NEGLIGENCE OR STRICT LIABILITY.

Further, in no event shall liability of Omron Companies exceed the individual price of the Product on which liability is asserted.

Suitability of Use.

Omron Companies shall not be responsible for conformity with any standards, codes or regulations which apply to the combination of the Product in the Buyer's application or use of the Product. At Buyer's request, Omron will provide applicable third party certification documents identifying ratings and limitations of use which apply to the Product. This information by itself is not sufficient for a complete determination of the suitability of the Product in combination with the end product, machine, system, or other application or use. Buyer shall be solely responsible for determining appropriateness of the particular Product with respect to Buyer's application, product or system. Buyer shall take application responsibility in all cases.

NEVER USE THE PRODUCT FOR AN APPLICATION INVOLVING SERIOUS RISK TO LIFE OR PROPERTY OR IN LARGE QUANTITIES WITHOUT ENSURING THAT THE SYSTEM AS A WHOLE HAS BEEN DESIGNED TO ADDRESS THE RISKS, AND THAT THE OMRON PRODUCT(S) IS PROPERLY RATED AND INSTALLED FOR THE INTENDED USE WITHIN THE OVERALL EQUIPMENT OR SYSTEM.

Programmable Products.

Omron Companies shall not be responsible for the user's programming of a programmable Product, or any consequence thereof.

Performance Data.

Data presented in Omron Company websites, catalogs and other materials is provided as a guide for the user in determining suitability and does not constitute a warranty. It may represent the result of Omron's test conditions, and the user must correlate it to actual application requirements. Actual performance is subject to the Omron's Warranty and Limitations of Liability.

Change in Specifications.

Product specifications and accessories may be changed at any time based on improvements and other reasons. It is our practice to change part numbers when published ratings or features are changed, or when significant construction changes are made. However, some specifications of the Product may be changed without any notice. When in doubt, special part numbers may be assigned to fix or establish key specifications for your application. Please consult with your Omron's representative at any time to confirm actual specifications of purchased Product.

Errors and Omissions.

Information presented by Omron Companies has been checked and is believed to be accurate; however, no responsibility is assumed for clerical, typographical or proofreading errors or omissions.