



Chipsmall Limited consists of a professional team with an average of over 10 year of expertise in the distribution of electronic components. Based in Hongkong, we have already established firm and mutual-benefit business relationships with customers from,Europe,America and south Asia,supplying obsolete and hard-to-find components to meet their specific needs.

With the principle of “Quality Parts,Customers Priority,Honest Operation,and Considerate Service”,our business mainly focus on the distribution of electronic components. Line cards we deal with include Microchip,ALPS,ROHM,Xilinx,Pulse,ON,Everlight and Freescale. Main products comprise IC,Modules,Potentiometer,IC Socket,Relay,Connector.Our parts cover such applications as commercial,industrial, and automotives areas.

We are looking forward to setting up business relationship with you and hope to provide you with the best service and solution. Let us make a better world for our industry!



Contact us

Tel: +86-755-8981 8866 Fax: +86-755-8427 6832

Email & Skype: info@chipsmall.com Web: www.chipsmall.com

Address: A1208, Overseas Decoration Building, #122 Zhenhua RD., Futian, Shenzhen, China



Simple Fiber Amplifier E3X-SD

The Standard for Fiber Amplifiers with Simple Operation and High Performance

- Operation so simple that essentially anyone can use the amplifier right way.
- Immediately determine operation and amount of light with a simple, bright display.
- General-purpose capabilities to simply handle a broad range of applications.



Ordering Information

Amplifier Units Digital Display and Direct Key Setting

Item	Appearance	Connection method	Ratings and Specifications	Model	
				NPN output	PNP output
Standard models		Pre-wired	---	E3X-SD11	E3X-SD41
		Wire-saving connector		E3X-SD6	E3X-SD8

Amplifier Unit Connectors (Order Separately)

Note: Stickers for Connectors are included as accessories.

Item	Appearance	Cable length	No. of conductors	Model
Master Connector		2 m	3	E3X-CN11
Slave Connector			1	E3X-CN12

Combining Amplifier Units and Connectors

(Basically, Amplifier Units and Connectors are sold separately)
Refer to the following tables when placing an order.

Type	Amplifier Units	
	NPN	PNP
Standard models	E3X-SD6	E3X-SD8

Applicable Connectors (Order Separately)	
Master Connector	Slave Connector
E3X-CN11 (3-wire)	E3X-CN12 (1-wire)

When Using 5 Amplifier Units

5 Amplifier Units	+	1 Master Connector + 4 Slave Connectors
-------------------	---	---

Sensor I/O Connectors (Order Separately)

Size	Cable specifications	Appearance	Cable type	Model	
M8	Standard cable	Straight connector	2 m	Four-conductor cable	XS3F-M421-402-A
			5 m		XS3F-M421-405-A
		L-shaped connector	2 m	XS3F-M422-402-A	
			5 m	XS3F-M422-405-A	

Accessories (Order Separately)

Mounting Brackets

Appearance	Applicable models	Model	Quantity
	E3X-SD□	E39-L143	1

End Plate

Appearance	Model	Quantity
	PFP-M	1

E3X-SD

Ratings and Specifications

Amplifier Units

Item	Type Model	Digital display and direct key setting
		Standard models
		E3X-SD□
Light source (wavelength)	Red LED (620 nm)	
Power supply voltage	12 to 24 VDC ±10%, ripple (p-p): 10% max.	
Current consumption	960 mW max. (Power supply: 24 V, Current consumption: 40 mA max.)	
Control output	Open-collector output (NPN or PNP) Load power supply: 26.4 V max., Load current: 50 mA max. (Residual voltage: 1.5 V max.) Light-ON/Dark-ON mode selector	
Response time	Operate or reset: 200 μs max.	
Sensitivity adjustment	UP/DOWN direct key setting, teaching	
Protection circuits	Power supply reverse polarity protection, output short-circuit protection, output reverse polarity protection	
Timer function	ON/OFF-delay timer: 10 ms (each fixed)	
Mutual interference prevention	Up to 5 Amplifiers (optically synchronized)	
Ambient illumination	Receiver side Incandescent lamp: 10,000 lux max. Sunlight: 20,000 lux max.	
Ambient temperature range	Operating: Groups of 1 to 3 Amplifiers: -25°C to 55°C Groups of 4 to 11 Amplifiers: -25°C to 50°C Groups of 12 to 16 Amplifiers: -25°C to 45°C Storage: -30°C to 70°C (with no icing or condensation)	
Ambient humidity range	Operating and storage: 35% to 85% (with no condensation)	
Insulation resistance	20 MΩ. min. (at 500 VDC)	
Dielectric strength	1,000 VAC at 50/60 Hz for 1 minute (*)	
Vibration resistance	Destruction: 10 to 55 Hz with a 1.5-mm double amplitude for 2 hrs each in X, Y and Z directions	
Shock resistance	Destruction: 500 m/s ² , for 3 times each in X, Y and Z directions	
Degree of protection	IEC 60529 IP50 (with Protective Cover attached)	
Connection method	Pre-wired (standard cable length: 2 m), or connector	
Weight (packed state)	Pre-wired model: Approx. 100 g, Model with connector: Approx. 55 g	
Material	Case	Polybutylene terephthalate (PBT)
	Cover	Polycarbonate
Accessories	Instruction manual	

* Models with connectors have a dielectric strength of 500 VAC.

Amplifier Unit Connectors

Item	Model	E3X-CN11
Rated current	2.5 A	
Rated voltage	50 V	
Contact resistance	20 mΩ max. (20 mVDC max., 100 mA max.) (The above figure is for connection to the Amplifier Unit and the adjacent Connector. It does not include the conductor resistance of the cable.)	
Number of insertions	Destruction: 50 times (for connection to the Amplifier Unit and the adjacent Connector)	
Material	Housing	Polybutylene terephthalate (PBT)
	Contact	Phosphor bronze/gold-plated nickel
Weight (packed state)	Approx. 55 g	

Fiber Unit Overview

No snagging, no breaking:
Right-angle (L-shaped) Models



Feature 1 | L-shaped Attachment

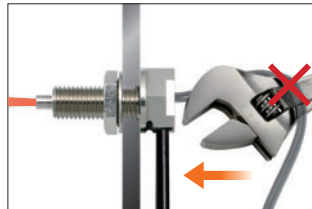

No snagging during maintenance. Fiber flexibility prevents breaking.

Feature 2 | New Head Shape

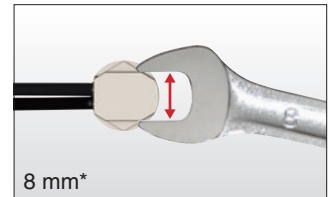
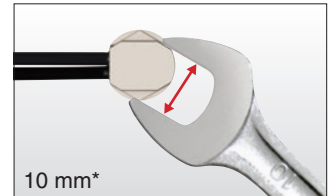

Convenient design accommodates two wrench sizes. Allows quick tightening.

*For M6 models.

Flat and flexible fiber models are easy to mount and will not break.

Reflective Fiber Units

Flat View E32-D15ZR

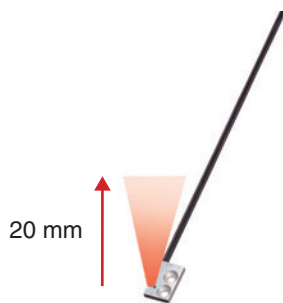

Size: 15 × 10 × 3 mm

Feature | No Breaking

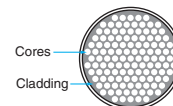
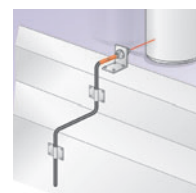
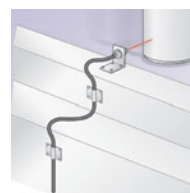

A large number of ultrafine cores are all surrounded by cladding. As a result, the fiber is flexible and can be bent without significantly reducing the light intensity. This helps solve problems, such as fiber being broken by getting caught on other objects.

Through-beam Fiber Units

Top View E32-T15XR

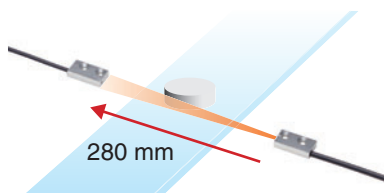

Size: 15 × 8 × 3 mm

Side View E32-T15YR

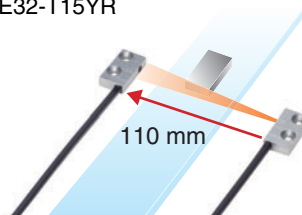

Flat View E32-T15ZR

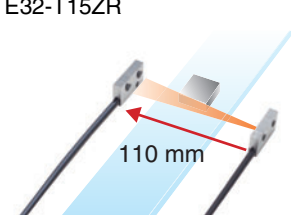

E3X-SD

Sensing Distance

Through-beam Models

(Unit: mm)

Type		Model	E3X-SD□
			Standard models
Standard models	Flexible (new standard)	E32-T11R/E32-T12R/E32-T15XR/E32-TC200BR (B4R)	280
		E32-T14LR/E32-T15YR/E32-T15ZR	110
		E32-T21R/E32-T22R/E32-T222R/E32-T25XR/ E32-TC200FR (F4R)	60
		E32-T24R/E32-T25YR/E32-T25ZR	30
	Standard	E32-TC200/E32-T12/E32-T15X/E32-TC200B (B4)	400
		E32-T14L/E32-T15Y/E32-T15Z	240
		E32-TC200A	360
		E32-TC200E/E32-T22/E32-T222/E32-T25X/E32-TC200F (F4)	100
		E32-T24/E32-T25Y/E32-T25Z	90
	Break resistant	E32-T11/E32-T12B/E32-T15XB	360
		E32-T21/E32-T221B/E32-T22B	100
		E32-T25XB	75
	Fluorine coating	E32-T11U	360
Special-beam models	Long distance, high power	E32-T17L	14000
		E32-TC200 + E39-F1	3000
		E32-T11R + E39-F1	2100
		E32-T11 + E39-F1	2000
		E32-T14	1800
		E32-T11L/E32-T12L	700
		E32-T11L + E39-F2	500
		E32-T11R + E39-F2	220
		E32-T11 + E39-F2	360
		E32-T21L/E32-T22L	200
	Ultracompact, ultrafine sleeve	E32-T223R	60
		E32-T33-S5	20
		E32-T333-S5	5
		E32-T334-S5	2.5
	Fine beam (narrow vision field)	E32-T22S	1000
		E32-T24S	700
	Area sensing	E32-T16PR	450
		E32-T16P	600
		E32-T16JR	390
		E32-T16J	520
		E32-T16WR	690
		E32-T16W	920
		E32-T16	1500
E32-M21		300	
Environment resistive models	Heat resistant	E32-T51	400
		E32-T54	130
		E32-T81R-S	180
		E32-T61-S + E39-F2	390
		E32-T61-S + E39-F1	3000
		E32-T84S-S	700
	E32-T61-S	300	
	Chemical resistant	E32-T11F	1050
		E32-T12F	1600
		E32-T14F	200
		E32-T51F	700
		E32-T81F-S	350
	Vacuum resistant	E32-T51V	100
		E32-T51V + E39-F1V	600
		E32-T54V	65
		E32-T54V + E39-F1V	390
		E32-T84SV	250

For information on Fiber Units, refer to the *E32 Series Fiber Sensor Best Selection* (Cat. No. E354).

Reflective Models

(Unit: mm)

Type		Model	E3X-SD□	
			Standard models	
Standard models	Flexible (new standard)	E32-D11R/E32-D12R/E32-D15XR/E32-DC200BR (B4R)	90	
		E32-D14LR	16	
		E32-D15YR/E32-D15ZR	20	
		E32-D211R/E32-D21R/E32-D22R/E32-D25XR/ E32-DC200FR (F4R)	15	
		E32-D24R	7	
		E32-D25YR/E32-D25ZR	4	
	Standard	E32-DC200/E32-D15X/E32-DC200B (B4)	150	
		E32-D12	120	
		E32-D14L	40	
		E32-D15Y/E32-D15Z	50	
		E32-D211/E32-DC200E/E32-D22/E32-D25X/ E32-DC200F (F4)	36	
		E32-D24	15	
		E32-D25Y/E32-D25Z	10	
	Break resistant	E32-D11/E32-D15XB	90	
		E32-D21B/E32-D221B	35	
		E32-D21/E32-D22B	15	
		E32-D25XB	25	
	Fluorine coating	E32-D11U	90	
	Special-beam models	Long distance, high power	E32-D16	40 to 400
			E32-D11L	200
E32-D21L/E32-D22L			50	
Ultracompact, ultrafine sleeve		E32-D33	10	
		E32-D331	1.5	
Coaxial, small spot		E32-CC200R	75	
		E32-CC200	150	
		E32-D32L	80	
		E32-C31/E32-D32	40	
		E32-C42 + E39-F3A	Spot diameter of 0.1 to 0.6 mm at 6 to 15 mm.	
		E32-D32 + E39-F3A	Spot diameter of 0.5 to 1 mm at 6 to 15 mm.	
		E32-C41 + E39-F3A-5	Spot diameter of 0.1 mm at 7 mm.	
		E32-C31 + E39-F3A-5	Spot diameter of 0.5 mm at 7 mm.	
		E32-C41 + E39-F3B	Spot diameter of 0.2 mm at 17 mm.	
		E32-C31 + E39-F3B	Spot diameter of 0.5 mm at 17 mm.	
E32-C31 + E39-F3C		Spot diameter of 4 mm max. at 0 to 20 mm.		
Area sensing		E32-D36P1	75	
Retro-reflective		E32-R21 + E39-R3 (provided)	10 to 250	
		E32-R16 + E39-R1 (provided)	150 to 1500	
Convergent-reflective		E32-L25/E32-L25A	3.3	
	E32-L24S	0 to 4		
	E32-L24L	2 to 6 (center 4)		
	E32-L25L	5.4 to 9 (center 7.2)		
	E32-L86	4 to 10		
E32-L16	0 to 15			
Environment resistive models	Heat resistant	E32-D51	120	
		E32-D81R/E32-D61	45	
		E32-D73	30	
	Chemical resistant	E32-D12F	50	
		E32-D14F	20	

For information on Fiber Units, refer to the *E32 Series Fiber Sensor Best Selection* (Cat. No. E354).

E3X-SD

I/O Circuit Diagrams

Output form	Model	Output transistor operation mode	Timing charts	Operation selector	Output circuit
NPN Output	E3X-SD11 E3X-SD6	Light-ON		LIGHT ON (L-ON)	<p>• M8 Connector Pin Arrangement </p> <p>Note: Pin 2 is not used.</p>
		Dark-ON		DARK ON (D-ON)	<p>• M8 Connector Pin Arrangement </p> <p>Note: Pin 2 is not used.</p>
PNP Output	E3X-SD41 E3X-SD8	Light-ON		LIGHT ON (L-ON)	<p>• M8 Connector Pin Arrangement </p> <p>Note: Pin 2 is not used.</p>
		Dark-ON		DARK ON (D-ON)	<p>• M8 Connector Pin Arrangement </p> <p>Note: Pin 2 is not used.</p>

Note: Timing Charts for Timer Settings (T: Set Time)

ON delay	OFF delay

Plug (Sensor I/O Connector)

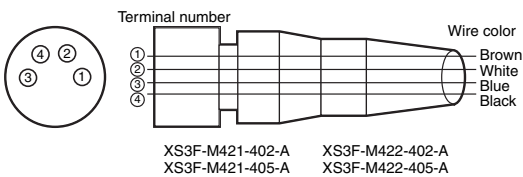

Classification	Wire color	Connection pin	Application
DC	Brown	1	Power supply (+V)
	White	2	---
	Blue	3	Power supply (0 V)
	Black	4	Output

Note: Pin 2 is not used.

Nomenclature

Amplifier Units

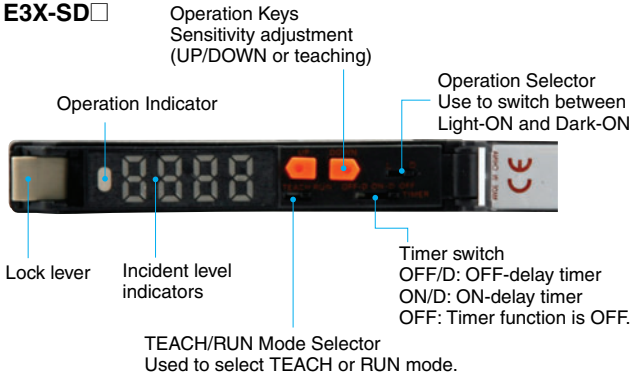

Safety Precautions

⚠ WARNING

This product is not designed or rated for ensuring safety of persons either directly or indirectly.

Do not use it for such purposes.

⚠ Caution

Do not exceed the rated voltage. Excess voltage may result in malfunction or fire.

Do not use an AC power supply. Using an AC power supply may result in rupturing.

High-temperature environments may result in burn injury.

Precautions for Safe Use

- The following precautions must be observed to ensure safety.
1. Do not use the product in locations where flammable or explosive gas is present.
 2. Do not use the product in locations subject to splashing water, oil, or chemicals, or in locations subject to steam.
 3. Do not attempt to disassemble, repair, or modify the product.
 4. Do not apply voltage or current in excess of the rated ranges.
 5. Do not use the product in atmospheres or environments that exceed product ratings.
 6. Do not wire the product incorrectly, such as using incorrect power supply polarity.
 7. Connect the load properly.
 8. Do not short-circuit both ends of the load.
 9. Do not use the product if the case is damaged.
 10. When disposing of the product, dispose of it as industrial waste.
 11. Do not use the product in locations subject to direct sunlight.
 12. The surface temperature of the product may rise as a result of the ambient temperature, power supply, or other usage conditions. Use caution when performing maintenance and washing. Failure to do so may result in burn injury.

Precautions for Correct Use

Do not use the product in atmospheres or environments that exceed product ratings.

Amplifier Units

● Designing

Communications Hole

The hole on the side of the Amplifier Unit is a communications hole for preventing mutual interference when Amplifier Units are mounted side-by-side. The E3X-MC11 Mobile Console (order separately) cannot be used.

If an excessive amount of light is received via the Sensor, the mutual interference prevention function may not work. In this case, make the appropriate adjustments using the sensitivity adjuster.

The mutual interference prevention function will not operate when the E3X-SD/NA is used side-by-side with E3X-DA-N models.

● Mounting

DIN Track Mounting/Removal

Mounting Amplifier Units

1. Mount the Amplifier Units one at a time onto the DIN track.

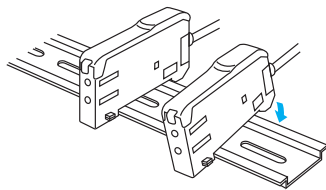

2. Slide the Amplifier Units together, line up the clips, and press the Amplifier Units together until they click into place.

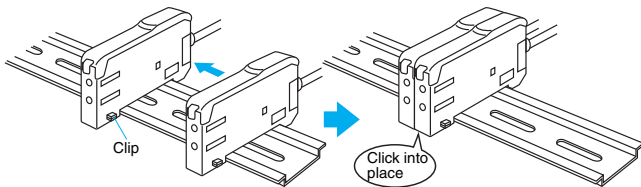

Removing Amplifier Units

Slide Amplifier Units away from each other, and remove from the DIN track one at a time. (Do not attempt to remove Amplifier Units from the DIN track without separating them first.)

- Note 1.** The specifications for ambient temperature will vary according to the number of Amplifier Units used together. For details, refer to *Ratings and Specifications*.
- 2.** Always turn OFF the power supply before mounting or removing Amplifier Units.

Fiber Connection and Disconnection

The E3X Amplifier Unit has a lock lever. Connect or disconnect the fibers to or from the E3X Amplifier Unit using the following procedures:

1. Connection

Open the Protective Cover, insert the fibers according to the fiber insertion marks on the side of the Amplifier Unit, and lower the lock lever.

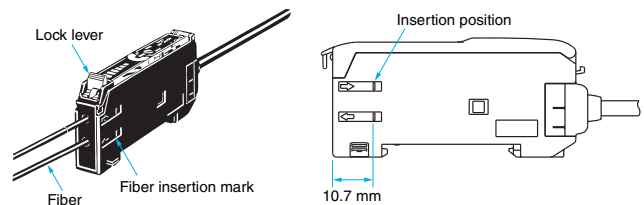

2. Disconnection

Remove the Protective Cover and raise the lock lever to pull out the fiber.

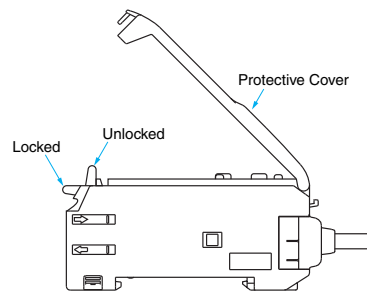

Note: To maintain the fiber properties, confirm that the lock is released before removing the fiber.

3. Precautions for Fiber Connection/Disconnection

Be sure to lock or unlock the lock lever within an ambient temperature range between -10°C and 40°C .

● Operating Environment

Ambient Conditions

If dust or dirt adhere to the hole for optical communications, it may prevent normal communications. Be sure to remove any dust or dirt before using the Units.

● Other

Protective Cover

Be sure to mount the Protective Cover before use.

Amplifier Units with Connectors

● Mounting

Mounting Connectors

- 1. Insert the Master or Slave Connector into the Amplifier Unit until it clicks into place.

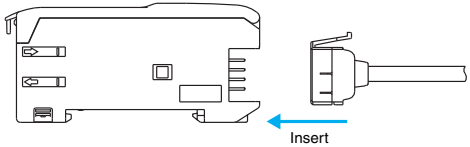

- 2. Join Amplifier Units together as required after all the Master and Slave Connectors have been inserted.
- 3. Attach the stickers (provided as accessories) to the sides of Master and Slave Connectors that are not connected to other Connectors.

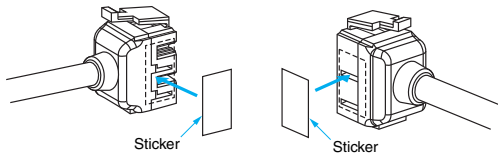

Note: Attach the stickers to the sides with grooves.

Removing Connectors

- 1. Slide the slave Amplifier Unit for which the Connector is to be removed away from the rest of the group.
- 2. After the Amplifier Unit has been separated, press down on the lever on the Connector and remove it. (Do not attempt to remove Connectors without separating them from other Amplifier Units first.)

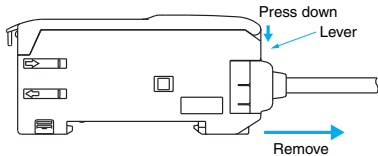

Mounting End Plate (PFP-M)

Depending on how it is mounted, an Amplifier Unit may move during operation. In this case, use an End Plate. Before mounting an End Plate, remove the clip from the master Amplifier Unit using a nipper or similar tool.

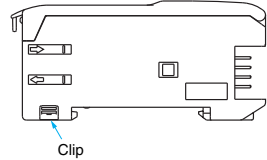

The clip can also be removed using the following mechanism, which is incorporated in the construction of the section underneath the clip.

- 1. Insert the clip to be removed into the slit underneath the clip on another Amplifier Unit.

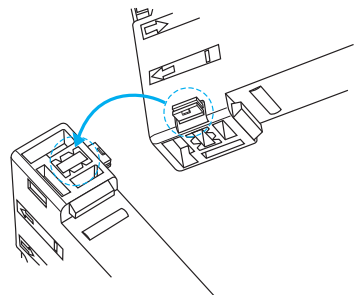

- 2. Remove the clip by rotating the Amplifier Unit.

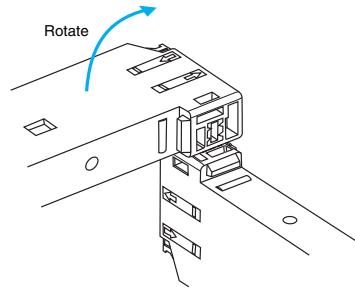

Pull Strengths for Connectors (Including Cables)

E3X-CN11: 30 N max.
E3X-CN12: 12 N max.

E3X-SD

Dimensions

(Unit: mm)

Amplifier Units

Amplifier Units with Cables

E3X-SD11
E3X-SD41

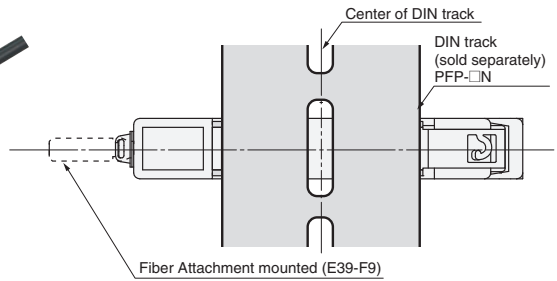
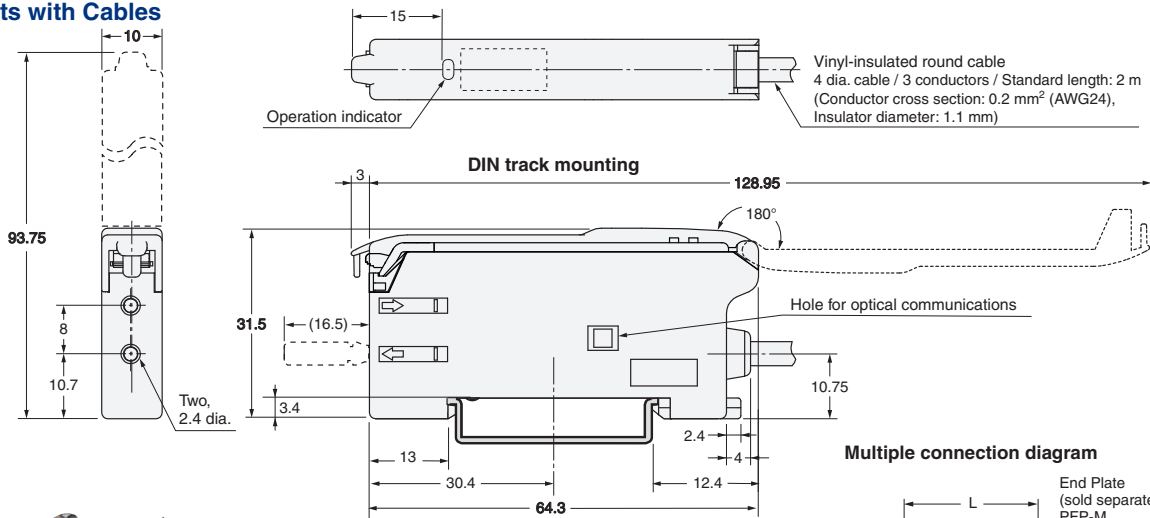

Multiple connection diagram

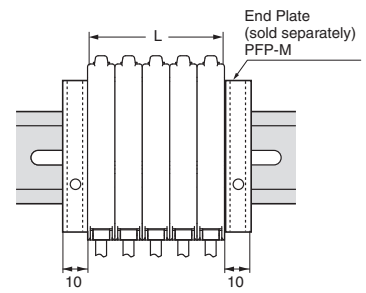

The number of expansion	L (mm)
1	10
2	20
3	30
4	40
5	50
6	60
7	70
8	80
9	90
10	100

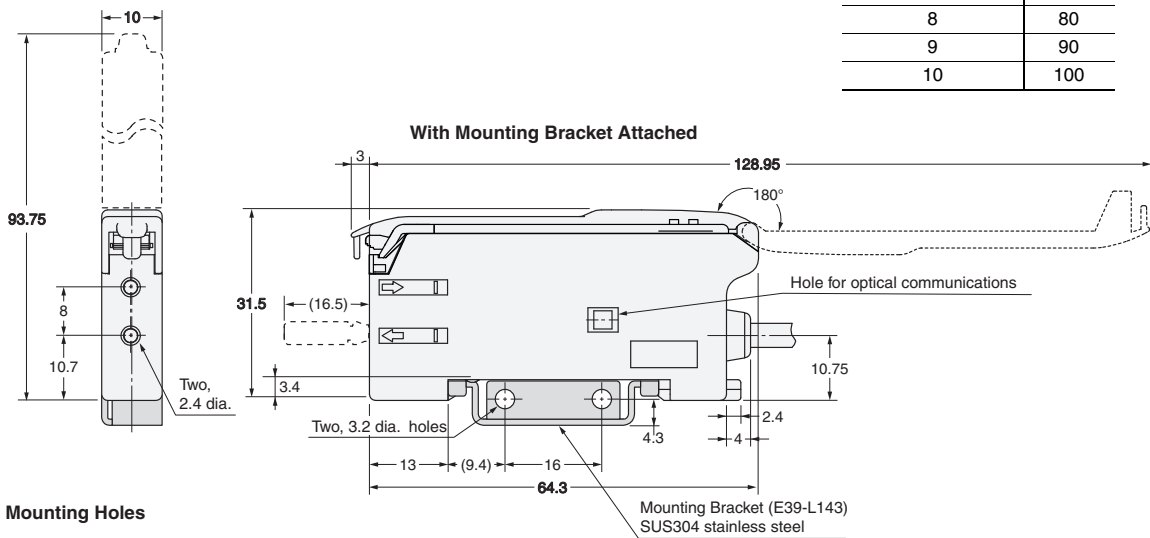

Mounting Holes

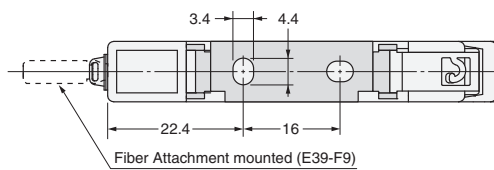
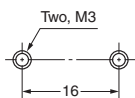

Amplifier Units with Connectors

E3X-SD6
E3X-SD8

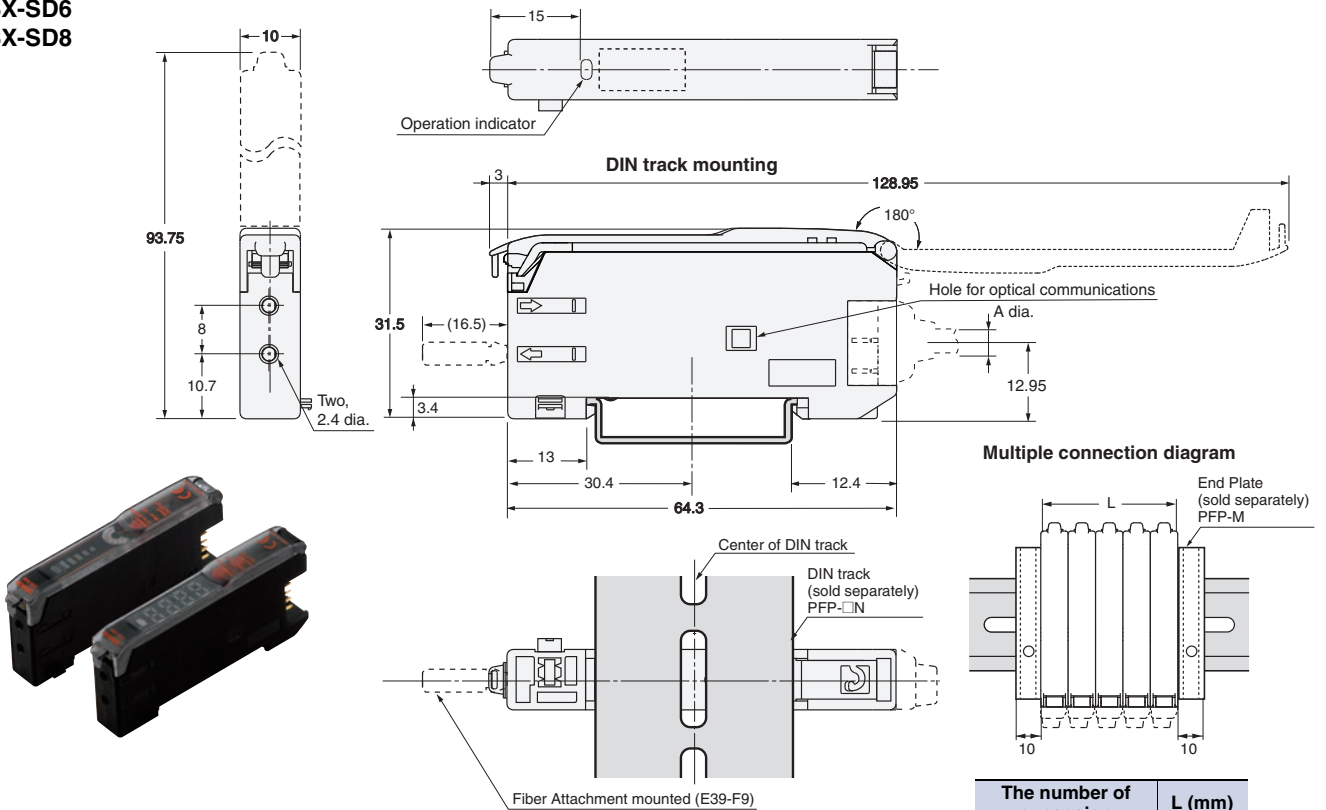

* Cable Diameters

E3X-CN11 (3 conductors)	4.0-mm dia.
E3X-CN12 (1 conductor)	2.6-mm dia.

The number of expansion	L (mm)
1	10
2	20
3	30
4	40
5	50
6	60
7	70
8	80
9	90
10	100

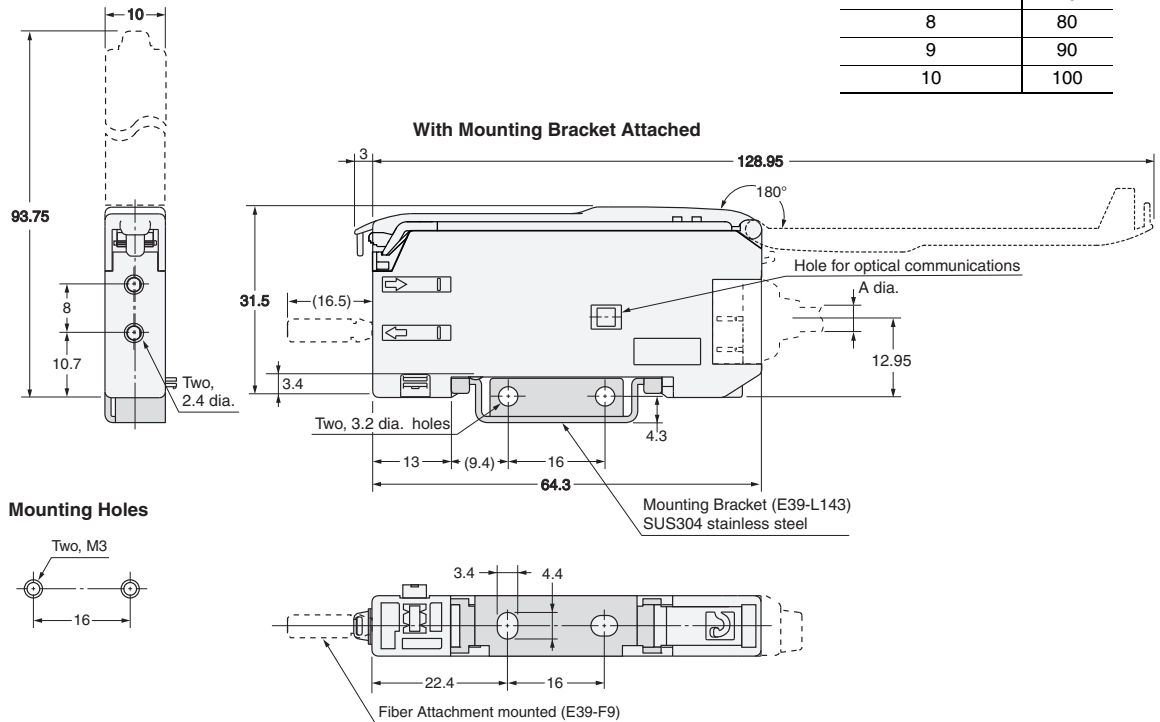

E3X-SD

Amplifier Unit Connectors

Master Connector E3X-CN11

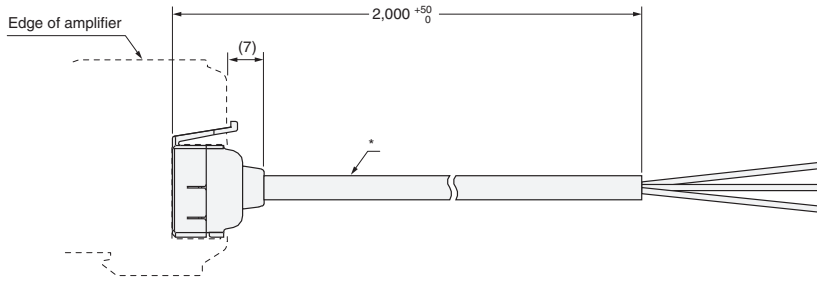

* E3X-CN11: **4 dia. cable / 3 conductors** / Standard length: 2 m (Conductor cross section: 0.2 mm² (AWG24), Insulator diameter: 1.1 mm)

Slave Connector E3X-CN12

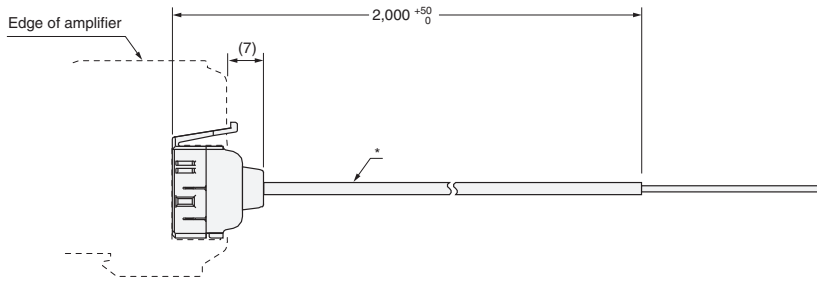

* E3X-CN12: **2.6 dia. cable / 1 conductor** / Standard length: 2 m (Conductor cross section: 0.2 mm² (AWG24), Insulator diameter: 1.1 mm)

Accessories (Order Separately)

Mounting Brackets E39-L143

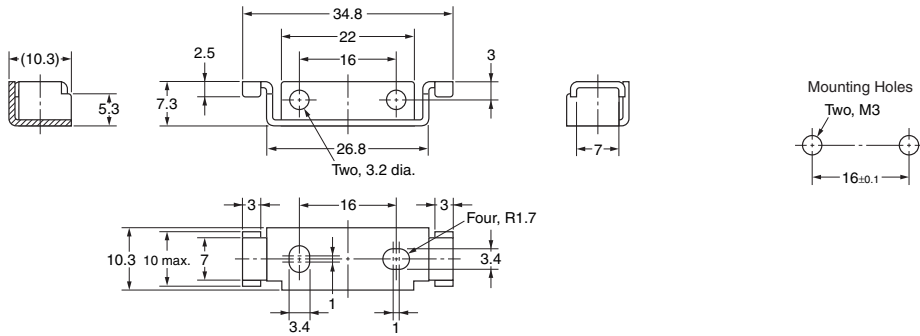
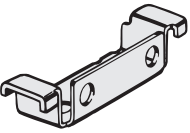

Material: Stainless steel (SUS304)

End Plates PFP-M

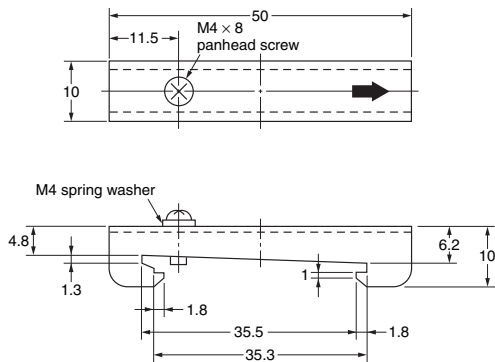
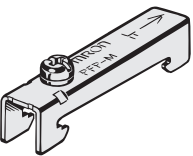

For information on Fiber Units, refer to the *E32 Series Fiber Sensor Best Selection* (Cat. No. E353).

Operating Procedure

E3X-SD□

1 Displays

A 7-segment display showing excess gain is provided in addition to the orange operation indicator. Use these when adjusting the light axis and setting the sensitivity at setup.

Display/indicator status (for L/ON)	Excess gain	Description
	999% (10 times)	110% min. Stable incident light
	100%	90% to 110% Unstable incident light or Unstable interrupted light
	0%	90% max. Stable interrupted light

2 Sensitivity Setting

The sensitivity can be set with the UP and DOWN Keys similar to using an adjuster knob. The sensitivity can also be easily set by using the following three teaching functions.

2-1. Maximum Sensitivity Setting

The sensitivity can be set to the maximum. This is the optimal setting for resistance against the effects of dust.

Operation description	Switch/Key	Display
Set the TEACH/RUN selector switch to TEACH.	TEACH RUN [TEACH]	0 t E c h ◀▶ 0 103P
Press the UP Key for 3 s min.	UP [UP]	0 FULL
Set the TEACH/RUN selector switch to RUN (start of measurement).	TEACH RUN [RUN]	0 r u n ▶ 0 103P

2-2. Teaching with/without a Workpiece

Two points (one with the workpiece and the other without) are detected, and the operating level is set to the midpoint.

Operation description	Switch/Key	Display
Set the TEACH/RUN selector switch to TEACH.	TEACH RUN [TEACH]	0 t E c h ◀▶ 0 103P
Press the UP Key with the workpiece present.	UP [UP]	0 - - - -
Press the UP Key with the workpiece not present.	UP [UP]	0 2P n t
Set the TEACH/RUN selector switch to RUN (start of measurement).	TEACH RUN [RUN]	0 r u n ▶ 0 103P

2-3. Automatic Teaching

Changes within a time are detected, and the operating level is set to the midpoint between the maximum and the minimum values of the changes. This setting is optimal for when the workpieces cannot be stopped.

Operation description	Switch/Key	Display
Set the TEACH/RUN selector switch to TEACH.	TEACH RUN [TEACH]	0 t E c h ◀▶ 0 103P
Press the UP Key.	UP [UP]	0 - - - -
Hold down the UP Key during detection. Let the workpiece pass while the key is held down.	UP [UP]	0 A U t o
Set the TEACH/RUN selector switch to RUN (start of measurement).	TEACH RUN [RUN]	0 r u n ▶ 0 103P

READ AND UNDERSTAND THIS DOCUMENT

Please read and understand this document before using the products. Please consult your OMRON representative if you have any questions or comments.

WARRANTY

OMRON's exclusive warranty is that the products are free from defects in materials and workmanship for a period of one year (or other period if specified) from date of sale by OMRON.

OMRON MAKES NO WARRANTY OR REPRESENTATION, EXPRESS OR IMPLIED, REGARDING NON-INFRINGEMENT, MERCHANTABILITY, OR FITNESS FOR PARTICULAR PURPOSE OF THE PRODUCTS. ANY BUYER OR USER ACKNOWLEDGES THAT THE BUYER OR USER ALONE HAS DETERMINED THAT THE PRODUCTS WILL SUITABLY MEET THE REQUIREMENTS OF THEIR INTENDED USE. OMRON DISCLAIMS ALL OTHER WARRANTIES, EXPRESS OR IMPLIED.

LIMITATIONS OF LIABILITY

OMRON SHALL NOT BE RESPONSIBLE FOR SPECIAL, INDIRECT, OR CONSEQUENTIAL DAMAGES, LOSS OF PROFITS OR COMMERCIAL LOSS IN ANY WAY CONNECTED WITH THE PRODUCTS, WHETHER SUCH CLAIM IS BASED ON CONTRACT, WARRANTY, NEGLIGENCE, OR STRICT LIABILITY.

In no event shall responsibility of OMRON for any act exceed the individual price of the product on which liability is asserted.

IN NO EVENT SHALL OMRON BE RESPONSIBLE FOR WARRANTY, REPAIR, OR OTHER CLAIMS REGARDING THE PRODUCTS UNLESS OMRON'S ANALYSIS CONFIRMS THAT THE PRODUCTS WERE PROPERLY HANDLED, STORED, INSTALLED, AND MAINTAINED AND NOT SUBJECT TO CONTAMINATION, ABUSE, MISUSE, OR INAPPROPRIATE MODIFICATION OR REPAIR.

SUITABILITY FOR USE

THE PRODUCTS CONTAINED IN THIS DOCUMENT ARE NOT SAFETY RATED. THEY ARE NOT DESIGNED OR RATED FOR ENSURING SAFETY OF PERSONS, AND SHOULD NOT BE RELIED UPON AS A SAFETY COMPONENT OR PROTECTIVE DEVICE FOR SUCH PURPOSES. Please refer to separate catalogs for OMRON's safety rated products.

OMRON shall not be responsible for conformity with any standards, codes, or regulations that apply to the combination of products in the customer's application or use of the product.

At the customer's request, OMRON will provide applicable third party certification documents identifying ratings and limitations of use that apply to the products. This information by itself is not sufficient for a complete determination of the suitability of the products in combination with the end product, machine, system, or other application or use.

The following are some examples of applications for which particular attention must be given. This is not intended to be an exhaustive list of all possible uses of the products, nor is it intended to imply that the uses listed may be suitable for the products:

- Outdoor use, uses involving potential chemical contamination or electrical interference, or conditions or uses not described in this document.
- Nuclear energy control systems, combustion systems, railroad systems, aviation systems, medical equipment, amusement machines, vehicles, safety equipment, and installations subject to separate industry or government regulations.
- Systems, machines, and equipment that could present a risk to life or property.

Please know and observe all prohibitions of use applicable to the products.

NEVER USE THE PRODUCTS FOR AN APPLICATION INVOLVING SERIOUS RISK TO LIFE OR PROPERTY WITHOUT ENSURING THAT THE SYSTEM AS A WHOLE HAS BEEN DESIGNED TO ADDRESS THE RISKS, AND THAT THE OMRON PRODUCT IS PROPERLY RATED AND INSTALLED FOR THE INTENDED USE WITHIN THE OVERALL EQUIPMENT OR SYSTEM.

PERFORMANCE DATA

Performance data given in this document is provided as a guide for the user in determining suitability and does not constitute a warranty. It may represent the result of OMRON's test conditions, and the users must correlate it to actual application requirements. Actual performance is subject to the OMRON Warranty and Limitations of Liability.

CHANGE IN SPECIFICATIONS

Product specifications and accessories may be changed at any time based on improvements and other reasons.

It is our practice to change model numbers when published ratings or features are changed, or when significant construction changes are made. However, some specifications of the product may be changed without any notice. When in doubt, special model numbers may be assigned to fix or establish key specifications for your application on your request. Please consult with your OMRON representative at any time to confirm actual specifications of purchased products.

DIMENSIONS AND WEIGHTS

Dimensions and weights are nominal and are not to be used for manufacturing purposes, even when tolerances are shown.

ERRORS AND OMISSIONS

The information in this document has been carefully checked and is believed to be accurate; however, no responsibility is assumed for clerical, typographical, or proofreading errors, or omissions.

PROGRAMMABLE PRODUCTS

OMRON shall not be responsible for the user's programming of a programmable product, or any consequence thereof.

COPYRIGHT AND COPY PERMISSION

This document shall not be copied for sales or promotions without permission.

This document is protected by copyright and is intended solely for use in conjunction with the product. Please notify us before copying or reproducing this document in any manner, for any other purpose. If copying or transmitting this document to another, please copy or transmit it in its entirety.

This document provides information mainly for selecting suitable models. Please read the Instruction sheet carefully for information that the user must understand and accept before purchase, including information on warranty, limitations of liability, and precautions.

OMRON Corporation Industrial Automation Company

Tokyo, JAPAN

Contact: www.ia.omron.com

Regional Headquarters

OMRON EUROPE B.V.

Sensor Business Unit

Carl-Benz-Str. 4, D-71154 Nufringen, Germany
Tel: (49) 7032-811-0/Fax: (49) 7032-811-199

OMRON ASIA PACIFIC PTE. LTD.

No. 438A Alexandra Road # 05-05/08 (Lobby 2),
Alexandra Technopark,
Singapore 119967
Tel: (65) 6835-3011/Fax: (65) 6835-2711

OMRON ELECTRONICS LLC

One Commerce Drive Schaumburg,
IL 60173-5302 U.S.A.
Tel: (1) 847-843-7900/Fax: (1) 847-843-7787

OMRON (CHINA) CO., LTD.

Room 2211, Bank of China Tower,
200 Yin Cheng Zhong Road,
PuDong New Area, Shanghai, 200120, China
Tel: (86) 21-5037-2222/Fax: (86) 21-5037-2200

Authorized Distributor:

© OMRON Corporation 2009 All Rights Reserved.
In the interest of product improvement,
specifications are subject to change without notice.
CSM_2_1_0114

Cat. No. E388-E1-02

0410