



Chipsmall Limited consists of a professional team with an average of over 10 year of expertise in the distribution of electronic components. Based in Hongkong, we have already established firm and mutual-benefit business relationships with customers from,Europe,America and south Asia,supplying obsolete and hard-to-find components to meet their specific needs.

With the principle of "Quality Parts,Customers Priority,Honest Operation,and Considerate Service",our business mainly focus on the distribution of electronic components. Line cards we deal with include Microchip,ALPS,ROHM,Xilinx,Pulse,ON,Everlight and Freescale. Main products comprise IC,Modules,Potentiometer,IC Socket,Relay,Connector.Our parts cover such applications as commercial,industrial, and automotives areas.

We are looking forward to setting up business relationship with you and hope to provide you with the best service and solution. Let us make a better world for our industry!



## Contact us

Tel: +86-755-8981 8866 Fax: +86-755-8427 6832

Email & Skype: info@chipsmall.com Web: www.chipsmall.com

Address: A1208, Overseas Decoration Building, #122 Zhenhua RD., Futian, Shenzhen, China



### 1/16 DIN Sized, Analog-Set Controller Features Dual Scale Dial

- Proportional-derivative (PD) control or ON/OFF control models
- Front panel offset adjustment on PD controllers
- Choose contact or voltage outputs
- Type J or K thermocouples, platinum RTD and thermistor input models
- Fits standard 8-pin round sockets
- Panel mounting hardware included
- Sockets, protective cover, and other accessories may be ordered separately



## Ordering Information

### ■ TEMPERATURE CONTROLLERS

Add the temperature range and supply voltage to the part number when you order. The minimum scale division is in parentheses. For example, **E5C2-R20K-32° to 392°F-AC120**.

Control type	Output type	Input type (specify temperature range from choices below)	
		Thermocouple type K	Thermocouple type J
ON/OFF	Contact	<b>E5C2-R20K</b>	<b>E5C2-R20J</b>
	Voltage	<b>E5C2-Q20K</b>	<b>E5C2-Q20J</b>
PD	Contact	<b>E5C2-R40K</b>	<b>E5C2-R40J</b>
	Voltage	<b>E5C2-Q40K</b>	<b>E5C2-Q40J</b>
Temperature ranges		32° to 392°F (10)/0° to 200°C (5) 32° to 572°F (20)/0° to 300°C (10) 32° to 752°F (20)/0° to 400°C (10) 32° to 1112°F (50)/0° to 600°C (20) 32° to 1472°F (50)/0° to 800°C (20) 32° to 1832°F (50)/0° to 1000°C (25) 32° to 2192°F (50)/0° to 1200°C (25)	32° to 392°F (10)/0° to 200°C (5) 32° to 572°F (20)/0° to 300°C (10) 32° to 752°F (20)/0° to 400°C (10)
Supply voltages		110/120 VAC, 50/60 Hz or 220/240 VAC, 50/60 Hz	

Control type	Output type	Input type (specify the temperature range from choices below)	
		Platinum RTD	Thermistor
ON/OFF	Contact	<b>E5C2-R20P-DIN</b>	<b>E5C2-R20G</b>
	Voltage	<b>E5C2-Q20P-DIN</b>	<b>E5C2-Q20G</b>
PD	Contact	<b>E5C2-R40P-DIN</b>	—
	Voltage	<b>E5C2-Q40P-DIN</b>	—
Temperature ranges		-58° to 122°F (5)/-50° to 50°C (2) -4° to 176°F (5)/-20° to 80°C (2) 32° to 122°F (2)/0° to 50°C (1) 32° to 212°F (5)/0° to 100°C (2) 32° to 392°F (10)/0° to 200°C (5) 32° to 572°F (20)/0° to 300°C (10) 32° to 752°F (20)/0° to 400°C (10)	-58° to 122°F (5)/-50° to 50°C (2) 32° to 212°F (5)/0° to 100°C (2) 122° to 302°F (5)/50° to 150°C (2) 212° to 392°F (5)/100° to 200°C (2) 302° to 572°F (10)/150° to 300°C (5)
Supply voltages		110/120 VAC, 50/60 Hz or 220/240 VAC, 50/60 Hz, or 24 VDC	

## ■ ACCESSORIES

Description		Part number
Sockets	Bottom surface or track mounting, top screw terminals	P2CF-08
	Back mounting, for use with Y92F-30 mounting adapter supplied, bottom screw terminals	P3G-08
	Back mounting plug type, for use with Y92F-30 mounting adapter supplied	US08
Protective cover	Hard plastic cover protects against accidental resetting.	Y92A-48B
Mounting track	DIN rail, 50 cm (1.64 ft) length	PFP-50N
	DIN rail, 1 m (3.28 ft) length	PFP-100N
	End plate	PFP-M
	Spacer	PFP-S

## ■ REPLACEMENT PART

Description	Part number
Panel mounting bracket; one supplied with each controller	Y92F-30

## Specifications

Part number	E5C2-□□□K	E5C2-□□□J	E5C2-□□□P-DIN	E5C2-□□□G
Sensor input types	Thermocouple type K	Thermocouple type J	Platinum RTD	Thermistor
Supply voltage	100/120 VAC, 50/60 Hz or 220/240 VAC, 50/60 Hz			
Operating voltage	90 to 110% of rated supply voltage			
Power consumption	Approx. 2 VA			
Control output	Number	One output, built in		
	Type	Relay	SPDT, 3 A, 250 VAC (resistive load), switching capacity of 330 VA	
		Voltage	5 VDC, 10 mA with short-circuit protection	
	Hysteresis	0.5% max. of full scale (fixed)		
	Service life	100,000 electrical operations minimum for relay output 10 million mechanical operations minimum for relay output		
Alarm output	Not available			
Setting accuracy	±2% maximum of full scale			
Control modes	Type	ON/OFF (E5C2-□20□) or PD (E5C2-□40□)		
	Proportional band	3% of full scale (fixed)		
	Reset	3% minimum of full scale (variable); front panel potentiometer adjustment		
	Control period	Approx. 20 seconds, where ratio of ON to OFF is 1:1		
Memory protection	Not available			
Indicators	Operation Indicator (red LED)			
Materials	Plastic case			
Mounting	Fits 1/16 DIN panel cutouts; includes panel mounting adapter Y92F-30			
Connections	Terminals for standard 8-pin round connectors			
Weight	Approx. 200 g (7 oz.)			
Enclosure ratings	Front panel	IEC IP40, NEMA 4 with optional cover Y92A-48N		
	Housing	IEC IP20		
	Terminals	IEC IP00		
Approvals	UL	Recognized, File No. E68481, approved control output rating 1.5 A, 250 VAC		
	CSA	Certified, File No. LR59623, approved control output rating 1.5 A, 250 VAC		
	Other	SEV, File No. D4.11/634		
Ambient temperature	Use	-10° to 55°C (14° to 131°F)		
	Storage	-25° to 65°C (-13° to 149°F)		
Humidity	35 to 85% RH			
Insulation resistance	20 MΩ minimum at 500 VDC			
Dielectric strength	2,000 VAC, 50/60 Hz for 1 minute			
Vibration	Mechanical	10 to 55 Hz 0.75 mm (0.03 in) in X, Y, and Z directions for 2 hours each		
	Malfunction	2 to 55 Hz, 2 G, in X, Y, and Z directions for 10 minutes each		
Shock	Mechanical	300 m/s <sup>2</sup> in 6 directions, 3 times each		
	Malfunction	200 m/s <sup>2</sup> in 6 directions, 3 times each		

# Dimensions

Unit: mm (inch)

## ■ TEMPERATURE CONTROLLER

### E5C2

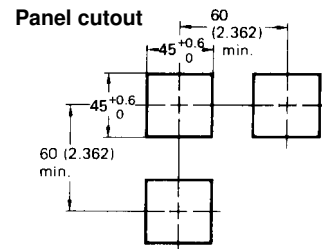
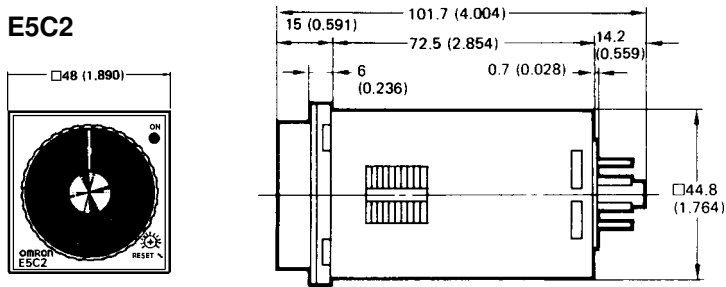

### E5C2 Temperature Controller Mounted in Y92F-30 Panel Mounting Adapter (supplied)

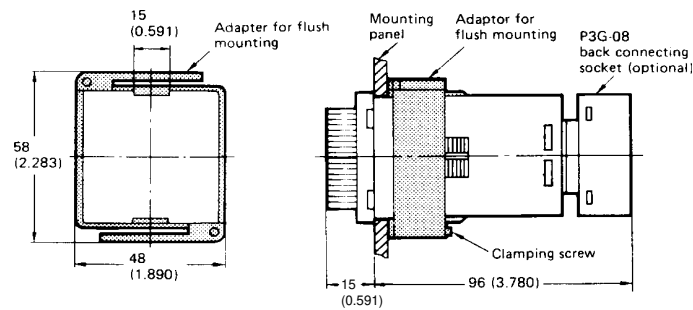

## ■ SOCKETS

### P2CF-08 Bottom surface or track mounting socket

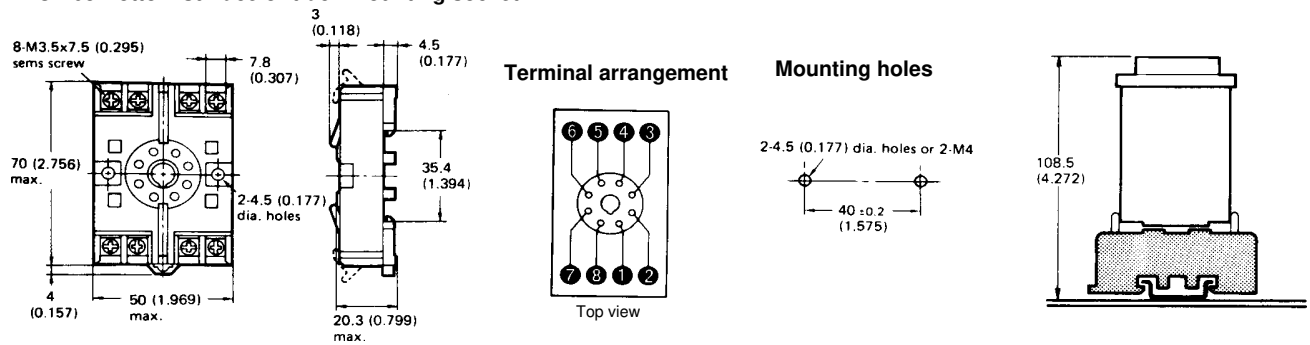

### P3G-08 Back mounting socket

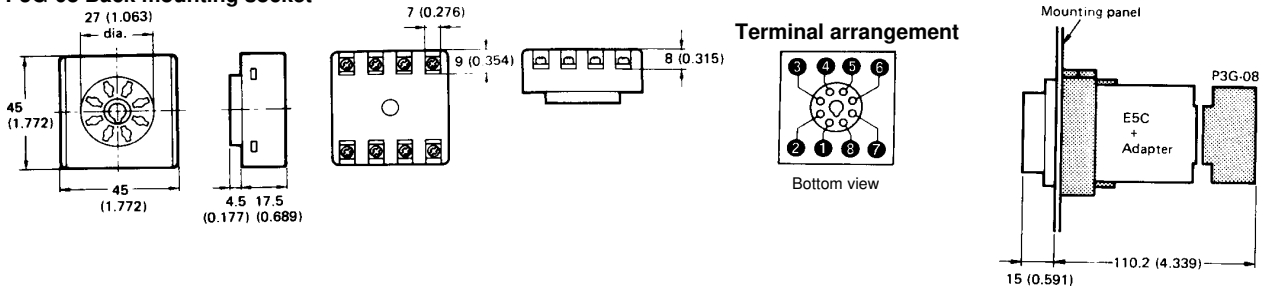

US08 Back-mounting socket

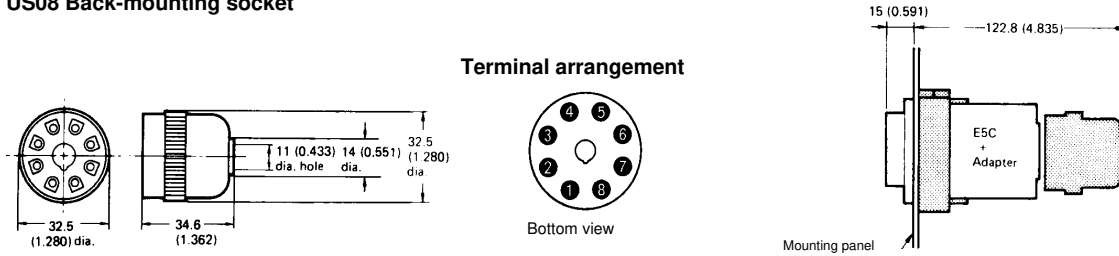

PROTECTIVE COVER

Y92A-48B

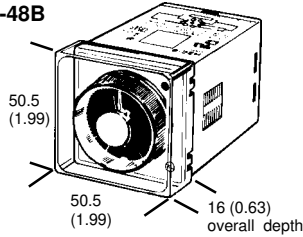

Hard plastic cover Y92A-48B snaps onto the front of the temperature controller to prevent accidental resetting. It also shields the front panel from dirt and water. The cover is intended for use in areas where unusual service conditions do not exist.

MOUNTING TRACK AND ACCESSORIES

PFP-100N/PFP-50N DIN Rail

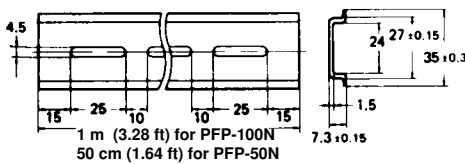

PFP-M End Plate

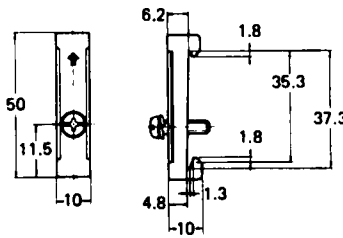

PFP-S Spacer

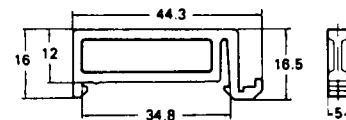

Nomenclature

E5C2

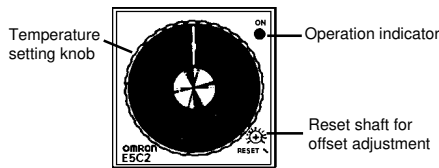

Connections

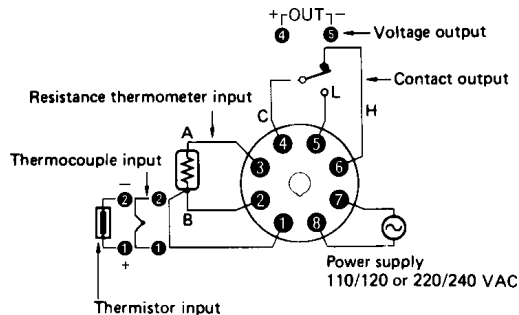

Contact output

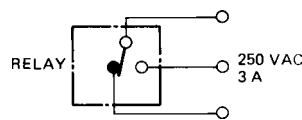

Voltage output

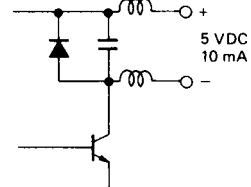



**OMRON ELECTRONICS, INC.**  
One East Commerce Drive  
Schaumburg, IL 60173  
**1-800-55-OMRON**

**OMRON CANADA, INC.**  
885 Milner Avenue  
Scarborough, Ontario M1B 5V8  
**416-286-6465**