



Chipsmall Limited consists of a professional team with an average of over 10 year of expertise in the distribution of electronic components. Based in Hongkong, we have already established firm and mutual-benefit business relationships with customers from,Europe,America and south Asia,supplying obsolete and hard-to-find components to meet their specific needs.

With the principle of “Quality Parts,Customers Priority,Honest Operation,and Considerate Service”,our business mainly focus on the distribution of electronic components. Line cards we deal with include Microchip,ALPS,ROHM,Xilinx,Pulse,ON,Everlight and Freescale. Main products comprise IC,Modules,Potentiometer,IC Socket,Relay,Connector.Our parts cover such applications as commercial,industrial, and automotives areas.

We are looking forward to setting up business relationship with you and hope to provide you with the best service and solution. Let us make a better world for our industry!



Contact us

Tel: +86-755-8981 8866 Fax: +86-755-8427 6832

Email & Skype: info@chipsmall.com Web: www.chipsmall.com

Address: A1208, Overseas Decoration Building, #122 Zhenhua RD., Futian, Shenzhen, China



Temperature Controllers

E5CSZ

Easy Setting Using DIP Switch and Simple Functions in DIN 48 × 48 mm-size Temperature Controllers

- Easy setting using DIP and rotary switches.
- Models with two alarms added to Series, ideal for temperature alarm applications.
- Clearly visible digital display with character height of 13.5 mm.
- Models available with black or white cases.
- RoHS compliant (Scheduled for January 2006).



NEW

Model Number Structure

■ Model Number Legend

Models with Terminal Blocks

E5CSZ-□□□□-□
1 2 3 4 5

1. Output type

- R: Relay
- Q: Voltage for driving SSR

2. Number of alarms

- Blank: No alarm
- 1: 1 alarm

3. Input type

- T: Thermocouple/platinum resistance thermometer (multi-input)

4. Power supply voltage

- Blank: 100 to 240 VAC
- D: 24 VAC/VDC

5. Case color

- Blank: Light gray
- B: Black

Note: A functional explanation is provided here for illustration, but models are not necessarily available for all possible combinations. Refer to *Ordering Information* when ordering.

Example

- Relay control output, one alarm output, multi-input, light gray: E5CSZ-R1T.

Ordering Information

■ List of Models

| Size | Power supply voltage | Number of alarm points | Control output | TC/Pt multi-input Case color: Light gray |
|--|----------------------|------------------------|---------------------------|---|
| 1/16 DIN 48 × 48 × 78 mm (W × H × D) | 100 to 240 VAC | 0 | Relay | E5CSZ-RT |
| | | | Voltage (for driving SSR) | E5CSZ-QT |
| | | 1 | Relay | E5CSZ-R1T |
| | | | Voltage (for driving SSR) | E5CSZ-Q1T |
| | 24 VAC/VDC | 0 | Relay | E5CSZ-RTD |
| | | | Voltage (for driving SSR) | E5CSZ-QTD |
| | | 1 | Relay | E5CSZ-R1TD |
| | | | Voltage (for driving SSR) | E5CSZ-Q1TD |

Note: Modules are available with a black case. Add the suffix “-B” to models with a black case.

■ Accessories (Order Separately)

Protective Cover

| Type | Model |
|-----------------------|----------|
| Hard Protective Cover | Y92A-48B |

Terminal Cover

| Model |
|-----------|
| E53-COV10 |

Specifications

■ Ratings

| | | |
|-------------------------|--|---|
| Supply voltage | 100 to 240 VAC, 50/60 Hz | 24 VAC/VDC, 50/60 Hz |
| Operating voltage range | 85% to 110% of rated supply voltage | |
| Power consumption | 5 VA | 3 VA/2 W |
| Sensor input | Multi-input (thermocouple/platinum resistance thermometer) type: K, J, L, Pt100 | |
| Control output | Relay output | SPST-NO, 250 VAC, 3A (resistive load) |
| | Voltage output (for driving the SSR) | 12 VDC, 21 mA (with short-circuit protection circuit) |
| Control method | ON/OFF or 2-PID (with auto-tuning) | |
| Alarm output | SPST-NO, 250 VAC, 1A (resistive load) | |
| Setting method | Digital setting using front panel keys | |
| Indication method | 3.5 digit, 7-segment digital display (character height: 13.5 mm) and deviation indicators | |
| Other functions | <ul style="list-style-type: none"> • Setting change prohibit (key protection) • Input shift • Temperature unit change (°C/°F) • Direct/reverse operation • Temperature range, Sensor switching (K/J/L, Pt100) • Switching is performed between a thermocouple and platinum resistance thermometer for multi-input models. • Control period switching • 8-mode alarm output • Sensor error detection | |
| Ambient temperature | -10 to 55°C (with no condensation or icing) | |
| Ambient humidity | 25% to 85% | |
| Storage temperature | -25 to 65°C (with no condensation or icing) | |

■ Characteristics

| | |
|--|--|
| Setting accuracy | Thermocouple (See note 1.): (±0.5% of indication value or ±1°C, whichever is greater) ±1 digit max. |
| Indication accuracy (ambient temperature of 23°C) | Platinum resistance thermometer (See note 2.): (±0.5% of indication value or ±1°C, whichever is greater) ±1 digit max. |
| Influence of temperature | Thermocouple inputs: (±1% of PV or ±4°C, whichever is greater) ±1 digit max. |
| Influence of voltage | Platinum resistance thermometer inputs: (±1% of PV or ±2°C, whichever is greater) ±1 digit max. |
| Hysteresis (for ON/OFF control) | 0.1% FS for multi-input (thermocouple/platinum resistance thermometer) models |
| Proportional band (P) | 1 to 999°C (automatic adjustment using auto-tuning/self-tuning) |
| Integral time (I) | 1 to 1,999 s (automatic adjustment using auto-tuning/self-tuning) |
| Derivative time (D) | 1 to 1,999 s (automatic adjustment using auto-tuning/self-tuning) |
| Alarm output range | Absolute-value alarm: Same as the control range Other: 0% to 100% FS Alarm hysteresis: 0.2°C or °F (fixed) |
| Control period | 2/20 s |
| Sampling period | 500 ms |
| Insulation resistance | 20 MΩ min. (at 500 VDC) |
| Dielectric strength | 2,000 VAC, 50/60 Hz for 1 min between current-carrying terminals of different polarity |
| Vibration resistance | Malfunction |
| | Destruction |
| Shock resistance | Malfunction |
| | Destruction |
| Life expectancy | Electrical |
| | |
| Weight | Approx. 120 g (Controller only) |
| Degree of protection | Front panel: Equivalent to IP50; Rear case: IP20; Terminals: IP00 |
| Memory protection | EEPROM (non-volatile memory) (number of writes: 1,000,000) |
| EMC | EMI Radiated: EN 55011 Group 1 Class A EMI Conducted: EN 55011 Group 1 Class A ESD Immunity: EN 61000-4-2: 4 kV contact discharge (level 2) 8 kV air discharge (level 3) Radiated Electromagnetic Field Immunity: EN 61000-4-3: 10 V/m (80-1000 MHz, 1.4-2.0 GHz amplitude modulated) (level 3) 10 V/m (900 MHz pulse modulated) Conducted Disturbance Immunity: EN 61000-4-6: 3 V (0.15 to 80 MHz) (level 2) Noise Immunity (First Transient Burst Noise): EN 61000-4-4 Burst Immunity: 2 kV power-line (level 3), 1 kV I/O signal-line (level 3) Surge Immunity: EN 61000-4-5: Power line: Normal mode 1 kV; Common mode 2 kV Output line (relay output): Normal mode 1 kV; Common mode 2 kV Voltage Dip/Interrupting Immunity: EN 61000-4-11 0.5 cycle, 100% (rated voltage) |
| Approved standards | UL 61010C-1 (listing) CSA C22.2 No.1010-1 |
| Conformed standards | EN 61326, EN 61010-1, IEC 61010-1 VDE 0106 Part 100 (finger protection), when the terminal cover is mounted. |

- Note:** 1. The following exceptions apply to thermocouples.
 • L: ±2°C ±1 digit max.
 2. The following exceptions apply to platinum resistance thermometers.
 Input set values 0, 1, 2, 3 for E5CSZ: 0.5% FS ±1 digit max.
 Input set value 1 for E5CSZ: 0.5% FS ±1 digit max.

■ Electrical Life Expectancy Curve for Relays (Reference Values)

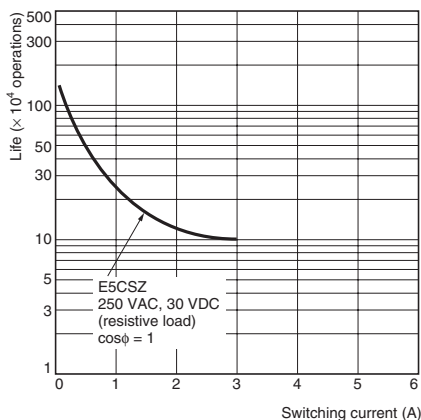

■ Temperature Range

Multi-input (Thermocouple/Platinum Resistance Thermometer) Models

• Using Thermocouple Sensors, Control Mode Switch 5: OFF

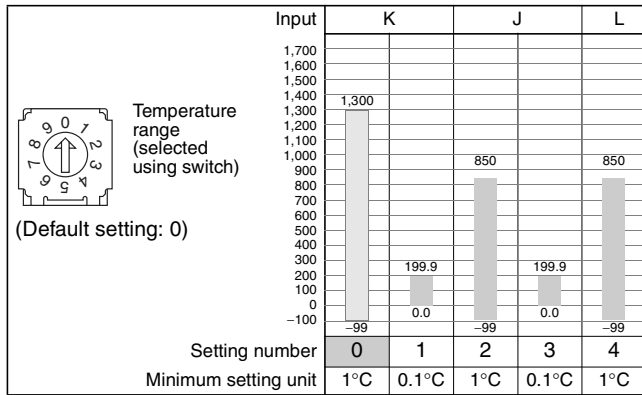

The shaded value indicates the default setting status.
Do not set the temperature range switch to between No. 5 and No. 9.

• Using Platinum Resistance Thermometers, Control Mode Switch 5: ON

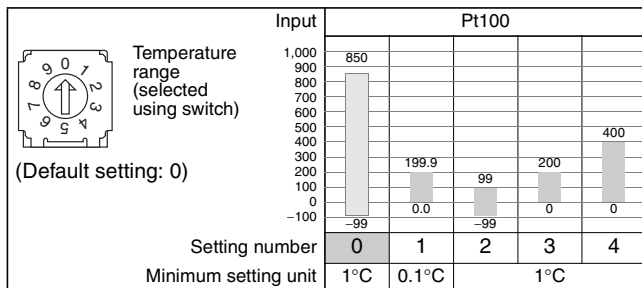

The shaded value indicates the default setting status.
Do not set the temperature range switch to between No. 5 and No. 9.

External Connection Diagram

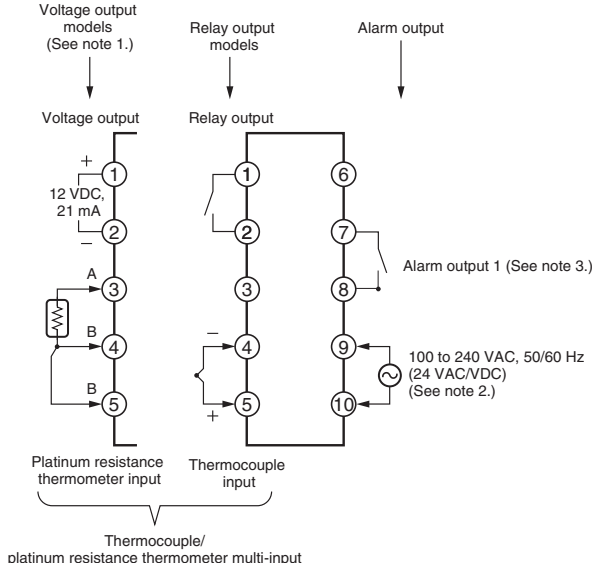

- Note:**
1. The voltage output (12 VDC, 21 mA) is not electrically isolated from the internal circuits. When using a grounding thermocouple, do not connect output terminals 1 or 2 to ground. Otherwise, unwanted current paths will cause measurement errors.
 2. Models with 100 to 240 VAC and 24 VAC/VDC are separate. Models using 24 VDC have no polarity.
 3. The number of alarm outputs (none or 1) depends on the model.

Nomenclature

E5CSZ Models with Terminal Blocks

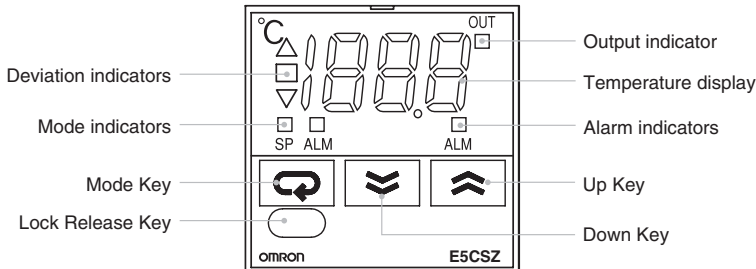

Operation

E5CSZ

Deviation indicators

The \triangle indicator lights when the PV is greater than the SP and the ∇ indicator lights when the PV is less than the SP. The \square indicator (green) lights when the deviation is less than 0.25% FS. These indicators flash during ST (self-tuning)/AT (auto-tuning).

Mode indicators

The SP indicator lights when the setting temperature is being displayed. The ALM indicator lights when the alarm value 1 is being displayed and flashes when the alarm value 2 is being displayed.

Mode Key

When the power is turned ON, normally the display will use the display items in the following order each time the Mode Key is pressed.

```

    graph TD
      PowerON[Power ON] --> PV[PV]
      PV -- "Press the Mode Key" --> SP[SP]
      SP -- "Press the Mode Key" --> Alarm1[Alarm value 1]
      Alarm1 -- "Press the Mode Key" --> InputShift[Input shift value]
      InputShift -.-> Note[This item is not displayed when the Control Mode Switch 4 is OFF.]
      Note -.-> PV
    
```

PV, SP, Alarm Value, Input Shift Display

The display switches each time the Mode Key is pressed.

Output indicator

Lights when the control output is ON.

Alarm indicator

ALM1 (Alarm 1): Lights when the alarm 1 output is ON.

Up Key

Pressing the Up Key increases the SP/alarm value display. Keeping the Up Key pressed continues to increase the display value. When the internal protect switch is ON, press the Up Key while holding down the Lock Release Key.

Down Key

Pressing the Down Key decreases the SP/alarm value display. Keeping the Down Key pressed continues to decrease the display value. When the internal protect switch is ON, press the Down Key while holding down the Lock Release Key.

Lock Release Key

When the protect switch is ON, the set value can be changed by pressing the Up and Down Keys while holding down the Lock Release Key.

Settings before Turning ON the Power

E5CSZ

Remove the E5CSZ from the case to make the settings.

1. Insert the tool into the two tool insertion holes (one on the top and one on the bottom) and release the hooks.

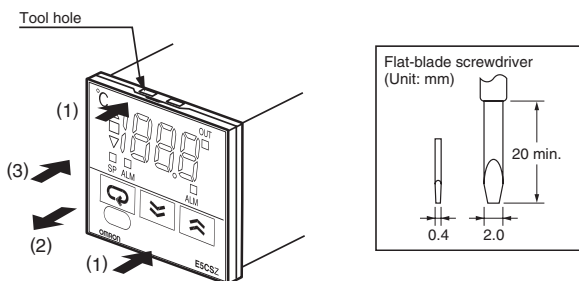

2. Insert the tool in the gap between the front panel and rear case, and pull out the front panel slightly. Grip the front panel and pull out fully. Be sure not to impose excessive force on the panel.

3. When inserting the E5CSZ, check to make sure that the sealing rubber is in place and push the E5CSZ toward the rear case until it snaps into position. While pushing the E5CSZ into place, push down on the hooks on the top and bottom surfaces of the rear case so that the hooks are securely locked in place. Make sure that electronic components do not come into contact with the case.

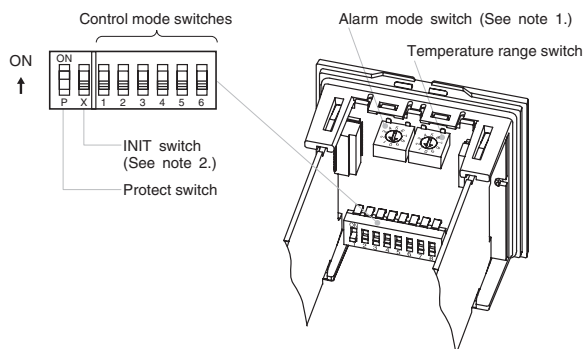

- Note:**
1. The alarm mode switch is not provided on models without an alarm.
 2. The INIT switch is always OFF during normal operation.

1. Sensor Type Specification

Select the number on the temperature range switch to change the temperature range.

Multi-input (Thermocouple/Platinum Resistance Thermometer) Models

• Using Thermocouple Sensors, Control Mode Switch 5: OFF

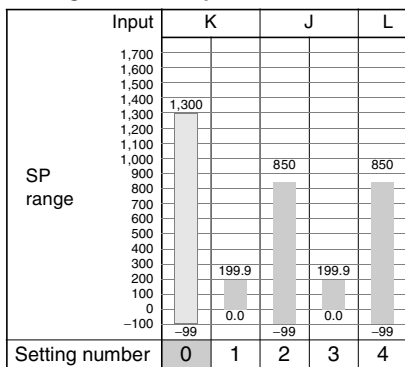

The shaded value indicates the default setting status. Do not set the temperature range switch to between No. 5 and No. 9.

• The control range is -20°C to $+20^{\circ}\text{C}$ of the input temperature range.

- Note:**
- The input indication range is the range that can be displayed for the control range (-99 to 1999). If the input is within the control range but exceeds the display range (-99 to 1999), values below -99 will be displayed as "ccc" and values above $1,999$ will be displayed as "kkk."
 - If unit is changed to 1 degree when the SP and alarm value for the temperature range are displayed in 0.1-units from 0.0 to 199.9 or 0.0 to 99.9, the values will be multiplied by 10 (e.g., 0.5 becomes 5). If the unit is changed in the reverse direction, the values will be divided by 10. After changing the range, set the SP and alarm value again.

• Using Platinum Resistance Thermometers, Control Mode Switch 5: ON

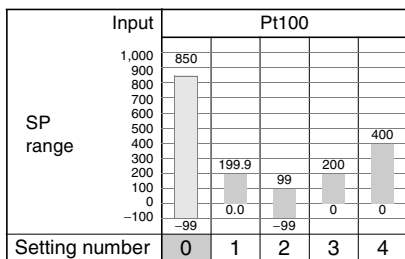

The shaded value indicates the default setting status. Do not set the temperature range switch to between No. 5 and No. 9.

• The control range is -20°C to $+20^{\circ}\text{C}$ of the input temperature range.

- Note:**
- The input indication range is the range that can be displayed for the control range (-99 to 1999). If the input is within the control range but exceeds the display range (-99 to 1999), values below -99 will be displayed as "ccc" and values above $1,999$ will be displayed as "kkk."
 - If unit is changed to 1 degree when the SP and alarm value for the temperature range are displayed in 0.1-units from 0.0 to 199.9 or 0.0 to 99.9, the values will be multiplied by 10 (e.g., 0.5 becomes 5). If the unit is changed in the reverse direction, the values will be divided by 10. After changing the range, set the SP and alarm value again.

Mode Key Display Order

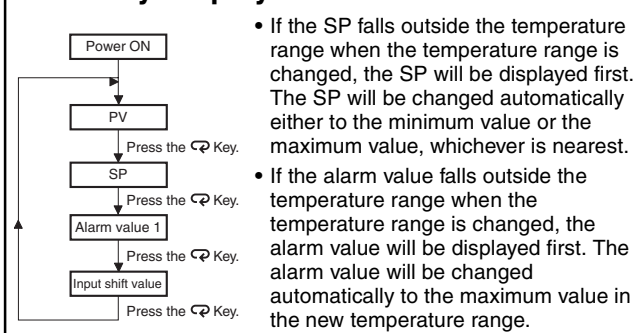

- If the SP falls outside the temperature range when the temperature range is changed, the SP will be displayed first. The SP will be changed automatically either to the minimum value or the maximum value, whichever is nearest.
- If the alarm value falls outside the temperature range when the temperature range is changed, the alarm value will be displayed first. The alarm value will be changed automatically to the maximum value in the new temperature range.

2. Operation Settings



Use the control mode switches () to change the control mode. (All switches are OFF for the default settings.)



| Function selection | | 1 | 2 | 3 | 4 | 5 | 6 |
|------------------------------|--|---------------------------------------|-----|-----|-----|-----|-----|
| ON/OFF PID | PID control | ON | | | | | |
| | ON/OFF control | OFF | | | | | |
| Control period | 2 s | | ON | | | | |
| | 20 s | | OFF | | | | |
| Direct/reverse operation | Direct operation (cooling) | | | ON | | | |
| | Reverse operation (heating) | | | OFF | | | |
| Input shift display | Enabled | | | | ON | | |
| | Disabled | | | | OFF | | |
| Temperature Sensor selection | Multi-input (thermocouple/platinum resistance thermometer) | Platinum resistance thermometer input | | | | ON | |
| | | Thermocouple input | | | | OFF | |
| Temperature unit | °F | | | | | | ON |
| | °C | | | | | | OFF |

3. Alarm Modes

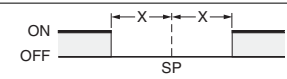
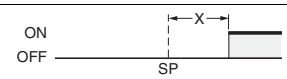
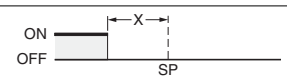
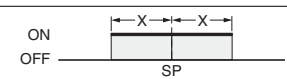
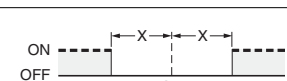
Select the number of the alarm mode switch  when changing the alarm mode. (The default is 2).

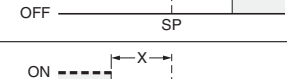
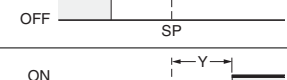
| Set value | Alarm type | Alarm output operation |
|-----------|--|--|
| 0, 9 | Alarm function OFF | OFF |
| 1 | Upper- and lower-limit |  |
| 2 | Upper-limit |  |
| 3 | Lower-limit |  |
| 4 | Upper- and lower-limit range |  |
| 5 | Upper- and lower-limit with standby sequence (See note 2.) |  |
| 6 | Upper-limit with standby sequence (See note 2.) |  |
| 7 | Lower-limit with standby sequence (See note 2.) |  |
| 8 | Absolute-value upper-limit |  |

Note: 1. No alarm. The alarm value (alarm operation display) will not be displayed when the setting is 0 or 9 even if the selection key is pressed.

Alarm Setting Range

X: 0 to FS (full scale); Y: Within temperature range

The value of X is the deviation setting for the SP (set point).

2. Standby Sequence Function (The standby sequence operates when the power is turned ON.)

Rising Temperature

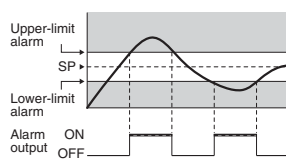

Dropping Temperature

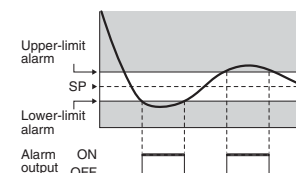

Note: Turn OFF the power before changing the DIP switch settings on the E5CSZ. Each of the switch settings will be enabled after the power is turned ON.

For details on the position of the temperature range switch, control mode switches, and alarm mode switch, refer to page 6.

4. Using the Control Mode Switches

(1) Using ON/OFF Control and PID Control

ON/OFF Control

The control mode is set to ON/OFF control as the default setting.

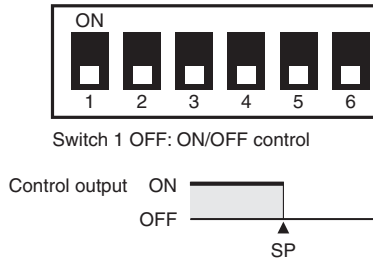

To perform cooling control of freezers, etc., turn ON switch 3.

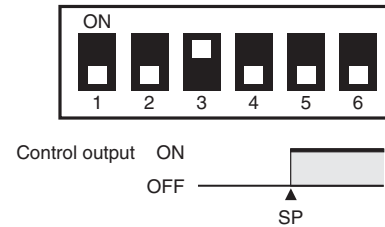

PID Control

Turn ON switch 1 to use PID control.

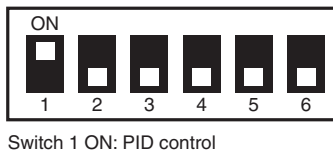

1. Set the control period.

Performing Control via Relay Output, External Relay, or Conductor

Switch 2: OFF (control period: 20 s)

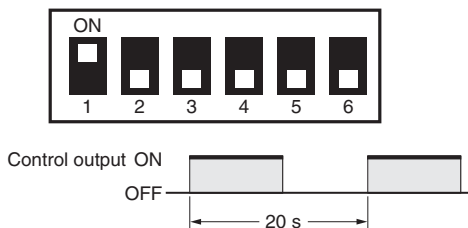

Quick Control Response Using an SSR

Switch 2: ON (control period: 2 s)

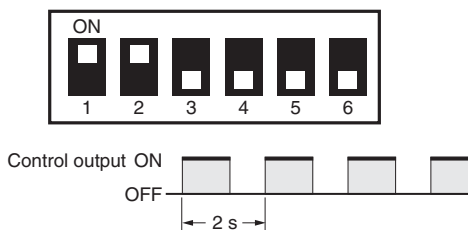

2. Set direct/reverse operation for the output.

Performing Heating Control for Heaters

Switch 3: OFF

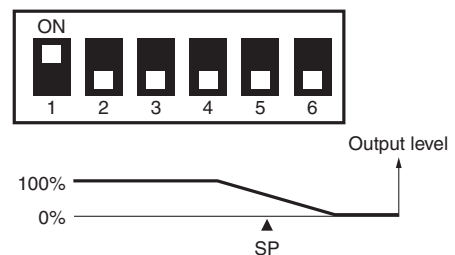

Performing Cooling Control for Freezers

Switch 3: ON

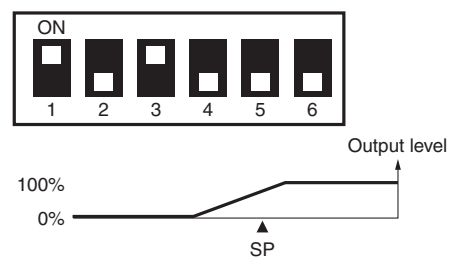

ST (Self-tuning) Features

ST (self-tuning) is a function that finds PID constants by using step response tuning (SRT) when Controller operation begins or when the set point is changed. Once the PID constants have been calculated, ST is not executed when the next control operation is started as long as the set point remains unchanged. When the ST function is in operation, be sure to turn ON the power supply of the load connected to the control output simultaneously with or before starting Controller operation.

Executing AT (Auto-tuning)

AT (auto-tuning) is executed by pressing the Up and Down Keys for at least 2 s while the PV is displayed. The deviation indicators flash during auto-tuning (AT) execution. AT will be cancelled by performing the same operation that AT is executing during AT operation. Flashing stops when AT is completed.

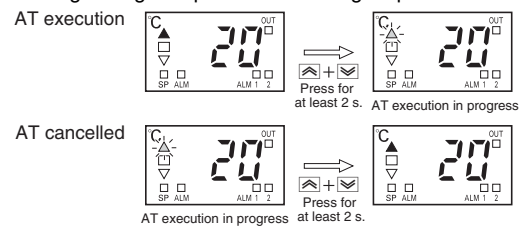

Note: One of the deviation indicators () will flash.

(2) Using the E5CSZ in Devices for Fahrenheit-scale Users

(Displaying in °F)

Turn ON switch 6 to display temperatures in °F.



Temperature Range for °F

The temperature is set to °F using the same temperature range switch as °C.

**Multi-input (Thermocouple/
Platinum Resistance
Thermometer)**

Control mode switch 5: OFF

| Set-ting | | °F |
|----------|---|--------------|
| 0 | K | -99 to 1999 |
| 1 | | 0.0 to 199.9 |
| 2 | J | -99 to 1500 |
| 3 | | 0.0 to 199.9 |
| 4 | L | -99 to 1500 |

**Multi-input (Thermocouple/
Platinum Resistance
Thermometer)**

Control mode switch 5: ON

| Set-ting | | °F |
|----------|-------|--------------|
| 0 | Pt100 | -99 to 1500 |
| 1 | | 0.0 to 199.9 |
| 2 | | -99 to 99 |
| 3 | | 0 to 200 |
| 4 | | 0 to 400 |

Note: The control range for multi-input (thermocouple/platinum resistance thermometer) models is -40 to +40°F of each temperature range.

(3) Setting Input Shift

Turn ON switch 4, and after turning ON the power, press the Mode Key until **H0** (indicates input shift of 0) is displayed. Press the Up and Down Keys to set the shift value.



Shift Example

| Input shift display | Measured temperature | Temperature display |
|------------------------|----------------------|---------------------|
| H0 (no shift) | 100°C | 100°C |
| H9 (+9°C shift) | 100°C | 109°C |
| L9 (-9°C shift) | 100°C | 91°C |

Note: When control mode switch 4 is turned OFF (no input shift display), the input shift is not displayed but the shift value is enabled. To disable input shift, set the input shift value to **H0**. The shift range depends on the setting unit.

| | | |
|----------------------------|--------------|----------------|
| Setting unit | 1°C | 0.1°C |
| Compensation range | -99 to +99°C | -9.9 to +9.9°C |
| Input shift display | L99 to H99 | L9.9 to H9.9 |

5. Protect Switch

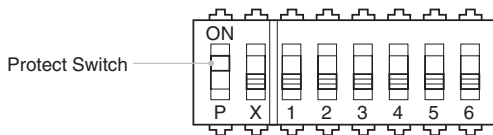

When the protect switch is ON, Up Key and Down Key operations are prohibited to prevent setting mistakes.

Installation

- All models in the E5CSZ Series conform to DIN 43700 standards.
- The recommended panel thickness is 1 to 4 mm.
- Be sure to mount the E5CSZ horizontally.

Mounting the E5CSZ

1. Insert the E5CSZ into the mounting hole in the panel.
2. Push the adapter from the terminals up to the panel, and temporarily fasten the E5CSZ.
3. Tighten the two fastening screws on the adapter. Alternately tighten the two screws little by little to maintain a balance. Tighten the screws to a torque of 0.29 to 0.39 N·m.

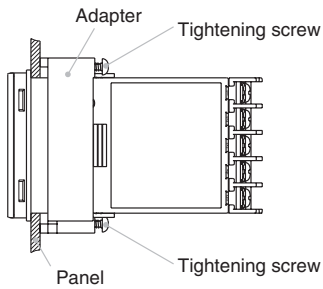

Error Displays and Causes

In addition to the alarm indicator, errors notification is provided on the display. Be sure to remove the cause of the error promptly.

| Display status | Cause | Control output |
|----------------------------|--|--|
| PV displayed as <i>FFF</i> | The process value is higher than the control temperature range (overflow). | Heating control (reverse operation): OFF Cooling control (direct operation): ON |
| PV displayed as --- | The process value is lower than the control temperature range (underflow). | Heating control (reverse operation): ON Cooling control (direct operation): OFF |
| <i>FFF</i> flashing | Multi-input (Thermocouple/platinum resistance thermometer) models: The process value is higher than the control temperature range or a Sensor error has occurred. | OFF |
| --- flashing | Multi-input (Thermocouple/platinum resistance thermometer) models: The process value is lower than the control temperature range or a Sensor error has occurred. | OFF |
| <i>E 11</i> is displayed | A memory error (E11) has occurred. Turn the power ON again. If the display remains the same, the Controller must be repaired. | The control outputs and alarm outputs turn OFF. |

Note: In models with an alarm, *FFF* appears or flashes on the display to indicate that the temperature has exceeded the maximum display temperature and the output is set according to the alarm mode. In the same way, --- appears or flashes on the display to indicate that the temperature has exceeded the minimum display temperature and the output is set according to the alarm mode.

Sensor Error Displays and Causes

■ Thermocouple

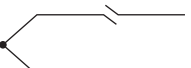
| Status | Display | Control output |
|---|---------------------|----------------|
| Burnout  | <i>FFF</i> flashing | OFF |

Note: The room temperature is displayed if an input short-circuit occurs.

■ Platinum Resistance Thermometer

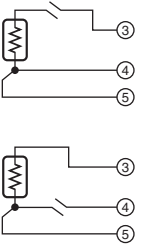
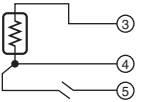
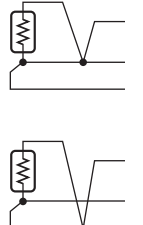
| Status | Display | Control output |
|--|---------------------|----------------|
| Burnout  | <i>FFF</i> flashing | OFF |
|  | --- flashing | OFF |
| 2 or 3 wires disconnected | <i>FFF</i> flashing | OFF |
| Short-circuit  | --- flashing | OFF |

Note: The resistance value for platinum resistance thermometers is 100 Ω at 0°C and 140 Ω at 100°C.

Comparison with E5CST

■ Model Number Legend

| Previous model | | | | E5CSZ | | | |
|--|----------------|---------|---|----------------------------------|------------------------|---------|--|
| E5CST-□□□ 1 2 3 | | | | E5CSZ-□□□□-□ 1 2 3 4 5 | | | |
| Classification | Symbol | Meaning | | Classification | Symbol | Meaning | |
| 1 | Control output | R | Relay: SPDT (single-pole, double-throw) | 1 | Control output | R | Relay: SPST-NO (single-pole, single-throw, normally open) |
| | | Q | Voltage | | | Q | Voltage |
| 2 | Alarm output | 1 | One alarm | 2 | Alarm output | Blank | No alarms |
| | | | | | | 1 | One alarm |
| 3 | Input type | KJ | Thermocouple (K, J) | 3 | Input type | T | Multi-input (thermocouple/ platinum resistance thermometer) models |
| | | P | Platinum resistance thermometer (Pt100, JPt100) | | | | |
| Main Differences Terminal block models use the model number E5CSZ. The suffix "D" is added to models with a supply voltage of 24 VAC/VDC. The suffix "B" is added to models with a black case. | | | | 4 | Voltage specifications | Blank | 100 to 240 VAC |
| | | | | | | D | 24 VAC/VDC |
| | | | | 5 | Case color | Blank | Light gray |
| | | | | | | B | Black |

■ Display

| Previous model | E5CSZ |
|----------------|-------|
| | |

The display digits can be increased up to 1,999.
 The display "ON" has changed to "OUT" and "AL" has changed to "ALM."

■ Functions

The control outputs for relay outputs have been changed from SPDT (single-pole, double-throw) to SPST-NO (single-pole, single-throw, normally open) contacts.
 The control method has been changed to 2-PID control.
 An auto-tuning (AT) function has been added.
 The deviation display flashes during self-tuning (ST) and auto-tuning (AT).
 The control calculation period has been improved from 2 s to 0.5 s.

■ External Dimensions

The depth has been shortened from 100 mm to 76 mm.

■ Terminal Arrangement

- The terminal arrangement has changed from a horizontal to vertical configuration.

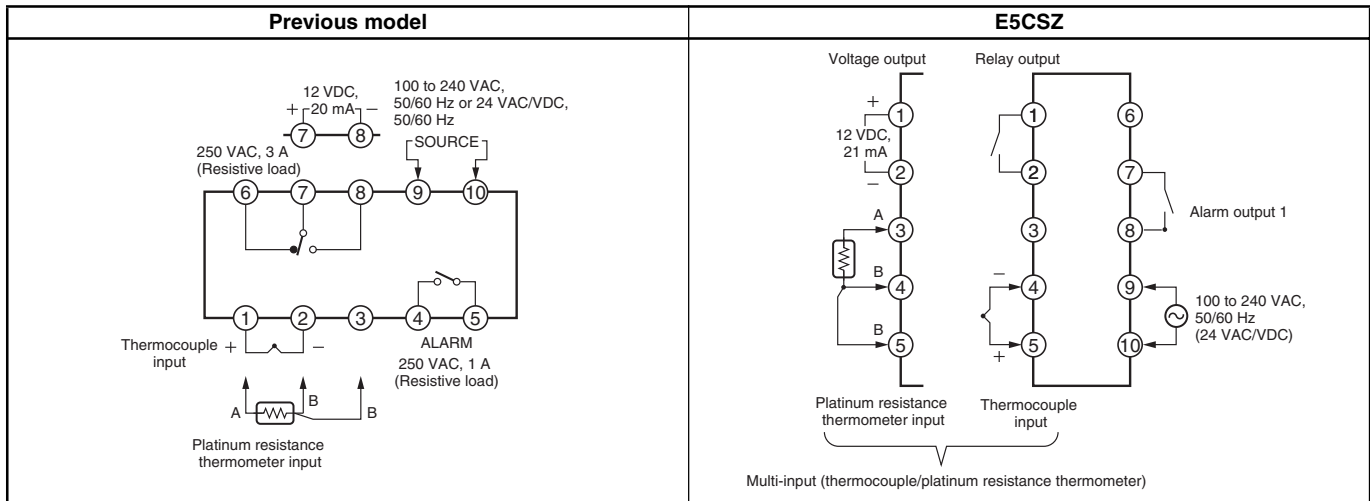

■ DIP Switch and Rotary Switch Setting Methods

| Previous model | | E5CSZ | | | | | | | |
|-------------------------------------|--|-----------------------------|-------------|-----|-----|--|--|-----|-----|
| | | | | | | | | | |
| Control Model Switch | | Control Model Switch | | | | | | | |
| Function selection | 1 2 3 4 5 6 | Function selection | 1 2 3 4 5 6 | | | | | | |
| ON/OFF PID | PID control | ON | | | | | | | |
| | ON/OFF control | OFF | | | | | | | |
| Control period | 2 s | | ON | | | | | | |
| | 20 s | | OFF | | | | | | |
| Direct/reverse operation | Direct operation (cooling) | | | ON | | | | | |
| | Reverse operation (heating) | | | OFF | | | | | |
| Input shift display | Enabled | | | | ON | | | | |
| | Disabled | | | | OFF | | | | |
| Temperature Sensor selection | Multi-input (thermocouple/platinum resistance thermometer) | | | | | | | ON | |
| | Thermocouple input | | | | | | | OFF | |
| Temperature unit | °F | | | | | | | | ON |
| | °C | | | | | | | | OFF |

| Previous model | | | | E5CSZ | | | |
|---|--|----------------------|--------------------------------------|----------|----------|--|--|
| Function Selection | | | | 4 | | | |
| Alarm Modes | Lower-limit | | | ON | | | |
| | Upper-limit | | | OFF | | | |
| Function selection | | | | 5 | 6 | | |
| Temperature Range | KJ | J: 0 to 300°C | ON | ON | | | |
| | | K: 0 to 999°C | OFF | ON | | | |
| | | K: 0 to 500°C | ON | OFF | | | |
| | | K: 0 to 300°C | OFF | OFF | | | |
| | P | --- | ON | ON | | | |
| | | Pt100: 0 to 300°C | OFF | ON | | | |
| Pt100: 0.0 to 99.0°C | | ON | OFF | | | | |
| | | Pt100: 0.0 to 50.0°C | OFF | OFF | | | |
| Alarm Mode Switch (Alarm Model Only) | | | | | | | |
| Set value | Alarm type | | Alarm output operation | | | | |
| 0, 9 | Alarm function OFF | | OFF | | | | |
| 1 | Upper- and lower-limit | | | | | | |
| 2 | Upper-limit | | | | | | |
| 3 | Lower-limit | | | | | | |
| 4 | Upper- and lower-limit range | | | | | | |
| 5 | Upper- and lower-limit with standby sequence (See note 2.) | | | | | | |
| 6 | Upper-limit with standby sequence (See note 2.) | | | | | | |
| 7 | Lower-limit with standby sequence (See note 2.) | | | | | | |
| 8 | Absolute-value upper-limit | | | | | | |
| Temperature Range Switch | | | | | | | |
| Set value | Control Mode Switch 5: | | Temperature Range | | | | |
| 0 | OFF | | K: 0 to 1,300°C/-99 to 1,999°F | | | | |
| 1 | OFF | | K: 0.0 to 199.9°C/0.0 to 199.9°F | | | | |
| 2 | OFF | | J: -99 to 850°C/-99 to 1,500°F | | | | |
| 3 | OFF | | J: 0.0 to 199.9°C/0.0 to 199.9°F | | | | |
| 4 | OFF | | L: -99 to 850°C/-99 to 1,500°F | | | | |
| 0 | ON | | Pt100: -99 to 850°C/-99 to 1,500°F | | | | |
| 1 | ON | | Pt100: 0.0 to 199.9°C/0.0 to 199.9°F | | | | |
| 2 | ON | | Pt100: -99 to 99°C/-99 to 99°F | | | | |
| 3 | ON | | Pt100: 0 to 200°C/0 to 200°F | | | | |
| 4 | ON | | Pt100: 0 to 400°C/0 to 400°F | | | | |

Dimensions

Note: All units are in millimeters unless otherwise indicated.

Controller

E5CSZ

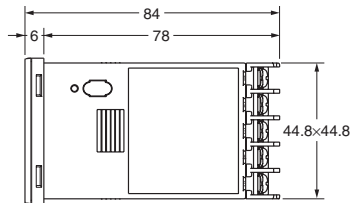
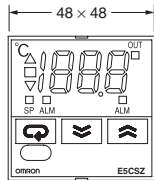
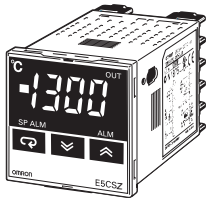

Panel Cutout Dimensions

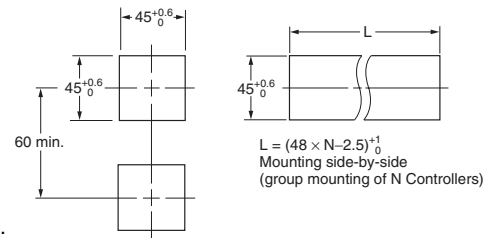

Note: Terminals cannot be removed.

E5CSZ + Adapter for Flush Mounting (Provided)

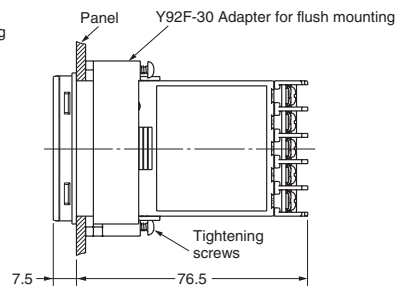
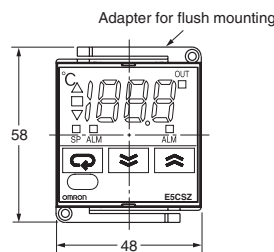
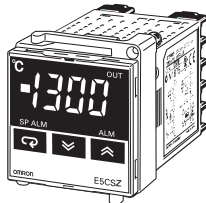
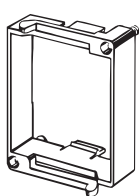

- Note: 1. The recommended panel thickness is 1 to 4 mm.
2. Group mounting is possible in one direction only.

Hard Protective Cover

The Y92A-48B Protective Cover (hard type) is available for the following applications.

- To protect the set from dust and dirt.
- To prevent the panel from being accidentally touched causing displacement of set values.
- To provide effective protection against water droplets.

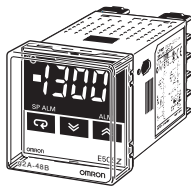

Terminal Cover

E53-COV10

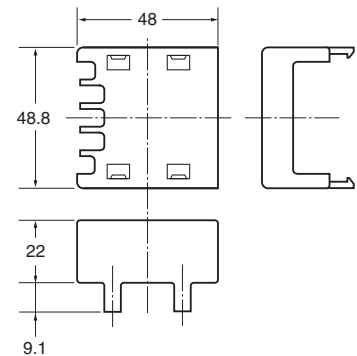
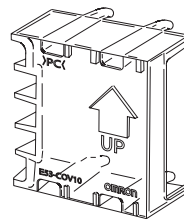

Precautions

CAUTION

Do not touch the terminals while power is being supplied. Doing so may occasionally result in minor injury due to electric shock.



Do not allow pieces of metal, wire clippings, or fine metallic shavings or filings from installation to enter the product. Doing so may occasionally result in electric shock, fire, or malfunction.



Do not use the product where subject to flammable or explosive gas. Otherwise, minor injury from explosion may occasionally occur.



Never disassemble, modify, or repair the product or touch any of the internal parts. Minor electric shock, fire, or malfunction may occasionally occur.



CAUTION - Risk of Fire and Electric Shock

- a) This product is UL listed as Open Type Process Control Equipment. It must be mounted in an enclosure that does not allow fire to escape externally.
- b) More than one disconnect switch may be required to de-energize the equipment before servicing the product.
- c) Signal inputs are SELV, limited energy. (See note 1.)
- d) Caution: To reduce the risk of fire or electric shock, do not interconnect the outputs of different Class 2 circuits. (See note 2.)



If the output relays are used past their life expectancy, contact fusing or burning may occasionally occur. Always consider the application conditions and use the output relays within their rated load and electrical life expectancy. The life expectancy of output relays varies considerably with the output load and switching conditions.



Loose screws may occasionally result in fire. Tighten terminal screws to the specified torque of 0.74 to 0.90 N·m.



Unexpected operation may result in equipment damage or accidents if the settings are not appropriate for the controlled system. Set the Temperature Controller as follows:

- Set the parameters of the Temperature Controller so that they are appropriate for the controlled system.
- Turn the power supply to the Temperature Controller OFF before changing any switch setting. Switch settings are read only when the power supply is turned ON.
- Make sure that the INIT switch in the control mode switches is turned OFF before operating the Temperature Controller.



A malfunction in the Temperature Controller may occasionally make control operations impossible or prevent alarm outputs, resulting in property damage. To maintain safety in the event of malfunction of the Temperature Controller, take appropriate safety measures, such as installing a monitoring device on a separate line.



Faulty terminal contact or decreased waterproofing capability may result in a fire or equipment malfunction. When inserting the Temperature Controller into the rear case after setting the switches, check the watertight packing and make sure that the top and bottom hooks are locked securely in place.



- Note:**
1. A SELV circuit is one separated from the power supply with double insulation or reinforced insulation, that does not exceed 30 V r.m.s. and 42.4 V peak or 60 VDC.
 2. A class 2 power supply is one tested and certified by UL as having the current and voltage of the secondary output restricted to specific levels.

■ Precautions for Safe Use

Be sure to observe the following precautions to prevent operation failure, malfunction, or adverse effects on the performance and functions of the product. Not doing so may occasionally result in unexpected events.

1. The product is designed for indoor use only. Do not use the product outdoors or in any of the following locations.
 - Places directly subject to heat radiated from heating equipment.
 - Places subject to splashing liquid or oil atmosphere.
 - Places subject to direct sunlight.
 - Places subject to dust or corrosive gas (in particular, sulfide gas and ammonia gas).
 - Places subject to intense temperature change.
 - Places subject to icing and condensation.
 - Places subject to vibration and large shocks.
2. Use and store the product within the rated temperature and humidity ranges.

Group-mounting two or more Temperature Controllers, or mounting Temperature Controllers above each other may cause heat to build up inside the Temperature Controllers, which will shorten their service life. In such a case, use forced cooling by fans or other means of air ventilation to cool down the Temperature Controllers.
3. To allow heat to escape, do not block the area around the product. Do not block the ventilation holes on the product.
4. Use the specified size (M3.5, width of 7.2 mm or less) crimped terminals for wiring. To connect bare wires to the terminal block, use copper braided or solid wires with a gage of AWG24 to AWG18 (equal to a cross-sectional area of 0.205 to 0.832 mm²). (The stripping length is 5 to 6 mm.) Up to two wires of the same size and type, or two crimp terminals can be inserted into a single terminal.
5. Be sure to wire properly with correct polarity of terminals. Do not wire any of the I/O terminals incorrectly.
6. Do not wire the terminals that are not used.
7. The voltage output (control output) is not electrically isolated from the internal circuits. When using a grounded temperature sensor, do not connect any of the control output terminals to ground. Otherwise unwanted current paths will cause measurement errors.
8. To avoid inductive noise, keep the wiring for the Temperature Controller's terminal block away from power cables carrying high voltages or large currents. Also, do not wire power lines together with or parallel to Temperature Controller wiring. Using shielded cables and using separate conduits or ducts is recommended. Attach a surge suppressor or noise filter to peripheral devices that generate noise (in particular, motors, transformers, solenoids, magnetic coils or other equipment that have an inductance component).

When a noise filter is used at the power supply, first check the voltage or current, and attach the noise filter as close as possible to the temperature controller.

Allow as much space as possible between the Temperature Controller and devices that generate powerful high frequencies (high-frequency welders, high-frequency sewing machines, etc.) or surge.

9. Use the product within the rated load and power supply.
10. Use a switch, relay, or other contact so that the power supply voltage reaches the rated voltage within 2 seconds. If the applied voltage is increased gradually, the power supply may not be reset or malfunctions may occur.
11. When using PID operation (self-tuning), turn ON the power supply to the load (e.g., heater) at the same time or before turning the power supply to the Temperature Controller ON. If power is turned ON for the Temperature Controller before turning ON power supply to the load, self-tuning will not be performed properly and optimum control will not be achieved.
12. Design the system (e.g., control panel) to allow for the 2 seconds of delay required for the Temperature Controller's output to stabilize after the power is turned ON.
13. A switch or circuit breaker should be provided close to this unit. The switch or circuit breaker should be within easy reach of the operator, and must be marked as a disconnecting means for this unit.
14. Approximately 30 minutes is required for the correct temperature to be displayed after turning the power supply to the Temperature Controller ON. Turn the power supply ON at least 30 minutes prior to starting control operations.
15. Be sure that the platinum resistance thermometer type and the input type set on the Temperature Controller are the same.
16. When extending the thermocouple lead wires, always use compensating conductors suitable for the type of thermocouple. Do not extend the lead wires on a platinum resistance thermometer. Use only low-resistance wire (5 Ω max. per line) for lead wires and make sure that the resistance is the same for all three wires.
17. When drawing out the Temperature Controller from the case, do not apply force that would deform or alter the Temperature Controller.
18. When drawing out the Temperature Controller from the case to replace the Temperature Controller, check the status of the terminals. If corroded terminals are used, contact faults with the terminals may cause the temperature inside the Temperature Controller to increase, possibly resulting in fire. If the terminals are corroded, replace the rear case as well.
19. When drawing out the Temperature Controller from the case, turn the power supply OFF first, and absolutely do not touch the terminals or electronic components or apply shock to them. When inserting the Temperature Controller, do not allow the electronic components to come into contact with the case.
20. Static electricity may damage internal components. Always touch grounded metal to discharge any static electricity before handling the Temperature Controller. When drawing out the Temperature Controller from the case, do not touch the electronic components or patterns on the board with your hand. Hold the Temperature Controller by the edge of the front panel when handling it.
21. Do not use paint thinner or similar chemical to clean with. Use standard grade alcohol.
22. Use tools when separating parts for disposal. Contact with the sharp internal parts may cause injury.

■ Precautions for Correct Use

Service Life

Use the Temperature Controller within the following temperature and humidity ranges:

Temperature: -10 to 55°C (with no icing or condensation)

Humidity: 25% to 85%

If the Controller is installed inside a control board, the ambient temperature must be kept to under 55°C , including the temperature around the Controller.

The service life of electronic devices like Temperature Controllers is determined not only by the number of times the relay is switched but also by the service life of internal electronic components. Component service life is affected by the ambient temperature: the higher the temperature, the shorter the service life and, the lower the temperature, the longer the service life. Therefore, the service life can be extended by lowering the temperature of the Temperature Controller.

When two or more Temperature Controllers are mounted horizontally close to each other or vertically next to one another, the internal temperature will increase due to heat radiated by the Temperature Controllers and the service life will decrease. In such a case, use forced cooling by fans or other means of air ventilation to cool down the Temperature Controllers. When providing forced cooling, however, be careful not to cool down the terminals sections alone to avoid measurement errors.

Measurement Accuracy

When extending or connecting the thermocouple lead wire, be sure to use compensating wires that match the thermocouple type. Do not extend the lead wire of the platinum resistance thermometer. If the lead wire of the platinum resistance thermometer must be extended, be sure to use wires that have low resistance and keep the resistance of the three lead wires the same.

Mount the Temperature Controller so that it is horizontally level.

If the measurement accuracy is low, check whether the input shift has been set correctly.

Warranty and Application Considerations

Read and Understand this Catalog

Please read and understand this catalog before purchasing the products. Please consult your OMRON representative if you have any questions or comments.

Warranty and Limitations of Liability

WARRANTY

OMRON's exclusive warranty is that the products are free from defects in materials and workmanship for a period of one year (or other period if specified) from date of sale by OMRON.

OMRON MAKES NO WARRANTY OR REPRESENTATION, EXPRESS OR IMPLIED, REGARDING NON-INFRINGEMENT, MERCHANTABILITY, OR FITNESS FOR PARTICULAR PURPOSE OF THE PRODUCTS. ANY BUYER OR USER ACKNOWLEDGES THAT THE BUYER OR USER ALONE HAS DETERMINED THAT THE PRODUCTS WILL SUITABLY MEET THE REQUIREMENTS OF THEIR INTENDED USE. OMRON DISCLAIMS ALL OTHER WARRANTIES, EXPRESS OR IMPLIED.

LIMITATIONS OF LIABILITY

OMRON SHALL NOT BE RESPONSIBLE FOR SPECIAL, INDIRECT, OR CONSEQUENTIAL DAMAGES, LOSS OF PROFITS, OR COMMERCIAL LOSS IN ANY WAY CONNECTED WITH THE PRODUCTS, WHETHER SUCH CLAIM IS BASED ON CONTRACT, WARRANTY, NEGLIGENCE, OR STRICT LIABILITY.

In no event shall the responsibility of OMRON for any act exceed the individual price of the product on which liability is asserted.

IN NO EVENT SHALL OMRON BE RESPONSIBLE FOR WARRANTY, REPAIR, OR OTHER CLAIMS REGARDING THE PRODUCTS UNLESS OMRON'S ANALYSIS CONFIRMS THAT THE PRODUCTS WERE PROPERLY HANDLED, STORED, INSTALLED, AND MAINTAINED AND NOT SUBJECT TO CONTAMINATION, ABUSE, MISUSE, OR INAPPROPRIATE MODIFICATION OR REPAIR.

Application Considerations

SUITABILITY FOR USE

OMRON shall not be responsible for conformity with any standards, codes, or regulations that apply to the combination of products in the customer's application or use of the products.

Take all necessary steps to determine the suitability of the product for the systems, machines, and equipment with which it will be used.

Know and observe all prohibitions of use applicable to this product.

NEVER USE THE PRODUCTS FOR AN APPLICATION INVOLVING SERIOUS RISK TO LIFE OR PROPERTY WITHOUT ENSURING THAT THE SYSTEM AS A WHOLE HAS BEEN DESIGNED TO ADDRESS THE RISKS, AND THAT THE OMRON PRODUCTS ARE PROPERLY RATED AND INSTALLED FOR THE INTENDED USE WITHIN THE OVERALL EQUIPMENT OR SYSTEM.

Disclaimers

PERFORMANCE DATA

Performance data given in this catalog is provided as a guide for the user in determining suitability and does not constitute a warranty. It may represent the result of OMRON's test conditions, and the users must correlate it to actual application requirements. Actual performance is subject to the OMRON *Warranty and Limitations of Liability*.

CHANGE IN SPECIFICATIONS

Product specifications and accessories may be changed at any time based on improvements and other reasons. Consult with your OMRON representative at any time to confirm actual specifications of purchased product.

DIMENSIONS AND WEIGHTS

Dimensions and weights are nominal and are not to be used for manufacturing purposes, even when tolerances are shown.

ALL DIMENSIONS SHOWN ARE IN MILLIMETERS.

To convert millimeters into inches, multiply by 0.03937. To convert grams into ounces, multiply by 0.03527.

Cat. No. H141-E1-01 **In the interest of product improvement, specifications are subject to change without notice.**

OMRON Corporation

Industrial Automation Company

Control Devices Division H.Q.

Analog Controller Division

Shiokoji Horikawa, Shimogyo-ku,

Kyoto, 600-8530 Japan

Tel: (81)75-344-7080/Fax: (81)75-344-7189