



Chipsmall Limited consists of a professional team with an average of over 10 year of expertise in the distribution of electronic components. Based in Hongkong, we have already established firm and mutual-benefit business relationships with customers from,Europe,America and south Asia,supplying obsolete and hard-to-find components to meet their specific needs.

With the principle of “Quality Parts,Customers Priority,Honest Operation,and Considerate Service”,our business mainly focus on the distribution of electronic components. Line cards we deal with include Microchip,ALPS,ROHM,Xilinx,Pulse,ON,Everlight and Freescale. Main products comprise IC,Modules,Potentiometer,IC Socket,Relay,Connector.Our parts cover such applications as commercial,industrial, and automotives areas.

We are looking forward to setting up business relationship with you and hope to provide you with the best service and solution. Let us make a better world for our industry!



Contact us

Tel: +86-755-8981 8866 Fax: +86-755-8427 6832

Email & Skype: info@chipsmall.com Web: www.chipsmall.com

Address: A1208, Overseas Decoration Building, #122 Zhenhua RD., Futian, Shenzhen, China



E6F-C

Rugged Rotary Encoder

- Incremental model
- External diameter of 60 mm.
- Resolution of up to 1000 ppr.
- IP65 oil-resistance with strong shaft.
Radial: 120 N, Thrust: 50 N



For the most recent information on models that have been certified for safety standards, refer to your OMRON website.

| | |
|-----------------------------------------------------------------------------------|------------------------------------------------------|
|  | Be sure to read <i>Safety Precautions</i> on page 3. |
|-----------------------------------------------------------------------------------|------------------------------------------------------|

Ordering Information

Encoders [\[Refer to Dimensions on page 5.\]](#)

| Power supply voltage | Output configuration | Resolution (pulses/rotation) | Model |
|----------------------|---------------------------|------------------------------|----------------------------------|
| 12 to 24 VDC | Complementary output | 100, 200, 360, 500, 600 | E6F-CWZ5G (resolution) 2M |
| | | 1,000 | Example: E6F-CWZ5G (100P/R) 2M |
| | NPN open-collector output | 1,000 | E6F-CWZ5C (1000P/R) 2M |

Accessories (Order Separately) [\[Refer to Dimensions on page 5 for servo mounting bracket and to Accessories for coupling dimensions.\]](#)

| Name | Model | Remarks |
|------------------------|------------------|----------------------------|
| Couplings | E69-C10B | --- |
| | E69-C610B | Different end diameter |
| | E69-C10M | Metal construction |
| Servo Mounting Bracket | E69-2 | (Three brackets in a set.) |

Refer to *Accessories* for details.

Ratings and Specifications

| Item | Model | E6F-CWZ5G | E6F-CWZ5C |
|----------------------------------|--------|-------------------------------------------------------------------------------------------------------------------------------------------------------------------------|------------------------------------------------------------------------------------------------------------------------|
| Power supply voltage | | 12 VDC -10% to 24 VDC $+15\%$, ripple (p-p): 5% max. | |
| Current consumption*1 | | 100 mA max. | |
| Resolution (pulses/rotation) | | 100, 200, 360, 500, 600, 1,000 | 1,000 |
| Output configuration | | Complementary outputs*2 | NPN open-collector output |
| Output capacity | | Output voltage: $V_H = V_{CC} - 3 \text{ V min.}$ ($I_o = 30 \text{ mA}$), $V_L = 2 \text{ V max.}$ ($I_o = -30 \text{ mA}$) Output current: $\pm 30 \text{ mA}$ | Applied voltage: 30 VDC max. Sink current: 35 mA max. Residual voltage: 0.4 V max. (at sink current of 35 mA) |
| Maximum response frequency | | 83 kHz | |
| Phase difference between outputs | | $90^\circ \pm 45^\circ$ between A and B ($1/4 T \pm 1/8 T$) | |
| Rise and fall times of output | | 1 μs max. (Cable length: 2 m, Output current: 30 mA) | 1 μs max. (Cable length: 2 m, Control output voltage: 5 V, Load resistance: 1 k Ω) |
| Starting torque | | 10 mN·m max. at room temperature, 15 mN·m max. at low temperature | |
| Moment of inertia | | $3 \times 10^{-6} \text{ kg}\cdot\text{m}^2$ max.; $1.5 \times 10^{-6} \text{ kg}\cdot\text{m}^2$ max. at 600 P/R max. | |
| Shaft loading | Radial | 120 N | |
| | Thrust | 50 N | |
| Maximum permissible speed | | 5,000 r/min | |
| Protection circuits | | Power supply reverse polarity protection, Output load short-circuit protection | |
| Ambient temperature range | | Operating: -10 to 70°C (with no icing), Storage: -25 to 85°C (with no icing) | |
| Ambient humidity range | | Operating/Storage: 35% to 85% (with no condensation) | |
| Insulation resistance | | 20 M Ω min. (at 500 VDC) between current-carrying parts and case | |
| Dielectric strength | | 500 VAC, 50/60 Hz for 1 min between current-carrying parts and case | |
| Vibration resistance | | Destruction: 10 to 500 Hz, 150 m/s ² or 2-mm double amplitude for 11 min 3 times each in X, Y, and Z directions | |
| Shock resistance | | Destruction: 1,000 m/s ² 3 times each in X, Y, and Z directions | |
| Degree of protection | | IEC 60529 IP65, in-house standards: oilproof | |
| Connection method | | Pre-wired Models (Standard cable length: 2 m) | |
| Material | | Case: Zinc alloy, Main unit: Aluminum, Shaft: SUS420J2 | |
| Weight (packed state) | | Approx. 400 g | |
| Accessories | | Instruction manual Note: Coupling, mounting bracket and hex-head spanner are sold separately. | |

*1. An inrush current of approximately 9 A will flow for approximately 5 μs when the power is turned ON.

*2. Complementary Outputs

The complementary output has two output transistors (NPN and PNP) as shown at the right. These two output transistors alternately turn ON and OFF depending on the high or low output signal. When using them, pull up to the positive power supply voltage level or pull down to 0 V. The complementary output allows flow-in or flow-out of the output current and thus the rising and falling speeds of signals are fast. This allows a long cable distance. They can be connected to open-collector input devices (NPN, PNP).

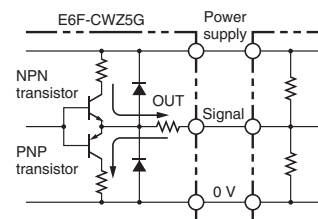

I/O Circuit Diagrams

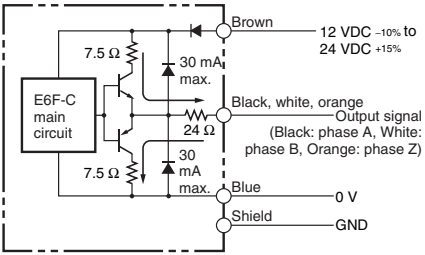
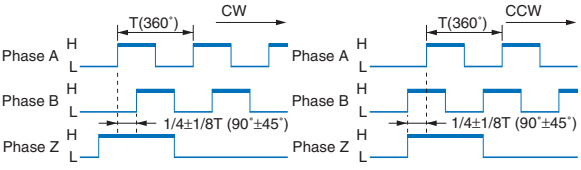
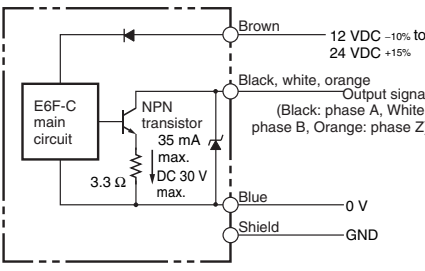
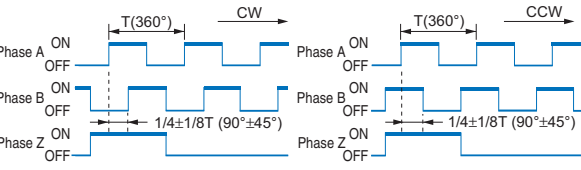
| Output Circuits | Output mode | Connection | | | | | | | | | | | | |
|-----------------------------------------------------------------------------------------------------------|---------------------------------------------------------------------------------------------------------------------------------------------------------------------------------------------------------------------------------------------------------------------------------------------------------------------------------------------------------------------------------------------------------------------------------------------------------------------------------------------------------|------------------------------------------------------------------------------------------------------------------------------------------------------------------------------------------------------------------------------------------------------------------------------------------------------------------------------------------------------------------------|-------|----------|-------|---------------------|-------|----------------|-------|----------------|--------|----------------|------|--------------|
| <p>E6F-CWZ5G</p>  | <p>Direction of rotation: CW (as viewed from end of shaft) Direction of rotation: CCW (as viewed from end of shaft)</p>  <p>Note: Phase A is $1/4 T \pm 1/8 T$ faster than phase B. Note: Phase A is $1/4 T \pm 1/8 T$ slower than phase B.</p> <p>("H" and "L" in the diagrams are the output voltage levels of phases A, B, and Z.)</p> | <table border="1"> <thead> <tr> <th>Color</th> <th>Terminal</th> </tr> </thead> <tbody> <tr> <td>Brown</td> <td>Power supply (+Vcc)</td> </tr> <tr> <td>Black</td> <td>Output phase A</td> </tr> <tr> <td>White</td> <td>Output phase B</td> </tr> <tr> <td>Orange</td> <td>Output phase Z</td> </tr> <tr> <td>Blue</td> <td>0 V (common)</td> </tr> </tbody> </table> | Color | Terminal | Brown | Power supply (+Vcc) | Black | Output phase A | White | Output phase B | Orange | Output phase Z | Blue | 0 V (common) |
| Color | Terminal | | | | | | | | | | | | | |
| Brown | Power supply (+Vcc) | | | | | | | | | | | | | |
| Black | Output phase A | | | | | | | | | | | | | |
| White | Output phase B | | | | | | | | | | | | | |
| Orange | Output phase Z | | | | | | | | | | | | | |
| Blue | 0 V (common) | | | | | | | | | | | | | |
| <p>E6F-CWZ5C</p>  | <p>Direction of rotation: CW (as viewed from end of shaft) Direction of rotation: CCW (as viewed from end of shaft)</p>  <p>Note: Phase A is $1/4 T \pm 1/8 T$ faster than phase B. Note: Phase A is $1/4 T \pm 1/8 T$ slower than phase B.</p> <p>(The ONs in the above timing chart mean that the output transistor is ON and the OFFs mean that the output transistor is OFF.)</p> | <table border="1"> <thead> <tr> <th>Color</th> <th>Terminal</th> </tr> </thead> <tbody> <tr> <td>Brown</td> <td>Power supply (+Vcc)</td> </tr> <tr> <td>Black</td> <td>Output phase A</td> </tr> <tr> <td>White</td> <td>Output phase B</td> </tr> <tr> <td>Orange</td> <td>Output phase Z</td> </tr> <tr> <td>Blue</td> <td>0 V (common)</td> </tr> </tbody> </table> | Color | Terminal | Brown | Power supply (+Vcc) | Black | Output phase A | White | Output phase B | Orange | Output phase Z | Blue | 0 V (common) |
| Color | Terminal | | | | | | | | | | | | | |
| Brown | Power supply (+Vcc) | | | | | | | | | | | | | |
| Black | Output phase A | | | | | | | | | | | | | |
| White | Output phase B | | | | | | | | | | | | | |
| Orange | Output phase Z | | | | | | | | | | | | | |
| Blue | 0 V (common) | | | | | | | | | | | | | |

Note: 1. The shielded cable outer core (shield) is not connected to the inner area or to the case.
 2. The phase A, phase B, and phase Z circuits are all identical.
 3. Normally, connect GND to 0 V or to an external ground.

Safety Precautions

Refer to *Warranty and Limitations of Liability*.

⚠ WARNING

This product is not designed or rated for ensuring safety of persons either directly or indirectly. Do not use it for such purposes.



Precautions for Correct Use

Do not use the Encoder under ambient conditions that exceed the ratings.

● Wiring

Cable Extension Characteristics

- When the cable length is extended, the output waveform startup time is lengthened and it affects the phase difference characteristics of phases A and B.
- * Recommended Cable
 - Conductor cross section: 0.2 mm²
 - Spiral shield
 - Conductor resistance: 92 Ω/km max. (20°C)
 - Insulation resistance: 5 Ω/km min. (20°C)
- The output waveform startup time changes not only according to the length of the cable, but also according to the load resistance and the cable type.
- Extending the cable length not only changes the startup time, but also increases the output residual voltage.

● Connection

- Spurious pulses may be generated when power is turned ON and OFF. Wait at least 0.1 s after turning ON the power to the Encoder before using the connected device, and stop using the connected device at least 0.1 s before turning OFF the power to the Encoder. Also, turn ON the power to the load only after turning ON the power to the Encoder.
- When the complementary output is used, the output will turn OFF when the load short-circuit protection circuit operates. To clear this condition, turn OFF the power supply, check the condition of the

Dimensions

Tolerance class IT16 applies to dimensions in this datasheet unless otherwise specified.

Encoder

E6F-CWZ5G

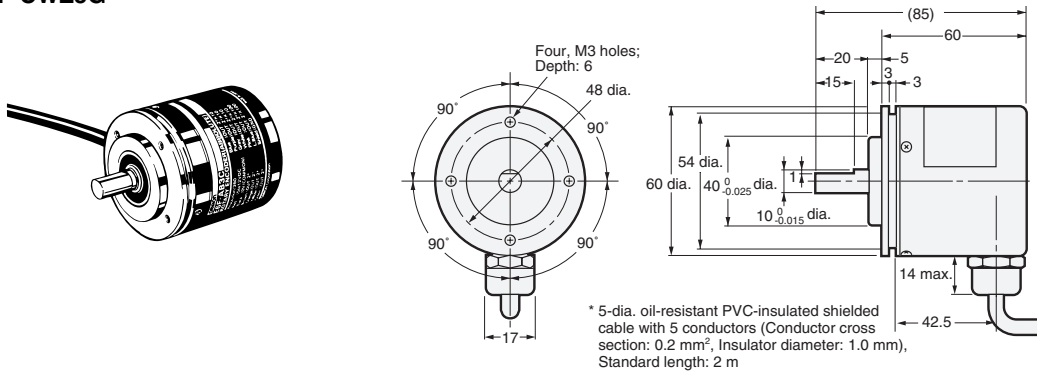

Accessories (Order Separately)

Servo Mounting Bracket

E69-2

Mounting Bracket Installation

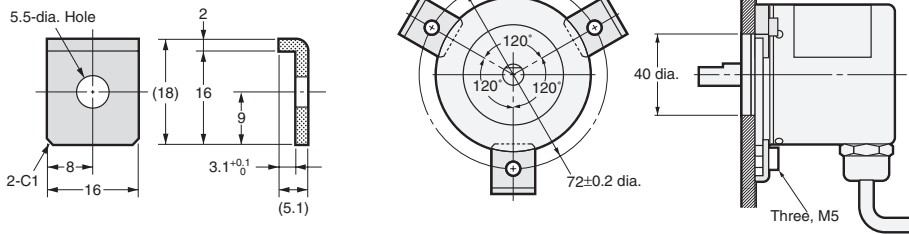

Couplings

E69-C10B

E69-C610B

E69-C10M

Refer to *Accessories* for details.

Terms and Conditions Agreement

Read and understand this catalog.

Please read and understand this catalog before purchasing the products. Please consult your OMRON representative if you have any questions or comments.

Warranties.

(a) Exclusive Warranty. Omron's exclusive warranty is that the Products will be free from defects in materials and workmanship for a period of twelve months from the date of sale by Omron (or such other period expressed in writing by Omron). Omron disclaims all other warranties, express or implied.

(b) Limitations. OMRON MAKES NO WARRANTY OR REPRESENTATION, EXPRESS OR IMPLIED, ABOUT NON-INFRINGEMENT, MERCHANTABILITY OR FITNESS FOR A PARTICULAR PURPOSE OF THE PRODUCTS. BUYER ACKNOWLEDGES THAT IT ALONE HAS DETERMINED THAT THE PRODUCTS WILL SUITABLY MEET THE REQUIREMENTS OF THEIR INTENDED USE.

Omron further disclaims all warranties and responsibility of any type for claims or expenses based on infringement by the Products or otherwise of any intellectual property right. (c) Buyer Remedy. Omron's sole obligation hereunder shall be, at Omron's election, to (i) replace (in the form originally shipped with Buyer responsible for labor charges for removal or replacement thereof) the non-complying Product, (ii) repair the non-complying Product, or (iii) repay or credit Buyer an amount equal to the purchase price of the non-complying Product; provided that in no event shall Omron be responsible for warranty, repair, indemnity or any other claims or expenses regarding the Products unless Omron's analysis confirms that the Products were properly handled, stored, installed and maintained and not subject to contamination, abuse, misuse or inappropriate modification. Return of any Products by Buyer must be approved in writing by Omron before shipment. Omron Companies shall not be liable for the suitability or unsuitability or the results from the use of Products in combination with any electrical or electronic components, circuits, system assemblies or any other materials or substances or environments. Any advice, recommendations or information given orally or in writing, are not to be construed as an amendment or addition to the above warranty.

See <http://www.omron.com/global/> or contact your Omron representative for published information.

Limitation on Liability; Etc.

OMRON COMPANIES SHALL NOT BE LIABLE FOR SPECIAL, INDIRECT, INCIDENTAL, OR CONSEQUENTIAL DAMAGES, LOSS OF PROFITS OR PRODUCTION OR COMMERCIAL LOSS IN ANY WAY CONNECTED WITH THE PRODUCTS, WHETHER SUCH CLAIM IS BASED IN CONTRACT, WARRANTY, NEGLIGENCE OR STRICT LIABILITY.

Further, in no event shall liability of Omron Companies exceed the individual price of the Product on which liability is asserted.

Suitability of Use.

Omron Companies shall not be responsible for conformity with any standards, codes or regulations which apply to the combination of the Product in the Buyer's application or use of the Product. At Buyer's request, Omron will provide applicable third party certification documents identifying ratings and limitations of use which apply to the Product. This information by itself is not sufficient for a complete determination of the suitability of the Product in combination with the end product, machine, system, or other application or use. Buyer shall be solely responsible for determining appropriateness of the particular Product with respect to Buyer's application, product or system. Buyer shall take application responsibility in all cases.

NEVER USE THE PRODUCT FOR AN APPLICATION INVOLVING SERIOUS RISK TO LIFE OR PROPERTY OR IN LARGE QUANTITIES WITHOUT ENSURING THAT THE SYSTEM AS A WHOLE HAS BEEN DESIGNED TO ADDRESS THE RISKS, AND THAT THE OMRON PRODUCT(S) IS PROPERLY RATED AND INSTALLED FOR THE INTENDED USE WITHIN THE OVERALL EQUIPMENT OR SYSTEM.

Programmable Products.

Omron Companies shall not be responsible for the user's programming of a programmable Product, or any consequence thereof.

Performance Data.

Data presented in Omron Company websites, catalogs and other materials is provided as a guide for the user in determining suitability and does not constitute a warranty. It may represent the result of Omron's test conditions, and the user must correlate it to actual application requirements. Actual performance is subject to the Omron's Warranty and Limitations of Liability.

Change in Specifications.

Product specifications and accessories may be changed at any time based on improvements and other reasons. It is our practice to change part numbers when published ratings or features are changed, or when significant construction changes are made. However, some specifications of the Product may be changed without any notice. When in doubt, special part numbers may be assigned to fix or establish key specifications for your application. Please consult with your Omron's representative at any time to confirm actual specifications of purchased Product.

Errors and Omissions.

Information presented by Omron Companies has been checked and is believed to be accurate; however, no responsibility is assumed for clerical, typographical or proofreading errors or omissions.

2015.9

In the interest of product improvement, specifications are subject to change without notice.

OMRON Corporation
Industrial Automation Company

<http://www.ia.omron.com/>

(c)Copyright OMRON Corporation 2015 All Right Reserved.