



Chipsmall Limited consists of a professional team with an average of over 10 year of expertise in the distribution of electronic components. Based in Hongkong, we have already established firm and mutual-benefit business relationships with customers from,Europe,America and south Asia,supplying obsolete and hard-to-find components to meet their specific needs.

With the principle of "Quality Parts,Customers Priority,Honest Operation,and Considerate Service",our business mainly focus on the distribution of electronic components. Line cards we deal with include Microchip,ALPS,ROHM,Xilinx,Pulse,ON,Everlight and Freescale. Main products comprise IC,Modules,Potentiometer,IC Socket,Relay,Connector.Our parts cover such applications as commercial,industrial, and automotives areas.

We are looking forward to setting up business relationship with you and hope to provide you with the best service and solution. Let us make a better world for our industry!



Contact us

Tel: +86-755-8981 8866 Fax: +86-755-8427 6832

Email & Skype: info@chipsmall.com Web: www.chipsmall.com

Address: A1208, Overseas Decoration Building, #122 Zhenhua RD., Futian, Shenzhen, China



SPECIFICATION

CUSTOMER : _____

MODULE NO.: EA TFT057-32ANN

<p style="text-align: center;">APPROVED BY:</p> <p>(FOR CUSTOMER USE ONLY)</p>	<p>PCB VERSION: _____</p> <p>DATA: _____</p>
---	--

SALES BY	APPROVED BY	CHECKED BY	PREPARED BY
ISSUED DATE: 2018/06/18			

Content

1. Summary
2. General Specification
3. Absolute Maximum Ratings
4. Electrical Characteristics
5. DC Characteristics
6. AC Characteristics
7. Optical Characteristics
8. Interface
9. Block Diagram
10. Reliability
11. Contour Drawing

1. Summary

This technical specification applies to 5.7' color TFT-LCD panel. The 5.7' color TFT-LCD panel is designed for camcorder, digital camera application and other electronic products which require high quality flat panel displays. This module follows RoHS.

1.1. Accessories

ZIF connector for display, bottom contact

ZIF connector for display, top contact

EA WF050-40S

EA WF050-40ST

2. General Specifications

Item	Dimension	Unit
Size	5.7	inch
Dot Matrix	320 x RGBx240(TFT)	dots
Module dimension	141.12(W) x 101.55(H) x 6.5(D)(MAX)	mm
Active area	115.2 x 86.40	mm
Dot pitch	0.12 x 0.36	mm
LCD type	TFT, Normally White, Transmissive	
View Direction	12 o'clock	
Gray Scale Inversion Direction	6 o'clock	
Backlight Type	LED, Normally White	
With /Without TP	Without TP	
Surface	Glare	

*Color tone slight changed by temperature and driving voltage.

3. Absolute Maximum Ratings

Item	Symbol	Min	Typ	Max	Unit
Operating Temperature	TOP	-20	—	+70	°C
Storage Temperature	TST	-30	—	+80	°C

Note: Device is subject to be damaged permanently if stresses beyond those absolute maximum ratings listed above

1. Temp. $\leq 60^{\circ}\text{C}$, 90% RH MAX. Temp. $> 60^{\circ}\text{C}$, Absolute humidity shall be less than 90% RH at 60°C

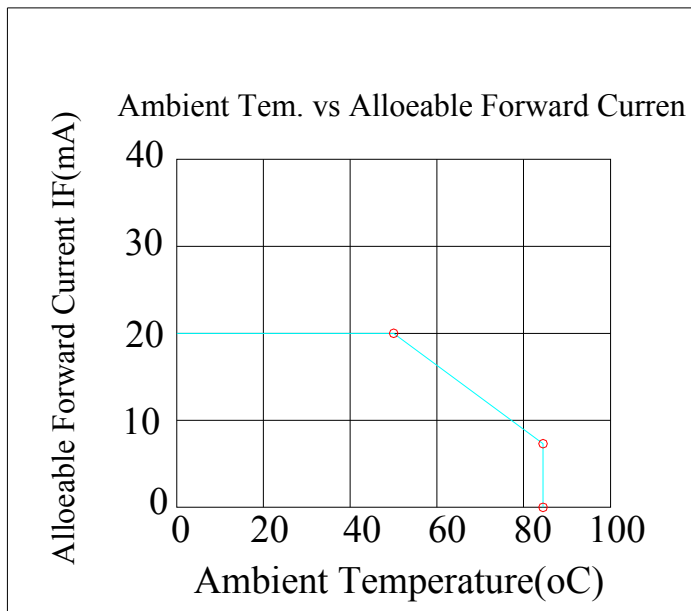

4. Electrical Characteristics

4.1. Operating conditions:

Item	Symbol	Condition	Min	Typ	Max	Unit
Supply Voltage For Logic	VCC	—	3.0	3.3	3.6	V
Supply Current	I _{cc}	VCC=3.3V	—	140	210	mA

4.2. LED driving conditions

Parameter	Symbol	Min.	Typ.	Max.	Unit	Remark
LED current		-	140	-	mA	
Power Consumption		1260		1470	mW	
LED voltage	VBL+	9.0		10.5	V	Note 1
LED Life Time			50,000		Hr	Note 2,3,4

Note 1 : There are 1 Groups LED

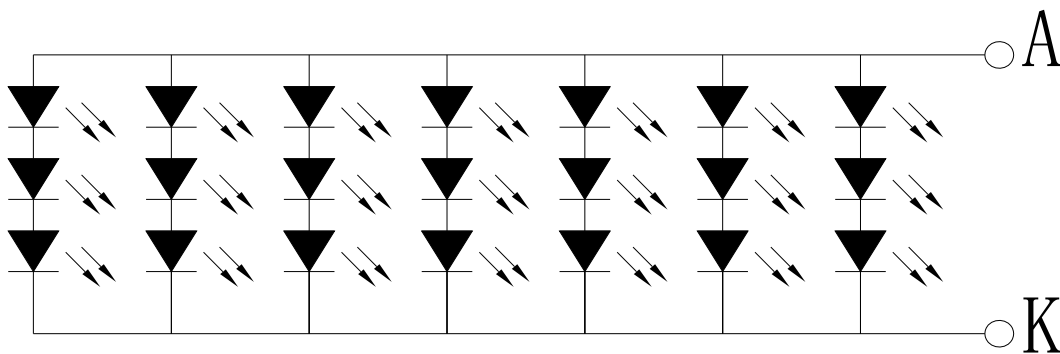

Note 2 : T_a = 25 °C

Note 3 : Brightness to be decreased to 50% of the initial value

Note 4 : The single LED lamp case.

5.DC CHARATERISTICS

Parameter	Symbol	Rating			Unit	Condition
		Min	Typ	Max		
Low level input voltage	V_{IL}	0	-	0.3VCC	V	
High level input voltage	V_{IH}	0.7VCC	-	VCC	V	

6.AC CHARATERISTICS

6.1. 24-bits parallel RGB Interface

AC Timing Characteristics

Signal	Item	Symbol	Min.	Typ.	Max.	Unit	
Dclk	Frequency	Dclk	-	6.4	-	MHZ	
	High time	Tch	-	78	-	ns	
	Low time	Tcl	-	78	-	ns	
Data	Setup time	Tds	12	-	-	ns	
	Hold time	Tdh	12	-	-	ns	
Hsync	Period	TH	-	408	-	DCLK	
	Pulse Width	Thp	-	30	-	DCLK	
	Back-Porch	Thb	-	38	-	DCLK	
	Display Period	Thd	-	320	-	DCLK	
	Front-Porch	Thf	-	20	-	DCLK	
Vsync	Period	NTSC	TV	-	262.5	-	DCLK
		PAL		312.5	-		
	Pulse Width		Tvp	1	3	5	TH
	Back-Porch	NTSC	Tvb	-	15	-	TH
		PAL		23	-		
	Display Period		Tvd	-	240	-	TH
	Front-Porch	NTSC	Tvf	-	4.5	-	TH
PAL		46.5		-			

AC Timing Diagrams

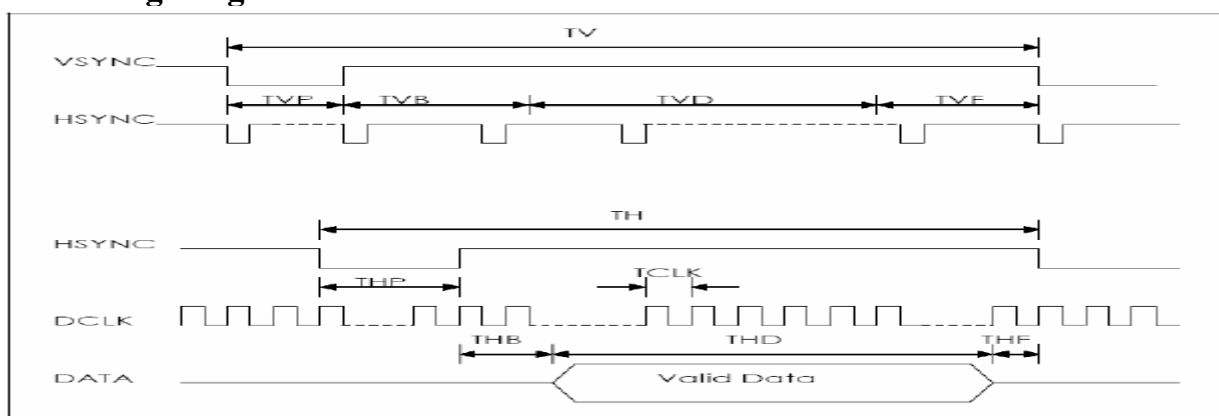

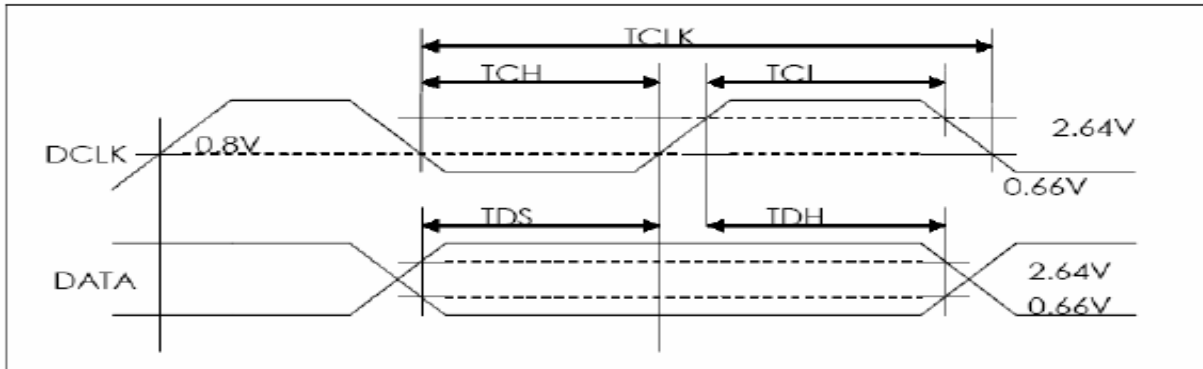

7. Optical Characteristics

Item	Symbol	Condition.	Min	Typ.	Max.	Unit	Remark	
Response time	Tr	$\theta=0^\circ$ 、 $\Phi=0^\circ$	-	15	30	.ms	Note 3,5	
	Tf		-	35	50	.ms		
Contrast ratio	CR	At optimized viewing angle	150	250	-	-	Note 4,5	
Color Chromaticity	White	$\theta=0^\circ$ 、 $\Phi=0^\circ$	Wx	0.282	0.312	0.342		Note 2,6,7
			Wy	0.319	0.349	0.379		
Viewing angle (Gray Scale Inversion Direction)	Hor.	$CR \geq 10$	Θ_R	60	70		Deg.	Note 1
			Θ_L	60	70			
	Ver.		Φ_T	40	50			
			Φ_B	60	70			
Brightness	-	-	400	500		cd/m ²	Center of display	

Ta=25±2°C, IL=140mA

Note 1: Definition of viewing angle range

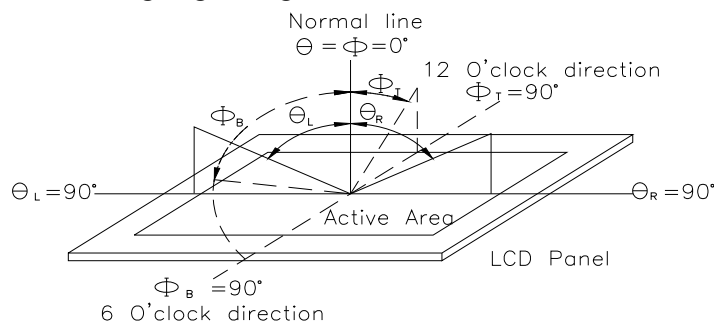

Fig.8.1. Definition of viewing angle

Note 2: Test equipment setup:

After stabilizing and leaving the panel alone at a driven temperature for 10 minutes, the measurement should be executed. Measurement should be executed in a stable, windless, and dark room. Optical specifications are measured by Topcon BM-7orBM-5 luminance meter 1.0° field of view at a distance of 50cm and normal direction.

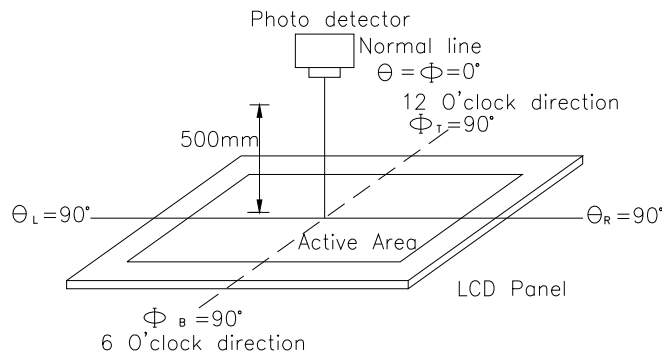
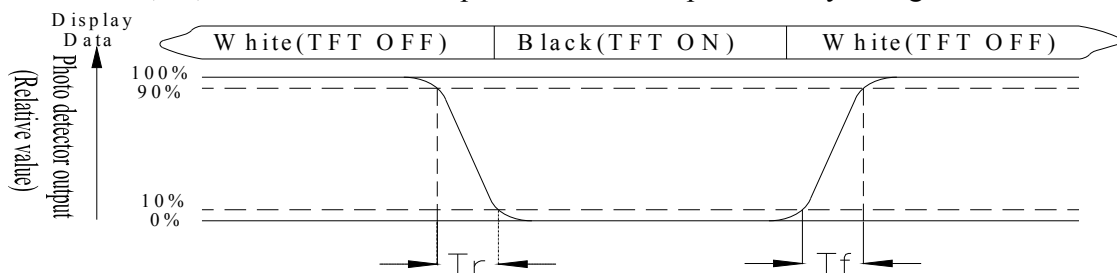

Fig. 8.2. Optical measurement system setup

Note 3: Definition of Response time:

The response time is defined as the LCD optical switching time interval between “White” state and “Black” state. Rise time, T_r , is the time between photo detector output intensity changed from 90% to 10%. And fall time, T_f , is the time between photo detector output intensity changed from 10% to 90%



Note 4: Definition of contrast ratio:

The contrast ratio is defined as the following expression.

$$\text{Contrast ratio (CR)} = \frac{\text{Luminance measured when LCD on the "White" state}}{\text{Luminance measured when LCD on the "Black" state}}$$

Note 5: White $V_i = V_{i50} \pm 1.5V$

Black $V_i = V_{i50} \pm 2.0V$

“±” means that the analog input signal swings in phase with VCOM signal.

“±” means that the analog input signal swings out of phase with VCOM signal.

The 100% transmission is defined as the transmission of LCD panel when all the input terminals of module are electrically opened.

Note 6: Definition of color chromaticity (CIE 1931)

Color coordinates measured at the center point of LCD

Note 7: Measured at the center area of the panel when all the input terminals of LCD panel are electrically opened.

8.Interface

8.1. LCM PIN Definition

Pin	Symbol	Function	Remark
1	NC	No connection	
2	NC	No connection	
3	GND	System ground pin of the IC. Connect to system ground.	
4	VCC	Power Supply	
5	R0	Red Data bit(LSB)	
6	R1	Red Data bit	
7	R2	Red Data bit	
8	R3	Red Data bit	
9	R4	Red Data bit	
10	R5	Red Data bit	
11	R6	Red Data bit	
12	R7	Red Data bit (MSB)	
13	G0	Green Data bit(LSB)	
14	G1	Green Data bit	
15	G2	Green Data bit	
16	G3	Green Data bit	
17	G4	Green Data bit	
18	G5	Green Data bit	
19	G6	Green Data bit	
20	G7	Green Data bit (MSB)	
21	B0	Blue Data bit(LSB)	
22	B1	Blue Data bit	
23	B2	Blue Data bit	
24	B3	Blue Data bit	
25	B4	Blue Data bit	
26	B5	Blue Data bit	
27	B6	Blue Data bit	
28	B7	Blue Data bit (MSB)	
29	GND	System ground pin of the IC. Connect to system ground.	
30	CLK	Dot data clock	
31	L/R	Shift direction of device internal shift register control.	Note2,3
32	Hsync	Horizontal sync signal	Note1
33	Vsync	Vertical sync signal	Note1
34	DE	Data Enable signal	Note1
35	U/D	Up/down selection	Note2,3
36	RESET	Hardware reset	
37	NC	No connection	
38	NC	No connection	
39	NC	No connection	
40	NC	No connection	

For digital 24Bit RGB input data format, both SYNC mode and DE mode are supported. If DE signal is fixed low, SYNC mode is used. Otherwise, DE mode is used. Suggest used SYNC mode!!

Mode	D[23:16]	D[15:8]	D[7:0]	IHS	IVS	DEN
24 bit RGB	R[7:0]	G[7:0]	B[7:0]	HSYNC	VSYNC	DE signal is fixed low for SYNC mode
				Floating if not used	Floating if not used	DE for DE Mode

Note 2: Selection of scanning mode

Setting of scan control input		Scanning direction
U/D	L/R	
GND	VCC	Up to down, left to right
VCC	GND	Down to up, right to left
GND	GND	Up to down, right to left
VCC	VCC	Down to up, left to right

Note 3: Definition of scanning direction. Refer to the figure as below:

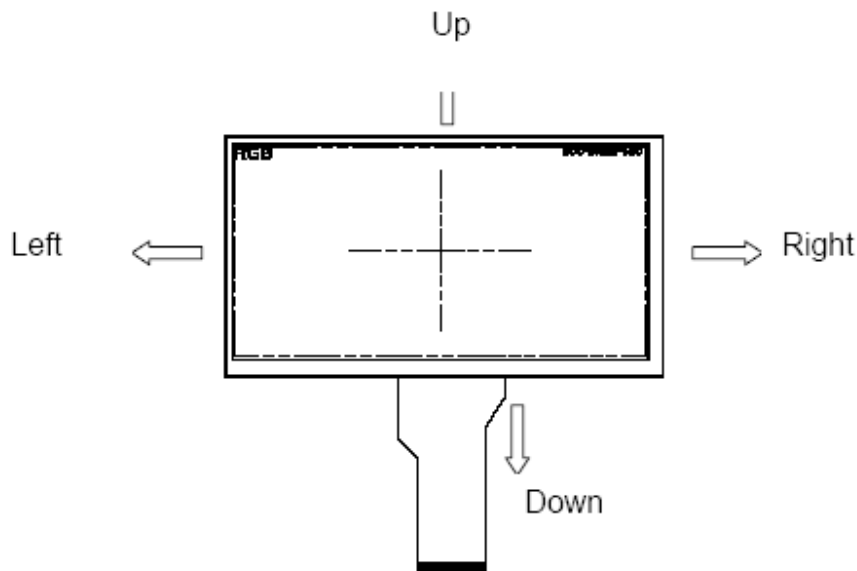

9. Block Diagram

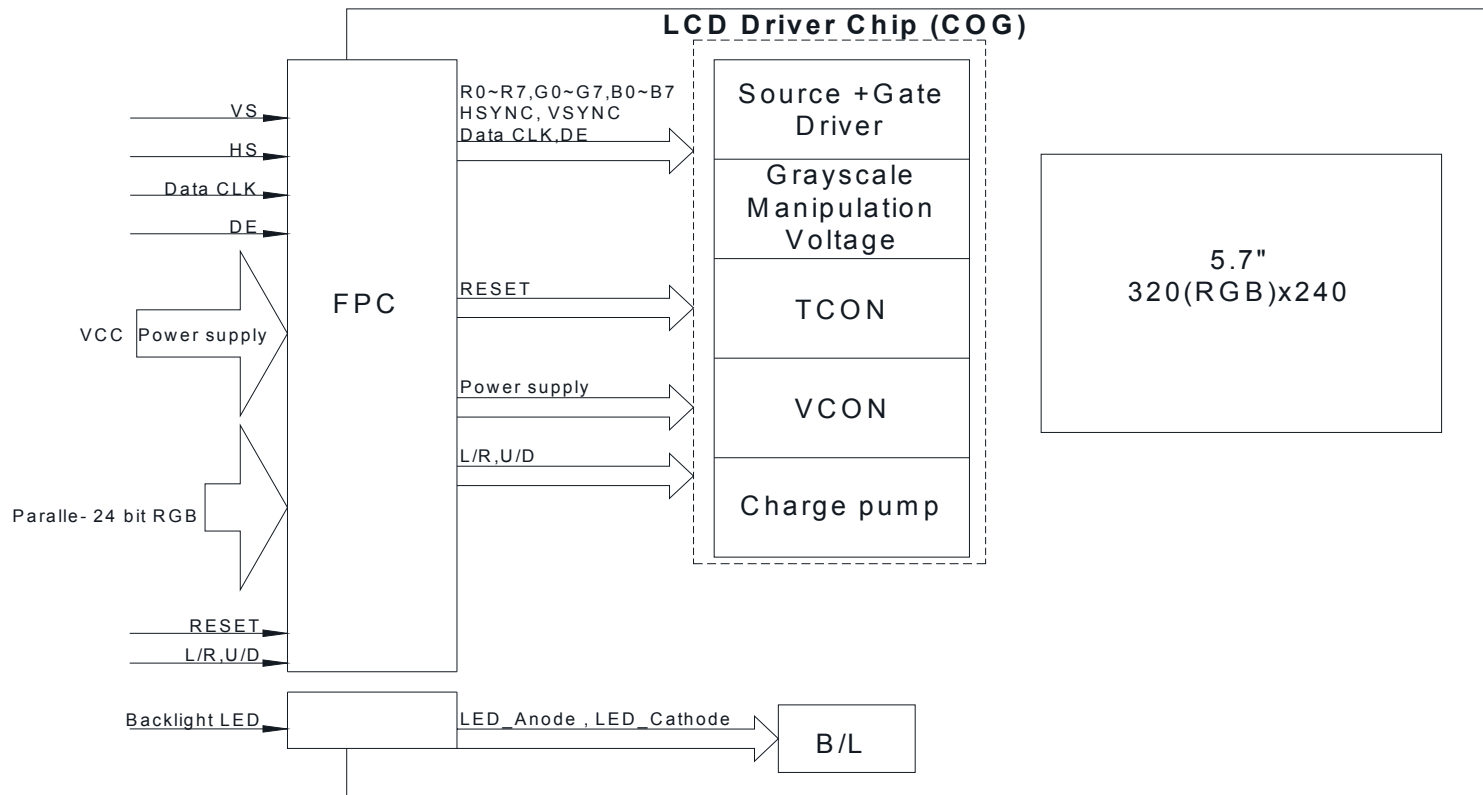

10. Reliability

Content of Reliability Test (Wide temperature, -20°C~70°C)

Environmental Test			
Test Item	Content of Test	Test Condition	Note
High Temperature storage	Endurance test applying the high storage temperature for a long time.	80°C 200hrs	2
Low Temperature storage	Endurance test applying the low storage temperature for a long time.	-30°C 200hrs	1,2
High Temperature Operation	Endurance test applying the electric stress (Voltage & Current) and the thermal stress to the element for a long time.	70°C 200hrs	—
Low Temperature Operation	Endurance test applying the electric stress under low temperature for a long time.	-20°C 200hrs	1
High Temperature/ Humidity Operation	The module should be allowed to stand at 60°C, 90%RH max	60°C, 90%RH 96hrs	1,2
Thermal shock resistance	The sample should be allowed stand the following 10 cycles of operation <div style="text-align: center;"> <p style="margin: 0;">-20°C 25°C 70°C</p> <p style="margin: 0;">30min 5min 30min</p> <p style="margin: 0;">1 cycle</p> </div>	-20°C/70°C 10 cycles	—
Vibration test	Endurance test applying the vibration during transportation and using.	Total fixed amplitude : 15mm Vibration Frequency : 10~55Hz One cycle 60 seconds to 3 directions of X,Y,Z for Each 15 minutes	3
Static electricity test	Endurance test applying the electric stress to the terminal.	VS=±600V(contact), ±800v(air), RS=330Ω CS=150pF 10 times	—

Note1: No dew condensation to be observed.

Note2: The function test shall be conducted after 4 hours storage at the normal Temperature and humidity after remove from the test chamber.

Note3: The packing have to including into the vibration testing.

11. Contour Drawing

