



Chipsmall Limited consists of a professional team with an average of over 10 year of expertise in the distribution of electronic components. Based in Hongkong, we have already established firm and mutual-benefit business relationships with customers from,Europe,America and south Asia,supplying obsolete and hard-to-find components to meet their specific needs.

With the principle of “Quality Parts,Customers Priority,Honest Operation,and Considerate Service”,our business mainly focus on the distribution of electronic components. Line cards we deal with include Microchip,ALPS,ROHM,Xilinx,Pulse,ON,Everlight and Freescale. Main products comprise IC,Modules,Potentiometer,IC Socket,Relay,Connector.Our parts cover such applications as commercial,industrial, and automotives areas.

We are looking forward to setting up business relationship with you and hope to provide you with the best service and solution. Let us make a better world for our industry!



Contact us

Tel: +86-755-8981 8866 Fax: +86-755-8427 6832

Email & Skype: info@chipsmall.com Web: www.chipsmall.com

Address: A1208, Overseas Decoration Building, #122 Zhenhua RD., Futian, Shenzhen, China



5V/9V/12V Output QC2.0+USB Auto Detect+USB-PD Type-C Application Report

ACT4529

FEATURES

- Wide input voltage range from 6V to 32V
- Transparent input voltage surge up to 40V
- QC2.0 decoding, 5V/9V/12V output voltage regulation
- USB auto detect, support Apple, Samsung and BC 1.2
- Interface for USB-PD Type-C output voltage control 5V/9V/12V
- 2.4A output with Constant current regulation
- 125kHz switching frequency
- Standby input current <1mA
- Good EMC performance
- Under voltage protection at output short
- <6mA average output current at output short
- Output over voltage protection
- Output cord compensation
- Thermal shutdown protection

SPECIFICATION

DESCRIPTION	CONDITION	MIN	TYP	MAX	UNITS
Output current limit range		2400	2650	2900	mA
Ripple Voltage	Vin=12V,ouput 5V/2.4A		46		mVpp
	Vin=12V,ouput 9V/2.4A		27		
	Vin=12V,ouput 11.6V/2.4A		19		
	Vin=24V,ouput 5V/2.4A		59		
	Vin=24V,ouput 9V/2.4A		72		
	Vin=24V,ouput 12V/2.4A		80		
Efficiency at full load	Vin=12V,ouput 5V/2.4A		89.6		%
	Vin=12V,ouput 9V/2.4A		94.9		
	Vin=12V,ouput 12V/2.4A		96.7		
	Vin=24V,ouput 5V/2.4A		87.7		
	Vin=24V,ouput 9V/2.4A		92.4		
	Vin=24V,ouput 12V/2.4A		93.9		
ENVIRONMENTAL					
ESD	Contact		8		kV
	Through air		15		kV

TABLE OF CONTENTS

1. Demo Board Photo	3
2. PCB Layout	3
3. Schematic.....	3
4. Bill of Materials.....	4
5. Functional Test.....	5
5.1. Output Regulation (on PCB board)	5
5.2. Efficiency (Ta=25°C).....	6
5.3. Power Loss	7
5.4. Constant Current and Constant Voltage (Ta=25°C).....	9
5.5. Standby Input Current.....	12
5.6. Ripple and Noise	13
5.7. Load Dynamic Response	15
5.8. Output Voltage Transient	16
5.9. Line Dynamic Response(Vin change from 12V to 40V, 0.1V/us).....	17
5.10. Key Components Temperature Test (burning for 2 hours)	18
6. EMI TEST.....	19
6.1. Output 5V	19
6.2. Output=9V.....	20

1. DEMO BOARD PHOTO

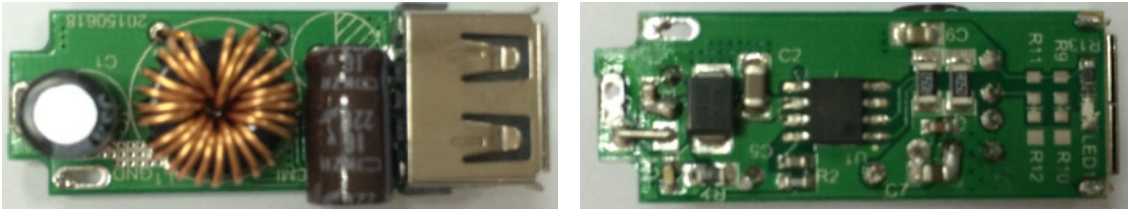

2. PCB LAYOUT

PCB SIZE: 39.4mm*15.0mm

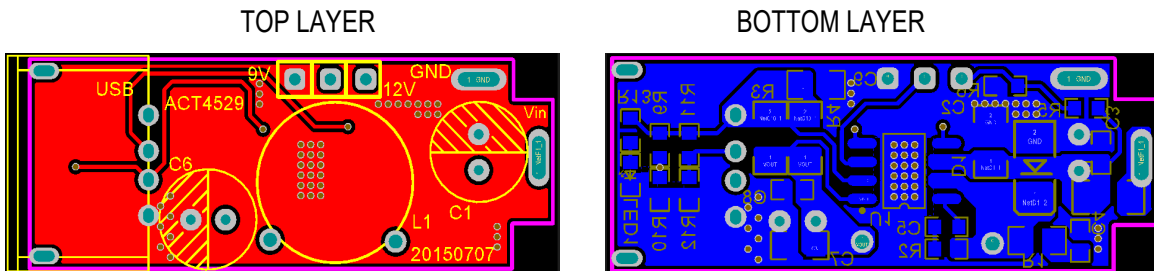

3. SCHEMATIC

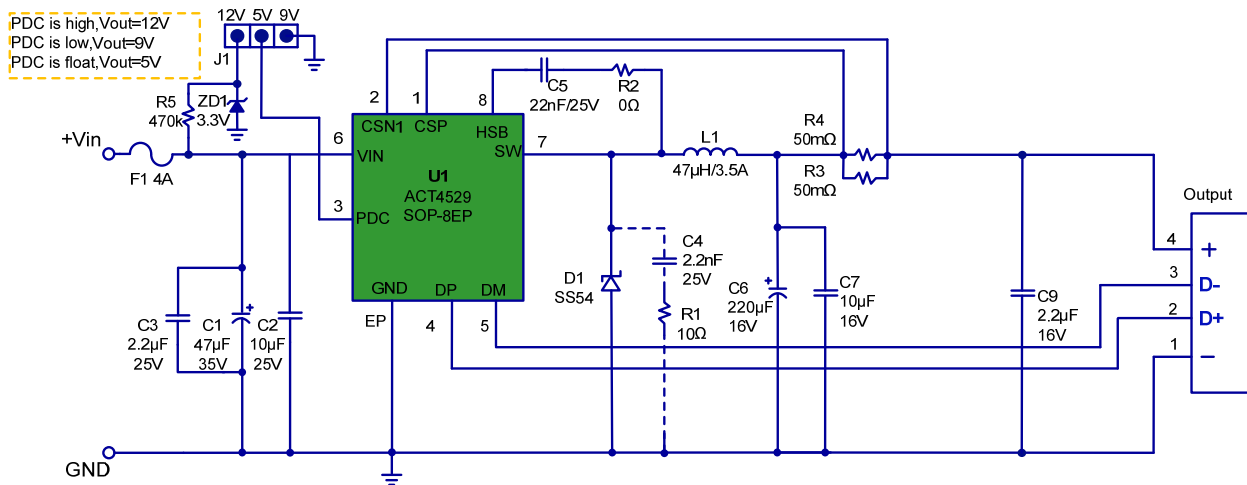

4. BILL OF MATERIALS

Item	Reference	Description	QTY	Manuf.
1	L1	Choke Coil, Dip,T9*5*4mm, phi=0.6mm, L=47uH	1	
2	D1	Schottky Diode, SK54BL, 40V/5A, SMB	1	Panjit
3	C1	Electrolytic capacitor, 47uF/35V, 6.3x8mm	1	Koshin
4	C2	Ceramic capacitor, 10uF/35V, X7R, 1206	1	Murata/TDK
5	C3	Ceramic capacitor, 2.2uF/35V, X7R, 0805	1	Murata/TDK
6	C4	Ceramic capacitor, 2.2nF/25V, X7R, 0603(optional)	1	Murata/TDK
7	C5	Ceramic capacitor, 22nF/25V, X7R, 0603	1	Murata/TDK
8	C6	Electrolytic capacitor, 220uF/16V, 7x11.5mm	1	Koshin
9	C7	Ceramic capacitor, 10uF/16V, X7R, 0805	1	Murata/TDK
10	C9	Ceramic capacitor, 2.2uF/16V, X7R, 0603	1	Murata/TDK
11	F1	Fuse, 3A, 1206 (Replaced by 0Ω 0805 chip resistor)	1	Murata/TDK
12	R1	Chip Resistor, 5.1Ω, 1/8W, 5%, 0805(optional)	1	Murata/TDK
13	R2	Chip Resistor, 0Ω, 1/10W, 5%, 0603	1	Murata/TDK
14	R3/R4	Chip Resistor, 50mΩ, 1/4W, 1%, 1206	2	Murata/TDK
15	R5	Chip Resistor, 470K, 1/10W, 5%, 0603	1	Murata/TDK
16	ZD1	Zener diode,MMSZ5226BS,3.3V,SOD-323	1	Panjit
17	U1	IC, ACT4528, SOP-8-EP	1	ACT
18	USB	USB Rev: A	1	

5. FUNCTIONAL TEST

5.1. Output Regulation (on PCB board)

Vout=5V (With cord compensation)

VIN	Minimum Output Voltage(V)	Maximum Output Voltage(V)	Load Regulation	Iload
10V	5.09	5.22	2.5%	0A-2.4A
12V	5.09	5.22	2.5%	
16V	5.09	5.22	2.5%	
24V	5.09	5.022	2.5%	

Vout=9V(With cord compensation)

VIN	Minimum Output Voltage(V)	Maximum Output Voltage(V)	Load Regulation	Iload
10V	9.21	9.34	1.4%	0A-2.4A
12V	9.21	9.21	1.4%	
16V	9.21	9.34	1.4%	
24V	9.21	9.34	1.4%	

Vout=12V(With cord compensation)

VIN	Minimum Output Voltage(V)	Maximum Output Voltage(V)	Load Regulation	Iload
10V	9.61	10.05	4.5%	0A-2.4A
12V	11.56	11.91	3.0%	
16V	12.19	12.32	1.1%	
24V	12.19	12.32	1.1%	

5.2. Efficiency (Ta=25°C)

VIN	Vout=5V Efficiency (%)				
	Io=100mA	Io=1000mA	Io=1500mA	Io=2000mA	Io=2400mA
10V	88.94	93.12	92.14	91.15	90.04
12V	86.30	92.11	91.46	90.43	89.55
16V	83.16	90.69	90.43	89.44	88.96
24V	75.49	88.72	88.70	88.44	87.73

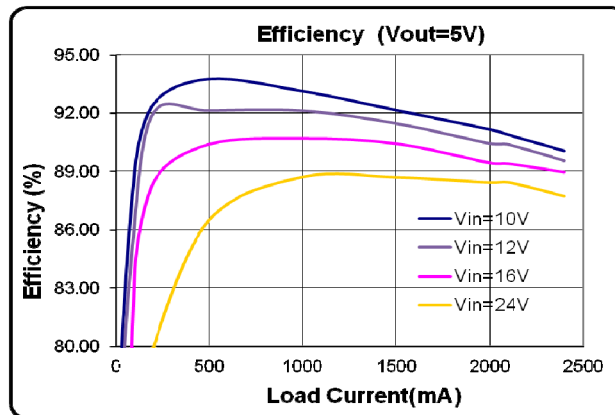

VIN	Vout=9V Efficiency (%)				
	Io=100mA	Io=1000mA	Io=1500mA	Io=2000mA	Io=2400mA
10V	94.72	97.48	96.83	96.25	95.39
12V	93.70	96.68	96.15	95.43	94.91
16V	89.93	94.88	94.55	93.89	93.56
24V	89.23	92.80	92.89	92.68	92.39

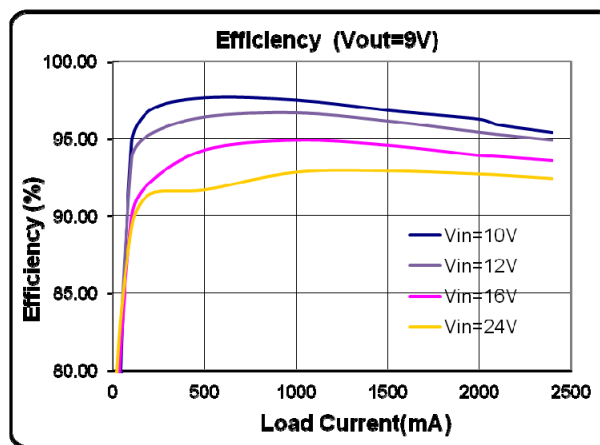

VIN	Vout=12V Efficiency (%)				
	Io=100mA	Io=1000mA	Io=1500mA	Io=2000mA	Io=2400mA
12V	97.94	98.31	97.73	97.11	96.66
16V	92.91	96.72	96.34	95.97	95.60
24V	90.74	94.33	94.52	94.30	93.90

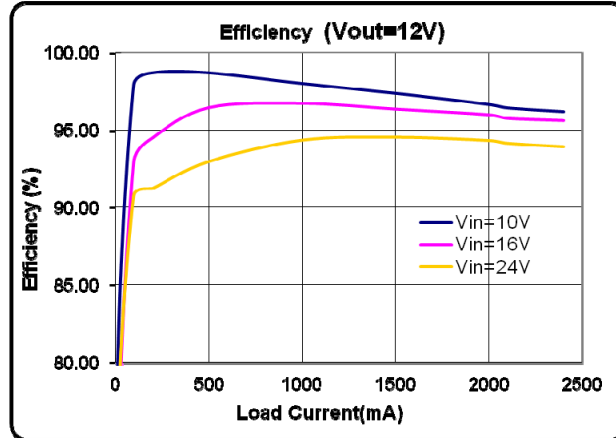

5.3. Power Loss

Vin	Vout=5V Power loss (W)					
	Io=0mA	Io=100mA	Io=1000mA	Io=1500mA	Io=2000mA	Io=2400mA
Vin=10V	0.01	0.06	0.38	0.66	1.01	1.39
Vin=12V	0.01	0.08	0.44	0.72	1.1	1.46
Vin=16V	0.02	0.10	0.53	0.82	1.23	1.56
Vin=24V	0.02	0.17	0.65	0.99	1.36	1.75

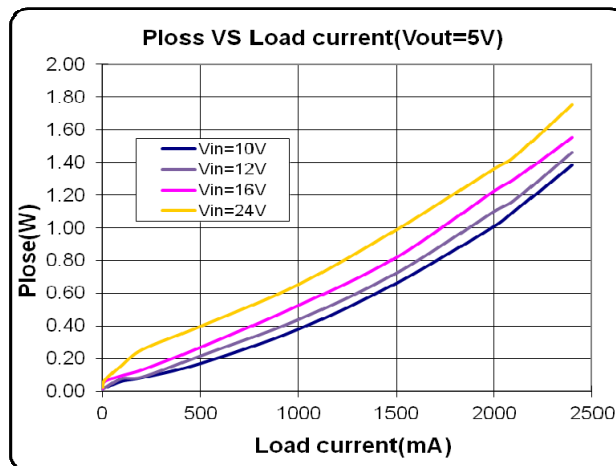

Vin	Vout=9V Power loss (W)
-----	------------------------

	Io=0mA	Io=100mA	Io=1000mA	Io=1500mA	Io=2000mA	Io=2400mA
Vin=10V	0.05	0.05	0.24	0.46	0.73	1.08
Vin=12V	0.02	0.06	0.32	0.56	0.89	1.2
Vin=16V	0.03	0.10	0.50	0.80	1.21	1.54
Vin=24V	0.02	0.11	0.72	1.07	1.47	1.85

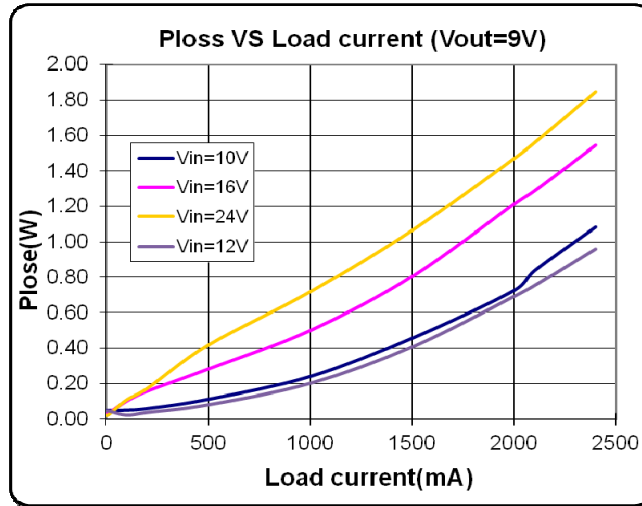

Vin	Vout=12V Power loss (W)					
	Io=0mA	Io=100mA	Io=1000mA	Io=1500mA	Io=2000mA	Io=2400mA
Vin=12V	0.04	0.03	0.20	0.41	0.69	0.96
Vin=16V	0.05	0.09	0.42	0.70	1.03	1.36
Vin=24V	0.05	0.12	0.74	1.07	1.49	1.92

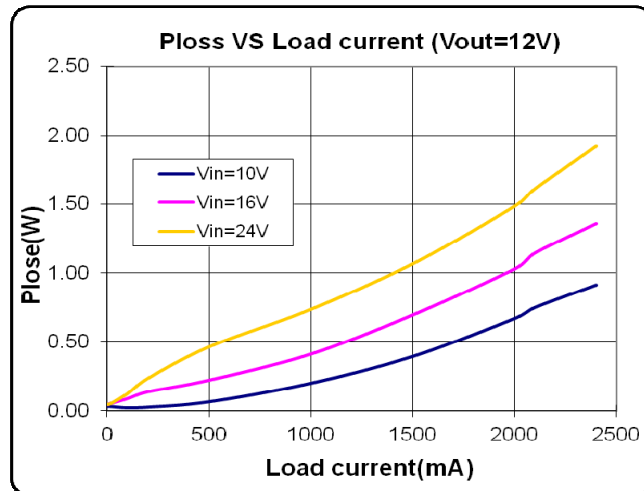

5.4. Constant Current and Constant Voltage (Ta=25°C)

Vout=5V	Vin=12V		Vin=16V		Vin=24V	
	Vout (V)	Iout(mA)	Vout (V)	Iout (mA)	Vout (V)	Iout (mA)
CC Load	5.09	0	5.09	0	5.09	0
	5.12	500	5.12	100	5.12	100
	5.14	1000	5.14	1000	5.14	1000
	5.17	2000	5.17	2000	5.17	2000
	5.22	2400	5.22	2400	5.22	2400
CV Load	4.95	2537	4.85	2536	4.85	2533
	4.8	2537	4.75	2536	4.75	2533
	4.5	2537	4.5	2536	4.5	2533
	4	2537	4	2536	4	2533
	3.5	2537	3.5	2537	3.5	2533
	3	2538	3	2537	3	2533
	2.8	2538	2.5	2537	2.5	2533
	2.6	2212	2.4	2240	2.4	2340
	2.5	0	2.5	0	2.5	0

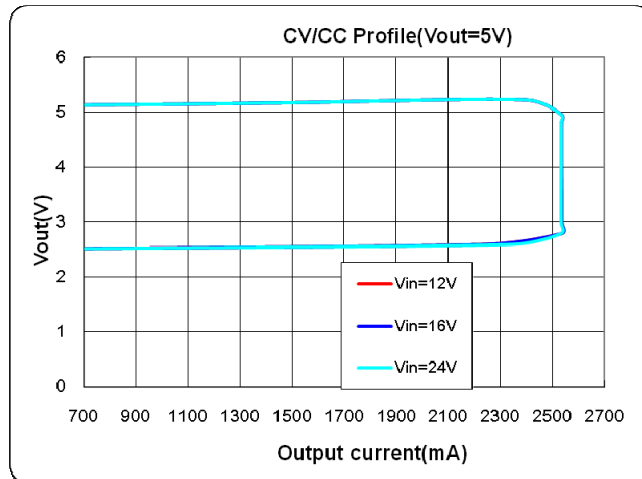

Vout=9V	Vin=12V		Vin=16V		Vin=24V	
	Vout (V)	Iout(mA)	Vout (V)	Iout (mA)	Vout (V)	Iout (mA)
CC Load	9.21	0	9.21	0	9.21	0
	9.24	500	9.24	500	9.24	500
	9.27	1000	9.27	1000	9.27	1000
	9.3	2000	9.3	2000	9.3	2000
	9.34	2400	9.34	2400	9.34	2400
CV Load	9	2542	9	2535	9	2529
	8	2543	8	2535	8	2529
	7	2543	7	2535	7	2529
	6	2544	6	2535	6	2555
	5	2544	5	2535	5	2548
	4	2544	4	2547	4	2610
	3	2543	3	2535	3	2525
	2.5	0	2.5	0	2.5	0

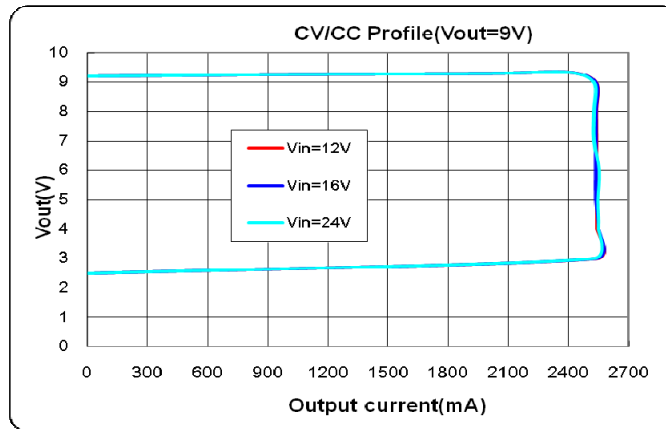

Vout=12V	Vin=12V		Vin=16V		Vin=24V	
	Vout (V)	Iout(mA)	Vout (V)	Iout (mA)	Vout (V)	Iout (mA)
CC Load	12.19	0	12.19	0	12.19	0
	12.22	500	12.22	500	12.22	500
	12.24	1000	12.24	1000	12.24	1000
	12.3	1500	12.3	1500	12.3	1500
	12.32	2400	12.32	2400	12.32	2400
CV Load	11	2538	11.5	2533	12	2530
	10	2538	10	2533	10	2530
	9	2539	9	2534	9	2530
	8	2539	8	2534	8	2530
	7	2540	7	2534	7	2545
	6	2541	6	2535	6	2545
	5	2540	5	2557	5	2540
	4	2541	4	2625	4	2642
	3	2540	3	2530	3	2521
2.5	0	2.5	0	2.5	0	

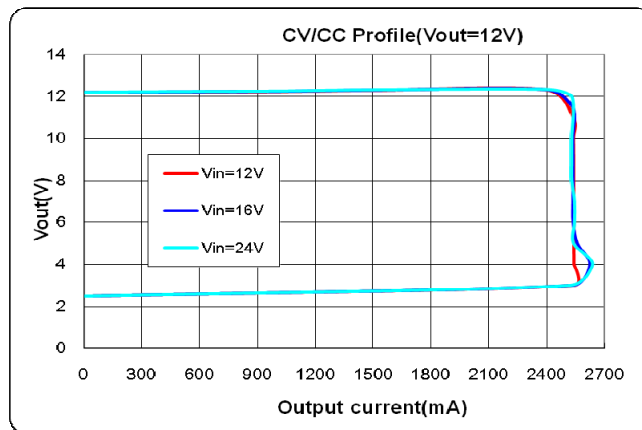

5.5. Standby Input Current

Vout=5V

Test Conditions	Input Current (mA)	Power Loss at No Load (mW)
Vin=10V	0.75	7.5
Vin=12V	0.7	8.4
Vin=16V	0.84	13.4
Vin=24V	0.69	16.6

Vout=9V

Test Conditions	Input Current (mA)	Power Loss at No Load (mW)
Vin=10V	3.94	39.4
Vin=12V	1.69	20.3
Vin=16V	1.35	21.6
Vin=24V	1.06	25.4

Vout=12V

Test Conditions	Input Current (mA)	Power Loss at No Load (mW)
Vin=12V	2.13	25.6
Vin=16V	2.13	34.1
Vin=24V	1.56	37.4

5.6. Ripple and Noise

CH1:Vsw, CH2:Vout2

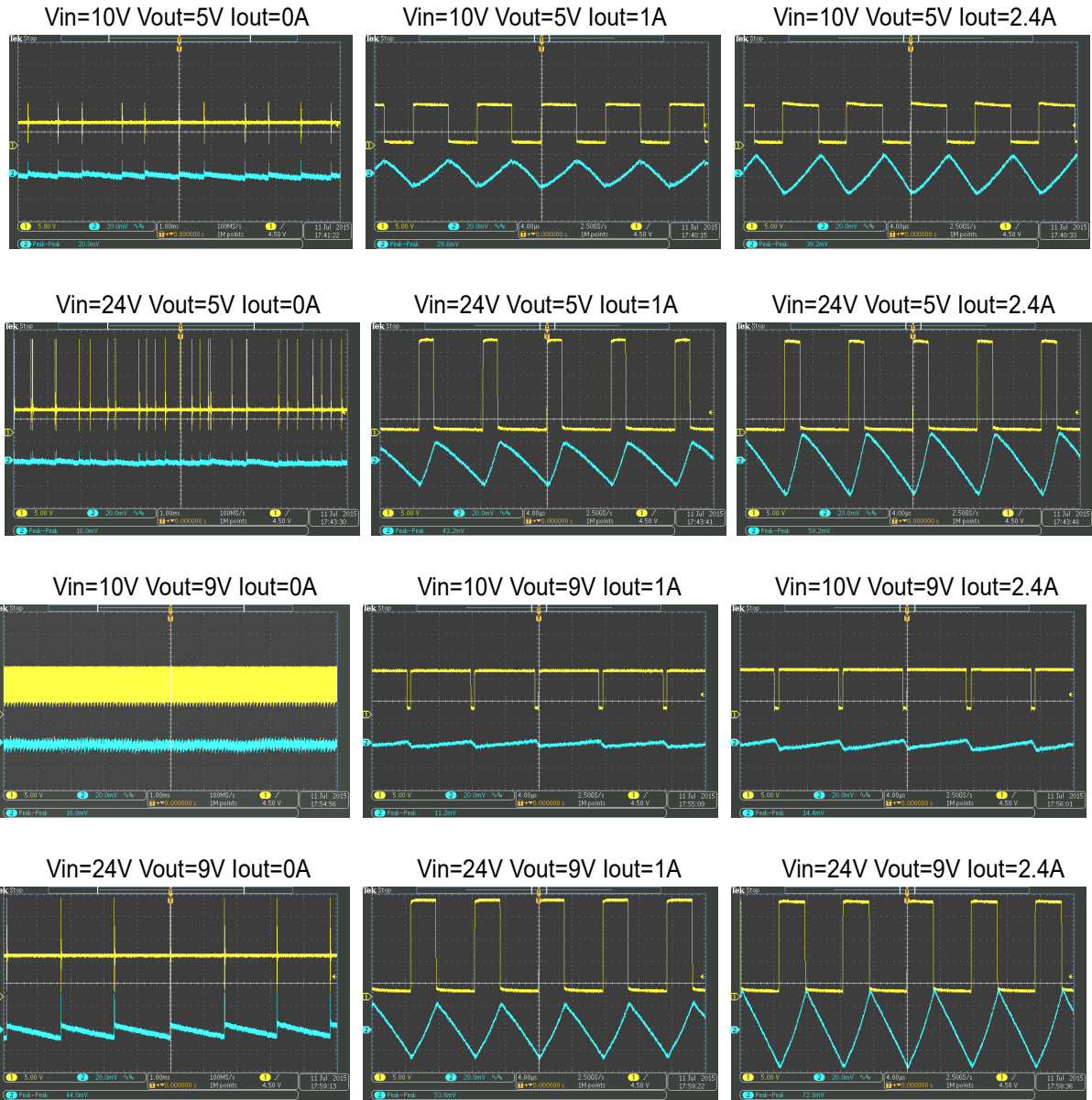

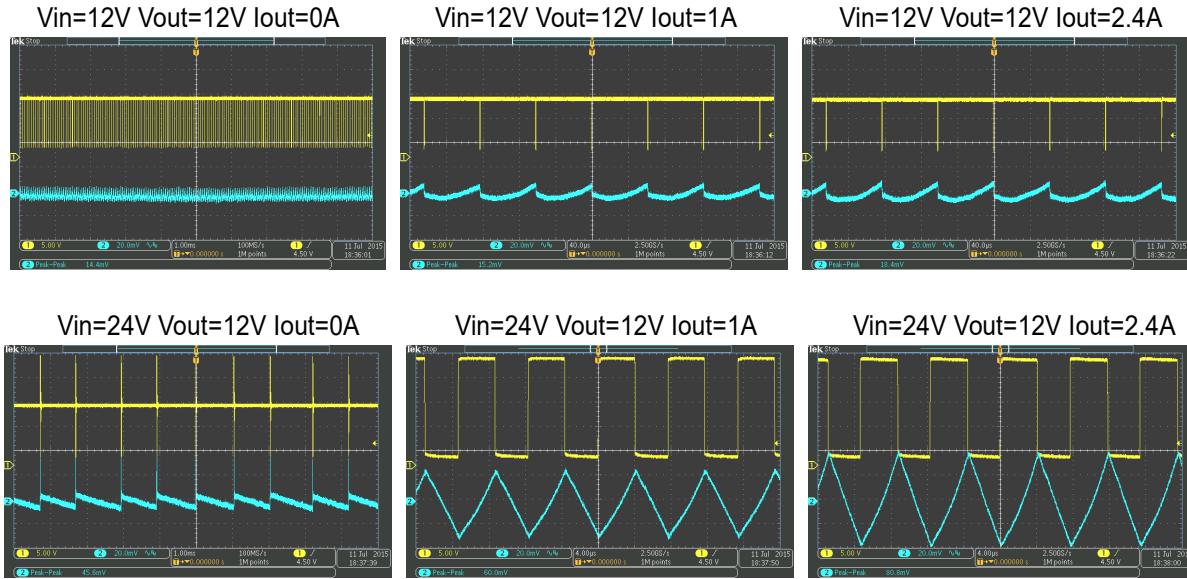

Ripple & noise are measured by using 20MHz bandwidth limited oscilloscope

Test Conditions	Vout=5V			Vout=9V			Vout=12V		
	Iout=0A	Iout=1A	Iout=2.4A	Iout=0A	Iout=1A	Iout=2.4A	Iout=0A	Iout=1A	Iout=2.4A
Vin=10V	20	30	39	16	11	14	13	14	17
Vin=12V	25	34	46	15	21	27	11	15	18
Vin=16V	34	38	52	22	38	51	21	30	38
Vin=24V	36	43	59	44	54	73	46	60	80

5.7. Load Dynamic Response

CH2:Vout ripple, CH4:Iout

Vout=5V

Vin=24V, load step 0A-0.5A-0A

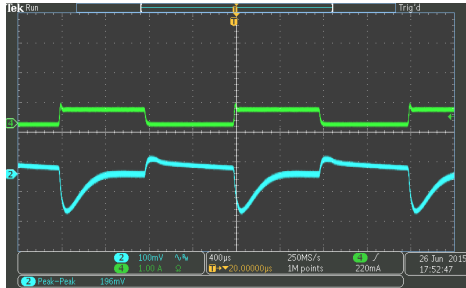

Vin=24V, load step 0.5A-1A-0.5A

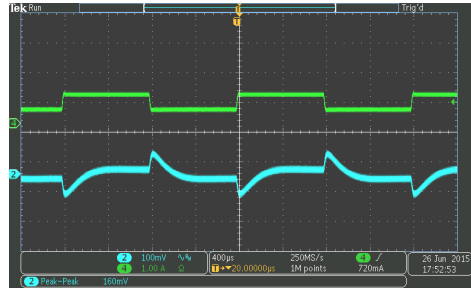

Vin=24V, load step 1A-1.5A-1A

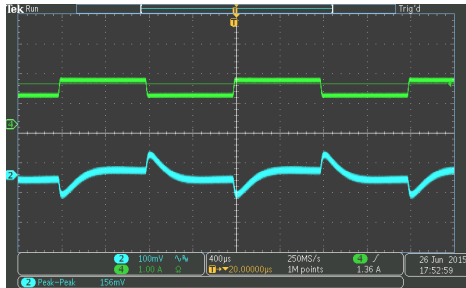

Vin=24V, load step 1.5A-2.4A-1.5A

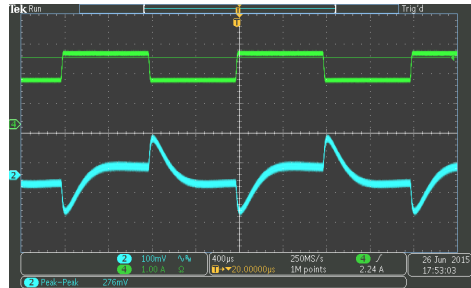

Vout=9V

Vin=24V, load step 0A-0.5A-0A

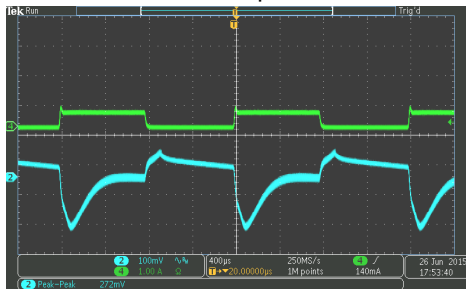

Vin=24V, load step 0.5A-1A-0.5A

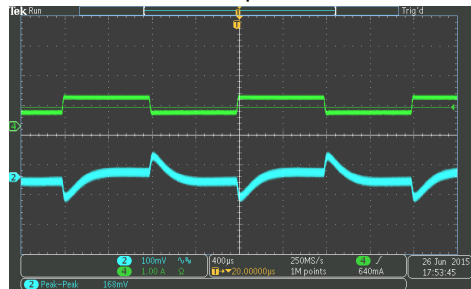

Vin=24V, load step 1A-1.5A-1A

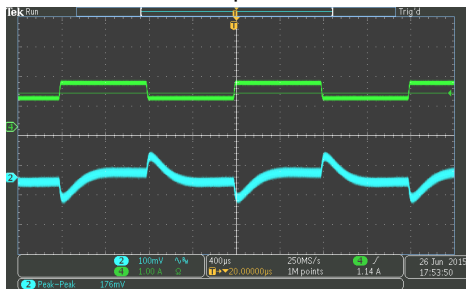

Vin=24V, load step 1.5A-2.4A-1.5A

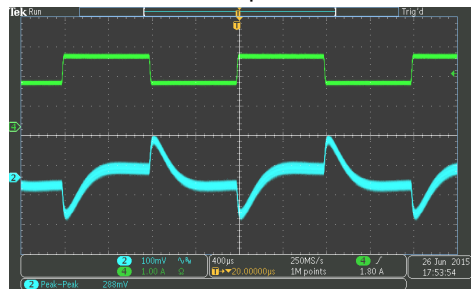

Vout=12V

Vin=24V, load step 0A-0.5A -0A

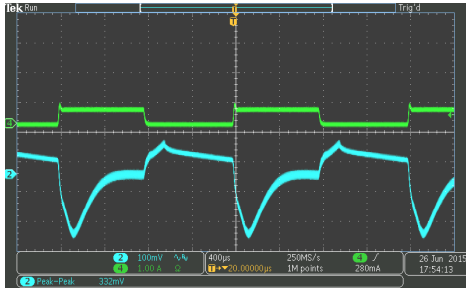

Vin=24V, load step 0.5A-1A-0.5A

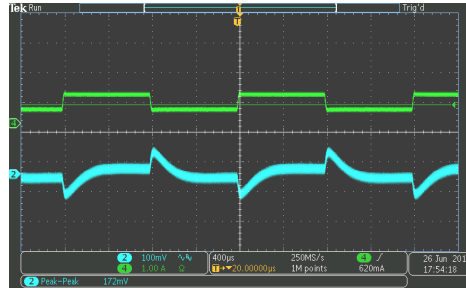

Vin=24V, load step 1A-1.5A-1A

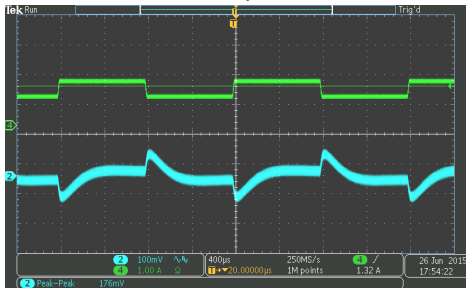

Vin=24V, load step 1.5A-2.4A-1.5A

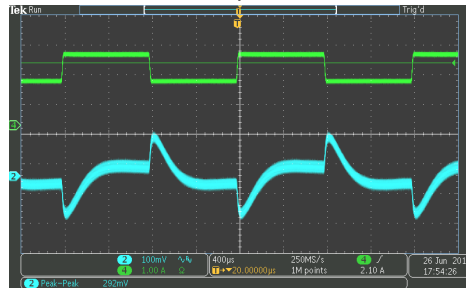

5.8. Output Voltage Transient

CH2:Vout,CH3:Vsw,CH4:IL

Vin=12V,lout=0A,Vout 5V—>9V

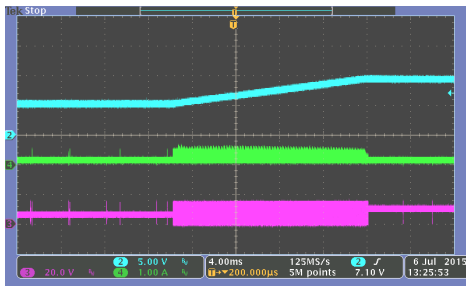

Vin=12V,lout=0A,Vout 9V—>5V

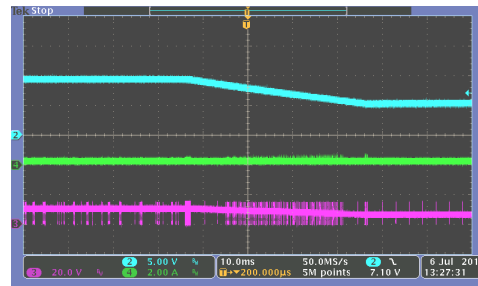

Vin=12V,lout=0A,Vout 9V—>12V

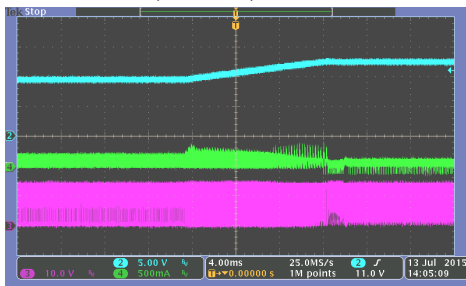

Vin=12V,lout=0A,Vout 12V—>5V

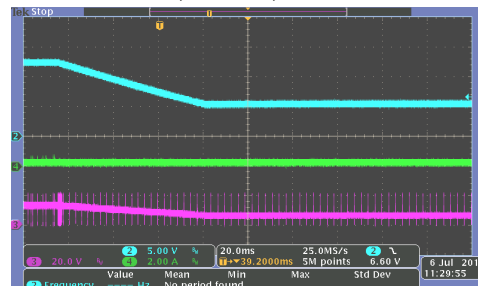

Vin=12V,Iout=2.4A,Vout 5V→9V

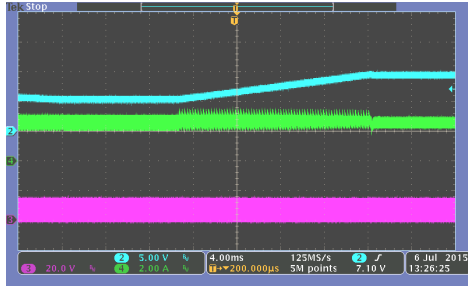

Vin=12V,Iout=2.4A,Vout 9V→5V

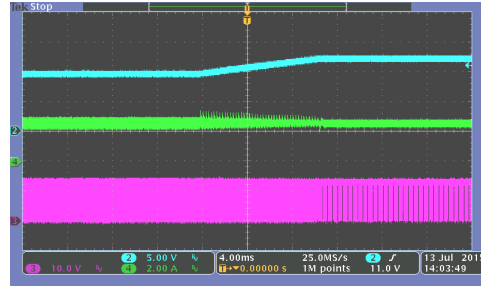

Vin=12V,Iout=0A,Vout 9V→12V

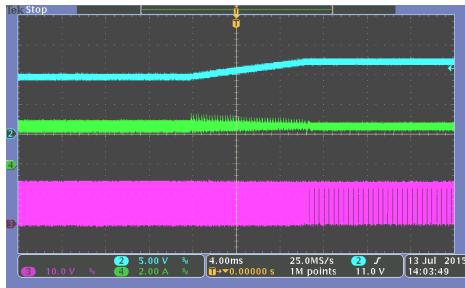

Vin=12V,Iout=0A,Vout 12V→5V

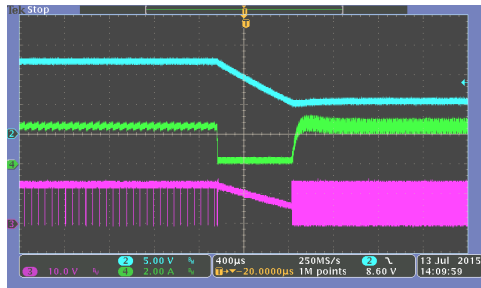

5.9. Line Dynamic Response(Vin change from 12V to 40V, 0.1V/us)

CH1:Vin, CH2:Vout ripple , output 5V/2.4A

Vin=12V-40V

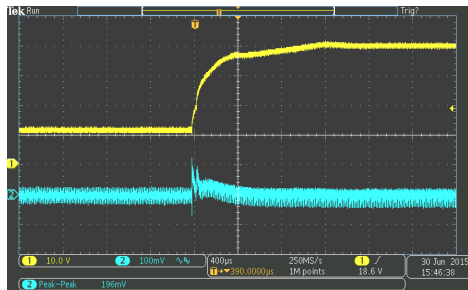

Vin=40V-12V

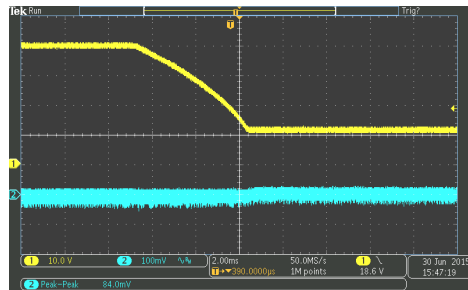

5.10.Key Components Temperature Test (burning for 2 hours)

Vout=5V

Vin/Iout	Ambient (°C)	PCB (°C)	IC (°C)	Schottky (°C)	Inductor (°C)
12V/2.4A	33	92	95	97	95
16V/2.4A	33	97	99	104	101
24V/2.4A	33	101	104	109	106

Vout=9V

Vin/Iout	Ambient (°C)	PCB (°C)	IC (°C)	Schottky (°C)	Inductor (°C)
12V/2A	33	74	75	73	72
16V/2A	33	84	85	88	83
24V/2A	33	92	93	96	91

Vout=12V

Vin/Iout	Ambient (°C)	PCB (°C)	IC (°C)	Schottky (°C)	Inductor (°C)
12V/2A	37	72	75	66	72
16V/2A	38	81	85	78	83
24V/2A	39	92	96	90	95



6. EMI TEST

6.1. Output 5V

Vin=12V Output 5V2.4A Horizontal

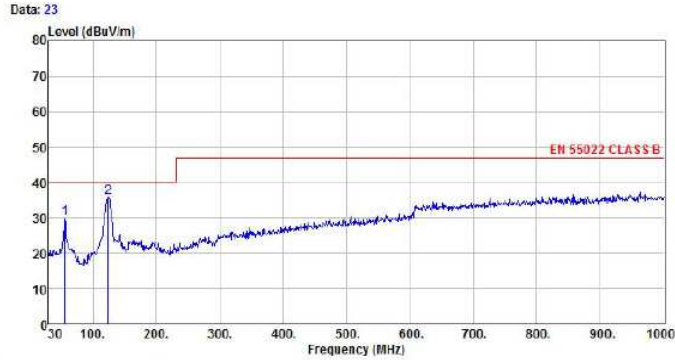

Site : chamber
 Condition : EN 55022 CLASS B 3m VULB9160 HORIZONTAL
 EUT :
 Model Name : 5
 Temp/Humi : 25°C / 53 %
 Power Rating: AC 230V/50Hz
 Mode :
 Memo :

	Freq	ReadAntenna	Cable Preamp	Limit	Over					
	MHz	Level	Loss	Line	Limit	Remark	Factor			
	MHz	dBuV	dB/m	dB	dB	dBuV/m	dBuV/m	dB		
1	55.22	16.32	12.40	1.00	0.00	29.72	40.00	-10.28 Peak	13.40	
2	pp	124.09	21.86	12.27	1.51	0.00	35.64	40.00	-4.36 Peak	13.78

Vin=12V Output 5V2.4A Vertical

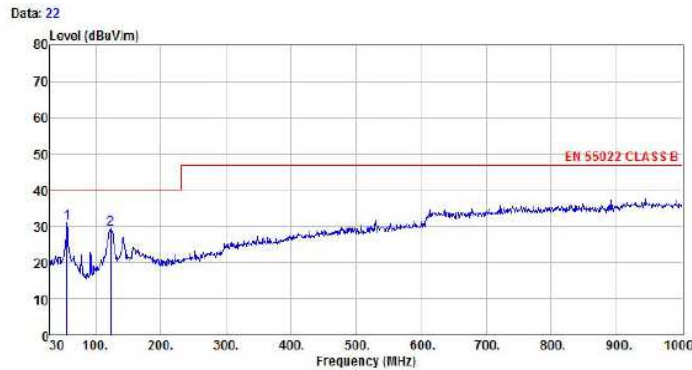

Site : chamber
 Condition : EN 55022 CLASS B 3m VULB9160 VERTICAL
 EUT :
 Model Name : 5
 Temp/Humi : 25°C / 53 %
 Power Rating: AC 230V/50Hz
 Mode :
 Memo :

	Freq	ReadAntenna	Cable Preamp	Limit	Over					
	MHz	Level	Loss	Line	Limit	Remark	Factor			
	MHz	dBuV	dB/m	dB	dB	dBuV/m	dBuV/m	dB		
1	pp	55.22	17.71	12.40	1.00	0.00	31.11	40.00	-8.89 Peak	13.40
2		123.12	15.33	12.27	1.50	0.00	29.10	40.00	-10.90 Peak	13.77

6.2. Output=9V

Vin=12V Output 9V2.4A Horizontal

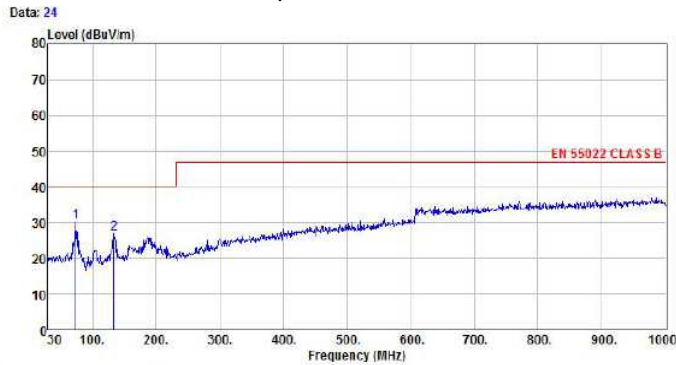

Site : chamber
 Condition : EN 55022 CLASS B 3m VULB9160 HORIZONTAL
 EUT :
 Model Name : 7
 Temp/Humi : 25°C / 53 %
 Power Rating: AC 230V/50Hz
 Mode :
 Memo :

	Freq	ReadAntenna	Cable	Preamp	Limit	Over				
	MHz	Level	Factor	Loss	Level	Line	Limit	Remark		
	MHz	dBuV	dB/m	dB	dB	dBuV/m	dBuV/m	dB		
1	pp	73.65	19.13	9.87	1.12	0.00	30.12	40.00	-9.88 Peak	10.99
2		133.79	12.29	12.92	1.61	0.00	26.82	40.00	-13.18 Peak	14.53

Vin=12V Output 9V2.4A Vertical

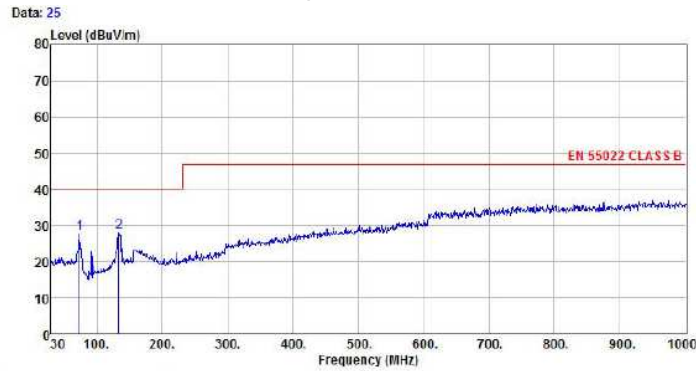

Site : chamber
 Condition : EN 55022 CLASS B 3m VULB9160 VERTICAL
 EUT :
 Model Name : 7
 Temp/Humi : 25°C / 53 %
 Power Rating: AC 230V/50Hz
 Mode :
 Memo :

	Freq	ReadAntenna	Cable	Preamp	Limit	Over				
	MHz	Level	Factor	Loss	Level	Line	Limit	Remark		
	MHz	dBuV	dB/m	dB	dB	dBuV/m	dBuV/m	dB		
1		73.65	16.69	9.87	1.12	0.00	27.68	40.00	-12.32 Peak	10.99
2	pp	133.79	13.50	12.92	1.61	0.00	28.03	40.00	-11.97 Peak	14.53