



Chipsmall Limited consists of a professional team with an average of over 10 year of expertise in the distribution of electronic components. Based in Hongkong, we have already established firm and mutual-benefit business relationships with customers from,Europe,America and south Asia,supplying obsolete and hard-to-find components to meet their specific needs.

With the principle of “Quality Parts,Customers Priority,Honest Operation,and Considerate Service”,our business mainly focus on the distribution of electronic components. Line cards we deal with include Microchip,ALPS,ROHM,Xilinx,Pulse,ON,Everlight and Freescale. Main products comprise IC,Modules,Potentiometer,IC Socket,Relay,Connector.Our parts cover such applications as commercial,industrial, and automotives areas.

We are looking forward to setting up business relationship with you and hope to provide you with the best service and solution. Let us make a better world for our industry!



## Contact us

Tel: +86-755-8981 8866 Fax: +86-755-8427 6832

Email & Skype: info@chipsmall.com Web: www.chipsmall.com

Address: A1208, Overseas Decoration Building, #122 Zhenhua RD., Futian, Shenzhen, China



## EAHP2024WA8

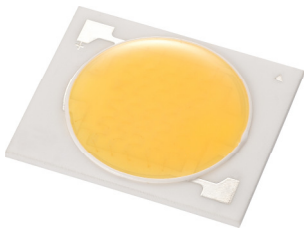

### Introduction

Everlight's EAHP2024WA8 Series is a ceramic substrate based LED achieving high efficiency while maintaining high CRI at Energy Star / ANSI color temperature ranges.

### Features

- ◆ LM-80 Certified
- ◆ High Power COB & High CRI LED
- ◆ Multi-Chip Solution
- ◆ Dimension: 20 mm x 24 mm x 1.6 mm
- ◆ Main Parameters: Luminous Flux, Forward Voltage, Chromaticity and Color Rendering Index
- ◆ ESD Protection
- ◆ RoHS compliant
- ◆ Energy Star / ANSI Compliant Binning Structure
- ◆ Typical Viewing Angle: 120°

### Applications

- ◆ Replacement Bulb
- ◆ Indoor General Lighting
- ◆ Recessed Can Lighting

## Absolute Maximum Ratings

Parameter	Symbol	Ratings	Unit
Max. DC Forward Current (mA)	$I_F$	550 <sub>[1]</sub>	mA
Max. Peak Pulse Current (mA)	$I_{Pulse}$	800 <sub>[2]</sub>	mA
Power Dissipation	$P_d$	16.5	W
Thermal Resistance	$R_{th}$	2.4	°C/W
Max. Junction Temperature	$T_J$	115	°C
Operating Temperature	$T_{Opr}$	-40 ~ +85	°C
Storage Temperature	$T_{Stg}$	-40 ~ +85	°C

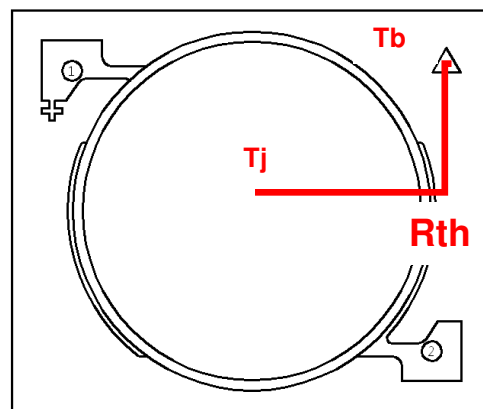

Measuring point for  
case temperature

### Notes:

1. For optimal performance, Everlight recommends 500mA operation.
2.  $t_p \leq 100ms$ , Duty cycle = 25%
3. The EAHP2024WA8 LEDs are not designed for reverse bias use.

## PN of the EAHP2024WA8 : White LEDs

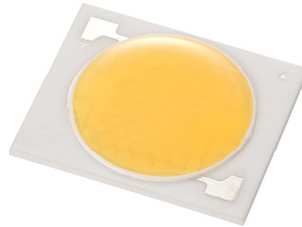

Color	Order Code of EAHP2024WA8	Minimum Luminous Flux (lm)	Typical Luminous Flux (lm)	CCT (K)	Forward Voltage (V)	Forward Current (mA)	CRI (min.)
Warm White 3500	EAHP2024WA8	1500	1700	35K-1~35K-4	27.0~33.0	500	80

**Notes:**

1. CRI measurement tolerance:  $\pm 2$ .
2. Luminous flux measurement tolerance:  $\pm 10\%$ .
3. The data of luminous flux measured at thermal pad=25°C
4. Typical luminous flux or light output performance is operated within the condition guided by this datasheet.

## Product Binning

### Luminous Flux Bins

Group	Bin	Minimum Photometric Flux (lm)	Maximum Photometric Flux (lm)
K	1	225	250
	2	250	275
	3	275	300
	4	300	325
	5	325	350
	6	350	375
	7	375	400
	8	400	425
	9	425	450
N	1	450	475
	2	475	500
	3	500	550
	4	550	600
	5	600	650
	6	650	700
	7	700	750
	8	750	800
	9	800	900

Group	Bin	Minimum Photometric Flux (lm)	Maximum Photometric Flux (lm)
P	1	900	1000
	2	1000	1100
	3	1100	1200
	4	1200	1350
	5	1350	1500
	6	1500	1650
	7	1650	1800
	8	1800	2000
	9	2000	2200
S	1	2200	2400
	2	2400	2650
	3	2650	2900
	4	2900	3200
	5	3200	3500
	6	3500	3850
	7	3850	4200
	8	4200	4600

## White Bin Structure

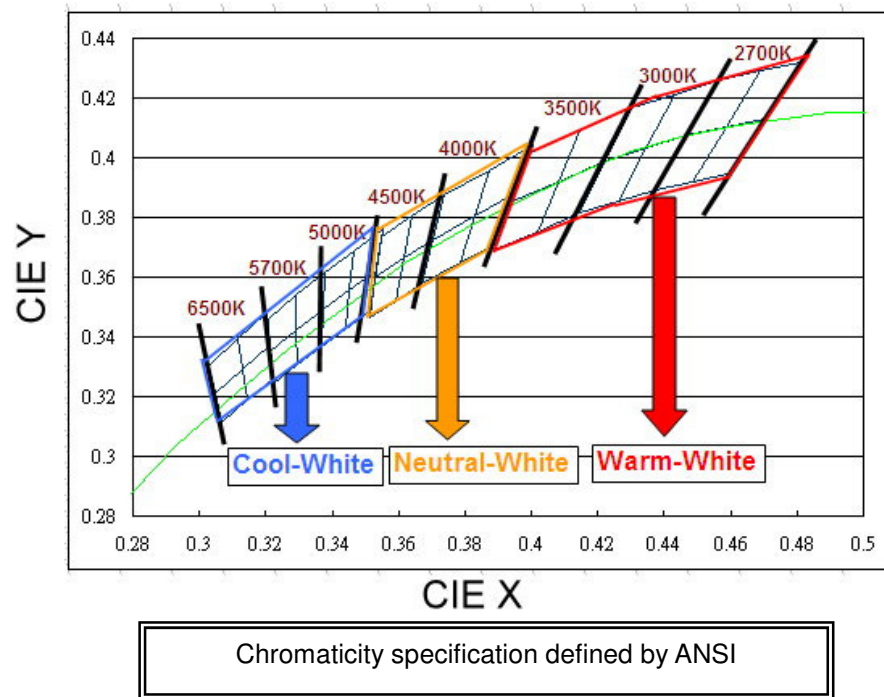

### Notes:

1. The CCT range of Cool-White varies from 4745K to 7050K.
2. The CCT range of Neutral-White varies from 3710K to 4745K.
3. The CCT range of Warm-White varies from 2580K to 3710K
4. Color coordinates measurement allowance :  $\pm 0.01$
5. Color bins are defined at  $I_f=500\text{mA}$  operation

### Warm White Bin Structure

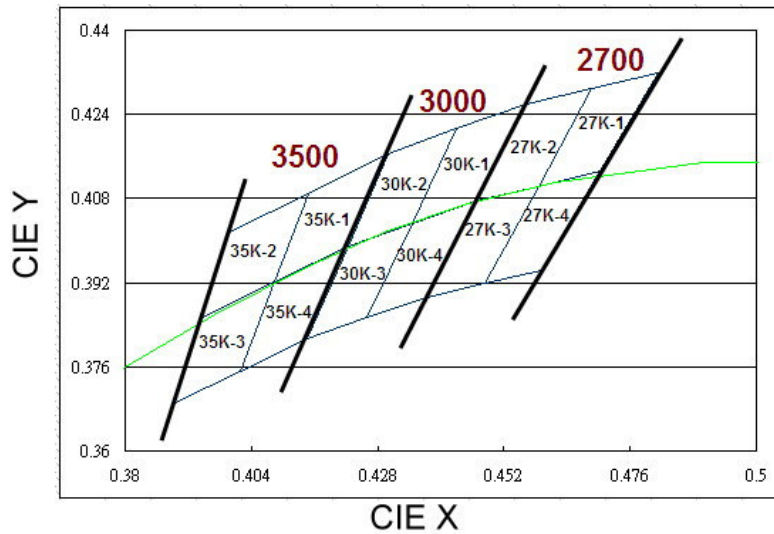

### Warm White Bin Coordinates

#### 2700K

Bin	CIE X	CIE Y
27K-1	0.469	0.429
	0.459	0.410
	0.470	0.413
	0.481	0.432
Reference Range: 2580~2700K		

Bin	CIE X	CIE Y
27K-2	0.456	0.426
	0.447	0.408
	0.459	0.410
	0.469	0.429
Reference Range: 2700~2870K		

Bin	CIE X	CIE Y
27K-4	0.459	0.410
	0.448	0.392
	0.459	0.394
	0.470	0.413
Reference Range: 2580~2700K		

Bin	CIE X	CIE Y
27K-3	0.447	0.408
	0.437	0.389
	0.448	0.392
	0.459	0.410
Reference Range: 2700~2870K		

#### 3000K

Bin	CIE X	CIE Y
30K-1	0.456	0.426
	0.443	0.421
	0.435	0.403
	0.447	0.408
Reference Range: 2870~3000K		

Bin	CIE X	CIE Y
30K-2	0.443	0.421
	0.430	0.417
	0.422	0.399
	0.435	0.403
Reference Range: 3000~3170K		

Bin	CIE X	CIE Y
30K-4	0.447	0.408
	0.435	0.403
	0.426	0.385
	0.437	0.389
Reference Range: 2870~3000K		

Bin	CIE X	CIE Y
30K-3	0.435	0.403
	0.422	0.399
	0.415	0.381
	0.426	0.385
Reference Range: 3000~3170K		

**3500K**

Bin	CIE X	CIE Y
35K-1	0.415	0.409
	0.408	0.392
	0.422	0.399
	0.430	0.417
Reference Range: 3220~3500K		

Bin	CIE X	CIE Y
35K-2	0.400	0.402
	0.394	0.385
	0.408	0.392
	0.415	0.409
Reference Range: 3500~3710K		

Bin	CIE X	CIE Y
35K-4	0.408	0.392
	0.402	0.375
	0.415	0.381
	0.422	0.399
Reference Range: 3220~3500K		

Bin	CIE X	CIE Y
35K-3	0.394	0.385
	0.389	0.369
	0.402	0.375
	0.408	0.392
Reference Range: 3500~3710K		

**Neutral-White Bin Structure**

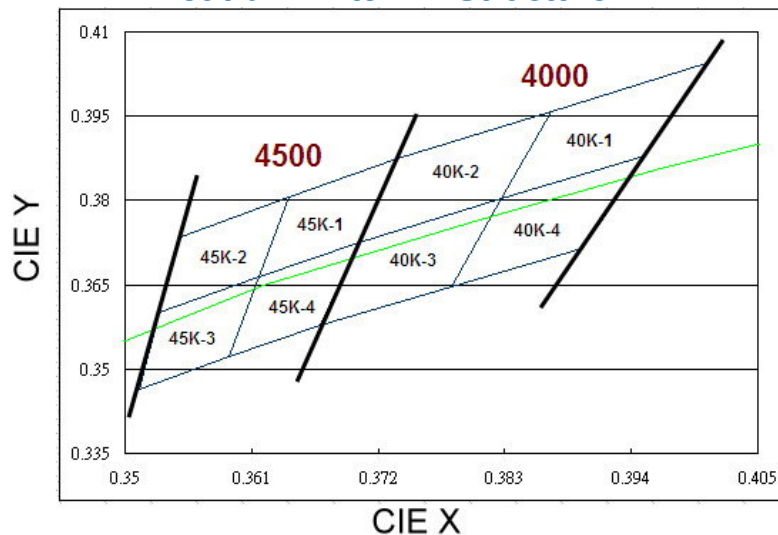

**Neutral-White Bin Coordinates**

**4000K**

Bin	CIE X	CIE Y
40K-1	0.387	0.396
	0.383	0.380
	0.395	0.388
	0.401	0.404
Reference Range: 3710~4000K		

Bin	CIE X	CIE Y
40K-2	0.374	0.387
	0.370	0.373
	0.383	0.380
	0.387	0.396
Reference Range: 4000~4260K		

Bin	CIE X	CIE Y
40K-4	0.383	0.380
	0.378	0.365
	0.390	0.372
	0.395	0.388
Reference Range: 3710~4000K		

Bin	CIE X	CIE Y
40K-3	0.370	0.373
	0.367	0.358
	0.378	0.365
	0.383	0.380
Reference Range: 4000~4260K		



**4500K**

Bin	CIE X	CIE Y
45K-1	0.364	0.381
	0.362	0.366
	0.370	0.373
	0.374	0.387
Reference Range: 4260~4500K		

Bin	CIE X	CIE Y
45K-2	0.355	0.374
	0.353	0.360
	0.362	0.366
	0.364	0.381
Reference Range: 4500~4745K		

Bin	CIE X	CIE Y
45K-4	0.362	0.366
	0.359	0.352
	0.367	0.358
	0.370	0.373
Reference Range: 4260~4500K		

Bin	CIE X	CIE Y
45K-3	0.353	0.360
	0.351	0.347
	0.359	0.352
	0.362	0.366
Reference Range: 4500~4745K		

**Cool-White Bin Structure**

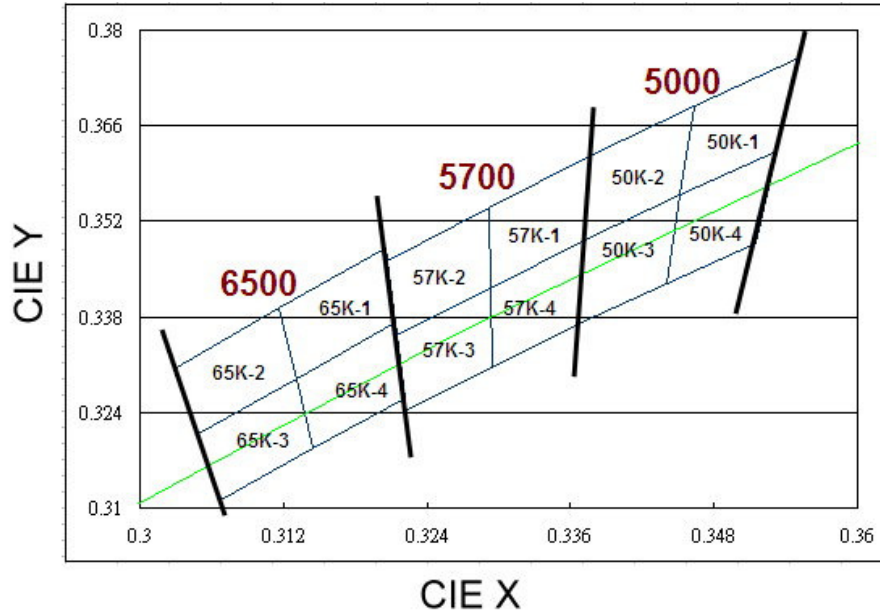

**Cool-White Bin Coordinates**

**5000K**

Bin	CIE X	CIE Y
50K-1	0.346	0.369
	0.345	0.356
	0.353	0.362
	0.355	0.376
Reference Range: 4745~5000K		

Bin	CIE X	CIE Y
50K-2	0.338	0.362
	0.337	0.349
	0.345	0.356
	0.346	0.369
Reference Range: 5000~5310K		

Bin	CIE X	CIE Y
50K-4	0.345	0.356
	0.344	0.343
	0.352	0.349
	0.353	0.362
Reference Range: 4745~5000K		

Bin	CIE X	CIE Y
50K-3	0.337	0.349
	0.337	0.337
	0.344	0.343
	0.345	0.356
Reference Range: 5000~5310K		

**5700K**

Bin	CIE X	CIE Y
57K-1	0.329	0.354
	0.329	0.342
	0.337	0.349
	0.338	0.362
Reference Range: 5310~5700K		

Bin	CIE X	CIE Y
57K-2	0.321	0.346
	0.322	0.335
	0.329	0.342
	0.329	0.354
Reference Range: 5700~6020K		

Bin	CIE X	CIE Y
57K-4	0.329	0.342
	0.329	0.331
	0.337	0.337
	0.337	0.349
Reference Range: 5310~5700K		

Bin	CIE X	CIE Y
57K-3	0.322	0.335
	0.322	0.324
	0.329	0.331
	0.329	0.342
Reference Range: 5700~6020K		

**6500K**

Bin	CIE X	CIE Y
65K-1	0.312	0.339
	0.313	0.329
	0.321	0.337
	0.321	0.348
Reference Range: 6020~6500K		

Bin	CIE X	CIE Y
65K-2	0.303	0.330
	0.305	0.321
	0.313	0.329
	0.312	0.339
Reference Range: 6500~7050K		

Bin	CIE X	CIE Y
65K-4	0.313	0.329
	0.315	0.319
	0.322	0.326
	0.321	0.337
Reference Range: 6020~6500K		

Bin	CIE X	CIE Y
65K-3	0.305	0.321
	0.307	0.311
	0.315	0.319
	0.313	0.329
Reference Range: 6500~7050K		

**Notes:**

1. Color coordinates measurement allowance :  $\pm 0.01$ .

### Forward Voltage Bins

Bin	Minimum Forward Voltage (V)	Maximum Forward Voltage (V)
W1	27	29
W2	29	31
W3	31	33

**Notes:**

1. Forward voltage measurement tolerance:  $\pm 2\%$ .
2. Forward voltage bins are defined at  $I_f=500\text{mA}$  operation.
3. Other Forward Voltage bins for White LEDs available upon request. Please contact your local Everlight sales office.

## Mechanical Dimension

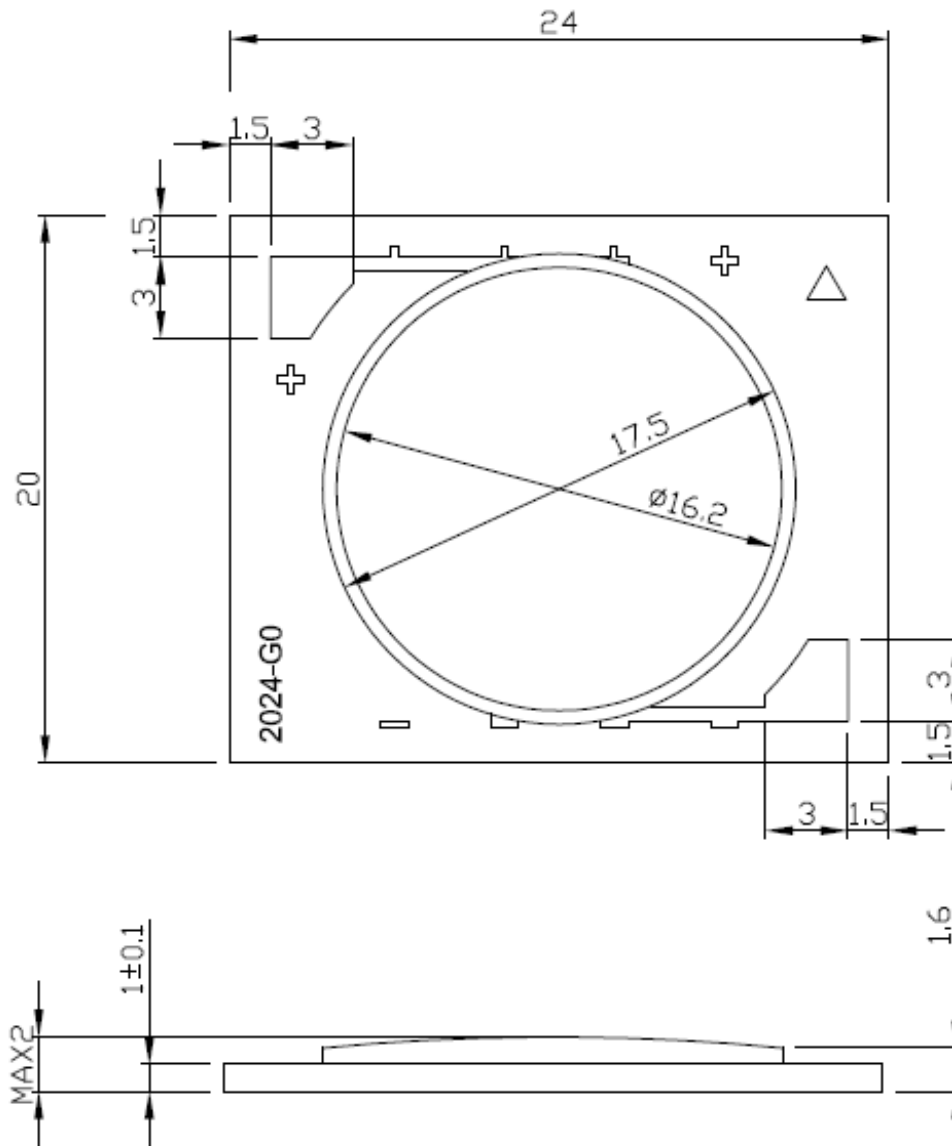

## Chip Configuration

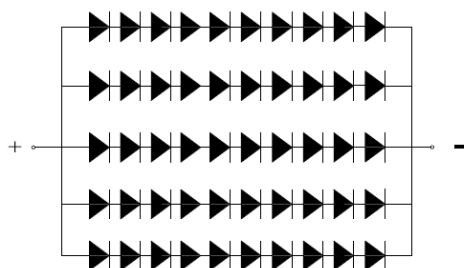

10series  $\times$  5parallel = 50 pcs of LEDs

**Note:**

1. Dimensions are in millimeters.
2. Tolerances unless mentioned are  $\pm 0.25$ mm.

## Pad Configuration

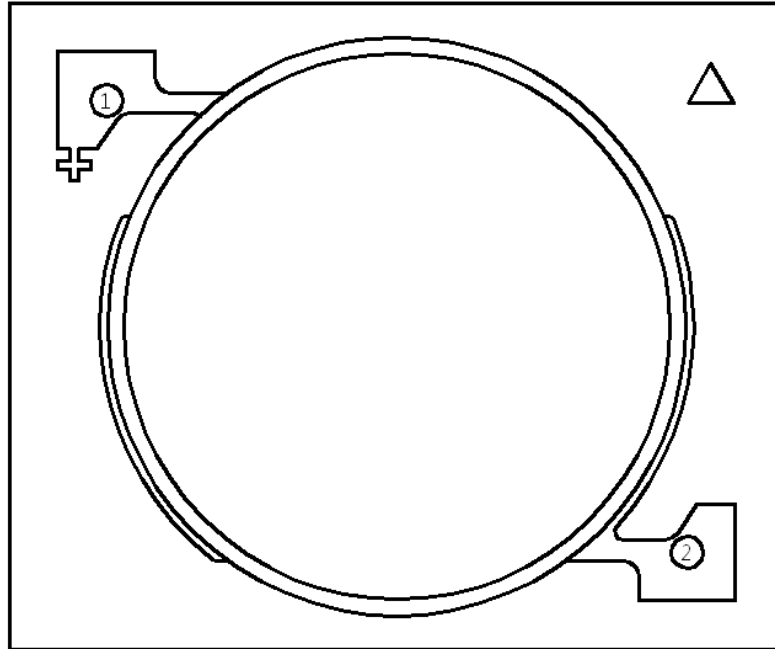

PAD	FUNCTION
1	ANODE
2	CATHODE

## 15W COB Series Typical Electro-Optical Characteristic Curve

Relative Spectral Distribution  
@ Substrate Temperature = 25°C

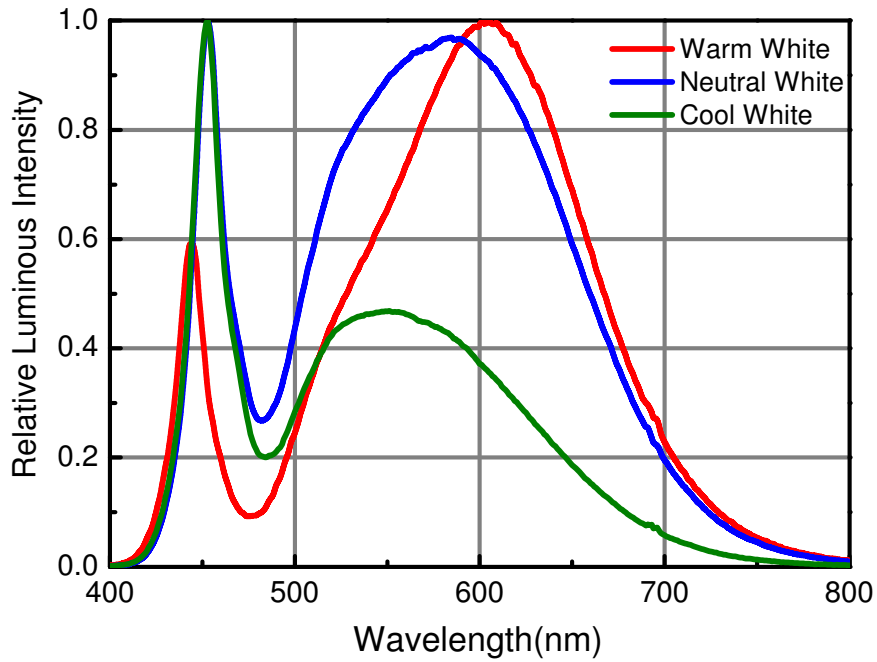

Relative Luminous Flux vs. Substrate Temperature  
@Forward Current = 500mA

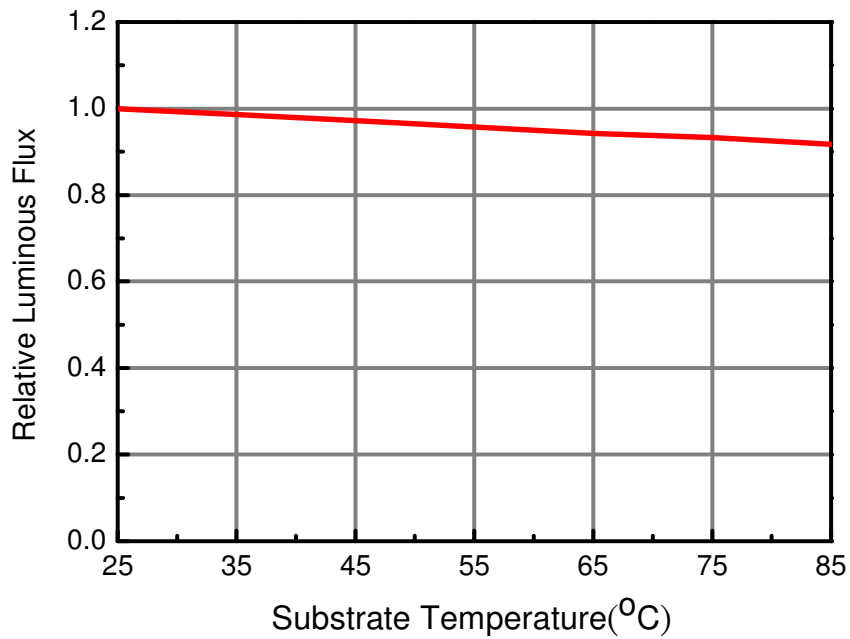

**Forward Voltage vs. Forward Current**  
**@ Substrate Temperature = 25°C**

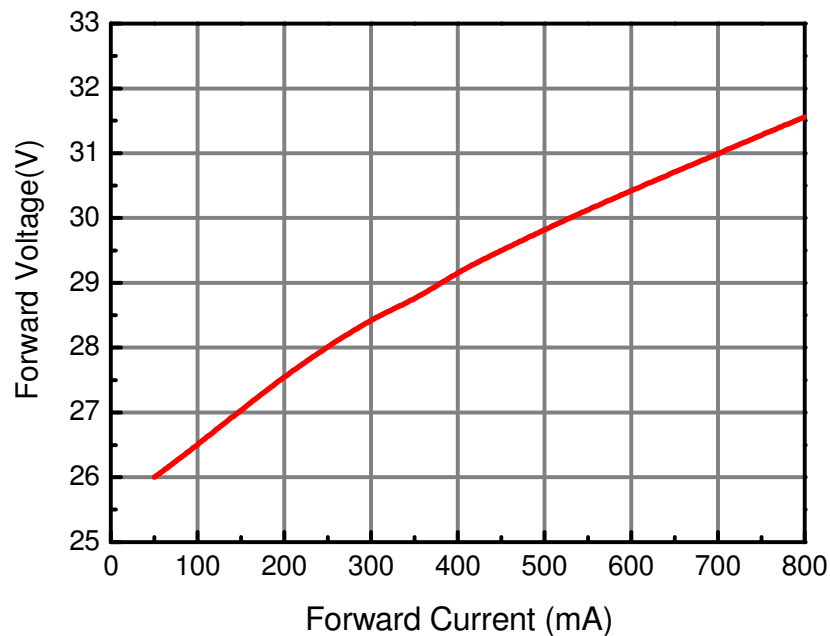

**Relative Luminous Flux vs. Forward Current**  
**@ Substrate Temperature = 25°C**



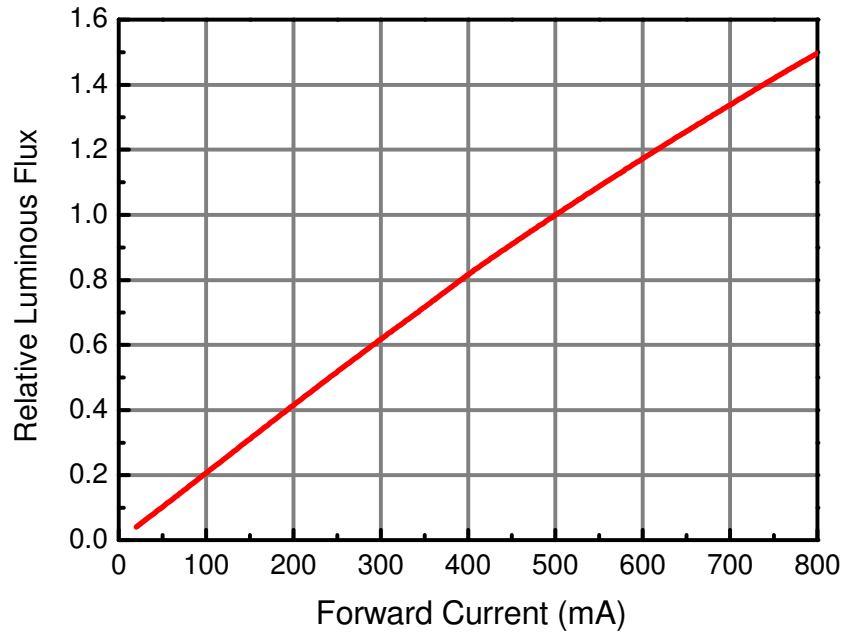

**Correlated Color Temperature vs. Forward Current  
@ Substrate Temperature = 25°C**

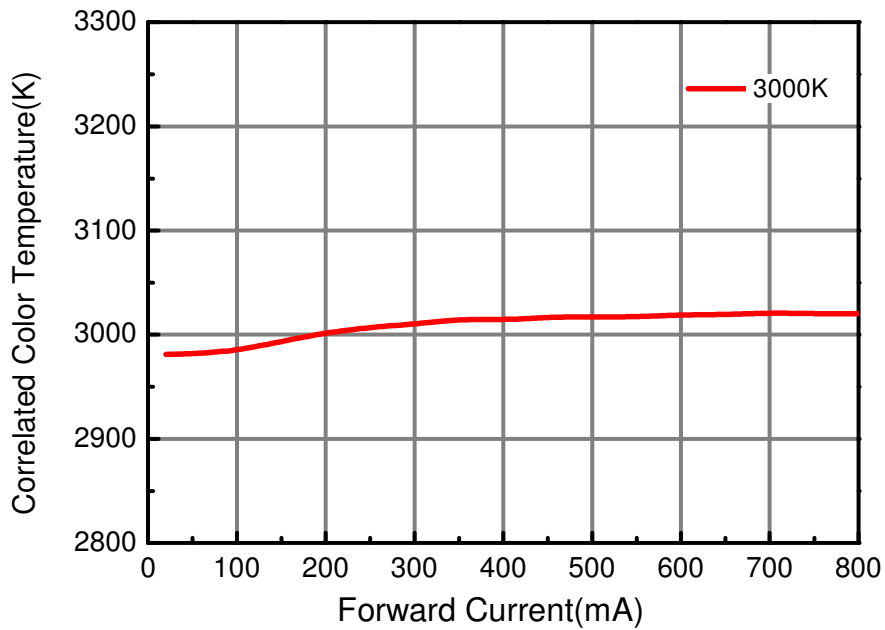

**Correlated Color Temperature vs. Substrate Temperature**

@ Forward Current = 500mA

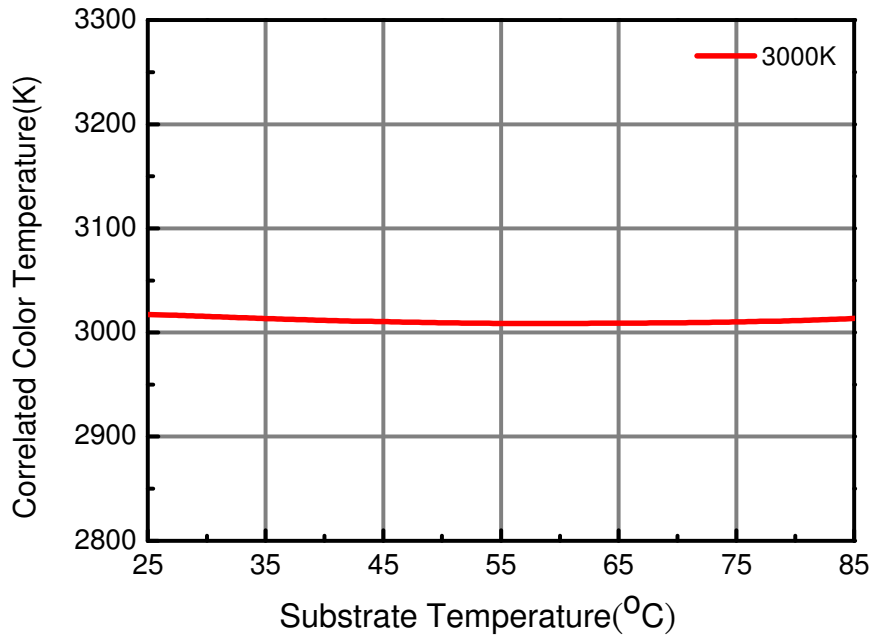

**Forward Voltage vs. Substrate Temperature**  
@ Forward Current = 500mA

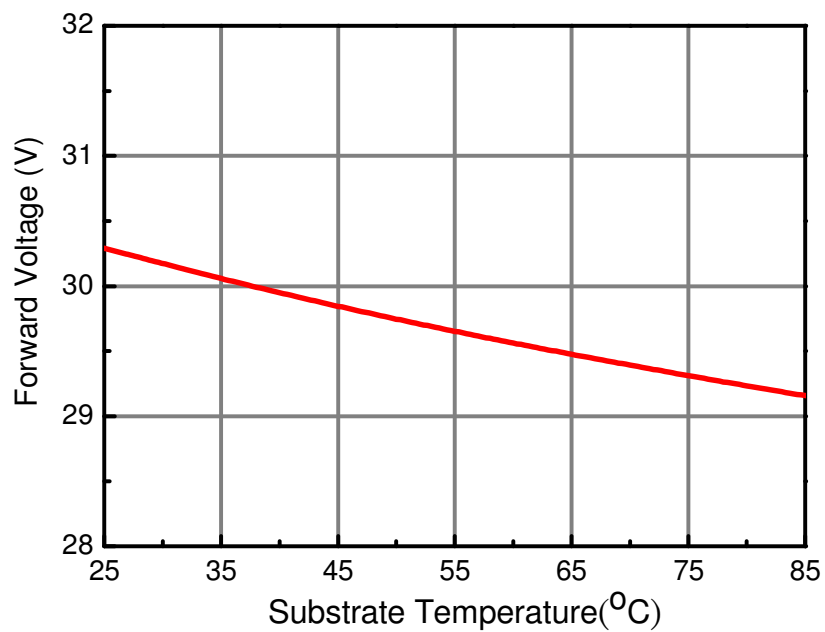

**Forward Current Derating Curve  
@ Junction Temperature <115°C**

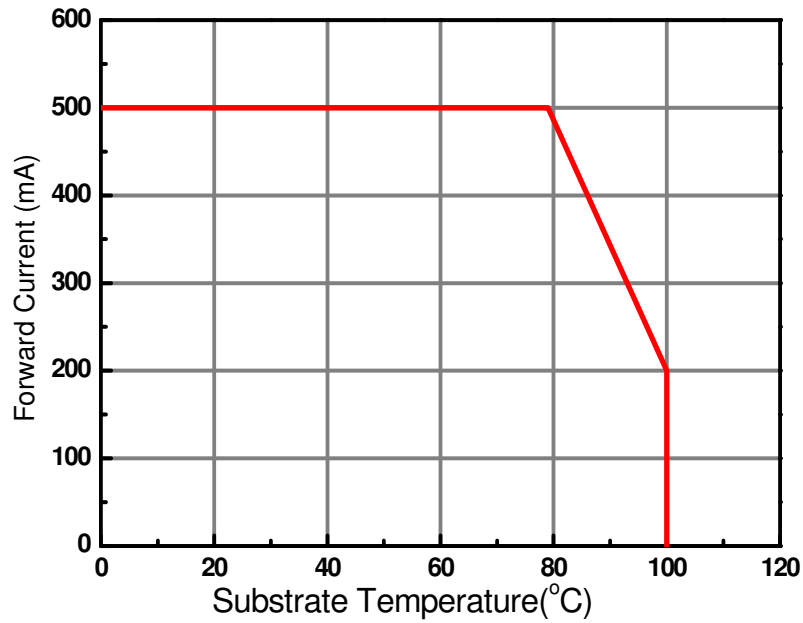

**Typical Diagram Characteristics of Radiation Patterns**

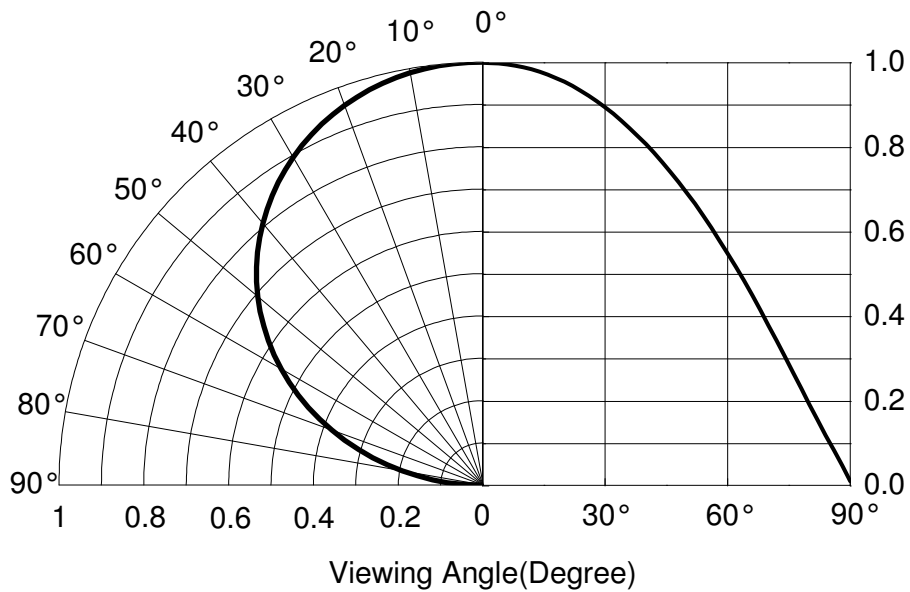

**Notes:**

1. 2θ<sub>1/2</sub> is the off axis angle from lamp centerline where the luminous intensity is 1/2 of the peak value.
2. Viewing angle tolerance is ± 5° .

## Product Labeling

### Label Explanation

CPN: Customer Specification (when required)

P/N : Everlight Production Number

QTY: Packing Quantity

CAT: Luminous Flux (Brightness) Bin

HUE: Color Bin

REF: Forward Voltage Bin

LOT No: Lot Number

MADE IN TAIWAN: Production Place

### Carrier Tray Specification

Loaded Quantity:48 PCS Per Tray

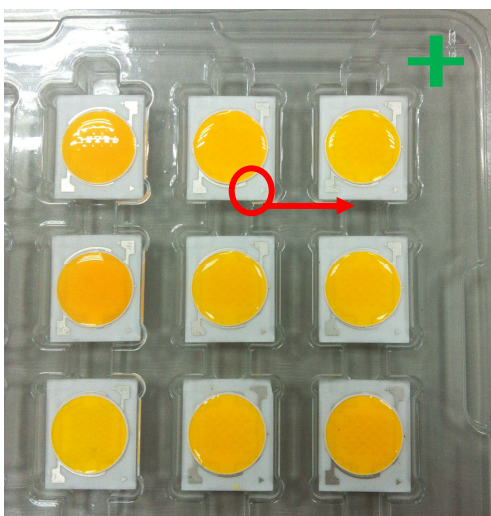

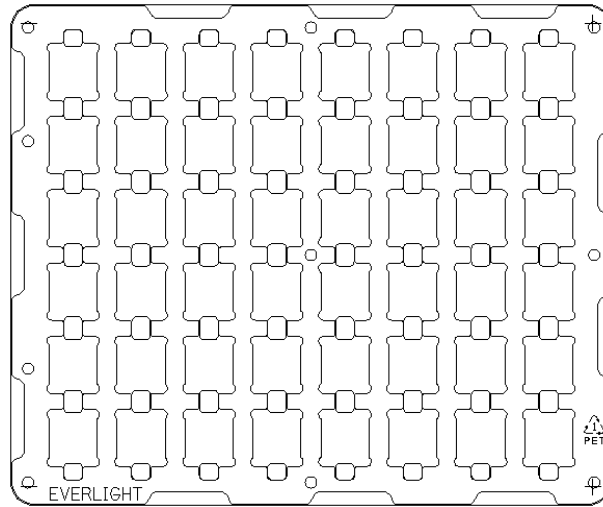

### LED Direction

- The **triangle mark** on the LEDs will be toward the **Anode mark** on the carrier tray.

### Moisture Resistant Packaging



Aluminum moisture-proof bag

Desiccant

### Outside Carton

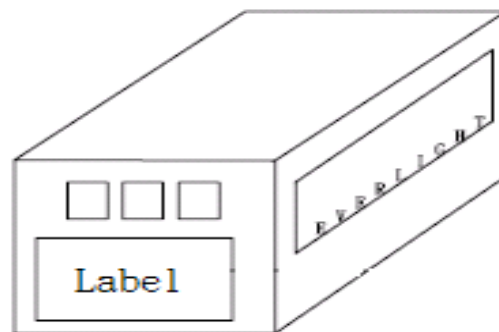

### Packaging Quantity

- 48 PCS Per Tray
- 10 Trays Per Outside Carton

## Precautions of Use

### Over-Current-Proof

- Though the EAHP2024WA8 has a conducted ESD protection mechanism, customers must not use the device in reverse and should apply resistors for extra protection. Otherwise slight voltage shift may cause significant current changes and burn out failure may happen.

### Storage

- Before the package is opened. The LEDs should be stored at 30°C or less and 50%RH or less after being shipped from Everlight and the storage life limits are 6 months. If the LEDs are stored for 6 months or more, they should be stored in a sealed container with a nitrogen atmosphere and moisture absorbent material.
- After opening the package: The LED's should be stored under 30°C or less and 60%RH or less. The LED should be used within 168hrs (7days) after opening the package. If unused LEDs remain, it should be stored in moisture proof packages.
- Do not stack assemblies..



### Handling

- Do not put mechanical stress on the LED.
- Never touch the optical surface with a finger or sharp object. The LED surface could be soiled or damaged, which could affect the optical performance of the LED.
- In a low-humidity work environment, please keep handling the LEDs with appropriate ESD grounding.
- It is recommended to handle the LED with powder-less latex gloves.

## Manual Handling

When handling the product, do not apply direct pressure on the optical surface.

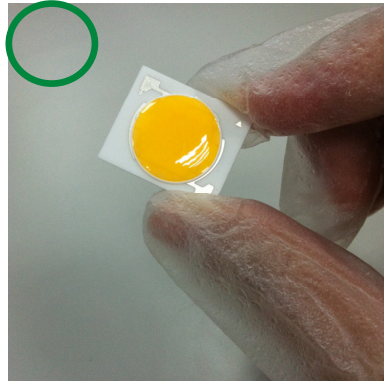

Do not touch the resin with tweezers to avoid scratching or other damage.

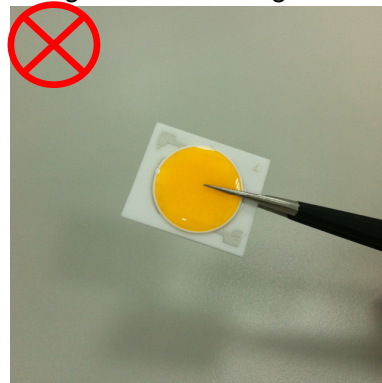
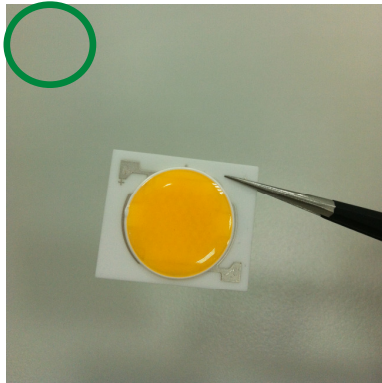

## Thermal Management

- Sufficient thermal management must be implemented. The substrate temperature must be kept under 85°C at the driving current 500mA. Otherwise, the junction temperature of die may exceed over the limit at high current driving conditions and the LEDs' lifetime may be decrease dramatically.

## Revision History

Current version: **15.Jul.2014**

Issue No: DHE-000XXXX

Version: 1

Page	Subjects (major change in previous version)	Date of change