



Chipsmall Limited consists of a professional team with an average of over 10 year of expertise in the distribution of electronic components. Based in Hongkong, we have already established firm and mutual-benefit business relationships with customers from,Europe,America and south Asia,supplying obsolete and hard-to-find components to meet their specific needs.

With the principle of "Quality Parts,Customers Priority,Honest Operation,and Considerate Service",our business mainly focus on the distribution of electronic components. Line cards we deal with include Microchip,ALPS,ROHM,Xilinx,Pulse,ON,Everlight and Freescale. Main products comprise IC,Modules,Potentiometer,IC Socket,Relay,Connector.Our parts cover such applications as commercial,industrial, and automotives areas.

We are looking forward to setting up business relationship with you and hope to provide you with the best service and solution. Let us make a better world for our industry!



Contact us

Tel: +86-755-8981 8866 Fax: +86-755-8427 6832

Email & Skype: info@chipsmall.com Web: www.chipsmall.com

Address: A1208, Overseas Decoration Building, #122 Zhenhua RD., Futian, Shenzhen, China



SMD ■ Full Color Top View LEDs EAPL3528RYA0

PRELIMINARY



Features

- P-LCC-4 package.
- White package.
- Optical indicator.
- Colorless clear window.
- Ideal for backlight and light pipe application.
- Inter reflector.
- Wide viewing angle.
- Suitable for vapor-phase reflow.
- Computable with automatic placement equipment.
- Available on tape and reel (8mm Tape).
- Pb-free.
- The product itself will remain within RoHS compliant version.
- Precondition: Bases on JEDEC J-STD 020D Level 3

Description

The 67-22 series is available in soft red, green, blue and yellow. Due to the package design, the LED has wide viewing angle and optimized light coupling by inter reflector. This feature makes the ideal for light pipe application. The low current requirement makes this device ideal for portable equipment or any other application where power is at a premium.

Applications

- Telecommunication: indicator and backlighting in telephone and fax.
- Flat backlight for LCD's, switches and symbols.
- Light pipe application.
- General use.

Device Selection Guide

Chip Materials	Emitted Color	Resin Color
AlGaInP	Brilliant Red	Water Clear
AlGaInP	Brilliant Yellow	Water Clear

Absolute Maximum Ratings (Ta=25°C)

Parameter	Symbol	Rating	Unit
Reverse Voltage	V_R	5	V
Forward Current	I_F	30	mA
Peak Forward Current (Duty 1/10 @1KHz)	I_{FP}	60	mA
Power Dissipation	P_d	60	mW
Junction Temperature	T_j	115	°C
Operating Temperature	T_{opr}	-40 ~ +85	°C
Storage Temperature	T_{stg}	-40 ~ +90	°C
Thermal Resistance	$R_{th\ J-A}$	500	K/W
	$R_{th\ J-S}$	300	K/W
ESD (Classification acc. AEC Q101)	ESD_{HBM}	2000	V
	ESD_{MM}	200	V
Soldering Temperature	T_{sol}	Reflow Soldering : 260 °C for 10 sec.	
		Hand Soldering : 350 °C for 3 sec.	

Electro-Optical Characteristics (Ta=25°C)

Parameter	Symbol	Min.	Typ.	Max.	Unit	Condition
Luminous Intensity	I _v	R6	72	-----	285	mcd I _F =20mA
		Y2	72	-----	285	
Viewing Angle	2θ _{1/2}	-----	120	-----	deg	I _F =20mA
Peak Wavelength	λ _p	R6	-----	632	-----	nm I _F =20mA
		Y2	-----	591	-----	
Dominant Wavelength	λ _d	R6	621	-----	631	nm I _F =20mA
		Y2	586	-----	594	
Spectrum Radiation Bandwidth	Δλ	R6	-----	20	-----	nm I _F =20mA
		Y2	-----	15	-----	
Forward Voltage	V _F	R6	1.75	-----	2.35	V I _F =20mA
		Y2	1.75	-----	2.35	
Reverse Current	I _R	R6	-----	-----	50	μA V _R =5V
		Y2	-----	-----	50	

Note:

1. Tolerance of Luminous Intensity: ±11%
2. Tolerance of Dominant Wavelength: ±1nm
3. Tolerance of Forward Voltage: ±0.1V

Bin Range of Luminous Intensity

Chip	Bin Code	Min.	Max.	Unit	Condition
R6/Y2	Q1	72	90	mcd	$I_F = 20\text{mA}$
	Q2	90	112		
	R1	112	140		
	R2	140	180		
	S1	180	225		
	S2	225	285		

Note:
Tolerance of Luminous Intensity: $\pm 11\%$

Bin Range of Dominant Wavelength

Chip	Bin Code	Min.	Max.	Unit	Condition
R6	FF1	621	626	nm	$I_F = 20\text{mA}$
	FF2	626	631		
Y2	DD1	586	588		
	DD2	588	590		
	DD3	590	592		
	DD4	592	594		

Note:
Tolerance of Dominant Wavelength: $\pm 1\text{nm}$

Bin Range of Forward Voltage

Chip	Bin Code	Min.	Max.	Unit	Condition
R6S	0	1.75	1.95	V	$I_F = 20\text{mA}$
	1	1.95	2.15		
	2	2.15	2.35		
G6S	0	1.75	1.95		
	1	1.95	2.15		
	2	2.15	2.35		

Note:
Tolerance of Forward Voltage: $\pm 0.1\text{V}$

Typical Electro-Optical Characteristics Curves

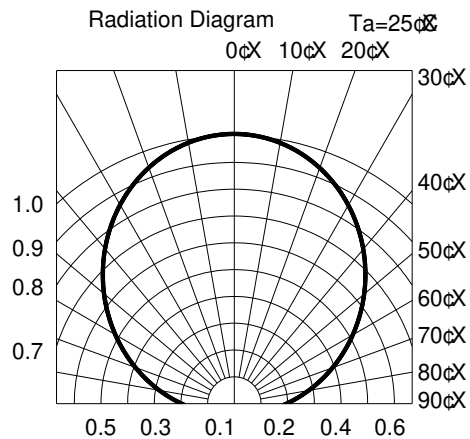
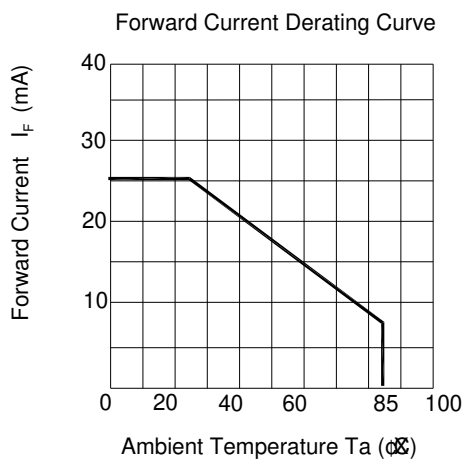
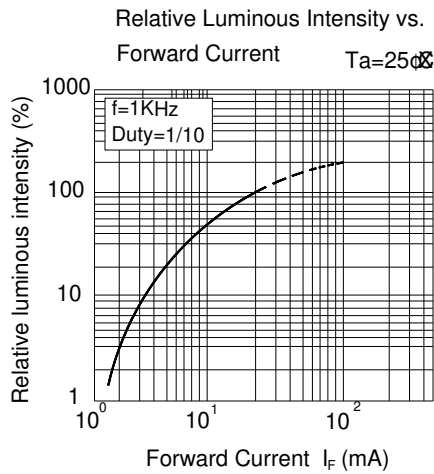
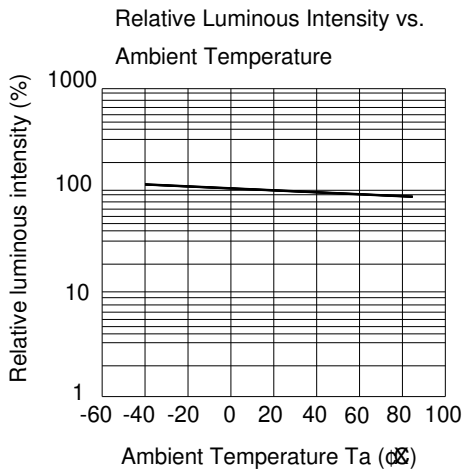
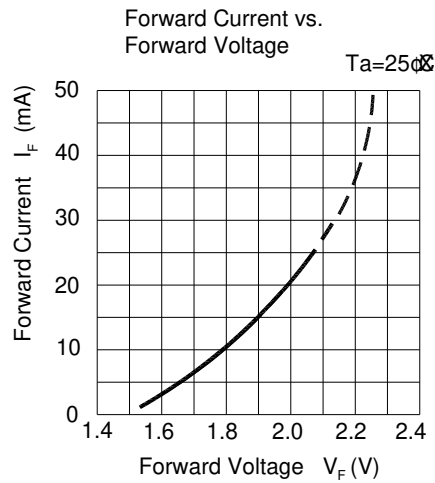
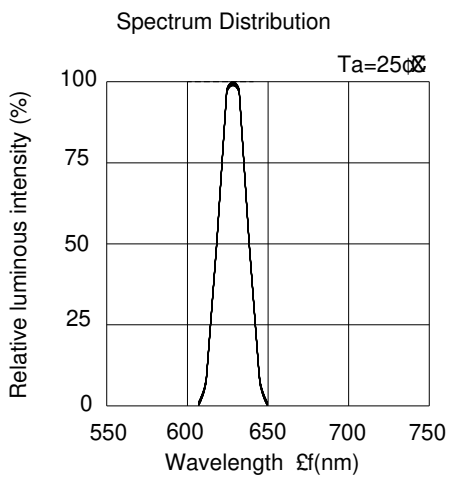

Typical Electro-Optical Characteristics Curves

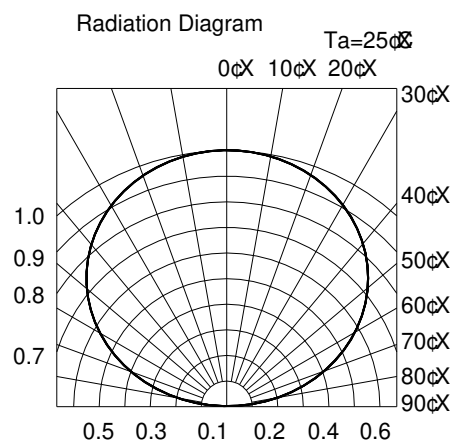
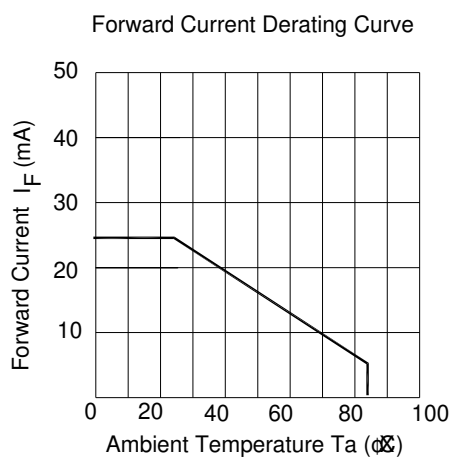
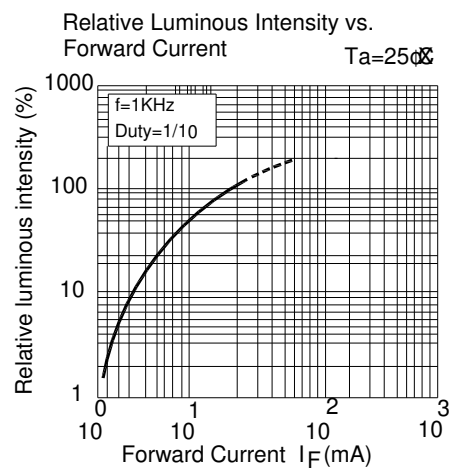
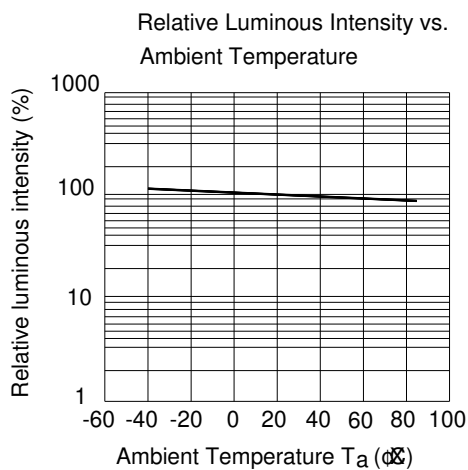
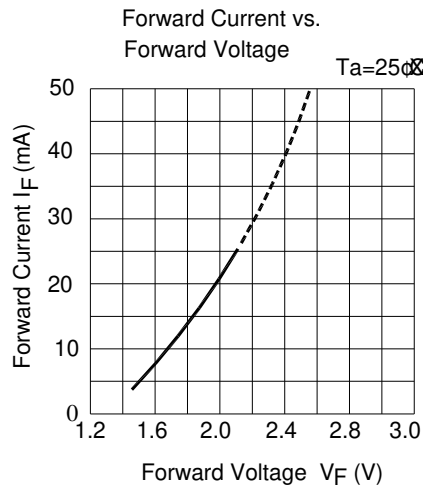
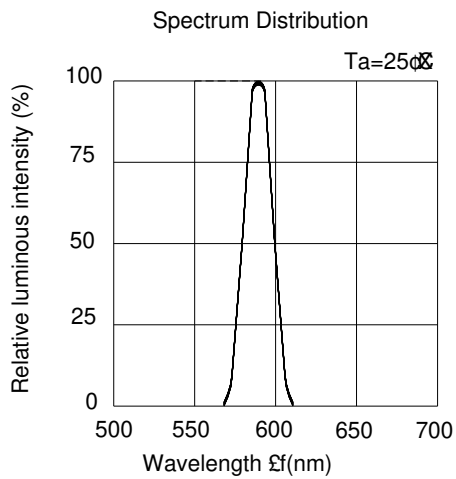

Package Dimension

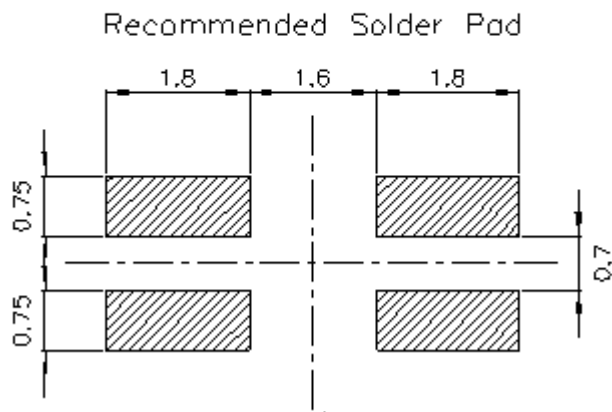
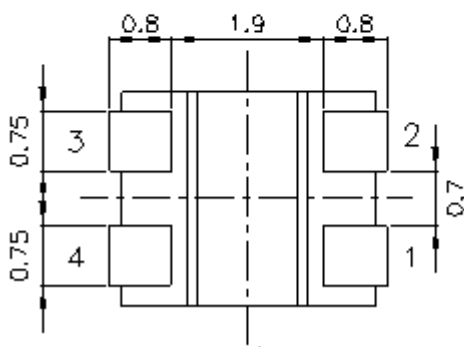
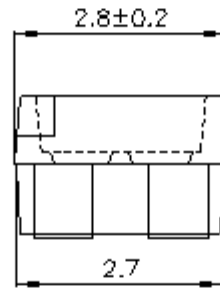
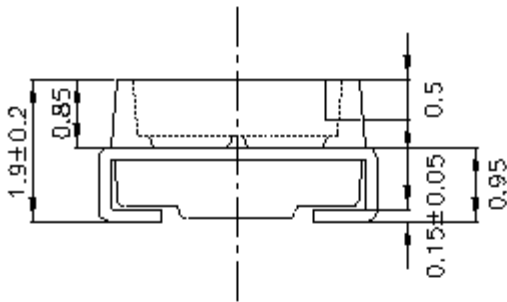
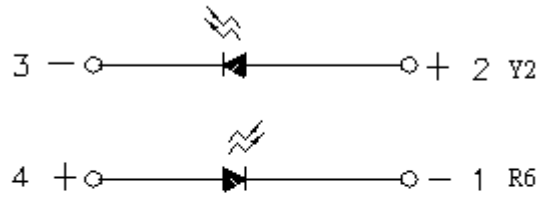
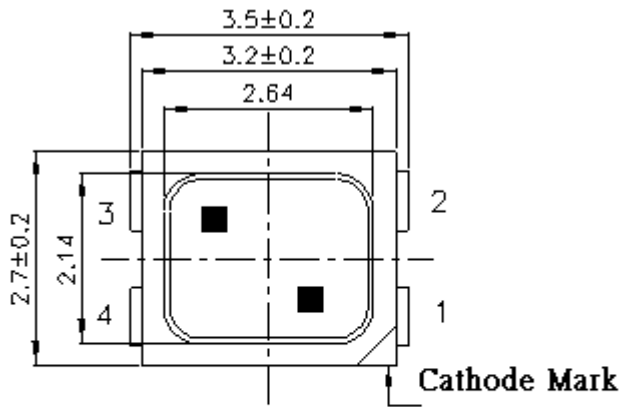

Note: Tolerances unless mentioned ± 0.1 mm. Unit = mm

Moisture Resistant Packing Materials

Label Explanation



- CPN: Customer's Product Number
- P/N: Product Number
- QTY: Packing Quantity
- CAT: Luminous Intensity Rank
- HUE: Dom. Wavelength Rank
- REF: Forward Voltage Rank
- LOT No: Lot Number

Reel Dimensions

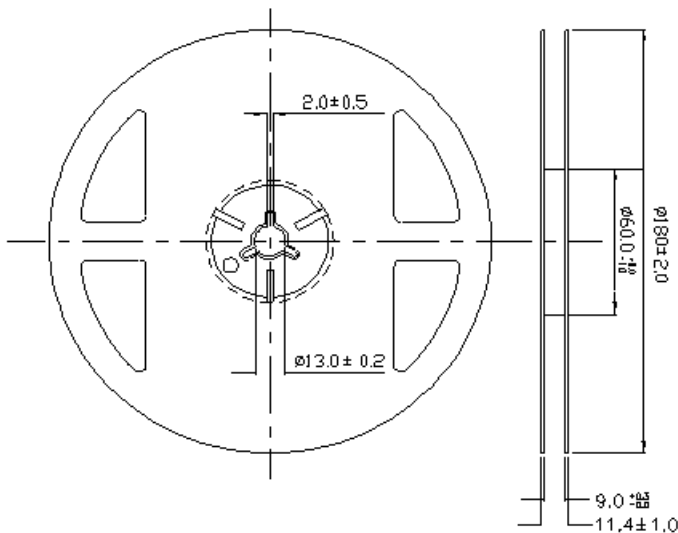

Carrier Tape Dimensions: Loaded Quantity 2000 pcs Per Reel

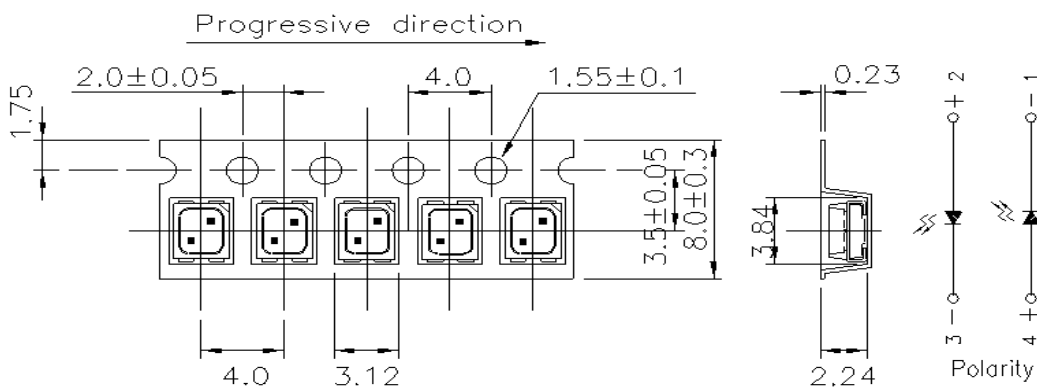

Note: Tolerances unless mentioned ± 0.1 mm. Unit = mm

Moisture Resistant Packing Process

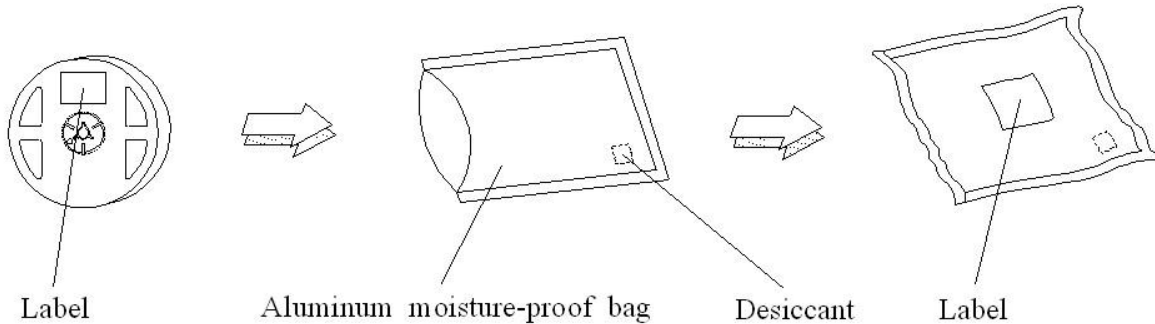

Note: Tolerances unless mentioned $\pm 0.1\text{mm}$. Unit = mm

Precautions for Use

1. Over-current-proof

1.1 Customer must apply resistors for protection, otherwise slight voltage shift will cause big current change (Burn out will happen).

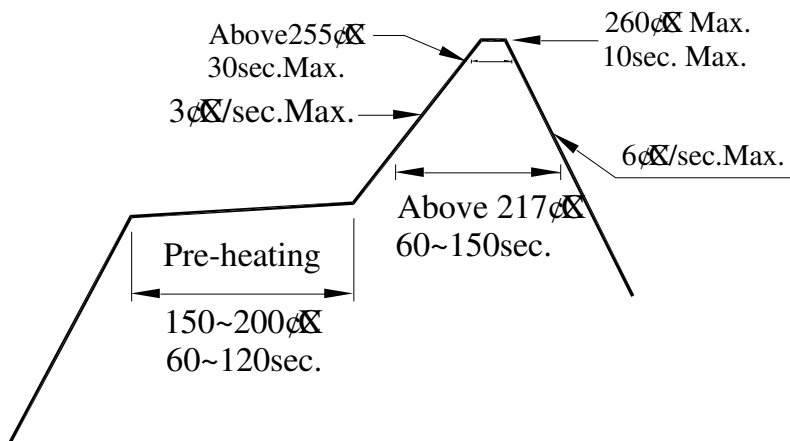

2. Storage

2.1 Moisture proof bag should only be opened immediately prior to usage.

2.2 Environment should be less than 30°C and 60% RH when moisture proof bag is opened.

2.3 After opening the package MSL Conditions stated on page 1 of this spec should not be exceeded.

2.4 If the moisture sensitivity card indicates higher than acceptable moisture, the component should be baked at min. 60deg +/-5deg for 24 hours.

3. Soldering Condition

3.1 Pb-free solder temperature profile

3.2 Reflow soldering should not be done more than two times.

3.3 When soldering, do not put stress on the LEDs during heating.

3.4 After soldering, do not warp the circuit board.

4. Soldering Iron

Each terminal is to go to the tip of soldering iron temperature less than 350°C for 3 seconds within once in less

than the soldering iron capacity 25W. Leave two seconds and more intervals, and do soldering of each terminal. Be careful because the damage of the product is often started at the time of the hand solder.

5. Repairing

Repair should not be done after the LEDs have been soldered. When repairing is unavoidable, a double-head soldering iron should be used (as below figure). It should be confirmed beforehand whether the characteristics of the LEDs will or will not be damaged by repairing.

Application Restrictions

High reliability applications such as military/aerospace, automotive safety/security systems, and medical equipment may require different product. If you have any concerns, please contact Everlight before using this product in your application. This specification guarantees the quality and performance of the product as an individual component. Do not use this product beyond the specification described in this document.

Revision History

Rev.	Modified date	File modified contents
1	2014/4/30	New Spec