



Chipsmall Limited consists of a professional team with an average of over 10 year of expertise in the distribution of electronic components. Based in Hongkong, we have already established firm and mutual-benefit business relationships with customers from,Europe,America and south Asia,supplying obsolete and hard-to-find components to meet their specific needs.

With the principle of “Quality Parts,Customers Priority,Honest Operation,and Considerate Service”,our business mainly focus on the distribution of electronic components. Line cards we deal with include Microchip,ALPS,ROHM,Xilinx,Pulse,ON,Everlight and Freescale. Main products comprise IC,Modules,Potentiometer,IC Socket,Relay,Connector.Our parts cover such applications as commercial,industrial, and automotives areas.

We are looking forward to setting up business relationship with you and hope to provide you with the best service and solution. Let us make a better world for our industry!



Contact us

Tel: +86-755-8981 8866 Fax: +86-755-8427 6832

Email & Skype: info@chipsmall.com Web: www.chipsmall.com

Address: A1208, Overseas Decoration Building, #122 Zhenhua RD., Futian, Shenzhen, China



Intrinsically Safe: EB3C Discrete Input Barriers

Key features:

- Applicable Standards
IEC60079 compliant
Dry-contact switches can be connected to the EB3C
- 8- and 16-circuit types are available in common wiring types, ideal for connection to PLCs (DC voltage only)
- Universal AC power voltage (100 to 240V AC) or 24V DC power (UL rating: 100 ~ 120V AC)
- No grounding required
- IDEC's original spring-up terminals minimize wiring time
- Installation: 35-mm-wide DIN rail mounting or direct screw mounting
- Global usage
USA: UL/FM
Europe: CE marking,
Global: IECEx ATEX
Japan: TIIS
China: CQST
Korea: KCs
Ship class: NK (Japan), KR (Korea pending)

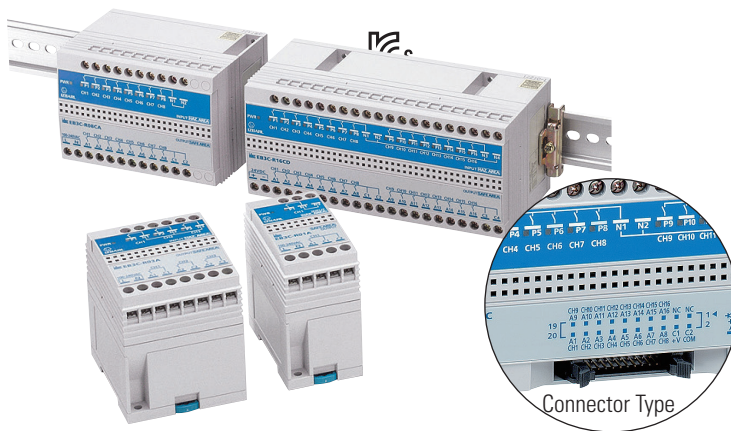

Entity Barrier Parameters

Ta=60°C, Um=250V, (Um=125V UL only), Uo=13.2V, Io=14.2mA, Po=46.9mW at each channel
Pn-Nn Io=227.2mA, Po=750mW at max 16 channels Pn-Nn

Io(mA)	14.2	28.4	42.6	56.8	71.0	85.2	99.4	113.6	127.8	142.0	156.2	170.4	184.6	198.8	213.0	227.2	Combined	
Po(mW)	46.9	93.8	140.6	187.5	234.3	281.2	328.1	375.9	421.8	468.7	515.5	562.4	609.2	656.1	702.9	750	Lo(mH)	
Co(μF)	0.67	0.65	0.63	0.61	0.59	0.57	0.55	0.53	0.51	0.49	0.47	0.44	0.42	0.39	-	-	1.0	
	0.79	0.77	0.76	0.75	0.73	0.72	0.70	0.69	0.67	0.66	0.64	0.62	0.61	0.59	0.57	0.55	0.5	
	0.94	0.94	0.94	0.94	0.94	0.94	0.94	0.93	0.92	0.91	0.90	0.88	0.87	0.86	0.85	0.84	0.2	
	0.94	0.94	0.94	0.94	0.94	0.94	0.94	0.94	0.94	0.94	0.94	0.94	0.94	0.94	0.94	0.94	0.1	
Note 1 Added to above table, the next values combined Lo and Co are allowable;																		
Io(mA)	14.2					28.4					227.2							
Lo(mH)	175*	87.5	30.0	2.5	0.55	0.25	43.5*	21.5	20.0	3.5	0.43	0.25	0.68*	0.34	0.68	0.6	0.22	0.13
Co(μF)	0.90*	0.45	0.33	0.54	0.77	0.90	0.90*	0.45	0.30	0.48	0.80	0.90	0.90*	0.45	0.45	0.49	0.80	0.90

Note 2 The intrinsic safe apparatus and wirings shall be accordance to following formulas; for example: $U_i \geq U_o$ $I_i \geq I_o$ $P_i \geq P_o$ $C_i + C_c \leq C_o$ $L_i + L_c \leq L_o$
*: Therefore, the values are allowable only at $L_i \leq 1\%L_o$ and $C_i \leq 1\%C_o$ of the intrinsic safe apparatus. (In the case of 50% of C_o and L_o parameters are applicable, the maximum capacitance allowed shall not be more than $C_o = 1 \mu F$ for IIB and $C_o = 600 nF$ for IIC.)

TIIS, NK only
Ta=60°C, Um=250V

	1 ch	16 ch
	Seperate	Common 16
Uo	13.2V	13.2V
Io	14.2mA	227.2mA
Po	46.9mW	750mW
Co	0.47μF	0.365μF
Lo	87.5mH	0.425mH

Dry Contact Switches

Dry-contact switches can be connected to the EB3C.



Spring-up Fingersafe Terminals Reduce Wiring Time

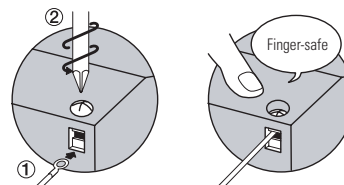

Connector Type

MIL connector on the non-hazardous side

- Easy connection to PLCs
- Wiring reduced
- Various 20-pin MIL connectors can be connected

Common Wiring for PLC Inputs

8- and 16-circuit types are available in common wiring types, ideal for connection to PLCs (DC voltage only).

OT Touchscreens

PLCs

Automation Software

Power Supplies

Sensors

Communication

Barriers

Specifications

EB3C Electrical Specifications

Ratings		See Certification Numbers table below		
Degree of Protection		IP20 (IEC60529)		
Installation Location	Discrete Input Barrier	Safe indoor place (non-hazardous area)		
		Non-intrinsically Safe Circuit		
Maximum Voltage (Um)		250V AC 50/60Hz, 250V DC 125V AC 50/60Hz, 125V DC (UL rating)		
Intrinsically Safe Circuits	Wiring Method	1-channel Separate Wiring	16-channel Common Wiring	
	Rated Operating Voltage	12V DC ±10%		
	Rated Operating Current	10 mA DC ±20%		
Non-intrinsically Safe Circuits	Relay Output	Contact Configuration	1NO	
		Rated Insulation Voltage (Ui)	250V AC (UL rating: 125V AC), 125V DC	
		Thermal Current (Ith)	3A (common terminal: 8A)	
		Contact Allowable Power	Resistive Load	AC: 750 VA, DC: 72W
			Inductive Load	AC: 750 VA (cos φ = 0.3 to 0.4) DC: 48W (L/R = 7 ms)
		Rated Load	Resistive Load	250V AC 3A, 24V DC 3A
			Inductive Load	250V AC 3A (cos φ = 0.3 to 0.4) 24V DC 2A (L/R = 7 ms)
		Minimum Applicable Load	0.1V DC, 0.1 mA (reference value)	
		Contact Resistance	50 mΩ maximum (initial value)	
		ON Time	12 ms maximum (rated voltage)	
	OFF Time	10 ms maximum (rated voltage)		
	Mechanical Life	20,000,000 operations minimum (at 18,000 operations/hour, without load)		
	Electrical Life	100,000 operations minimum (at 1,800 operations/hour, rated load)		
	Short-circuit Protection	None		
	Transistor Output	Rated Voltage	24V DC	
		Maximum Voltage	30V DC	
		Maximum Current	100 mA (connector type: 15 mA)	
		Leakage Current	0.1 mA maximum	
		Voltage Drop	1.5V maximum	
		Clamping Voltage	33V (1W)	
Inrush Current		0.5A maximum (1 sec)		
ON Time	0.1 ms maximum (resistive load)			
OFF Time	0.4 ms (typical) (resistive load)			
Short-circuit Protection	None			

EB3C General Specifications

	AC	DC
Rated Voltage	100 to 240V AC (UL rating: 100 ~ 120V AC)	24V DC
Allowable Voltage Range	85 to 264V AC (UL rating: 85 ~ 125V AC)	21.6 to 26.4V DC
Rated Frequency	50/60 Hz (allowable range: 47 to 63 Hz)	—
Inrush Current	10A (100V AC) 20A (200V AC)	10A

Dielectric Strength (1 minute, 1 mA)	Between intrinsically safe circuit and non-intrinsically safe circuit: 1526.4V AC	
	Between AC power and output terminal: 1500V AC	
	Between DC power and transistor output terminal: 1000V AC	
	Operating Temperature	-20 to +60°C (no freezing)
Storage Temperature	-20 to +60°C (no freezing)	
Operating Humidity	45 to 85% RH (no condensation)	
Atmosphere	800 to 1100 hPa	
Pollution Degree	2 (IEC60664)	
Insulation Resistance	10 MΩ minimum (500V DC megger, between the same poles as the dielectric strength)	
Vibration Resistance	Damage Limits	Panel mounting: 10 to 55 Hz, amplitude 0.75 mm DIN rail mounting: 10 to 55 Hz, amplitude 0.35 mm
	Operation Extremes (relay output only)	Panel mounting: 10 to 55 Hz, amplitude 0.5 mm DIN rail mounting: 10 to 55 Hz, amplitude 0.35 mm
Shock Resistance	Damage Limits	Panel mounting: 500 m/s ² (3 times each on X, Y, Z) DIN rail mounting: 300 m/s ² (3 times each on X, Y, Z)
	Terminal Style	M3 screw terminal
Mounting	35-mm-wide DIN rail or panel mounting (M4 screw)	
Power Consumption (approx.)	9.6 VA (EB3C-R10AN at 200V AC) 4.8 W (EB3C-R16CDN at 24V DC)	
Weight (approx.)	390g (EB3C-R16CDN)	

EB3C Certification Numbers

Certification Organization	Ratings	Certification Number
UL	Class I, II, III Div. 1 Group A, B, C, D, E, F, and G Class I, Zone 0 / [AExia] II C	E234997
FM	Class I, II, III Div. 1 Group A, B, C, D, E, F, and G Class I, Zone 0 / [AExia] II C	3047250
PTB (ATEX)	II(1)G [Exia] II C: Gas Vapour, II(1)D [Exia] III C: Dust	PTB09 ATEX2046
PTB (IEC-EX)	[Exia] II C: Gas, Vapour [Exia] III C: Dust	IECEx PTB10.0015
TIIS Japan	Relay barrier: [Exia] II C Switch (EB9Z-A) : Exia II C T6 Switch (EB9Z-A1) : Exia II B T6	TC 20541 TC15758 TC15961
Class NK	[Exia] II C	TYPE TEST No. 13T606
CQST	[Exia Ga] II C	CNEx 14.0047
KCs	Relay Barrier : [Exia] II C	14-AV4B0-0373
KR	[Exia] IIC	Pending

Class NK is Japan Shipping agency approval, Class KR is Korean shipping agency approval.

OT Touchscreens

PLCs

Automation Software

Power Supplies

Sensors

Communication

Barriers

Part Numbers

Discrete Input Barriers

Power Voltage	Connection to Non-intrinsically Safe Circuit	Input Wiring Method	Output		Number of Channels	Part Number	Weight (approx) g					
100 to 240V AC (UL rating: 100 ~ 120V AC)	Screw Terminal	Separate/Common Wiring Compatible	Relay		1	EB3C-R01AN	150					
					2	EB3C-R02AN	180					
					3	EB3C-R03AN	190					
					5	EB3C-R05AN	260					
					6	EB3C-R06AN	270					
					8	EB3C-R08AN	300					
					10	EB3C-R10AN	380					
					8	EB3C-R08CAN	280					
		Common Wiring Only	Transistor (Sink/Source)				1	EB3C-T01AN	140			
							2	EB3C-T02AN	170			
							3	EB3C-T03AN	180			
							5	EB3C-T05AN	250			
							6	EB3C-T06AN	260			
							8	EB3C-T08AN	320			
							10	EB3C-T10AN	340			
							8	EB3C-T08CKAN	260			
Common Wiring Only	Transistor				Sink	16	EB3C-T16CKAN	260				
					Source	8	EB3C-T08CSAN	260				
					16	EB3C-T16CSAN	260					
					16	EB3C-T16CSAN	260					
24V DC	Screw Terminal	Separate/Common Wiring Compatible	Relay									
								1	EB3C-R01DN	130		
								2	EB3C-R02DN	170		
								3	EB3C-R03DN	180		
								5	EB3C-R05DN	250		
								6	EB3C-R06DN	260		
								8	EB3C-R08DN	260		
								10	EB3C-R10DN	360		
		Common Wiring Only	Transistor (Sink/Source)									
										1	EB3C-T01DN	120
										2	EB3C-T02DN	160
										3	EB3C-T03DN	170
										5	EB3C-T05DN	240
										6	EB3C-T06DN	250
										8	EB3C-T08DN	250
										10	EB3C-T10DN	320
Common Wiring Only	Transistor											
								Sink	8	EB3C-T08CKDN	250	
								16	EB3C-T16CKDN	350		
								Source	8	EB3C-T08CSDN	250	
16	EB3C-T16CSDN	350										
Connector	Common Wiring											
								Sink	16	EB3C-T16CKD-CN	330	
							Source	16	EB3C-T16CSD-CN	330		

Accessories

Item	Part Number	Description
DIN Rail	BAP1000	Steel (1m long, 7.5mm high)
	BAA1000	Aluminum (1m long, 10.5mm high)
End Clip	BNL6	Medium DIN rail end clip
Static Electricity Caution Plate	EB9Z-N1	Polyester 20 (W) x 6 (H) mm

OI Touchscreens

PLCs

Automation Software

Power Supplies

Sensors

Communication

Barriers

Circuit Diagrams

Internal Circuit Block Diagrams

AC Power, Relay Output Type

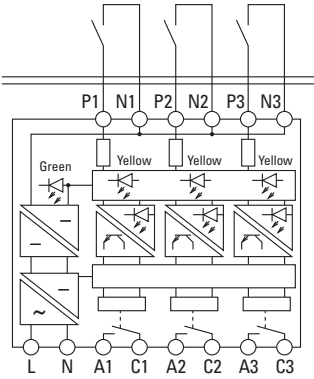

DC Power, Transistor Output Type

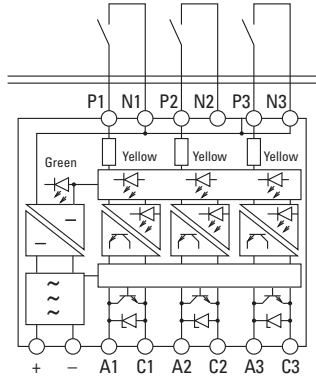

Connector Wiring, Sink Output Type

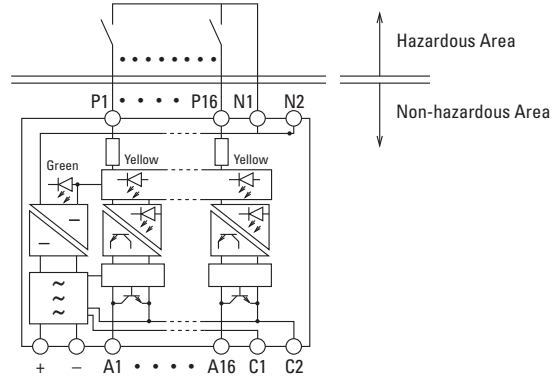

Wiring Examples

External Wiring Examples

Transistor Output Type (Ex.: EB3C-T06AN)

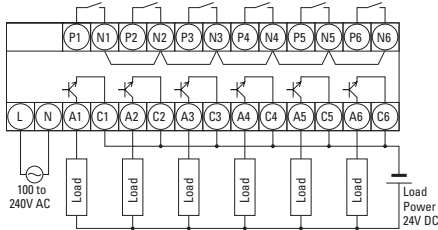

Note: On the sink/source transistor output type, terminals A can be used as a positive common line.

Transistor Sink Output Type (Ex.: EB3C-T08CKDN)

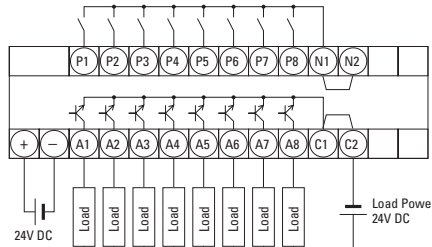

Transistor Source Output Type (Ex.: EB3C-T08CSDN)

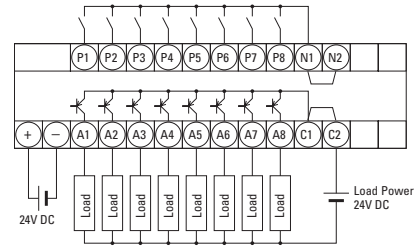

Relay Output Type (Ex.: EB3C-R06AN)

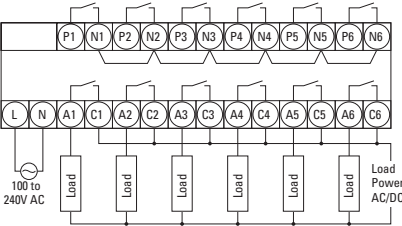

Relay Output Common Wiring Type (Ex.: EB3C-R016CDN)

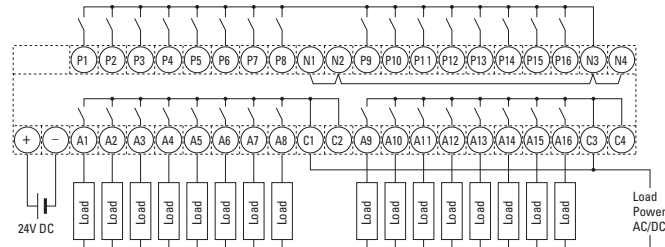

Dimensions (mm)

Screw Terminal

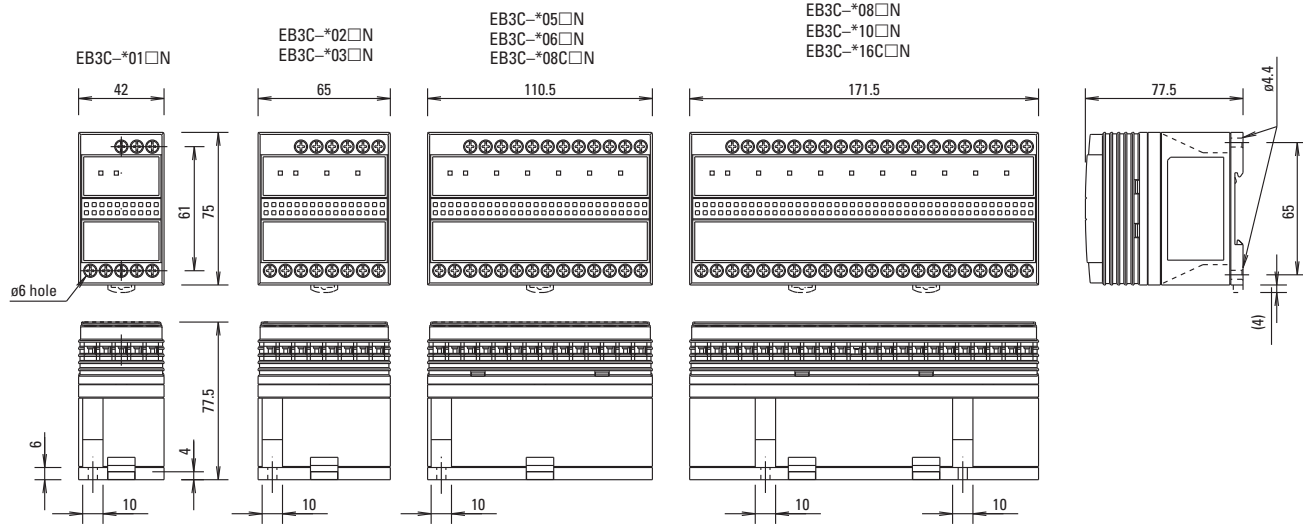

Mounting Hole Layout (Screw Mounting)

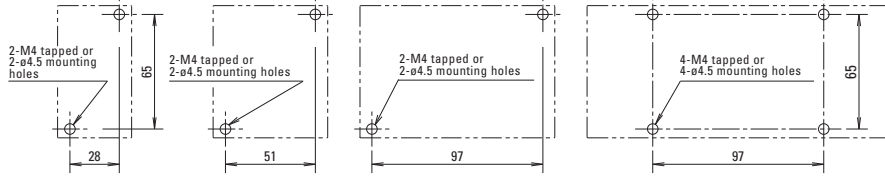

Connector Type

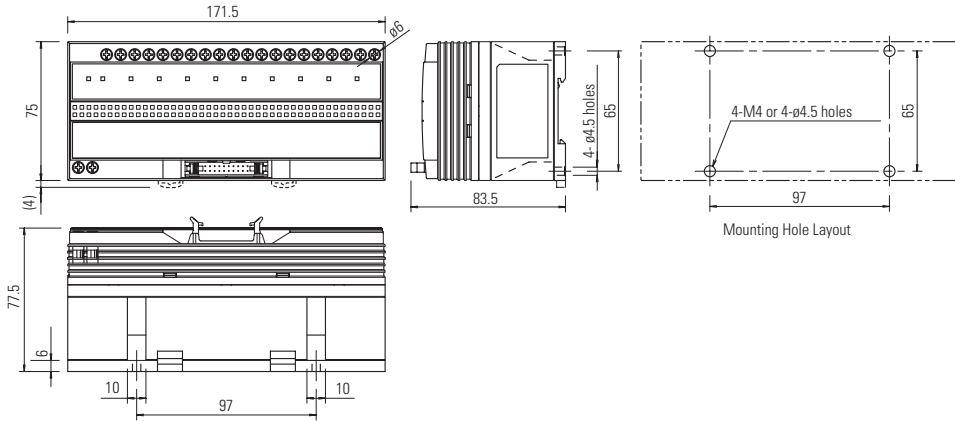

Applicable Crimping Terminal

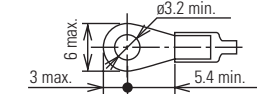

Solid Wire - Strip wire end

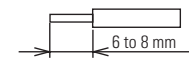

Stranded Wire - use a ferrule

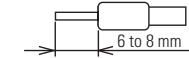

Oil Touchscreens

PLCs

Automation Software

Power Supplies

Sensors

Communication

Barriers

Connector Wiring Terminal Arrangement

EB3C-T16CKD-CN (Sink)

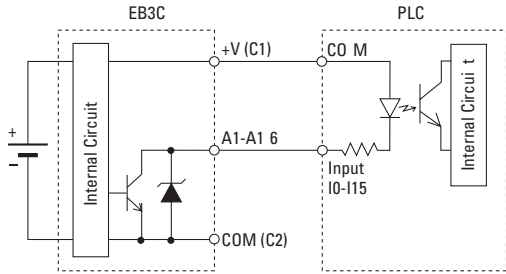
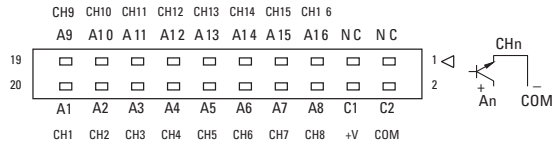

EB3C-T16CSD-CN (Source)

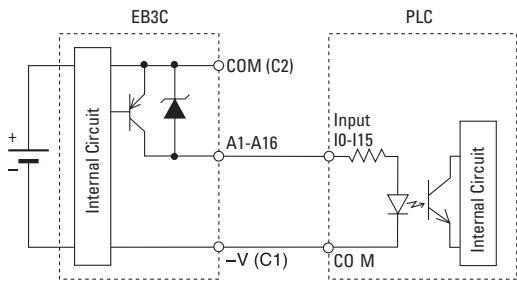
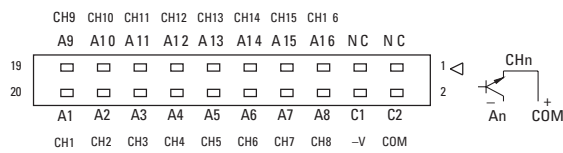

EB3C-T16CKD-CN		FC4A-N16B3		EB3C-T16CSD-CN		FC4A-N16B3	
Terminal	Output	Input	Terminal	Terminal	Output	Input	Terminal
20	A1	I0	20	20	A1	I0	20
19	A9	I10	19	19	A9	I10	19
18	A2	I11	18	18	A2	I11	18
17	A10	I11	17	17	A10	I11	17
16	A3	I2	16	16	A3	I2	16
15	A11	I12	15	15	A11	I12	15
14	A4	I3	14	14	A4	I3	14
13	A12	I13	13	13	A12	I13	13
12	A5	I4	12	12	A5	I4	12
11	A13	I14	11	11	A13	I14	11
10	A6	I5	10	10	A6	I5	10
9	A14	I15	9	9	A14	I15	9
8	A7	I6	8	8	A7	I6	8
7	A15	I16	7	7	A15	I16	7
6	A8	I7	6	6	A8	I7	6
5	A16	I17	5	5	A16	I17	5
4	+V	COM	4	4	-V	COM	4
3	NC	COM	3	3	NC	COM	3
2	COM	NC	2	2	COM	NC	2
1	NC	NC	1	1	NC	NC	1

Note: The wiring in dashed line does not affect the operation of the EB3C.
 Applicable connector is IDEC JE1S-201.
 Output power for PLC outputs is supplied by the EB3C, therefore the PLC output does not need an external power supply.

OT Touchscreens

PLCs

Automation Software

Power Supplies

Sensors

Communication

Barriers

Wiring Example of Intrinsically Safe External Inputs

1. Common Wiring (Maximum 16 circuits)

All input lines are wired to a common line inside the intrinsically safe switch (one common line per intrinsically safe circuit).

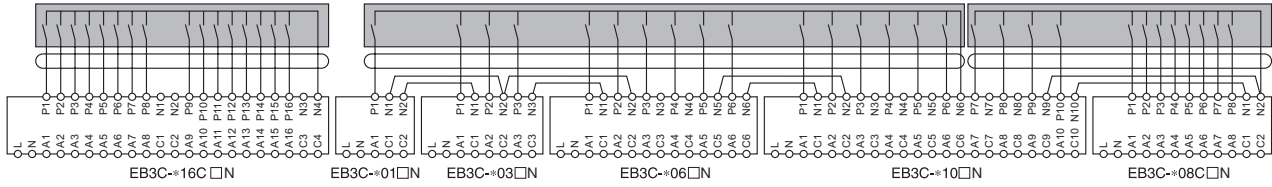

Some input lines are wired to a common line inside the intrinsically safe switches, while others are outside switches (one common line per intrinsically safe circuit).

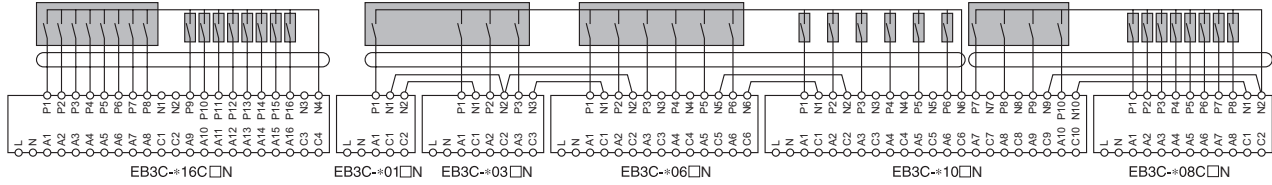

All input lines are wired to a common line outside the intrinsically safe switch (one common line per intrinsically safe circuit).

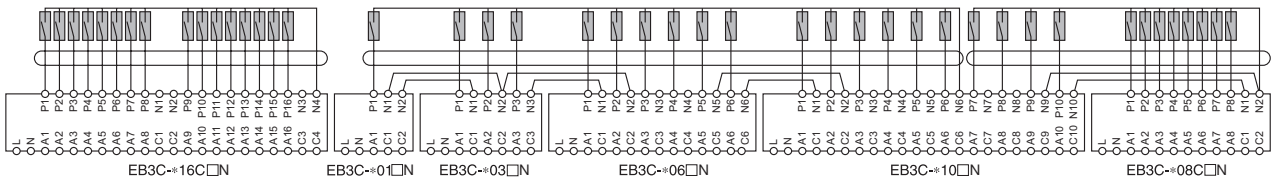

2. Separate Wiring

Each input line of the EB3C makes up one independent intrinsically safe circuit.

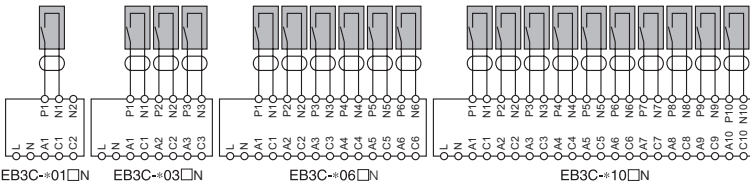
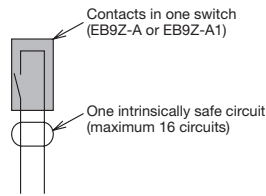
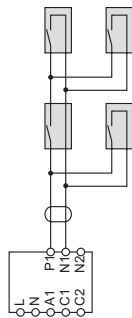

Diagram Symbols



Serial-Parallel Connection of Switches



Notes

- As shown in the diagram on the left, the required number of "contacts in one switch" (3 contacts in the example at left) can be added to the "contacts in one switch" connected to one input channel.
- Similarly, a required number of "contacts in one switch" can be added to a common line connected to multiple input channels.
- The capacitance and inductance of the added "contacts in one switch" must be included in the calculation of the wiring capacitance and inductance in "Precautions for Operation, 5. Wiring for Intrinsic Safety, (7)".
- In addition, a required number of contacts can be added in the enclosure of "contacts in one switch." In this case, however, do not include the capacitance and inductance in the calculation of the wiring capacitance and inductance. Instead, make sure that the internal capacitance (Ci) and internal inductance (Li) are within the values shown in the table "Switch Explosion-Protection Specifications (Japan only)".

OI Touchscreens

PLCs

Automation Software

Power Supplies

Sensors

Communication

Barriers

Recommended Connector Cable for Connector Types

Description	No. of Poles	Length (m)	Part Number	Shape	Applicable Type
I/O Terminal Cable	With Shield	0.5	FC9Z-H050A20		IDEC MicroSmart I/O Module
		1	FC9Z-H100A20		
		2	FC9Z-H200A20		
	Without Shield	0.5	FC9Z-H050B20		IDEC MicroSmart I/O Module
		1	FC9Z-H100B20		
		2	FC9Z-H200B20		
Cable with Crimping Terminal	20	1	BX9Z-H100E4		Screw Terminal
2	BX9Z-H200E4				
3	BX9Z-H300E4				
40-pin Cable for PLC	20	1	BX9Z-H100B		Mitsubishi A Series Input Module (positive common) ↓ EB3C-T16CKD-CN
		2	BX9Z-H200B		
		3	BX9Z-H300B		

FC9Z-H□□□A, FC9Z-H□□□B Internal Connection

Fujitsu Connector
FCN-367J024-AU/F

IDEC Connector
JE1S-201

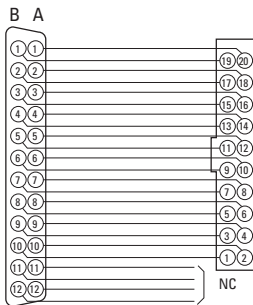

(Connection Side)

(Connection Side)

FC9Z-H□□□E4 Internal Connection

IDEC Connector
JE1S-201

Y-shaped Compression Terminal
(Marking Tube No.)

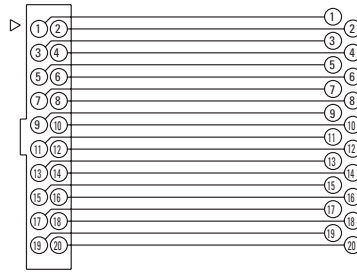

(Connection Side)

BX9Z-H□□□B Internal Connection

Fujitsu Connector
FCN-367J040-AU/F

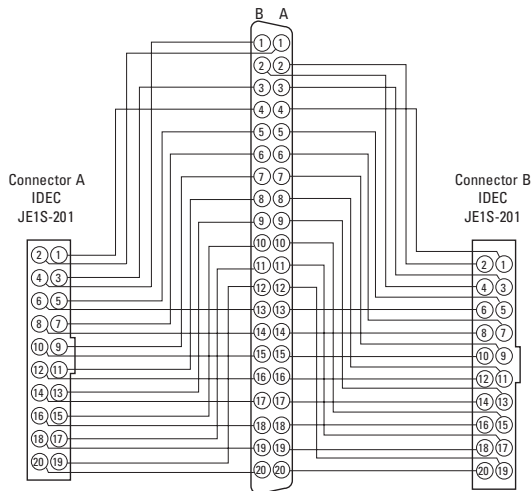

OT Touchscreens

PLCs

Automation Software

Power Supplies

Sensors

Communication

Barriers

Installing the EB3C Intrinsically Safe Barriers

1. The EB3C can be installed in any direction.
2. Install the EB3C intrinsically safe barrier in a safe area (non-hazardous area) in accordance with intrinsic safety ratings and parameters. To avoid mechanical shocks, install the EB3C in an enclosure which suppresses shocks.
3. When installing or wiring the EB3C, prevent electromagnetic and electrostatic inductions in the intrinsically safe circuit. Also prevent the intrinsically safe circuits from contacting with another intrinsically safe circuit and any other circuits.

Maintain at least 50mm clearance, or provide a metallic separating board between the intrinsically safe circuit and non-intrinsically safe circuit. When providing a metallic separating board, make sure that the board fits closely to the enclosure (top, bottom, and both sides). Allowable clearance between the enclosure and board is 1.5mm at the maximum.

The clearance of 50mm between the intrinsically safe circuit and non-intrinsically safe circuit may not be sufficient when a motor circuit or high-voltage circuit is installed nearby. In this case, provide a wider clearance between the circuits referring to 5 (3) "Minimum Parallel Distance between the Intrinsically Safe Circuit and Other Circuits."

4. In order to prevent contact between intrinsically safe circuits and non-intrinsically safe circuits, mount EB3C units with terminals arranged in the same direction.

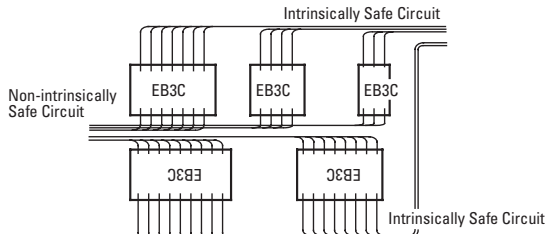

5. Maintain at least 6mm (or 3mm according to IEC60079-11: 1999) clearance between the terminal of an intrinsically safe circuit and the grounded metal part of a metal enclosure, and between the relay terminal block of an intrinsically safe circuit and the grounded metal part of a metal enclosure.
6. For installing the EB3C, mount on a 35mm-wide DIN rail or directly on a panel using screws. Make sure to install securely to withstand vibration. When mounting on a DIN rail, push in the clamp completely. Use the BNL6 end clips on both sides of the EB3C to prevent from moving sideways.
7. Excessive extraneous noise may cause malfunction and damage to the EB3C. When extraneous noise activates the voltage limiting circuit (thyristor), remove the noise source and restore the power.

Terminal Wiring

1. Using a ø5.5mm or smaller screw driver, tighten the terminal screws (including unused terminal screws) to a torque of 0.6 to 1.0N·m (recommended value).
2. Make sure that IP20 is achieved when wiring. Use insulation tubes on bare crimping terminals.
3. To prevent disengaged wires from contacting with other intrinsically safe circuits, bind together the wires of one intrinsically safe circuit.
4. When the adjacent terminal is connected to another intrinsically safe circuit, provide an insulation distance of at least 6mm.

Switches in the Hazardous Area

1. A switch contains the switch contact, enclosure, and internal wiring. A switch contact refers to an ordinary switching device which consists of contacts only, such as a pushbutton switch. See below.

Applicable Switches

Control Switches	Push-pull Switches	Pushbutton, Foot, Trigger, Rocker, Grip
	Twisting Switches	Rotary, Selector, Cam, Drum, Thumb wheel
	Lever and Slide Switches	Toggle, Multidirectional, Wobble stick, Lever, Slide switch
Sensing Switches	Displacement Switches	Microswitch, Limit, Magnetic proximity, Door, Reed, Mercury
	Level Switches	Liquid level
	Others	Pressure, Temperature

Note: For installation in hazardous areas and connection to the EB3C, use switches which are certified, approved, or considered to be simple apparatus in relevant standards in each country.

2. When the switch has internal wiring or lead wire, make sure that the values of internal inductance (Li) and capacitance (Ci) are within the certified values.
3. Enclose the switch contact's bare, live part in an enclosure of IP20 or higher protection.
4. Depending on the explosion-protection specifications according to TIIS, the exposed area of the plastic switch operator is limited as follows:
 Exia II CT6 (EB9Z-A): 20cm² maximum
 Exia II BT6 (EB9Z-A1): 100cm² maximum
5. Attach the certification mark supplied with the EB3C on the EB9Z-A or EB9Z-A1 switch (for Japanese applications).
6. When the switch operator of the plastic enclosure has a wider exposed area than the following limits, attach a caution label.

Caution
 To prevent electrostatic charges, do not rub the switch surface during operation.
 Use a soft cloth dipped with water for cleaning.

Caution Label Example

- II C: 20 cm² maximum
- II B: 100 cm² maximum

7. For the 1-circuit separate wiring, a resistor to prevent reed switch contact welding and an LED miniature pilot light can be connected in series with the contact. See below.

Applicable Resistor Ratings

Resistance	100Ω maximum
Rated Wattage	0.5 to 3W
Type	Metal (oxide) film resistors

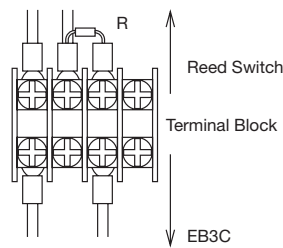

IPL1 series LED miniature pilot lights Output Specifications

1. When wiring the output from the EB3C, connect the non-intrinsically safe circuit to terminals A and C. The EB3C output circuit is not equipped with short-circuit protection. If required, provide a protection in the external circuit.
2. Relay Output

Some types of loads generate reverse emf (such as solenoids) or cause a large inrush current (incandescent lamps), resulting in a shorter operation life of output relay contacts. The operation life of contacts can be extended by preventing the reverse emf using a diode, RC, or varistor, or by suppressing the inrush current using a resistor or RL.

Contacts are made of gold-clad silver. When using at a small current and a low voltage (reference value: 0.1mA, 0.1V), test the contact on the actual circuit in advance.

OI Touchscreens

PLCs

Automation Software

Power Supplies

Sensors

Communication

Barriers

3. Transistor Output

When connecting a small load, the load may not turn off because of a leakage current, even though the transistor output is turned off. If this is the case, connect a resistor in parallel with the load to bypass the leakage current.

When an excessively high voltage (clamps at 33V, 1W) or a reverse voltage is applied to the output terminals, the clamping circuit or output transistor may be damaged.

When driving an inductive load, be sure to connect a diode across the load to absorb reverse emf.

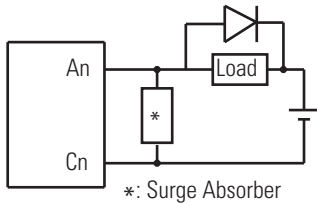

Example of Overvoltage Absorption Circuit

4. In the common wiring only types, the output terminals are not isolated from each other.
5. When connecting the connector type EB3C's in parallel, use one power supply to power the EB3C's. Do not connect any wiring to the C1 and C2 terminals.

Wiring for Intrinsic Safety

1. The voltage applied on the general circuit connected to the non-intrinsically safe circuit terminals of the EB3C relay barrier must be 250V AC, 50/60Hz, or 250V DC at the maximum under any conditions, including the voltage of the input power and the internal circuit.
2. When wiring, take into consideration the prevention of electromagnetic and electrostatic charges on intrinsically safe circuits. Also, prevent intrinsically safe circuits from contacting with other circuits.
3. The intrinsically safe circuits must be separated from non-intrinsically safe circuits. Contain intrinsically safe circuits in a metallic tube or duct, or separate the intrinsically safe circuits referring to the table below.

Note: Cables with a magnetic shield, such as a metallic sheath, prevent electromagnetic induction and electrostatic induction, however, a non-magnetic shield prevents electrostatic induction only. For non-magnetic shields, take a preventive measure against electromagnetic induction.

Finely twisted pair cables prevent electromagnetic induction. Adding shields to the twisted pair cables provides protection against electrostatic induction.

Minimum Parallel Distance between the Intrinsically Safe Circuit and Other Circuits (mm)

Voltage and Current of Other Circuits	Over 100A	100A or less	50A or less	10A or less
Over 440V	2000	2000	2000	2000
440V or less	2000	600	600	600
220V or less	2000	600	600	500
110V or less	2000	600	500	300
60V or less	2000	500	300	150

4. When identifying intrinsically safe circuits by color, use light blue terminal blocks and cables.
5. When using two or more EB3C's to set up one intrinsically safe circuit in the common wiring configuration, interconnect two neutral terminals (N1 through N10) on each EB3C between adjacent EB3C's in parallel.
6. Make sure that the power of the EB3C and contact are turned off before starting inspection or replacement.
7. When wiring the intrinsically safe circuit, determine the distance to satisfy the wiring parameters shown below. Note that parameters are different

between separate wiring and common wiring.

- a. Wiring capacitance $C_w \leq C_o - (C_i + N \times 2 \text{ nF})$
 Co: Maximum external capacitance of the EB3C
 Ci: Internal capacitance of the switch
 N: The number of switches connected in series or parallel (the number is infinite)
- b. Wiring inductance $L_w \leq L_o - (L_i + N \times 5 \text{ } \mu\text{H})$
 Lo: Maximum external inductance of the EB3C
 Li: Internal inductance of the switch
 N: The number of switches connected in series or parallel (the number is infinite)
- c. Wiring resistance $\leq R_w$
 Rw: Allowable wiring resistance
- d. Allowable wiring distance D (km) is the smallest value of those calculated from the capacitance, inductance, and resistance.
 $D \leq C_w/C$ C (nF/km): Capacitance of cable per km
 $D \leq L_w/L$ L (mH/km): Inductance of cable per km
 $D \leq R_w/2R$ R (Ω /km): Resistance of cable per km

Note: For the details of wiring the intrinsically safe circuits, refer to a relevant test guideline for explosion-proof electric equipment in each country.

8) Applicable Wire Size

0.5 to 2.0mm² (AWG20 to AWG14): two wires

However, one wire for 2.0 mm² (AWG14)

Mounting Bracket

The following mounting brackets can be used to install the EB3C relay barriers and EB3L lamp barriers on the mounting holes of IBRC contact signal transducer, IBPL pilot relay barrier, and IBZ buzzer.

No. of Channels	Part No.	Dimension (mm)		
		A	B	C
1	EB9Z-K01	28.0	44.0	61.0
2	EB9Z-K02	51.0	59.5	76.0
3	EB9Z-K03	51.0	75.0	91.5
5	EB9Z-K05	97.0	105.0	122.0
6	EB9Z-K06	97.0	120.0	137.0
10	EB9Z-K10	97.0	181.0	198.0

Dimensions

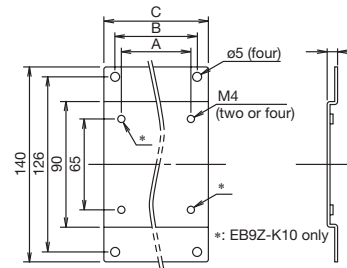

All dimensions in mm.