



Chipsmall Limited consists of a professional team with an average of over 10 year of expertise in the distribution of electronic components. Based in Hongkong, we have already established firm and mutual-benefit business relationships with customers from,Europe,America and south Asia,supplying obsolete and hard-to-find components to meet their specific needs.

With the principle of "Quality Parts,Customers Priority,Honest Operation,and Considerate Service",our business mainly focus on the distribution of electronic components. Line cards we deal with include Microchip,ALPS,ROHM,Xilinx,Pulse,ON,Everlight and Freescale. Main products comprise IC,Modules,Potentiometer,IC Socket,Relay,Connector.Our parts cover such applications as commercial,industrial, and automotives areas.

We are looking forward to setting up business relationship with you and hope to provide you with the best service and solution. Let us make a better world for our industry!



Contact us

Tel: +86-755-8981 8866 Fax: +86-755-8427 6832

Email & Skype: info@chipsmall.com Web: www.chipsmall.com

Address: A1208, Overseas Decoration Building, #122 Zhenhua RD., Futian, Shenzhen, China



EBM80TZ025 Datasheet

Technical Specifications

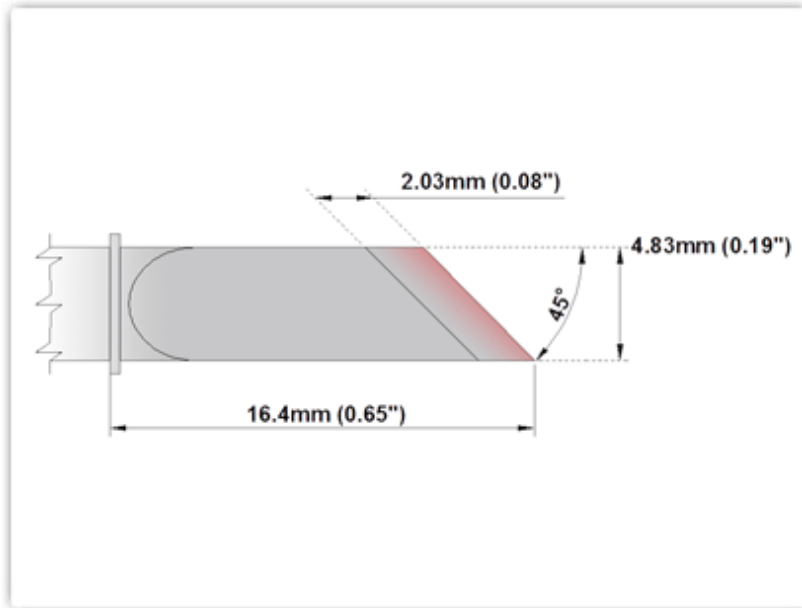

EBM80TZ025

**Tweezers Cartridge Pair - Knife
Tinned area 2.03mm (0.08")**

Tip Style: Tweezers
Tip Width: 4.83mm (0.19")
Tip Length: 16.40mm (0.65")

800 Type Cartridge ¹ :	420°C - 475°C
RoHS Compliant ² / Lead Free:	YES
For Use With:	EB-9000S-1, EB-9000S-2, MX500 and MX5000

Material Composition

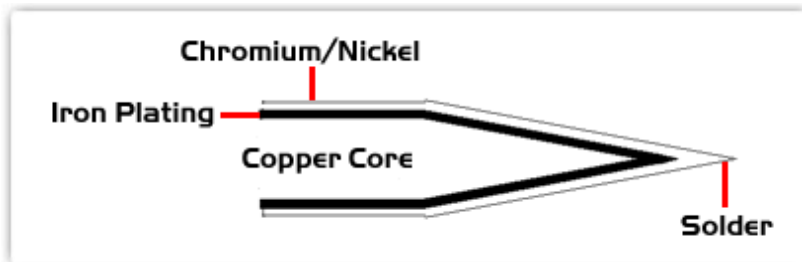

**All components
are RoHS
compliant and
Lead-Free.**

¹ Easy Braid Co. tip cartridges will typically idle within a temperature range of +/-1.1°C. However, there is variation in idle temperature across tip geometries within an individual temperature series. Easy Braid Co. offers a wide variety of tip geometries from 0.25mm fine point tip to 5mm chisel. The length and geometry of a tip will have an influence on the tip idle temperature. To accurately measure idle temperature it will depend greatly on the measurement method, technique and equipment used. Two different methods or the use of alternative equipment will produce different test results.

² Please refer to <http://www.rohs.gov.uk> for details on RoHS Compliance.