



Chipsmall Limited consists of a professional team with an average of over 10 year of expertise in the distribution of electronic components. Based in Hongkong, we have already established firm and mutual-benefit business relationships with customers from,Europe,America and south Asia,supplying obsolete and hard-to-find components to meet their specific needs.

With the principle of “Quality Parts,Customers Priority,Honest Operation,and Considerate Service”,our business mainly focus on the distribution of electronic components. Line cards we deal with include Microchip,ALPS,ROHM,Xilinx,Pulse,ON,Everlight and Freescale. Main products comprise IC,Modules,Potentiometer,IC Socket,Relay,Connector.Our parts cover such applications as commercial,industrial, and automotives areas.

We are looking forward to setting up business relationship with you and hope to provide you with the best service and solution. Let us make a better world for our industry!



## Contact us

Tel: +86-755-8981 8866 Fax: +86-755-8427 6832

Email & Skype: info@chipsmall.com Web: www.chipsmall.com

Address: A1208, Overseas Decoration Building, #122 Zhenhua RD., Futian, Shenzhen, China



# EE-SPW311/411

## Through-beam Photomicrosensor with a sensing distance as long as 1 m.

- Easy operation monitoring with bright light indicator.
- Wide operating voltage range: 5 to 24 VDC
- Light modulation effectively reduces external light interference.
- Easy-to-wire connector assures ease of maintenance.





 Be sure to read *Safety Precautions* on page 3.



### Ordering Information

#### Sensors

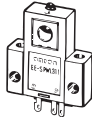
 Infrared light

Appearance	Sensing method	Sensing distance	Output type	Output configuration	Model
	Through-beam type	 1m	NPN output	Dark-ON	<b>EE-SPW311</b>
				Light-ON	<b>EE-SPW411</b>

\* Both an EE-1006L Connector with Cable for the Emitter and an EE-1006D Connector with Cable for the Receiver are included with the Photomicrosensor. Refer to *Accessories* when using non-standard connectors, including Robot Cables and PNP Adapters.

## Ratings and Specifications

Item	Models	EE-SPW311, EE-SPW411
Sensing distance		1 m
Sensing object		Opaque: 5 mm dia. min.
Directional angle		5 to 20°
Light source		GaAs infrared LED (pulse lighting) with a peak wavelength of 940 nm
Indicator *1		Light indicator (red)
Supply voltage		5 (-5%) to 24 (+10%) VDC, ripple (p-p): 5% max.
Current consumption		Emitter: 20 mA max., Receiver: 20 mA max.
Control output		NPN open collector: Load power supply voltage: 5 to 24 VDC Load current: 100 mA max. OFF current: 0.5 mA max. 100 mA load current with a residual voltage of 0.8 V max. 10 mA load current with a residual voltage of 0.4 V max.
Response frequency *2		100 Hz min.
Ambient illumination		3,000 lx max. with incandescent light on the surface of the receiver
Ambient temperature range		Operating: -10 to +55°C Storage: -25 to +65°C
Ambient humidity range		Operating: 5% to 85% Storage: 5% to 95%
Vibration resistance		Destruction: 200 to 2,000 Hz (peak acceleration: 100 m/s <sup>2</sup> ) 1.5-mm double amplitude for 2 h (4-min periods) each in X, Y, and Z directions
Shock resistance		Destruction: 500 m/s <sup>2</sup> for 3 times each in X, Y, and Z directions
Degree of protection		IEC IP60
Connecting method		Special connector (soldering not possible)
Weight (packaged)		Approx. 8.8 g
Material	Case	Polybutylene phthalate (PBT)
	Lens	Polycarbonate
Accessories		EE-1006L/D Connectors with Cables, Instruction Manual

\*1. The indicator is a GaP red LED (peak wavelength: 700 nm).  
\*2. The response frequency was measured by detecting the following rotating disk.

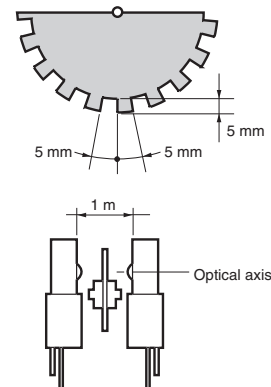

## Engineering Data (Reference Value)

Receiver Output Excess Gain Vs. Sensing Distance Characteristics

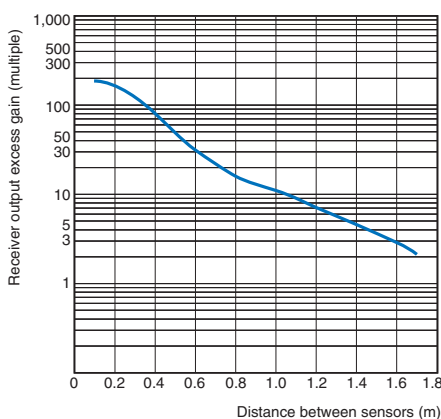

Parallel Movement Characteristics

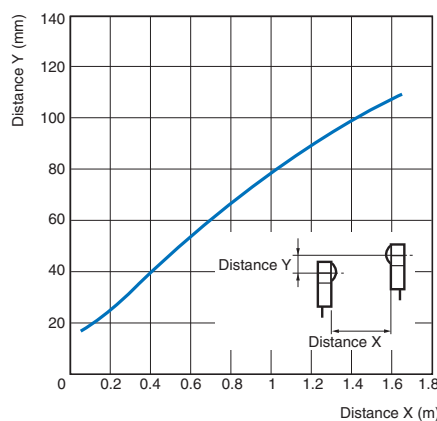

## I/O Circuit Diagrams

### NPN Output

Model	Output configuration	Timing charts	Output circuit
EE-SPW411	Light-ON		
EE-SPW311	Dark-ON		

## Safety Precautions

Refer to *Warranty and Limitations of Liability*.

### ⚠ WARNING

This product is not designed or rated for ensuring safety of persons either directly or indirectly. Do not use it for such purposes.



### Precautions for Correct Use

Make sure that this product is used within the rated ambient environment conditions.

#### ● Wiring

- Connection is made using a connector. Do not solder to the pins (leads).
- When extending the cable, use an extension cable with conductors having a total cross-section area of 0.3 mm<sup>2</sup>. The total cable length must be less than 10 m.

#### ● Axis Adjustment

- (1) Tentatively mount the emitter and receiver so that the center of each lens is in a single line.

Side view

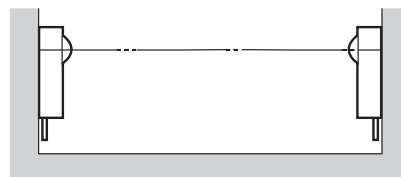

Top view



- (2) Turn ON the emitter and receiver after making sure that they have been wired correctly. When power is turned ON, the light indicator on the receiver will light. Make sure that the light indicator is OFF when an object intercepts the optical axis and that the light indicator lights again when the object is removed.

- (3) Fix the position of the receiver (or emitter) securely, move the emitter (or receiver) horizontally and vertically to check the range in which the operation indicator is lit. Then locate the emitter (or receiver) in the center of the range and fix the position securely.

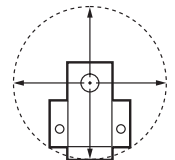

## Dimensions

Tolerance class IT16 applies to dimensions in this datasheet unless otherwise specified.

## Sensors

EE-SPW311  
EE-SPW411

### Emitter (EE-SPWL□11)

### Receiver (EE-SPWD□11)

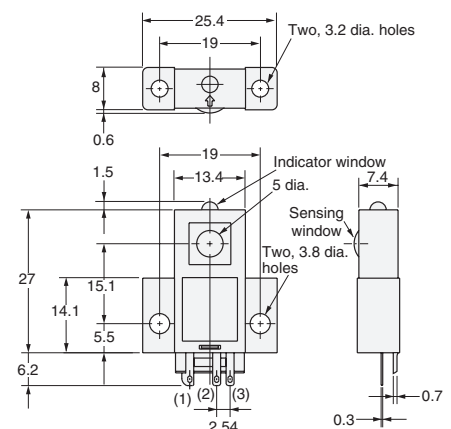
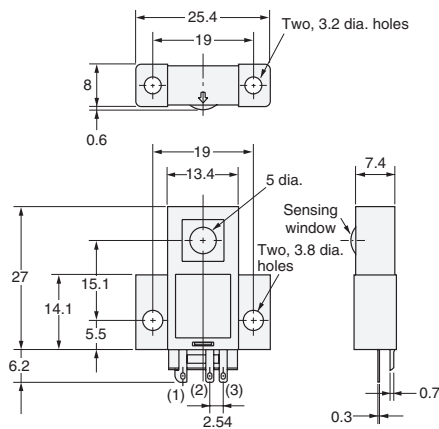
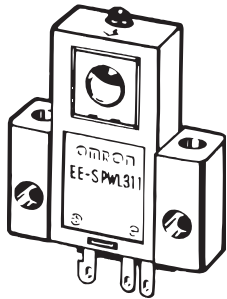

#### Terminal Arrangement

(1)	+	Vcc
(2)	---	Vacant
(3)	-	GND (0 V)

#### Terminal Arrangement

(1)	+	Vcc
(2)	OUT	OUTPUT
(3)	-	GND (0 V)

## Accessories (Included)

### Connector with Cable for Emitter

EE-1006L

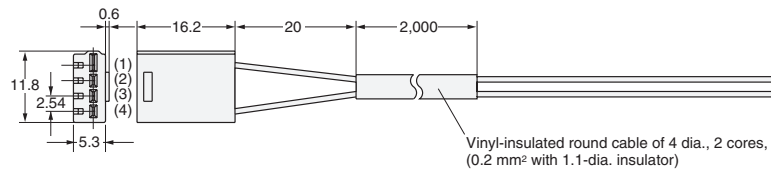
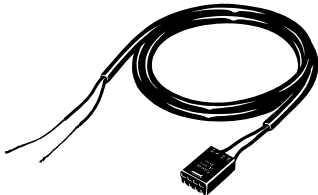

(1)	Brown	+
(4)	Blue	-

### Connector with Cable for Receiver

EE-1006D

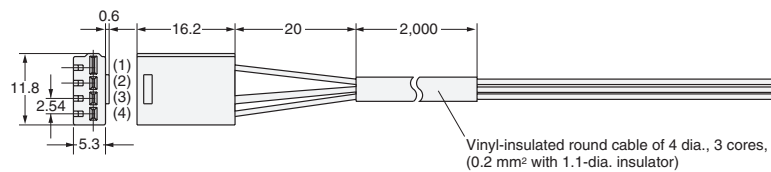
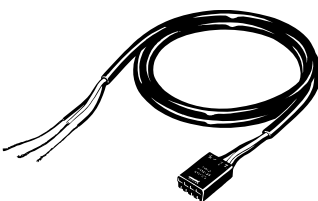

(1)	Brown	+
(3)	Black	OUT
(4)	Blue	-

Note: These cables can also be ordered separately.

\* Refer to *Accessories* for details.

## Terms and Conditions Agreement

### Read and understand this catalog.

Please read and understand this catalog before purchasing the products. Please consult your OMRON representative if you have any questions or comments.

### Warranties.

(a) Exclusive Warranty. Omron's exclusive warranty is that the Products will be free from defects in materials and workmanship for a period of twelve months from the date of sale by Omron (or such other period expressed in writing by Omron). Omron disclaims all other warranties, express or implied.

(b) Limitations. OMRON MAKES NO WARRANTY OR REPRESENTATION, EXPRESS OR IMPLIED, ABOUT NON-INFRINGEMENT, MERCHANTABILITY OR FITNESS FOR A PARTICULAR PURPOSE OF THE PRODUCTS. BUYER ACKNOWLEDGES THAT IT ALONE HAS DETERMINED THAT THE PRODUCTS WILL SUITABLY MEET THE REQUIREMENTS OF THEIR INTENDED USE.

Omron further disclaims all warranties and responsibility of any type for claims or expenses based on infringement by the Products or otherwise of any intellectual property right. (c) Buyer Remedy. Omron's sole obligation hereunder shall be, at Omron's election, to (i) replace (in the form originally shipped with Buyer responsible for labor charges for removal or replacement thereof) the non-complying Product, (ii) repair the non-complying Product, or (iii) repay or credit Buyer an amount equal to the purchase price of the non-complying Product; provided that in no event shall Omron be responsible for warranty, repair, indemnity or any other claims or expenses regarding the Products unless Omron's analysis confirms that the Products were properly handled, stored, installed and maintained and not subject to contamination, abuse, misuse or inappropriate modification. Return of any Products by Buyer must be approved in writing by Omron before shipment. Omron Companies shall not be liable for the suitability or unsuitability or the results from the use of Products in combination with any electrical or electronic components, circuits, system assemblies or any other materials or substances or environments. Any advice, recommendations or information given orally or in writing, are not to be construed as an amendment or addition to the above warranty.

See <http://www.omron.com/global/> or contact your Omron representative for published information.

### Limitation on Liability; Etc.

OMRON COMPANIES SHALL NOT BE LIABLE FOR SPECIAL, INDIRECT, INCIDENTAL, OR CONSEQUENTIAL DAMAGES, LOSS OF PROFITS OR PRODUCTION OR COMMERCIAL LOSS IN ANY WAY CONNECTED WITH THE PRODUCTS, WHETHER SUCH CLAIM IS BASED IN CONTRACT, WARRANTY, NEGLIGENCE OR STRICT LIABILITY.

Further, in no event shall liability of Omron Companies exceed the individual price of the Product on which liability is asserted.

### Suitability of Use.

Omron Companies shall not be responsible for conformity with any standards, codes or regulations which apply to the combination of the Product in the Buyer's application or use of the Product. At Buyer's request, Omron will provide applicable third party certification documents identifying ratings and limitations of use which apply to the Product. This information by itself is not sufficient for a complete determination of the suitability of the Product in combination with the end product, machine, system, or other application or use. Buyer shall be solely responsible for determining appropriateness of the particular Product with respect to Buyer's application, product or system. Buyer shall take application responsibility in all cases.

NEVER USE THE PRODUCT FOR AN APPLICATION INVOLVING SERIOUS RISK TO LIFE OR PROPERTY OR IN LARGE QUANTITIES WITHOUT ENSURING THAT THE SYSTEM AS A WHOLE HAS BEEN DESIGNED TO ADDRESS THE RISKS, AND THAT THE OMRON PRODUCT(S) IS PROPERLY RATED AND INSTALLED FOR THE INTENDED USE WITHIN THE OVERALL EQUIPMENT OR SYSTEM.

### Programmable Products.

Omron Companies shall not be responsible for the user's programming of a programmable Product, or any consequence thereof.

### Performance Data.

Data presented in Omron Company websites, catalogs and other materials is provided as a guide for the user in determining suitability and does not constitute a warranty. It may represent the result of Omron's test conditions, and the user must correlate it to actual application requirements. Actual performance is subject to the Omron's Warranty and Limitations of Liability.

### Change in Specifications.

Product specifications and accessories may be changed at any time based on improvements and other reasons. It is our practice to change part numbers when published ratings or features are changed, or when significant construction changes are made. However, some specifications of the Product may be changed without any notice. When in doubt, special part numbers may be assigned to fix or establish key specifications for your application. Please consult with your Omron's representative at any time to confirm actual specifications of purchased Product.

### Errors and Omissions.

Information presented by Omron Companies has been checked and is believed to be accurate; however, no responsibility is assumed for clerical, typographical or proofreading errors or omissions.

2013.12

In the interest of product improvement, specifications are subject to change without notice.

**OMRON Corporation**  
Industrial Automation Company

<http://www.ia.omron.com/>

(c)Copyright OMRON Corporation 2013 All Right Reserved.