



Chipsmall Limited consists of a professional team with an average of over 10 year of expertise in the distribution of electronic components. Based in Hongkong, we have already established firm and mutual-benefit business relationships with customers from,Europe,America and south Asia,supplying obsolete and hard-to-find components to meet their specific needs.

With the principle of “Quality Parts,Customers Priority,Honest Operation,and Considerate Service”,our business mainly focus on the distribution of electronic components. Line cards we deal with include Microchip,ALPS,ROHM,Xilinx,Pulse,ON,Everlight and Freescale. Main products comprise IC,Modules,Potentiometer,IC Socket,Relay,Connector.Our parts cover such applications as commercial,industrial, and automotives areas.

We are looking forward to setting up business relationship with you and hope to provide you with the best service and solution. Let us make a better world for our industry!



Contact us

Tel: +86-755-8981 8866 Fax: +86-755-8427 6832

Email & Skype: info@chipsmall.com Web: www.chipsmall.com

Address: A1208, Overseas Decoration Building, #122 Zhenhua RD., Futian, Shenzhen, China



Photomicrosensor (Transmissive) EE-SX460-P1

⚠ Be sure to read *Precautions* on page 25.

■ Dimensions

Note: All units are in millimeters unless otherwise indicated.

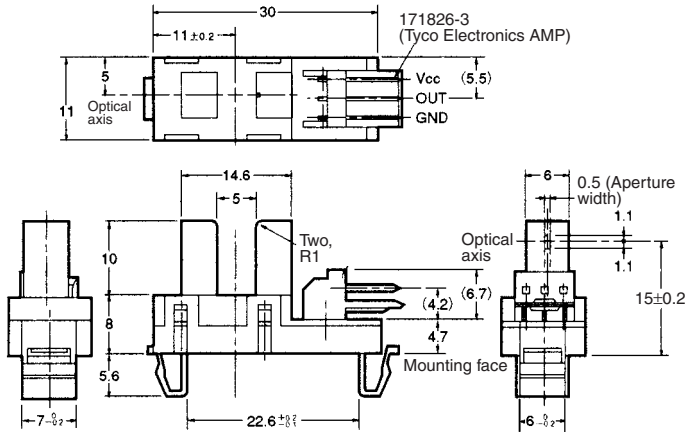

Internal Circuit

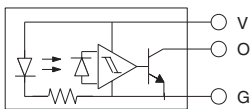

Unless otherwise specified, the tolerances are as shown below.

Dimensions	Tolerance
3 mm max.	±0.3
3 < mm ≤ 6	±0.375
6 < mm ≤ 10	±0.45
10 < mm ≤ 18	±0.55
18 < mm ≤ 30	±0.65

Terminal No.	Name
V	Power supply (V _{CC})
O	Output (OUT)
G	Ground (GND)

Recommended Mating Connectors:
 Tyco Electronics AMP 171822-3 (crimp connector)
 172142-3 (crimp connector)
 OMRON EE-1005 (with harness)

■ Electrical and Optical Characteristics (Ta = 25°C, V_{CC} = 5 V±10%)

Item	Symbol	Value	Condition
Current consumption	I _{CC}	30 mA max.	With and without incident
Low-level output voltage	V _{OL}	0.3 V max.	I _{OUT} = 16 mA with incident
High-level output voltage	V _{OH}	(V _{CC} × 0.9) V min.	V _{OUT} = V _{CC} without incident, R _L = 47 kΩ
Response frequency	f	3 kHz min.	V _{OUT} = V _{CC} , R _L = 47 kΩ (see note)

Note: The value of the response frequency is measured by rotating the disk as shown below.

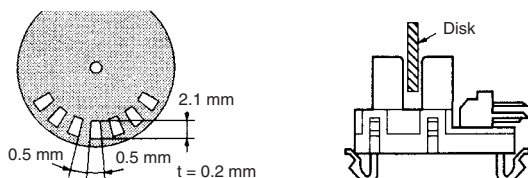

■ Features

- Snap-in mounting model.
- Mounts to 0.8- to 1.6-mm-thick panels.
- High resolution (aperture width of 0.5 mm)
- With a 5-mm-wide slot.
- Photo IC output signals directly connect with C-MOS and TTL.
- Connects to Tyco Electronics AMP's EI-series connectors.

■ Absolute Maximum Ratings (Ta = 25°C)

Item	Symbol	Rated value	
Power supply voltage	V _{CC}	10 V	
Output voltage	V _{OUT}	28 V	
Output current	I _{OUT}	16 mA	
Permissible output dissipation	P _{OUT}	250 mW (see note)	
Ambient temperature	Operating	T _{opr}	-20°C to 75°C
	Storage	T _{stg}	-40°C to 85°C
Soldering temperature	T _{sol}	---	

Note: Refer to the temperature rating chart if the ambient temperature exceeds 25°C.

Engineering Data

Output Allowable Dissipation vs. Ambient Temperature Characteristics

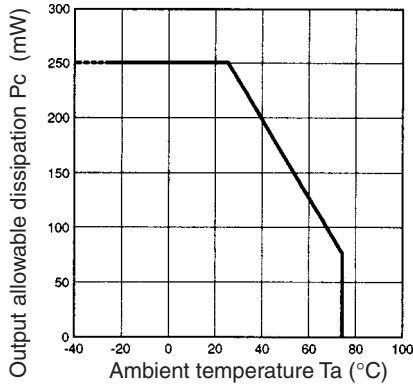

Sensing Position Characteristics (Typical)

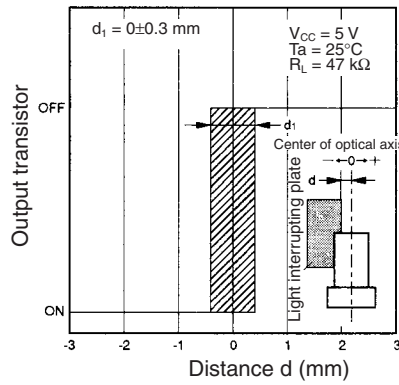

Sensing Position Characteristics (Typical)

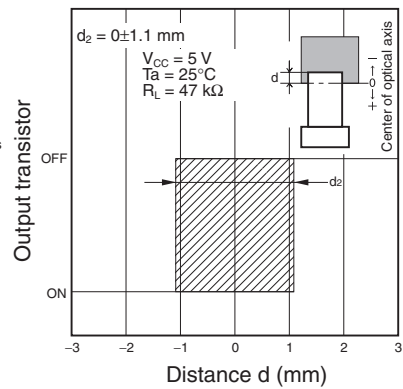

EE-1005 Connector

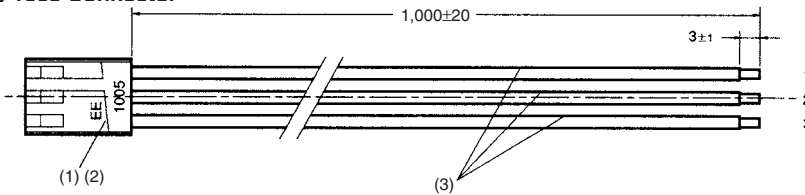

No.	Name	Model	Quantity	Maker
1	Receptacle housing	171822-3	1	Tyco Electronics AMP
2	Receptacle contact	170262-1	3	Tyco Electronics AMP
3	Lead wire	UL1007 AWG24	3	---

Wiring

Connector circuit no.	Lead wire color	Output when connected to EE-SX460-P1
1	Red	V_{CC}
2	Orange	OUT
3	Yellow	GND

Recommended Mounting Hole Dimensions and Mounting and Dismounting Method

Dismounting by Hand

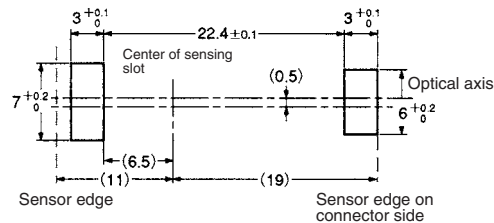

Squeeze the mounting tabs as shown in the following illustration and press the mounting tabs upwards.

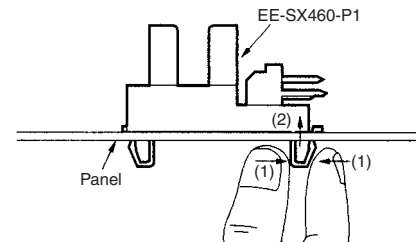

The Photomicrosensor can be mounted to 0.8- to 1.6-mm-thick panels.

Refer to the above mounting hole dimensions and open the mounting holes in the panel to which the Photomicrosensor will be mounted.

Insert into the holes the Photomicrosensor's mounting portions with a force of three to five kilograms but do not press in the Photomicrosensor at one time. The Photomicrosensor can be easily mounted by inserting the mounting portions halfway and then slowly pressing the Photomicrosensor onto the panel.

There are two ways to dismount the Photomicrosensor. Refer to the following.

Pressed mounting holes are ideal for mounting the Photomicrosensor. When mounting the Photomicrosensor to a panel that has pressed mounting holes for the Photomicrosensor, be sure to mount the Photomicrosensor on the pressing side of the panel, otherwise it may be difficult to mount the Photomicrosensor and an insertion force of five to six kilograms may be required.

When mounting the Photomicrosensor to a panel that has mounting holes opened by pressing, make sure that the mounting holes have no burrs, otherwise the lock mechanism of the Photomicrosensor will not work perfectly. After mounting the Photomicrosensor to a panel, be sure to check if the lock mechanism is working perfectly.

Dismounting with Screwdriver

Press the mounting hooks of the Photomicrosensor with a flat-blade screwdriver as shown in the following illustration and pull up the Photomicrosensor.

