



Chipsmall Limited consists of a professional team with an average of over 10 year of expertise in the distribution of electronic components. Based in Hongkong, we have already established firm and mutual-benefit business relationships with customers from,Europe,America and south Asia,supplying obsolete and hard-to-find components to meet their specific needs.

With the principle of “Quality Parts,Customers Priority,Honest Operation,and Considerate Service”,our business mainly focus on the distribution of electronic components. Line cards we deal with include Microchip,ALPS,ROHM,Xilinx,Pulse,ON,Everlight and Freescale. Main products comprise IC,Modules,Potentiometer,IC Socket,Relay,Connector.Our parts cover such applications as commercial,industrial, and automotives areas.

We are looking forward to setting up business relationship with you and hope to provide you with the best service and solution. Let us make a better world for our industry!



Contact us

Tel: +86-755-8981 8866 Fax: +86-755-8427 6832

Email & Skype: info@chipsmall.com Web: www.chipsmall.com

Address: A1208, Overseas Decoration Building, #122 Zhenhua RD., Futian, Shenzhen, China



Ultra-compact Pre-wired Photomicrosensor (Non-modulated) EE-SX95

Meeting Customer Needs with Ultra-compact Sensors that Mount with M3 Screws

- Mount using M3 or M2 screws.
- Reliable sensing slot depth of 6.5 mm.
- Indication of sensing window for easy confirmation of insertion depth.
- Bright indicator for confirmation from many directions.
- Both light-ON and dark-ON outputs provided.
- All models available with either standard cable or flexible robot cable.
- Load short-circuit protection circuit provided.



 Refer to the *Safety Precautions* on page 5.

For the most recent information on models that have been certified for safety standards, refer to your OMRON website.

Features

Mount Using M2 or M3 Screws

The EE-SX95 can be mounted using M2 or M3 screws, so it can easily replace an existing Sensor mounted with M2 screws.

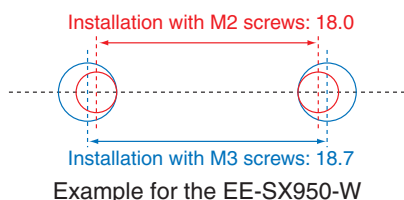

Reliable Best-in-Class Sensing Slot Depth of 6.5 mm

(Based on April 2013 OMRON investigation.)

A deeper slot helps prevent the sensing object from coming into contact with the base of the slot, creating greater tolerance in mechanism design.

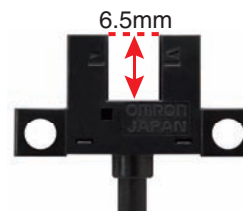

Indication of Sensing Window for Easy Confirmation of Insertion Depth

The location of the sensing window is indicated on the insertion slot so that you can visually confirm whether the sensing object covers the sensing window and easily check the insertion depth.

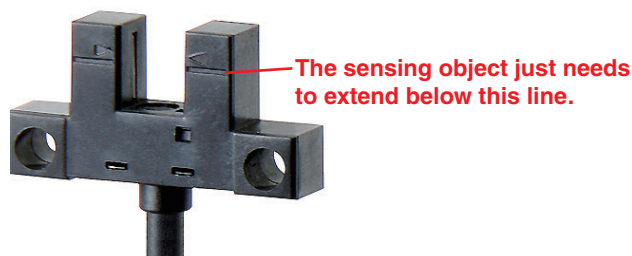

Bright Indicator for Confirmation from Many Directions

The bright light indicator can be checked from up to four directions to enable flexible selection of the installation location.

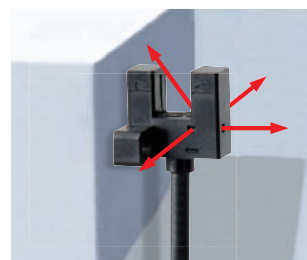



EE-SX95

Ordering Information

Sensors

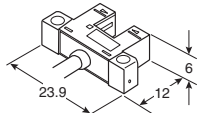
 Infrared light

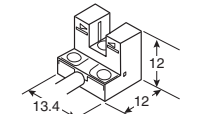
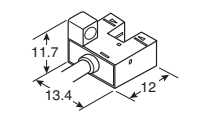
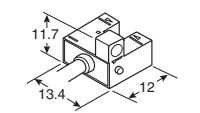
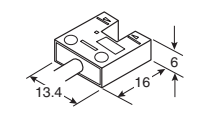
Appearance	Sensing method	Sensing distance	Output configuration	Connection method (Cable length)	Output type	Model
Standard 	Through-beam (with slot)	 5 mm (slot width)	Light-ON Dark-ON (2 outputs)	Pre-wired model with standard cable (1 m)	NPN	EE-SX950-W 1M *1
					PNP	EE-SX950P-W 1M *2
				Pre-wired model with robot cable (1 m)	NPN	EE-SX950-R 1M *1
				Pre-wired connector model with robot cable (0.3 m)	NPN	EE-SX950-C1J-R 0.3M
L-shaped 				Pre-wired model with standard cable (1 m)	NPN	EE-SX951-W 1M *1
					PNP	EE-SX951P-W 1M *2
				Pre-wired model with robot cable (1 m)	NPN	EE-SX951-R 1M *1
				Pre-wired connector model with robot cable (0.3 m)	NPN	EE-SX951-C1J-R 0.3M
F-shaped 				Pre-wired model with standard cable (1 m)	NPN	EE-SX952-W 1M *1
					PNP	EE-SX952P-W 1M *2
				Pre-wired model with robot cable (1 m)	NPN	EE-SX952-R 1M *1
				Pre-wired connector model with robot cable (0.3 m)	NPN	EE-SX952-C1J-R 0.3M
R-shaped 				Pre-wired model with standard cable (1 m)	NPN	EE-SX953-W 1M *1
					PNP	EE-SX953P-W 1M *2
				Pre-wired model with robot cable (1 m)	NPN	EE-SX953-R 1M *1
				Pre-wired connector model with robot cable (0.3 m)	NPN	EE-SX953-C1J-R 0.3M
U-shaped 	Pre-wired model with standard cable (1 m)	NPN	EE-SX954-W 1M *1			
		PNP	EE-SX954P-W 1M *2			
	Pre-wired model with robot cable (1 m)	NPN	EE-SX954-R 1M *1			
	Pre-wired connector model with robot cable (0.3 m)	NPN	EE-SX954-C1J-R 0.3M			

*1. A model is available with a 3-m cable. The model number is EE-SX95□-□ 3M.(Example: EE-SX950-W 3M)

*2. A pre-wired model with a PNP output and 1-m robot cable is available. The model number is EE-SX95□P-R 1M.(Example: EE-SX950P-R 1M)

Accessories (Order Separately)

Connector with Robot Cable

Type	Cable length	Model	Remarks
Connector with Cable	2 m	EE-1016-R 2M	Connector with lock, AWG26, 4-core Robot Cable

Ratings and Specifications

Item	Type		Standard	L-shaped	F-shaped	R-shaped	U-shaped
	NPN output	Pre-wired models	EE-SX950-□	EE-SX951-□	EE-SX952-□	EE-SX953-□	EE-SX954-□
		Pre-wired connector models	EE-SX950-C1J-R	EE-SX951-C1J-R	EE-SX952-C1J-R	EE-SX953-C1J-R	EE-SX954-C1J-R
PNP output	Pre-wired models		EE-SX950P-□	EE-SX951P-□	EE-SX952P-□	EE-SX953P-□	EE-SX954P-□
Sensing distance			5 mm (slot width)				
Standard sensing object			Opaque: 1.8 × 0.8 mm min.				
Differential travel			0.025 mm max. *1				
Light source (wave length)			Infrared LED (940 nm)				
Indicator			Light indicator (red LED)				
Power supply voltage			5 to 24 VDC ±10%, ripple (p-p): 10% max.				
Current consumption			15 mA max.				
Control output			Load power supply voltage: 5 to 24 VDC Load current: 50 mA max. OFF current: 0.5 mA max. 50 mA load current with a residual voltage of 0.7 V max. 5 mA load current with a residual voltage of 0.4 V max.				
Protection circuit			Load short-circuit protection				
Response frequency			1 kHz min. (3 kHz average) *2				
Ambient illumination			1,000 lx max. with fluorescent light on the surface of the receiver				
Ambient temperature range			Operating: -25 to 55°C Storage: -30 to 80°C (with no icing or condensation)				
Ambient humidity range			Operating: 5% to 85% Storage: 5% to 95% (with no icing or condensation)				
Vibration resistance (destruction)			10 to 2,000 Hz (peak acceleration: 150m/s ²) with a 0.75-mm single amplitude for 2.5 h (15-min periods, 10 cycles) each in X, Y, and Z directions				
Shock resistance (destruction)			500 m/s ² for 3 times each in X, Y, and Z directions				
Degree of protection			IEC60529 IP50				
Connection method			Pre-wired models (standard length: 1 m), Pre-wired connector models (standard length: 0.3 m)				
Weight (packed state)	Pre-wired models		Approx. 15 g				
	Pre-wired connector models		Approx. 7 g				
Materials	Case/cover		Polybutylene terephthalate (PBT)				
	Emitter/receiver		Polycarbonate (PC)				

*1. The differential travel is the value when a sensing object is moved in a lateral direction to the slot.

*2. The response frequency was measured by detecting the following rotating disk.

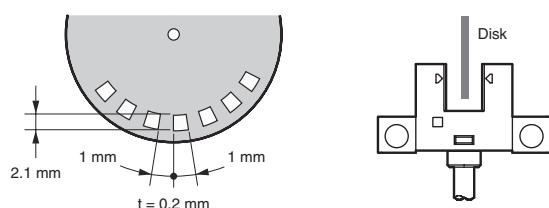

Applicable Connector

Item	Product Model	Connector with Robot Cable
	Appearance	EE-1016-R
Contact resistance	25 mΩ max. (at 10 mA DC and 20 mV max.)	
Insertion strength	20 N max.	
Surplus strength (housing holding strength)	15 N min.	
Cable length	2 m	
Ambient temperature range	-25 to 85°C	
Materials	Housing	Nylon
	Contact	Phosphor bronze

EE-SX95

Engineering Data (Reference Value)

Sensing Position Characteristics

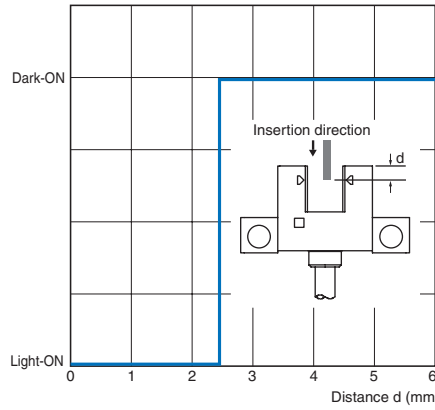
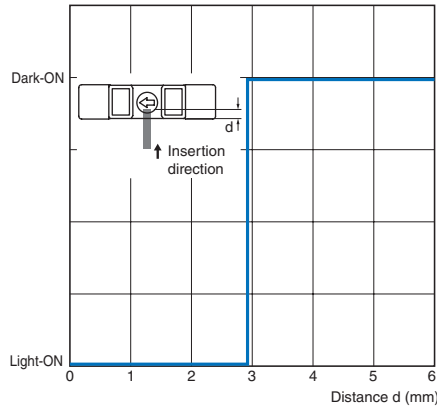

Repeated Sensing Position Characteristics

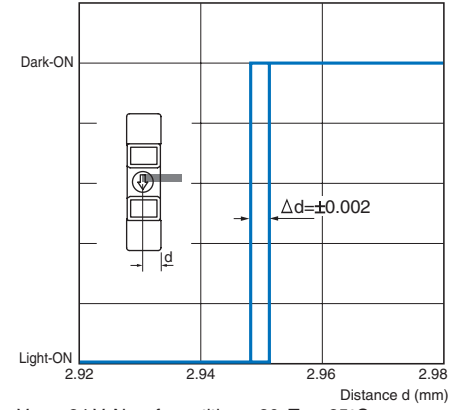

Vcc = 24 V, No. of repetitions: 20, Ta = 25°C
(Differential travel = 0.025 mm max.)

Note: The data applies to dark status. Operation may be affected by external light interference or light coming through the sensing object.

I/O Circuit Diagrams

Output type	Model	Output transistor operation status	Timing charts	Output circuit
NPN output	EE-SX950-□ EE-SX951-□ EE-SX952-□ EE-SX953-□ EE-SX954-□ EE-SX950-C1J-R EE-SX951-C1J-R EE-SX952-C1J-R EE-SX953-C1J-R EE-SX954-C1J-R	OUT1: Light-ON OUT2: Dark-ON	<p>Incident light</p> <p>No incident light</p> <p>Light indicator ON (red)</p> <p>Output 1 ON</p> <p>transistor OFF</p> <p>Load 1 Operate (e.g., relay) Reset</p> <p>Output 2 ON</p> <p>transistor OFF</p> <p>Load 2 Operate (e.g., relay) Reset</p>	<p>Connector pin arrangement for models with connectors</p>
	PNP output			EE-SX950P-□ EE-SX951P-□ EE-SX952P-□ EE-SX953P-□ EE-SX954P-□

Safety Precautions

Refer to *Warranty and Limitations of Liability*.

⚠ WARNING

This product is not designed or rated for ensuring safety of persons either directly or indirectly. Do not use it for such purposes.



Precautions for Safe Use

Power Supply Voltage

Do not exceed the voltage range indicated in the specifications. Applying a voltage exceeding the specifications or using an AC power supply may result in rupture or burning.

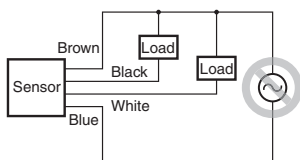

Faulty Wiring

Do not reverse the power supply polarity. Doing so may result in rupture or burning.

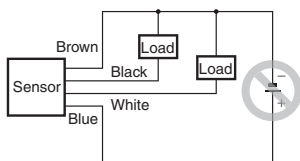

Load Short-circuit

Do not short-circuit the load. (Do not connect to the power supply.) Doing so may result in rupture or burning.

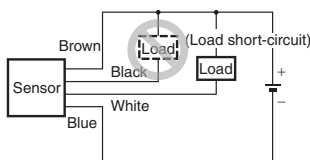

Precautions for Correct Use

Do not use the product in atmospheres or environments that exceed product ratings.

● Operating Environment

- Do not install the Sensor in the following places to prevent malfunction or trouble:
 - Places exposed to dust or oil mist
 - Places exposed to corrosive gas
 - Places directly or indirectly exposed to water, oil, or chemicals
 - Outdoor or places exposed to intensive light, such as direct sunlight
- Be sure to use the Sensor under the rated ambient temperature.
- The Sensor may be dissolved by exposure to organic solvents, acids, alkali, or aromatic hydrocarbons, aliphatic chloride hydrocarbons causing deterioration in characteristics. Do not expose the Sensor to such chemicals.

● Installation

- It is assumed that EE-SX95 Sensors will be built into a device. These Sensors use non-modulated light and are not equipped to deal with interference from an external light source. When they are used in locations subject to external light interference, such as near a window or under an incandescent light, install them to minimize the effects of external light interference.
- Mount the Sensors securely on a flat surface.
- Use M3 or M2.0 screws to secure the Photomicrosensor. (The stronger M3 screws are recommended. In addition, use flat washers and spring washers to prevent the screws from loosening.) Refer to the following table for the correct tightening torque.

Screw diameter	Tightening torque
M2.0	0.15 N·m max.
M3	0.54 N·m max.

- If the Sensor is to be used on a moving part, secure the cable connection point so that it is not directly subjected to stress.

● Wiring

Unused Output Lines

Be sure to isolate output lines that are not going to be used.

Connecting to Devices with Voltage Input

Specifications

A Sensor with an open-collector output can be connected to a counter with a voltage input by connecting a resistor between the power source and output. Select a resistor with reference to the following example. The resistance of the resistor is generally 4.7 kΩ and its wattage is 1/2 W for a supply voltage of 24 V and 1/4 W for 12 V.

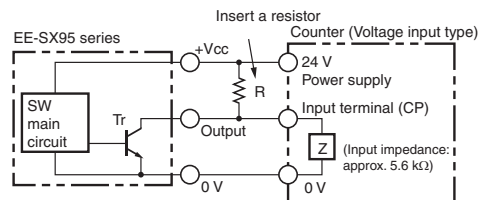

Example: EE-SX95 Series
Load Resistance of 4.7 kΩ Connected in a Counter

Counter Specifications

Input impedance	5.6 KΩ
Voltage judged as high level (input ON)	4.5 to 30 VDC
Voltage judged as low level (input OFF)	0 to 2 VDC

The high and low levels are found using the following formulas. The input device specifications must satisfy both formulas.

High level:

$$\text{Input voltage } V_H = \frac{Z}{R+Z} \times V_{CC} = \frac{5.6 \text{ k}}{4.7 \text{ k} + 5.6 \text{ k}} \times 24 \text{ V} = 13 \text{ V}$$

Low level:

$$\text{Load current } I_c = \frac{V_{CC}}{R} = \frac{24 \text{ V}}{R} = 5.1 \text{ mA} \leq 50 \text{ mA}$$

Input voltage $V_L \leq 1.0 \text{ V}$ (Residual voltage for 50-mA load current)

Note: Refer to the ratings of the Sensor for the residual voltage of the load current.

Load Short-circuit Protection

- The EE-SX95 provides load short-circuit protection. If a load short circuit occurs, the output will go OFF. Check the wiring and cycle the power supply. The load short-circuit protection circuit will be reset. The load short-circuit protection will also operate if the current exceeds the rated load current. If a capacitive load is being used, make sure that the inrush current will not exceed the rated load current.

Other Precautions

- Do not disconnect or wire the cables from the Sensor when power is supplied to the Sensor, or Sensor damage could result.
- Make sure the total length of the power cable connected to the product is less than 10 m.

● Other Precautions

- An output pulse may occur when the power supply is turned ON depending on the power supply and other conditions. The operation of the Sensor will be stable 100 ms after turning ON the power supply.
- Dispose of this product as industrial waste.

Dimensions

Tolerance class IT16 applies to dimensions in this datasheet unless otherwise specified.

Sensors

EE-SX950-□
EE-SX950P-□
EE-SX950-C1J-R

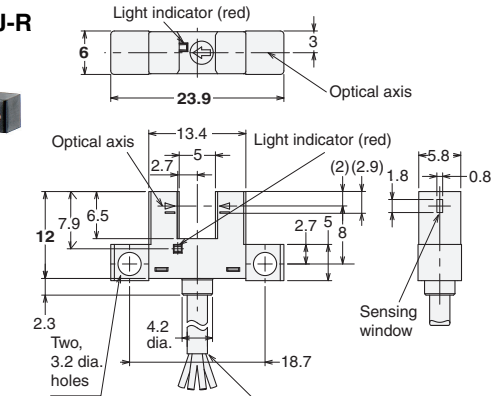
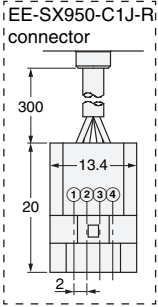

Terminal Arrangement

①	Vcc
②	OUT2
③	GND(0 V)
④	OUT1

-W: Round vinyl-insulated cable of 2.8 dia., 4 cores, (0.14 mm² with 0.90-mm dia. insulator); Standard length: 1 m
-R: Robot cable of 2.8 dia., 4 cores, (0.15 mm² with 0.92-mm dia. insulator); Standard length: 1 m

EE-SX951-□
EE-SX951P-□
EE-SX951-C1J-R

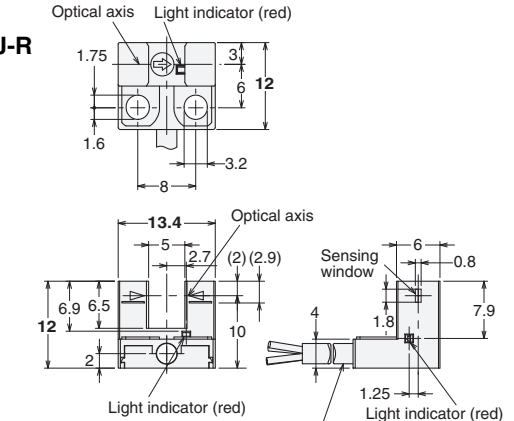
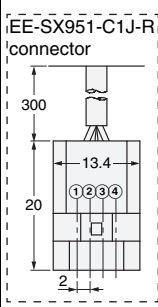

Terminal Arrangement

①	Vcc
②	OUT2
③	GND(0 V)
④	OUT1

-W: Round vinyl-insulated cable of 2.8 dia., 4 cores, (0.14 mm² with 0.90-mm dia. insulator); Standard length: 1 m
-R: Robot cable of 2.8 dia., 4 cores, (0.15 mm² with 0.92-mm dia. insulator); Standard length: 1 m

EE-SX952-□
EE-SX952P-□
EE-SX952-C1J-R

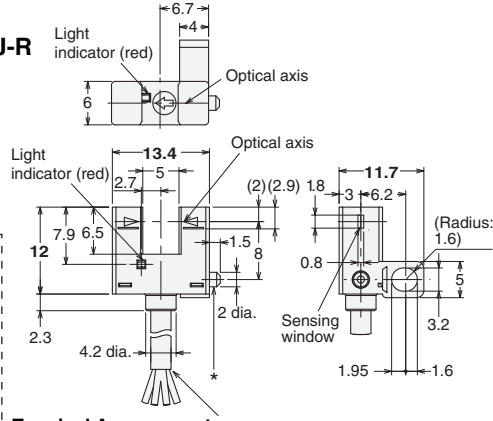
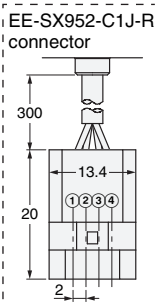

Terminal Arrangement

①	Vcc
②	OUT2
③	GND(0 V)
④	OUT1

-W: Round vinyl-insulated cable of 2.8 dia., 4 cores, (0.14 mm² with 0.90-mm dia. insulator); Standard length: 1 m
-R: Robot cable of 2.8 dia., 4 cores, (0.15 mm² with 0.92-mm dia. insulator); Standard length: 1 m

* The lug is used to prevent turning. When installing, make a fixed hole of 2.1 to 2.3 mm dia.

EE-SX953-□
EE-SX953P-□
EE-SX953-C1J-R

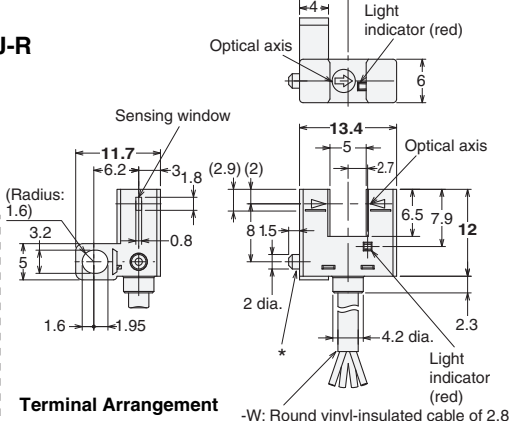
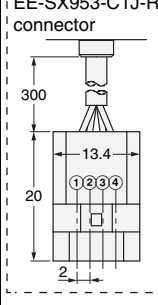

Terminal Arrangement

①	Vcc
②	OUT2
③	GND(0 V)
④	OUT1

-W: Round vinyl-insulated cable of 2.8 dia., 4 cores, (0.14 mm² with 0.90-mm dia. insulator); Standard length: 1 m
-R: Robot cable of 2.8 dia., 4 cores, (0.15 mm² with 0.92-mm dia. insulator); Standard length: 1 m

* The lug is used to prevent turning. When installing, make a fixed hole of 2.1 to 2.3 mm dia.

EE-SX954-□
EE-SX954P-□
EE-SX954-C1J-R

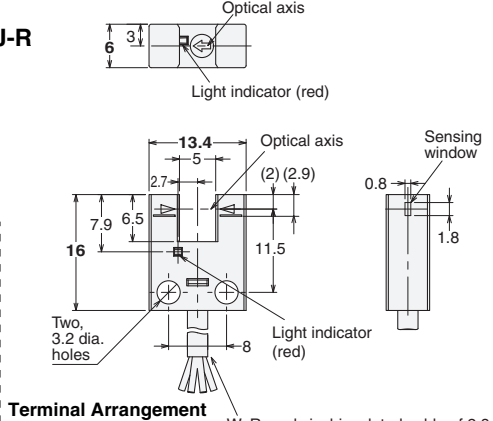
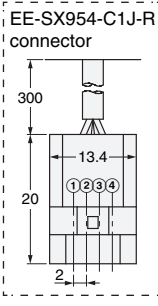

Terminal Arrangement

①	Vcc
②	OUT2
③	GND(0 V)
④	OUT1

-W: Round vinyl-insulated cable of 2.8 dia., 4 cores, (0.14 mm² with 0.90-mm dia. insulator); Standard length: 1 m
-R: Robot cable of 2.8 dia., 4 cores, (0.15 mm² with 0.92-mm dia. insulator); Standard length: 1 m

Accessories (Order Separately)

Connector with Robot Cable

EE-1016-R

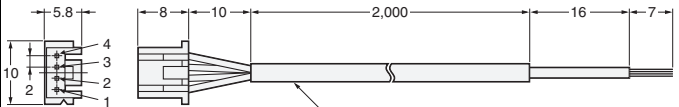

Terminal Arrangement

①	+	Brown
②	OUTPUT 2	White
③	-	Blue
④	OUTPUT 1	Black

Robot cable of 2.8 dia., 4 cores, (0.15 mm² with 0.8-mm dia. insulator); Standard length: 2 m

Note: The Connector fits into a connector of the Sensor, so there is no protrusion from the surface of the connector of the Sensor.

Terms and Conditions Agreement

Read and understand this catalog.

Please read and understand this catalog before purchasing the products. Please consult your OMRON representative if you have any questions or comments.

Warranties.

(a) Exclusive Warranty. Omron's exclusive warranty is that the Products will be free from defects in materials and workmanship for a period of twelve months from the date of sale by Omron (or such other period expressed in writing by Omron). Omron disclaims all other warranties, express or implied.

(b) Limitations. OMRON MAKES NO WARRANTY OR REPRESENTATION, EXPRESS OR IMPLIED, ABOUT NON-INFRINGEMENT, MERCHANTABILITY OR FITNESS FOR A PARTICULAR PURPOSE OF THE PRODUCTS. BUYER ACKNOWLEDGES THAT IT ALONE HAS DETERMINED THAT THE PRODUCTS WILL SUITABLY MEET THE REQUIREMENTS OF THEIR INTENDED USE.

Omron further disclaims all warranties and responsibility of any type for claims or expenses based on infringement by the Products or otherwise of any intellectual property right. (c) Buyer Remedy. Omron's sole obligation hereunder shall be, at Omron's election, to (i) replace (in the form originally shipped with Buyer responsible for labor charges for removal or replacement thereof) the non-complying Product, (ii) repair the non-complying Product, or (iii) repay or credit Buyer an amount equal to the purchase price of the non-complying Product; provided that in no event shall Omron be responsible for warranty, repair, indemnity or any other claims or expenses regarding the Products unless Omron's analysis confirms that the Products were properly handled, stored, installed and maintained and not subject to contamination, abuse, misuse or inappropriate modification. Return of any Products by Buyer must be approved in writing by Omron before shipment. Omron Companies shall not be liable for the suitability or unsuitability or the results from the use of Products in combination with any electrical or electronic components, circuits, system assemblies or any other materials or substances or environments. Any advice, recommendations or information given orally or in writing, are not to be construed as an amendment or addition to the above warranty.

See <http://www.omron.com/global/> or contact your Omron representative for published information.

Limitation on Liability; Etc.

OMRON COMPANIES SHALL NOT BE LIABLE FOR SPECIAL, INDIRECT, INCIDENTAL, OR CONSEQUENTIAL DAMAGES, LOSS OF PROFITS OR PRODUCTION OR COMMERCIAL LOSS IN ANY WAY CONNECTED WITH THE PRODUCTS, WHETHER SUCH CLAIM IS BASED IN CONTRACT, WARRANTY, NEGLIGENCE OR STRICT LIABILITY.

Further, in no event shall liability of Omron Companies exceed the individual price of the Product on which liability is asserted.

Suitability of Use.

Omron Companies shall not be responsible for conformity with any standards, codes or regulations which apply to the combination of the Product in the Buyer's application or use of the Product. At Buyer's request, Omron will provide applicable third party certification documents identifying ratings and limitations of use which apply to the Product. This information by itself is not sufficient for a complete determination of the suitability of the Product in combination with the end product, machine, system, or other application or use. Buyer shall be solely responsible for determining appropriateness of the particular Product with respect to Buyer's application, product or system. Buyer shall take application responsibility in all cases.

NEVER USE THE PRODUCT FOR AN APPLICATION INVOLVING SERIOUS RISK TO LIFE OR PROPERTY OR IN LARGE QUANTITIES WITHOUT ENSURING THAT THE SYSTEM AS A WHOLE HAS BEEN DESIGNED TO ADDRESS THE RISKS, AND THAT THE OMRON PRODUCT(S) IS PROPERLY RATED AND INSTALLED FOR THE INTENDED USE WITHIN THE OVERALL EQUIPMENT OR SYSTEM.

Programmable Products.

Omron Companies shall not be responsible for the user's programming of a programmable Product, or any consequence thereof.

Performance Data.

Data presented in Omron Company websites, catalogs and other materials is provided as a guide for the user in determining suitability and does not constitute a warranty. It may represent the result of Omron's test conditions, and the user must correlate it to actual application requirements. Actual performance is subject to the Omron's Warranty and Limitations of Liability.

Change in Specifications.

Product specifications and accessories may be changed at any time based on improvements and other reasons. It is our practice to change part numbers when published ratings or features are changed, or when significant construction changes are made. However, some specifications of the Product may be changed without any notice. When in doubt, special part numbers may be assigned to fix or establish key specifications for your application. Please consult with your Omron's representative at any time to confirm actual specifications of purchased Product.

Errors and Omissions.

Information presented by Omron Companies has been checked and is believed to be accurate; however, no responsibility is assumed for clerical, typographical or proofreading errors or omissions.

OMRON Corporation Industrial Automation Company
Tokyo, JAPAN

Contact: www.ia.omron.com

Regional Headquarters

OMRON EUROPE B.V.

Sensor Business Unit

Carl-Benz-Str. 4, D-71154 Nufringen, Germany
Tel: (49) 7032-811-0/Fax: (49) 7032-811-199

OMRON ELECTRONICS LLC

2895 Greenspoint Parkway, Suite 200
Hoffman Estates, IL 60169 U.S.A
Tel: (1) 847-843-7900/Fax: (1) 847-843-7787

OMRON ASIA PACIFIC PTE. LTD.

No. 438A Alexandra Road # 05-05/08 (Lobby 2),
Alexandra Technopark,
Singapore 119967
Tel: (65) 6835-3011/Fax: (65) 6835-2711

OMRON (CHINA) CO., LTD.

Room 2211, Bank of China Tower,
200 Yin Cheng Zhong Road,
PuDong New Area, Shanghai, 200120, China
Tel: (86) 21-5037-2222/Fax: (86) 21-5037-2200

Authorized Distributor:

© OMRON Corporation 2013-2015 All Rights Reserved.
In the interest of product improvement,
specifications are subject to change without notice.

CSM_3_4_1115
Cat. No. E435-E1-02

Printed in Japan
0215 (0513)