



Chipsmall Limited consists of a professional team with an average of over 10 year of expertise in the distribution of electronic components. Based in Hongkong, we have already established firm and mutual-benefit business relationships with customers from,Europe,America and south Asia,supplying obsolete and hard-to-find components to meet their specific needs.

With the principle of "Quality Parts,Customers Priority,Honest Operation,and Considerate Service",our business mainly focus on the distribution of electronic components. Line cards we deal with include Microchip,ALPS,ROHM,Xilinx,Pulse,ON,Everlight and Freescale. Main products comprise IC,Modules,Potentiometer,IC Socket,Relay,Connector.Our parts cover such applications as commercial,industrial, and automotives areas.

We are looking forward to setting up business relationship with you and hope to provide you with the best service and solution. Let us make a better world for our industry!



Contact us

Tel: +86-755-8981 8866 Fax: +86-755-8427 6832

Email & Skype: info@chipsmall.com Web: www.chipsmall.com

Address: A1208, Overseas Decoration Building, #122 Zhenhua RD., Futian, Shenzhen, China



**UltraCMOS® SP5T RF Switch
30–1000 MHz**

Product Description

The PE42850 is a HaRP™ technology-enhanced SP5T high power RF switch supporting wireless applications up to 1 GHz. It offers maximum power handling of 42.5 dBm continuous wave (CW). It delivers high linearity and excellent harmonics performance. It has both a standard and attenuated RX mode. No blocking capacitors are required if DC voltage is not present on the RF ports.

The PE42850 is manufactured on Peregrine’s UltraCMOS® process, a patented variation of silicon-on-insulator (SOI) technology on a sapphire substrate, offering the performance of GaAs with the economy and integration of conventional CMOS.

Figure 1. Package Type

32-lead 5 × 5 mm QFN

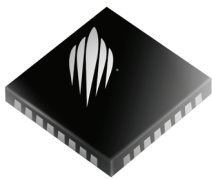
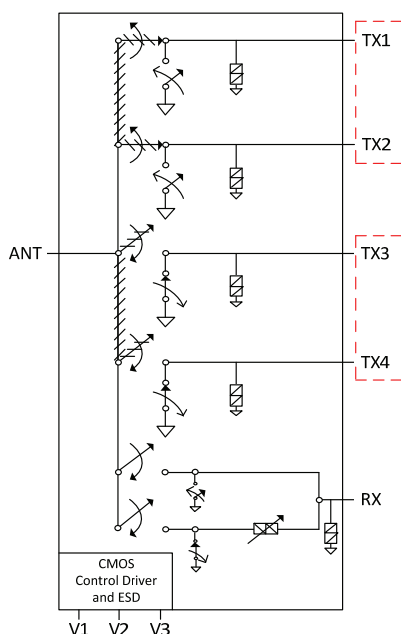
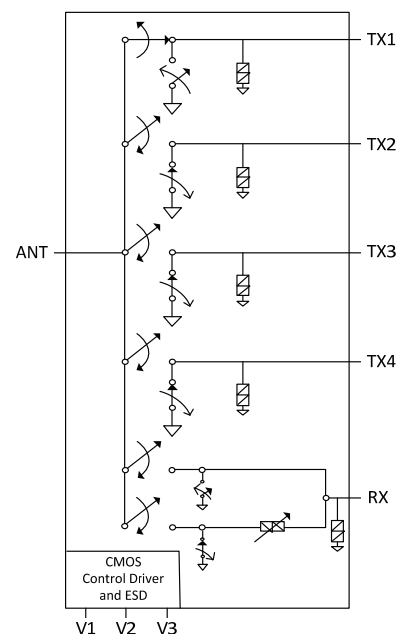

Figure 2. Functional Diagram of SP3T Configuration



ANT can be tied to TX1 and TX2 or TX3 and TX4

Figure 3. Functional Diagram of SP5T Configuration



SP5T, standard configuration

DOC-02178

Table 1. Electrical Specifications @ -40 to +85 °C, $V_{DD} = 2.3-5.5V$, $V_{SS_EXT} = 0V$ or $V_{DD} = 3.4-5.5V$, $V_{SS_EXT} = -3.4V$ ($Z_S = Z_L = 50\Omega$), unless otherwise noted¹

| Parameter | Path | Condition | Min | Typ | Max | Unit | |
|--|--------|--|----------|--------------|--------------|----------|-----|
| Operating frequency | | | 30 | | 1000 | MHz | |
| Insertion loss ² | ANT-TX | Active TX port 1, 2, 3 or 4 @ rated power (-40 °C, +25 °C) 30-520 MHz 520-1000 MHz | | 0.25 0.35 | 0.30 0.45 | dB dB | |
| | | Active TX port 1, 2, 3 or 4 @ rated power (+85 °C) 30-520 MHz 520-1000 MHz | | 0.30 0.45 | 0.35 0.55 | dB dB | |
| Insertion loss ² (un-attenuated state) | ANT-RX | Active RX port (-40 °C, +25 °C) 30-520 MHz 520-1000 MHz | | 0.50 0.65 | 0.60 0.80 | dB dB | |
| | | Active RX port (+85 °C) 30-520 MHz 520-1000 MHz | | 0.60 0.70 | 0.70 0.85 | dB dB | |
| | | 1575 MHz for GPS RX, < -10 dBm, +25 °C | | 1 | 1.2 | dB | |
| Insertion loss ² (attenuated state) | ANT-RX | Active RX port 30-1000 MHz | 15.2 | 16 | 16.8 | dB | |
| Isolation (supply biased) | TX-TX | 30-520 MHz 520-1000 MHz | 33 29 | 36 30 | | dB dB | |
| | | 30-520 MHz 520-1000 MHz | 34 29 | 36 30 | | dB dB | |
| Unbiased isolation $V_{DD}, V1, V2, V3 = 0V$ | ANT-TX | +27 dBm | 6 | | | dB | |
| Unbiased isolation $V_{DD}, V1, V2, V3 = 0V$ | ANT-RX | +27 dBm | 14 | | | dB | |
| Return loss ² | ANT-RX | Un-attenuated state 30-520 MHz 520-1000 MHz | 22 18 | 27 22 | | dB dB | |
| | | Un-attenuated state, 1575 MHz for GPS RX, < -10 dBm, +25 °C | 10 | 14 | | dB | |
| | | Attenuated state, optimized without attenuator engaged 30-520 MHz 520-1000 MHz | 16 13 | 21 18 | | dB dB | |
| Return loss ² | ANT-TX | 30-520 MHz 520-1000 MHz | 21 15 | 28 17 | | dB dB | |
| | | 2nd and 3rd harmonic (< 1.15:1 VSWR) | | | -90 | -81 | dBc |
| 2nd and 3rd harmonic (< 8:1 VSWR) | TX | 30-520 MHz @ +40.0 dBm 521-870 MHz @ +38.5 dBm 871-1000 MHz @ +37.5 dBm | | | -82 | -74 | dBc |
| 2nd and 3rd harmonic (50Ω source/load impedance) | TX | 30-1000 MHz @ +45.0 dBm (pulsed signal, at 10% duty cycle ³) | | | -80 | -71 | dBc |
| 2nd and 3rd harmonic (50Ω source/load impedance) | TX | 30-1000 MHz @ +42.5 dBm (CW) | | | -84 | -75 | dBc |
| Input 0.1dB compression point ⁴ | ANT-TX | 1000 MHz | | 45.5 | | dBm | |
| IIP3 | RX | Un-attenuated state | 42 | | | dBm | |
| | | Attenuated state | 33 | | | dBm | |
| Settling time | | From 50% control until harmonics within specifications | | 30 | 70 | μs | |
| Switching time | | 50% CTRL to 90% or 10% RF | | 15 | | μs | |

Notes: 1. In a 2TX-1RX SP3T configuration, TX1 and TX2 are tied and TX3 and TX4 are tied respectively. Refer to Application Note AN35 for SP3T performance data.
2. Narrow trace widths are used near each port to improve impedance matching. Refer to evaluation board layouts (Figure 23) and schematic (Figure 24) for details.
3. 10% of 4620 μs period.
4. The input 0.1dB compression point is a linearity figure of merit. Refer to Table 3 for the RF input power P_{IN} .

Figure 4. Pin Configuration (Top View)*

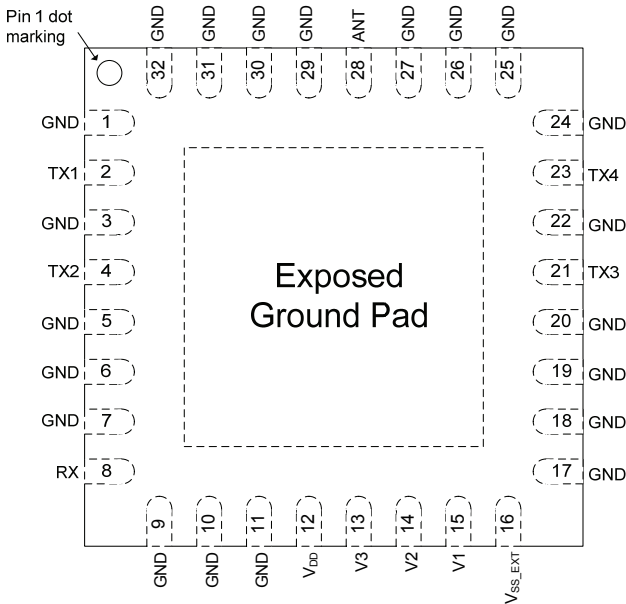

Note: * Pins 1, 3, 5, 7, 9, 10, 17, 19, 20, 22, 24, 26, 27, 29, 30 and 31 can be N/C if deemed necessary by the customer.

Table 2. Pin Descriptions

| Pin # | Pin Name | Description |
|--|----------------------------------|---|
| 1, 3, 5–7, 9–11, 17–20, 22, 24–27, 29–32 | GND | Ground |
| 2 | TX1 ² | Transmit pin 1 |
| 4 | TX2 ^{1,2} | Transmit pin 2 |
| 8 | RX ² | Receive pin |
| 12 | V _{DD} | Supply voltage (nominal 3.3V) |
| 13 | V3 | Digital control logic input 3 |
| 14 | V2 | Digital control logic input 2 |
| 15 | V1 | Digital control logic input 1 |
| 16 | V _{SS_EXT} ³ | External V _{SS} negative voltage control |
| 21 | TX3 ² | Transmit pin 3 |
| 23 | TX4 ^{1,2} | Transmit pin 4 |
| 28 | ANT ² | Antenna pin |
| Pad | GND | Exposed pad: ground for proper operation |

Notes: 1. To operate the part as a 2TX–1RX SP3T, tie TX1 to TX2 and TX3 to TX4 respectively. Refer to Application Note AN35 for SP3T performance data.
2. RF pins 2, 4, 8, 21, 23 and 28 must be at 0 VDC. The RF pins do not require DC blocking capacitors for proper operation if the 0 VDC requirement is met.
3. Use V_{SS_EXT} (pin 16, V_{SS_EXT} = –V_{DD}) to bypass and disable internal negative voltage generator. Connect V_{SS_EXT} (pin 16) to GND (V_{SS_EXT} = 0V) to enable internal negative voltage generator.

Table 3. Operating Ranges¹

| Parameter | Symbol | Min | Typ | Max | Unit |
|---|---------------------|------|-----|------|------|
| Supply voltage (normal mode, V _{SS_EXT} = 0V) | V _{DD} | 2.3 | | 5.5 | V |
| Supply voltage (bypass mode, V _{SS_EXT} = –3.4V, V _{DD} ≥ 3.4V for full spec. compliance) | V _{DD} | 2.7 | 3.4 | 5.5 | V |
| Negative supply voltage (bypass mode) | V _{SS_EXT} | –3.6 | | –3.2 | V |
| Supply current (normal mode, V _{SS_EXT} = 0V) | I _{DD} | | 130 | 200 | μA |
| Supply current (bypass mode, V _{SS_EXT} = –3.4V) | I _{DD} | | 50 | 80 | μA |
| Negative supply current (bypass mode, V _{SS_EXT} = –3.4V) | I _{SS} | –40 | –16 | | μA |
| Digital input high (V1, V2, V3) | V _{IH} | 1.17 | | 3.6 | V |
| Digital input low (V1, V2, V3) | V _{IL} | –0.3 | | 0.6 | V |
| TX RF input power ^{2,3} (VSWR ≤ 8:1) | P _{IN-TX} | | | 40 | dBm |
| TX RF input power ^{2,3} (50Ω source/load impedance) | P _{IN-TX} | | | 45 | dBm |
| TX RF input power ² (50Ω source/load impedance, CW) | P _{IN-TX} | | | 42.5 | dBm |
| ANT RF input power, unbiased (VSWR ≤ 8:1) | P _{IN-ANT} | | | 27 | dBm |
| RX RF input power ² (VSWR ≤ 8:1) | P _{IN-RX} | | | 27 | dBm |
| Operating temperature range (case) | T _{OP} | –40 | | 85 | °C |
| Operating junction temperature | T _j | | | 135 | °C |

Notes: 1. In a 2TX–1RX SP3T configuration, TX1 and TX2 are tied and TX3 and TX4 are tied respectively. Refer to Application Note AN35 for SP3T performance data.
2. Supply biased.
3. Pulsed, 10% duty cycle of 4620 μs period.

Table 4. Absolute Maximum Ratings

| Parameter/Condition | Symbol | Min | Max | Unit |
|--|---------------------|------|------|------|
| Supply voltage | V _{DD} | -0.3 | 5.5 | V |
| Digital input voltage (V1, V2, V3) | V _{CTRL} | -0.3 | 3.6 | V |
| TX RF input power ¹ (50Ω source/load impedance) | P _{IN-TX} | | 45 | dBm |
| TX RF input power ¹ (VSWR ≤ 8:1) | P _{IN-TX} | | 40 | dBm |
| ANT RF input power, unbiased (VSWR ≤ 8:1) | P _{IN-ANT} | | 27 | dBm |
| RX RF input power ¹ (VSWR ≤ 8:1) | P _{IN-RX} | | 27 | dBm |
| Storage temperature range | T _{ST} | -65 | 150 | °C |
| Maximum case temperature | T _{CASE} | | 85 | °C |
| Peak maximum junction temperature (10 seconds max) | T _j | | 200 | °C |
| ESD voltage HBM ² , all pins | V _{ESD} | | 1500 | V |
| ESD Voltage MM ³ , all pins | V _{ESD} | | 200 | V |

Notes: 1. Supply biased
2. Human Body Model (MIL-STD 883 Method 3015)
3. Machine Model (JEDEC JESD22-A115)

Exceeding absolute maximum ratings may cause permanent damage. Operation should be restricted to the limits in the Operating Ranges table. Operation between operating range maximum and absolute maximum for extended periods may reduce reliability.

Electrostatic Discharge (ESD) Precautions

When handling this UltraCMOS device, observe the same precautions that you would use with other ESD-sensitive devices. Although this device contains circuitry to protect it from damage due to ESD, precautions should be taken to avoid exceeding the rating specified.

Latch-Up Avoidance

Unlike conventional CMOS devices, UltraCMOS devices are immune to latch-up.

Moisture Sensitivity Level

The Moisture Sensitivity Level rating for the 5x5 mm QFN package is MSL3.

Switching Frequency

The PE42850 has a maximum 10 kHz switching rate when the internal negative voltage generator is used (pin 16 = GND). The rate at which the PE42850 can be switched is only limited to the switching time (*Table 1*) if an external negative supply is provided (pin 16 = V_{SS_EXT}).

Switching frequency describes the time duration between switching events. Switching time is the time duration between the point the control signal reaches 50% of the final value and the point the output signal reaches within 10% or 90% of its target value.

Optional External V_{SS} Control (V_{SS_EXT})

For proper operation, the V_{SS_EXT} control pin must be grounded or tied to the V_{SS} voltage specified in *Table 3*. When the V_{SS_EXT} control pin is grounded, FETs in the switch are biased with an internal voltage generator. For applications that require the lowest possible spur performance, V_{SS_EXT} can be applied externally to bypass the internal negative voltage generator.

Spurious Performance

The typical spurious performance of the PE42850 is -130 dBm when V_{SS_EXT} = 0V (pin 16 = GND). If further improvement is desired, the internal negative voltage generator can be disabled by setting V_{SS_EXT} = -3.4V.

Table 5. Truth Table

| Path | V3 | V2 | V1 |
|---------------------|----|----|----|
| ANT – RX Attenuated | L | L | L |
| ANT – TX1 | L | L | H |
| ANT – TX2 | L | H | L |
| ANT – TX1 and TX2* | L | H | H |
| ANT – RX | H | L | L |
| ANT – TX3 | H | L | H |
| ANT – TX4 | H | H | L |
| ANT – TX3 and TX4* | H | H | H |

Note: * In a 2TX-1RX SP3T configuration, TX1 and TX2 are tied and TX3 and TX4 are tied respectively. Refer to Application Note AN35 for SP3T performance data.

Typical Performance Data @ +25 °C and $V_{DD} = 3.4V$, unless otherwise specified

Figure 5. Insertion Loss vs. Temp (TX)

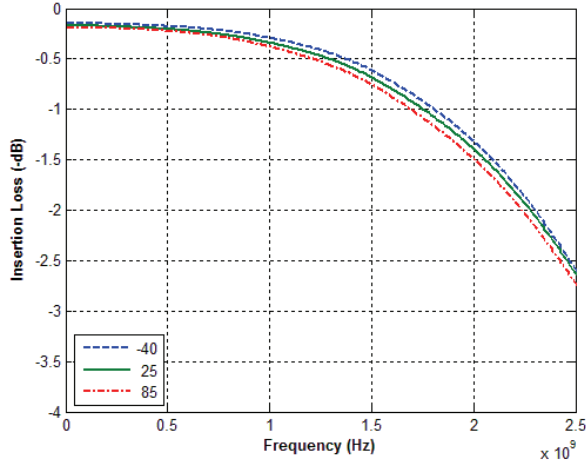

Figure 6. Insertion Loss vs. V_{DD} (TX)

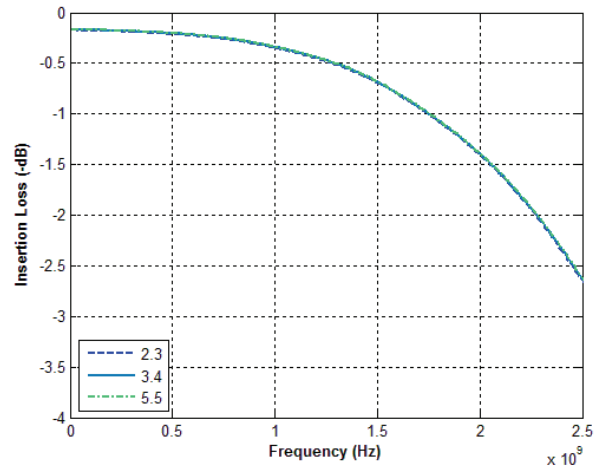

Figure 7. Insertion Loss vs. Temp (RX, Un-Attenuated)

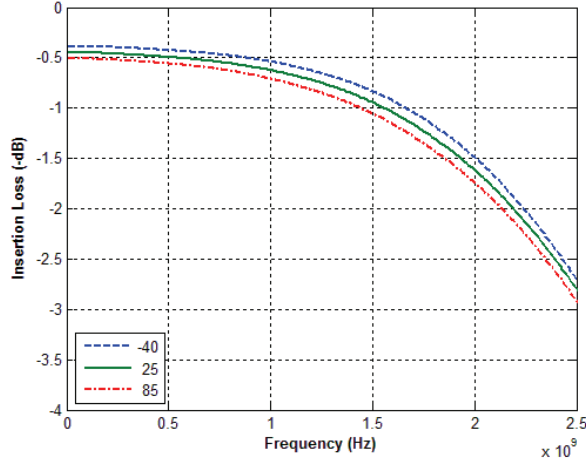

Figure 8. Insertion Loss vs. V_{DD} (RX, Un-Attenuated)

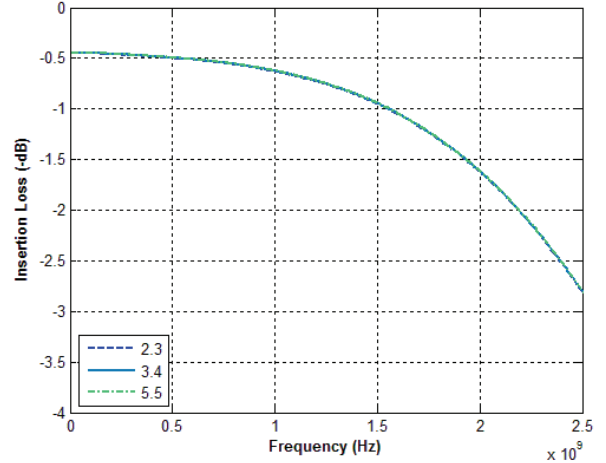

Figure 9. Insertion Loss vs. Temp (RX, Attenuated)

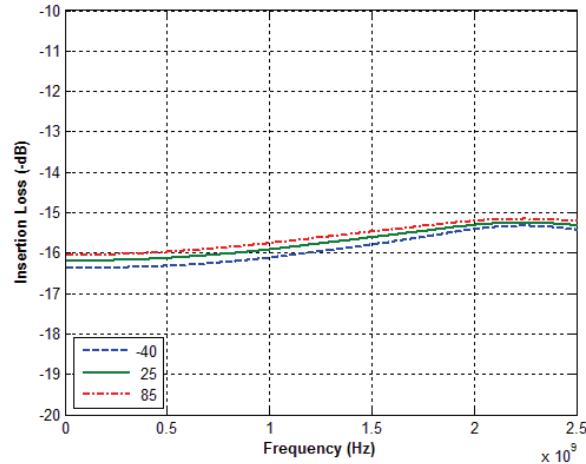
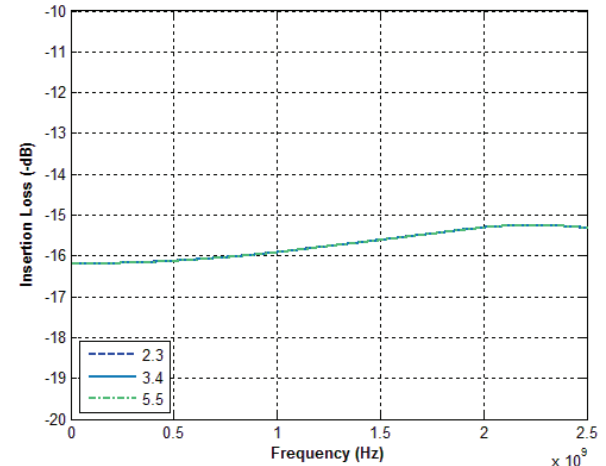

Figure 10. Insertion Loss vs. V_{DD} (RX, Attenuated)



Typical Performance Data @ +25 °C and $V_{DD} = 3.4V$, unless otherwise specified

Figure 11. Return Loss vs. Temp (ANT)

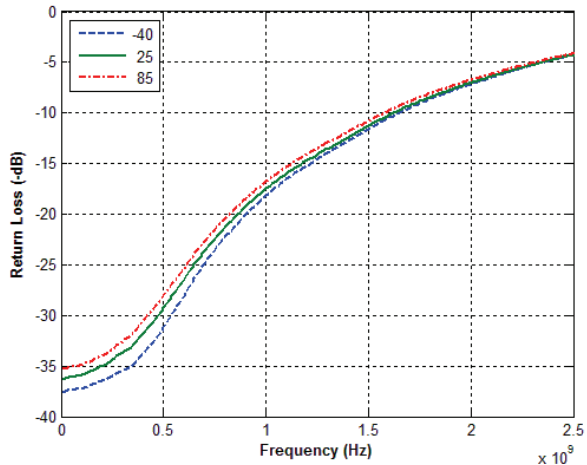

Figure 12. Return Loss vs. V_{DD} (ANT)

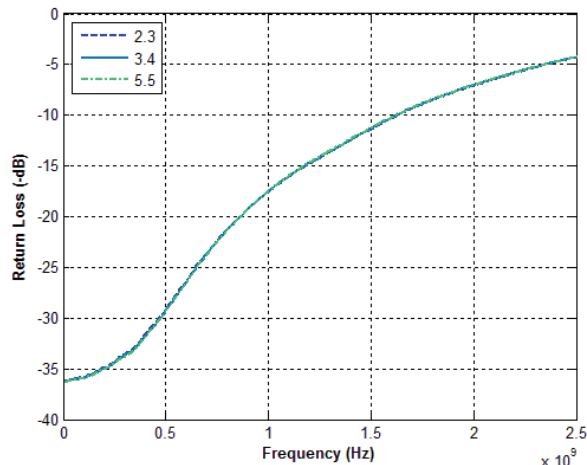

Figure 13. Return Loss vs. Temp (TX)

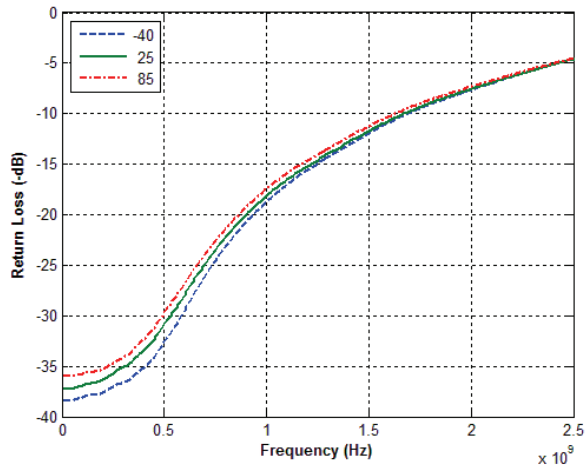

Figure 14. Return Loss vs. V_{DD} (TX)

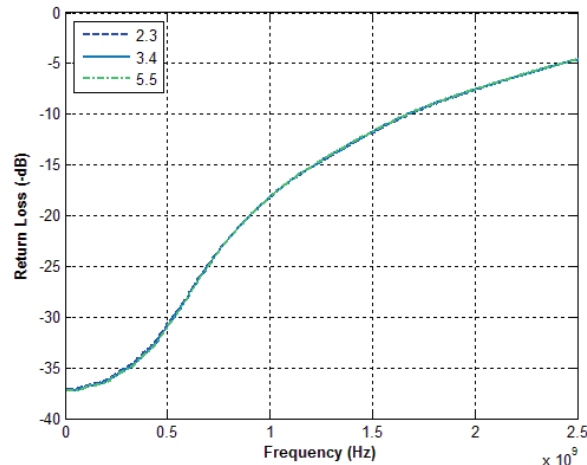

Figure 15. Return Loss vs. Temp (RX, Attenuated)

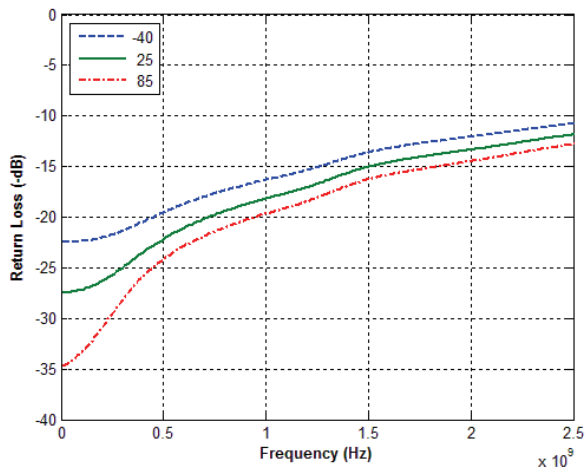
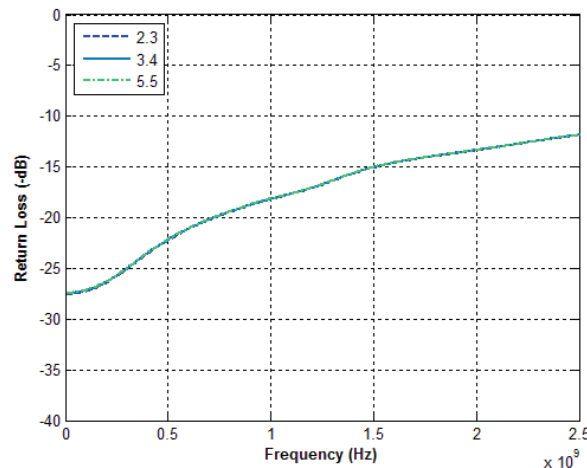

Figure 16. Return Loss vs. V_{DD} (RX, Attenuated)



Typical Performance Data @ +25 °C and $V_{DD} = 3.4V$, unless otherwise specified

Figure 17. Return Loss vs. Temp (RX, Un-Attenuated)

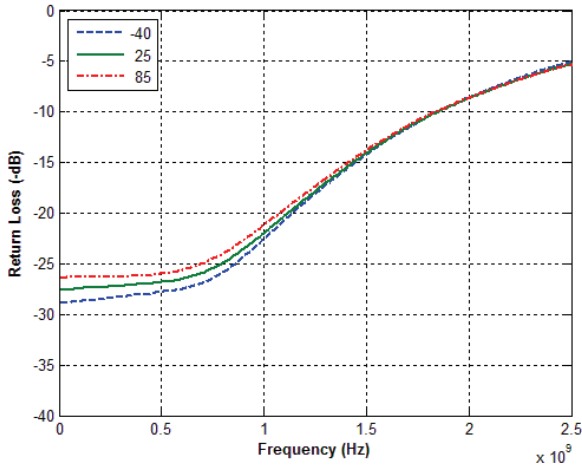

Figure 18. Return Loss vs. V_{DD} (RX, Un-Attenuated)

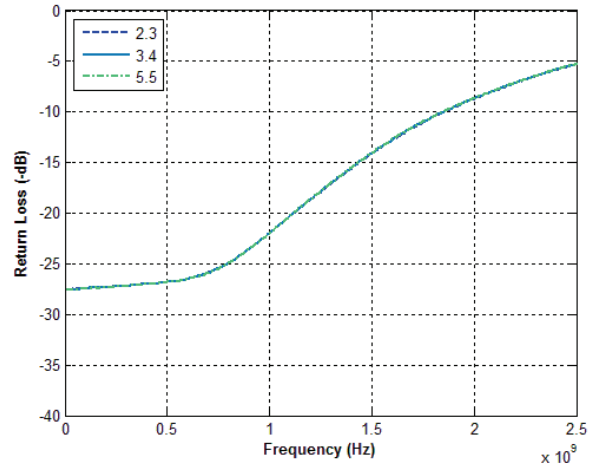

Figure 19. Isolation vs. Temp (TX-TX)

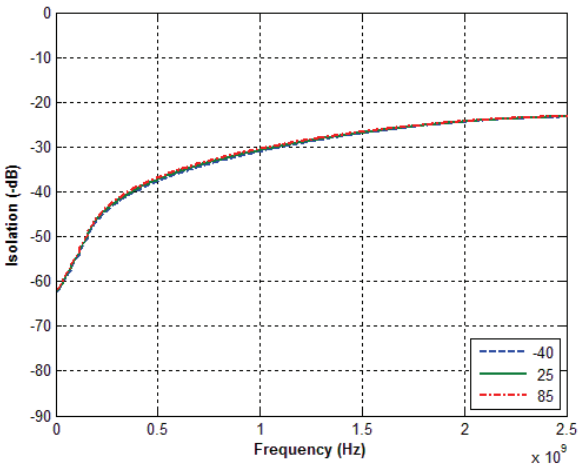

Figure 20. Isolation vs. V_{DD} (TX-TX)

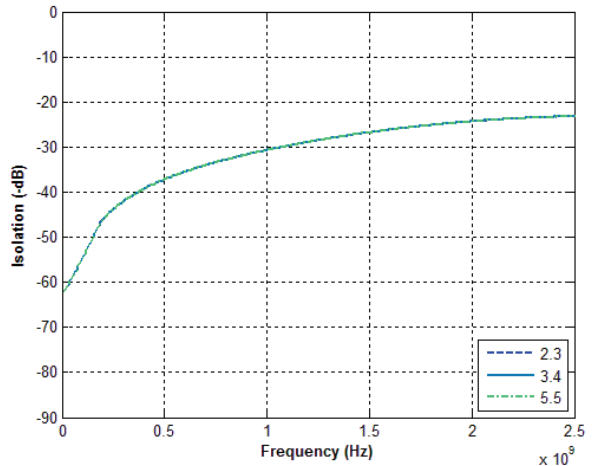

Figure 21. Isolation vs. Temp (TX-RX)

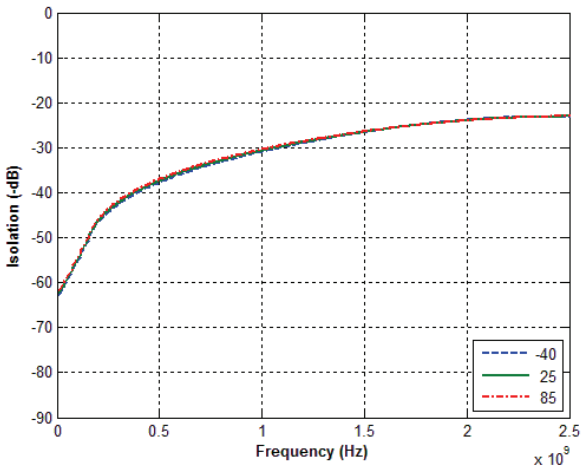
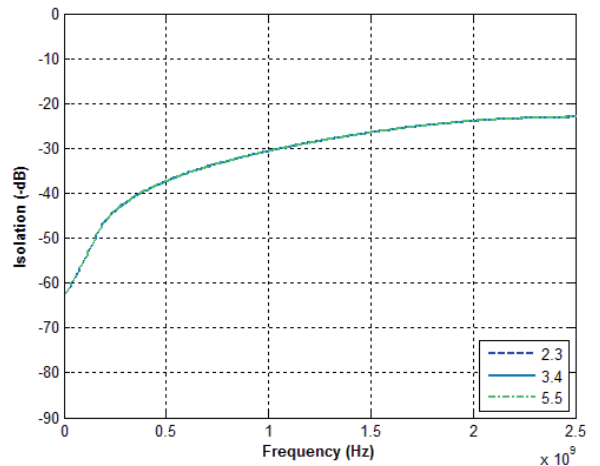

Figure 22. Isolation vs. V_{DD} (TX-RX)



Thermal Data

Though the insertion loss for this part is very low, when handling high power RF signals, the junction temperature rises significantly.

VSWR conditions that present short circuit loads to the part can cause significantly more power dissipation than with proper matching.

Special consideration needs to be made in the design of the PCB to properly dissipate the heat away from the part and maintain the +85 °C maximum case temperature. It is recommended to use best design practices for high power QFN packages: multi-layer PCBs with thermal vias in a thermal pad soldered to the slug of the package. Special care also needs to be made to alleviate solder voiding under the part.

Table 6. Theta JC

| Parameter | Min | Typ | Max | Unit |
|-------------------|-----|-----|-----|------|
| Theta JC (+85 °C) | | 20 | | °C/W |

Evaluation Kit

The PE42850 Evaluation Kit board was designed to ease customer evaluation of the PE42850 RF switch.

The evaluation board in Figure 23 was designed to test the part in the 5T configuration. DC power is supplied through J10, with V_{DD} on pin 9, and GND on the entire lower row of even numbered pins. To evaluate a switch path, add or remove jumpers on V1 (pin 3), V2 (pin 5), and V3 (pin 7) using *Table 5* (adding a jumper pulls the CMOS control pin low and removing it allows the on-board pull-up resistor to set the CMOS control pin high). Pins 11 and 13 of J10 are N/C.

The ANT port is connected through a 50Ω transmission line via the top SMA connector, J1. RX and TX paths are also connected through 50Ω transmission lines via SMA connectors. A 50Ω through transmission line is available via SMA connectors J8 and J9. This transmission line can be used to estimate the loss of the PCB over the environmental conditions being evaluated. An open-ended 50Ω transmission line is also provided at J7 for calibration if needed.

Narrow trace widths are used near each part to improve impedance matching.

Figure 23. Evaluation Board Layouts

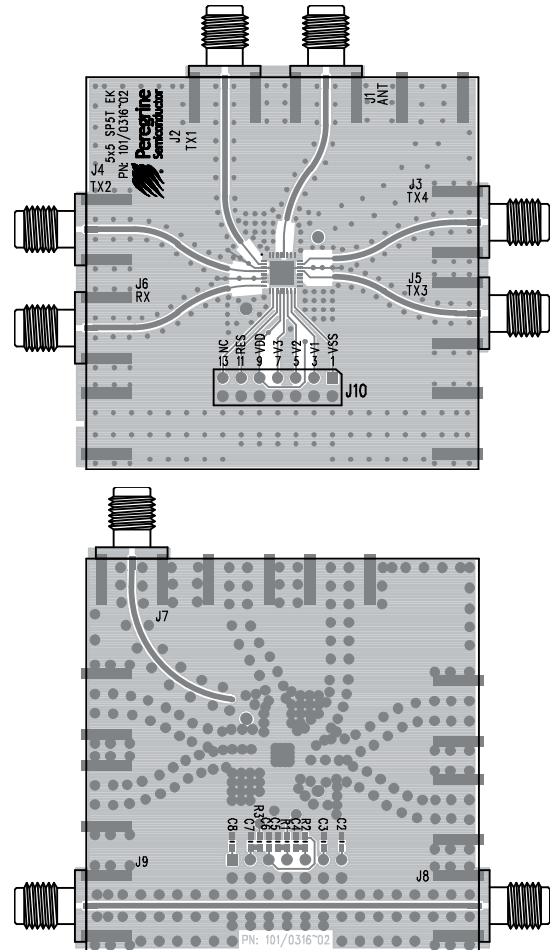

PRT-50283

Figure 24. Evaluation Board Schematic

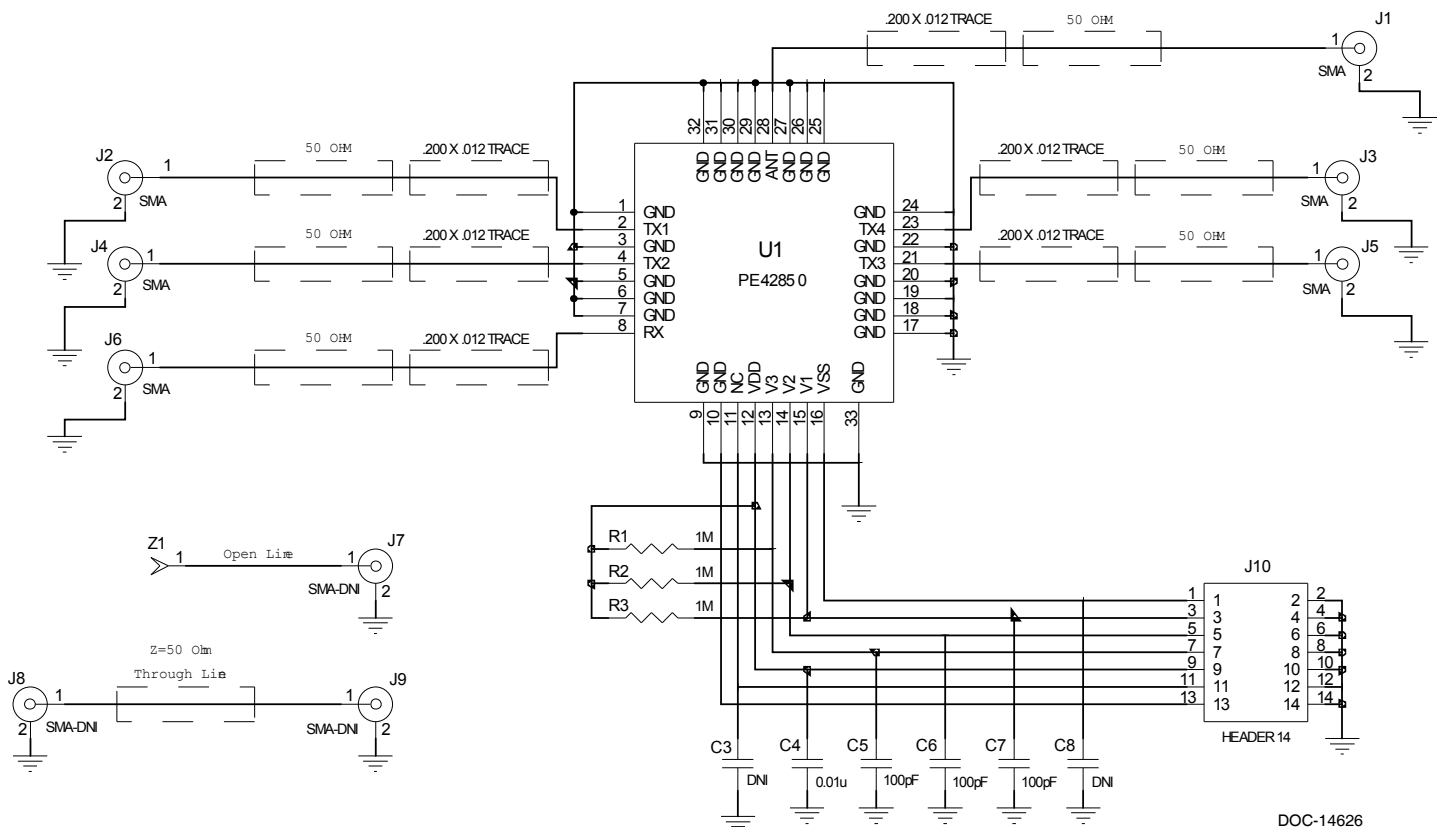

DOC-14626

- Notes: 1. Use 101-0316-02 PCB
2. 32 mil Width, 10 mil Gaps, 28 mil Core, 4.3 Er, and 2.1 mil Cu

Figure 25. Package Drawing
32-lead 5x5 mm QFN

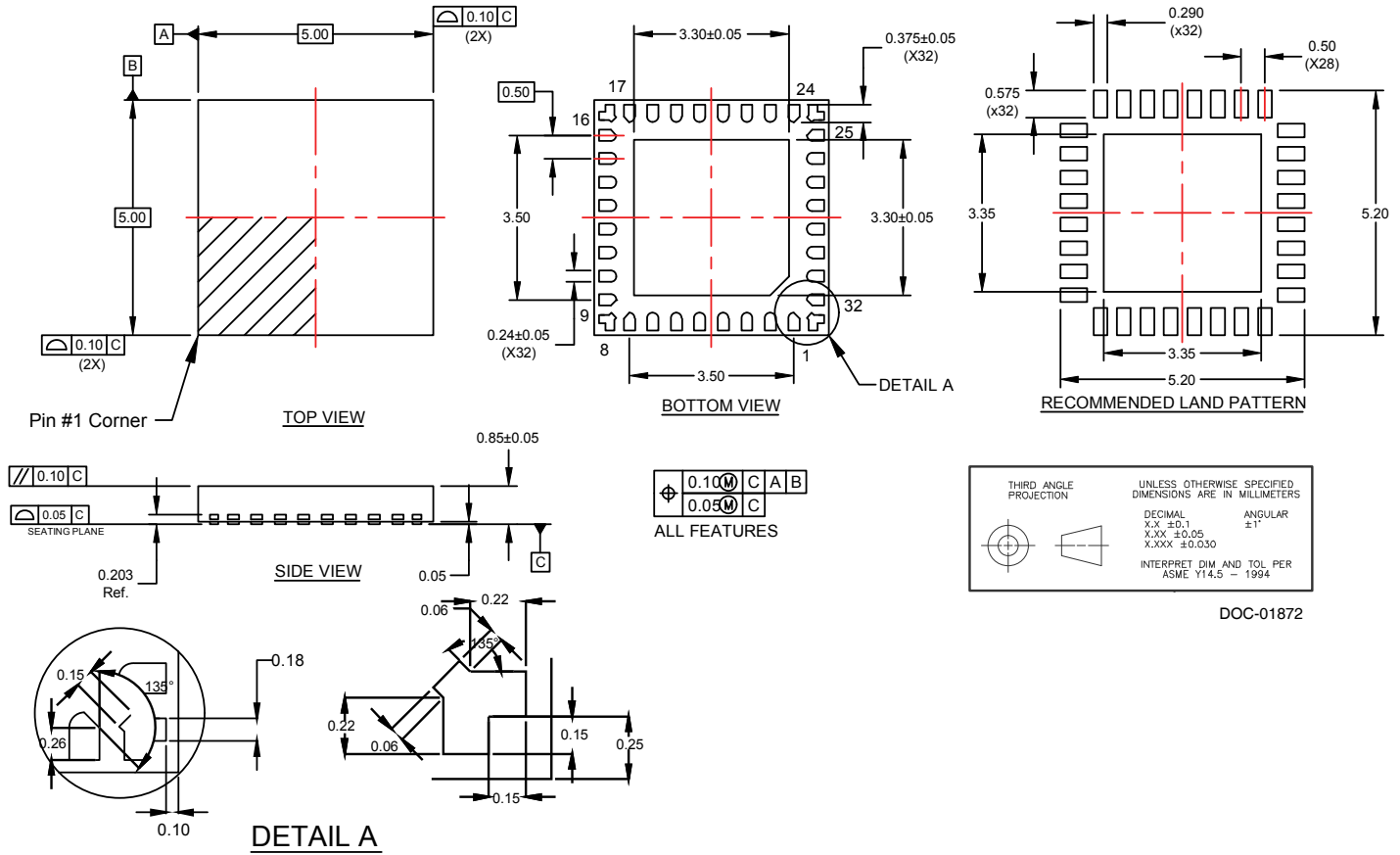

Figure 26. Top Marking Specification



- = Pin 1 designator
- YYWW = Date code, last two digits of the year and work week
- ZZZZZZ = Seven digits of the lot number

DOC-66060

