



Chipsmall Limited consists of a professional team with an average of over 10 year of expertise in the distribution of electronic components. Based in Hongkong, we have already established firm and mutual-benefit business relationships with customers from,Europe,America and south Asia,supplying obsolete and hard-to-find components to meet their specific needs.

With the principle of “Quality Parts,Customers Priority,Honest Operation,and Considerate Service”,our business mainly focus on the distribution of electronic components. Line cards we deal with include Microchip,ALPS,ROHM,Xilinx,Pulse,ON,Everlight and Freescale. Main products comprise IC,Modules,Potentiometer,IC Socket,Relay,Connector.Our parts cover such applications as commercial,industrial, and automotives areas.

We are looking forward to setting up business relationship with you and hope to provide you with the best service and solution. Let us make a better world for our industry!



## Contact us

Tel: +86-755-8981 8866 Fax: +86-755-8427 6832

Email & Skype: info@chipsmall.com Web: www.chipsmall.com

Address: A1208, Overseas Decoration Building, #122 Zhenhua RD., Futian, Shenzhen, China



## 4 PIN LONG CREEPAGE SOP PHOTOTRANSISTOR PHOTOCOUPLER EL101X-G Series

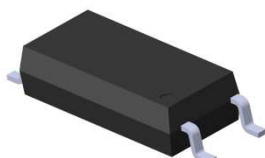

### Features:

- Free halogens compliant
- Current transfer ratio  
(CTR: 50~600% at  $I_F = 5\text{mA}$ ,  $V_{CE} = 5\text{V}$ )  
(CTR: 63~320% at  $I_F = 10\text{mA}$ ,  $V_{CE} = 5\text{V}$ )
- High isolation voltage between input and output ( $V_{iso} = 5000\text{ V rms}$ )
- Compact 4 Pin SOP with a 2.0 mm profile
- 8mm long creepage distance
- Pb free and RoHS compliant.
- UL approved (No. E214129)
- VDE approved (No. 40028391)
- SEMKO approved
- NEMKO approved
- DEMKO approved
- FIMKO approved

### Description

The EL101X-G series devices consist of an infrared emitting diode, optically coupled to a phototransistor detector. Compound use free halogens and  $\text{Sb}_2\text{O}_3$ . They are packaged in a 4-pin SOP package

### Applications

- Programmable controllers
- System appliances, measuring instruments
- Telecommunication equipments
- Home appliances, such as fan heaters, etc.
- Signal transmission between circuits of different potentials and impedances

### Schematic

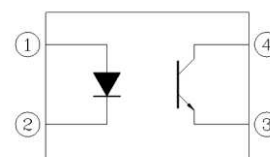

### Pin Configuration

1. Anode
2. Cathode
3. Emitter
4. Collector

**Absolute Maximum Ratings (Ta=25°C)**

|        | Parameter                           | Symbol    | Rating     | Unit             |
|--------|-------------------------------------|-----------|------------|------------------|
| Input  | Forward current                     | $I_F$     | 60         | mA               |
|        | Peak forward current (1us, pulse)   | $I_{FP}$  | 1.5        | A                |
|        | Reverse voltage                     | $V_R$     | 6          | V                |
|        | Power dissipation                   | $P_D$     | 100        | mW               |
| Output | Power dissipation                   | $P_C$     | 150        | mW               |
|        | Collector current                   | $I_C$     | 50         | mA               |
|        | Collector-Emitter voltage           | $V_{CEO}$ | 80         | V                |
|        | Emitter-Collector voltage           | $V_{ECO}$ | 7          | V                |
|        | Total Power Dissipation             | $P_{TOT}$ | 250        | mW               |
|        | Isolation Voltage* <sup>1</sup>     | $V_{ISO}$ | 5000       | V <sub>rms</sub> |
|        | Operating Temperature               | $T_{OPR}$ | -55 to 110 | °C               |
|        | Storage Temperature                 | $T_{STG}$ | -55 to 125 | °C               |
|        | Soldering Temperature* <sup>2</sup> | $T_{SOL}$ | 260        | °C               |

Notes:

\*1 AC for 1 minute, R.H.= 40 ~ 60% R.H. In this test, pins 1, 2 are shorted together, and pins 3, 4 are shorted together.

\*2 For 10 seconds

**Electro-Optical Characteristics (Ta=25°C unless specified otherwise)**

**Input**

| Parameter         | Symbol   | Min. | Typ. | Max. | Unit          | Condition                |
|-------------------|----------|------|------|------|---------------|--------------------------|
| Forward Voltage   | $V_F$    | -    | 1.45 | 1.5  | V             | $I_F = 50\text{mA}$      |
| Reverse current   | $I_R$    | -    | -    | 10   | $\mu\text{A}$ | $V_R = 6\text{V}$        |
| Input capacitance | $C_{in}$ | -    | 50   | -    | pF            | $V = 0, f = 1\text{kHz}$ |

**Output**

| Parameter                           | Symbol     | Min | Typ. | Max. | Unit | Condition                               |
|-------------------------------------|------------|-----|------|------|------|---|
| Collector-Emitter dark current      | $I_{CEO}$  | -   | -    | 100  | nA   | $V_{CE} = 20\text{V}, I_F = 0\text{mA}$ |
| Collector-Emitter breakdown voltage | $BV_{CEO}$ | 80  | -    | -    | V    | $I_C = 0.1\text{mA}$                    |
| Emitter-Collector breakdown voltage | $BV_{ECO}$ | 7   | -    | -    | V    | $I_E = 0.1\text{mA}$                    |

**Transfer Characteristics**

| Parameter                            | Symbol        | Min                | Typ. | Max. | Unit                                   | Condition  |
|--------------------------------------|---------------|--------------------|------|------|--|--|
| Current Transfer ratio               | EL1010        | 50                 | -    | 600  | %                                      | $I_F = 5\text{mA}, V_{CE} = 5\text{V}$             |
|                                      | EL1017        | 80                 | -    | 160  |  |  |
|                                      | EL1018        | 130                | -    | 260  |  |  |
|                                      | EL1019        | 200                | -    | 400  |  |  |
|                                      | EL1012        | 63                 | -    | 125  | %                                      | $I_F = 10\text{mA}, V_{CE} = 5\text{V}$            |
|                                      | EL1013        | 100                | -    | 200  |  |  |
|                                      | EL1014        | 160                | -    | 320  |  |  |
|                                      | EL1012        | 22                 | -    | -    |  |  |
| EL1013                               | 34            | -                  | -    | %    | $I_F = 1\text{mA}, V_{CE} = 5\text{V}$ |  |
| EL1014                               | 56            | -                  | -    |      |  |  |
| Collector-Emitter saturation voltage | $V_{CE(sat)}$ | -                  | -    | 0.3  | V                                      | $I_F = 10\text{mA}, I_C = 1\text{mA}$              |
| Isolation resistance                 | $R_{IO}$      | $5 \times 10^{10}$ | -    | -    | $\Omega$                               | $V_{IO} = 500\text{Vdc}, 40\sim 60\% \text{ R.H.}$ |
| Floating capacitance                 | $C_{IO}$      | -                  | -    | 1.0  | pF                                     | $V_{IO} = 0, f = 1\text{MHz}$                      |

### Transfer Characteristics

| Parameter     | Symbol         | Min | Typ. | Max. | Unit | Condition  |
|---------------|----------------|-----|------|------|------|--|
| Turn on time  | Ton            | -   | 4    | -    | μs   | V <sub>CE</sub> = 5V, I <sub>C</sub> = 5mA,<br>R <sub>L</sub> = 100Ω |
| Turn off time | Toff           | -   | 3    | -    |      |  |
| Rise time     | t <sub>r</sub> | -   | 2    | 18   | μs   | V <sub>CE</sub> = 5V, I <sub>C</sub> = 5mA,<br>R <sub>L</sub> = 100Ω |
| Fall time     | t <sub>f</sub> | -   | 3    | 18   |      |  |

\* Typical values at T<sub>a</sub> = 25°C

Typical Electro-Optical Characteristics Curves

Figure 1. Forward Current vs. Forward Voltage

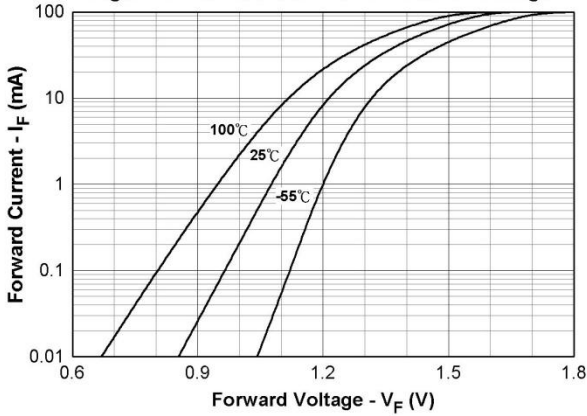

Figure.2 Collector Dark Current vs. Ambient Temperature

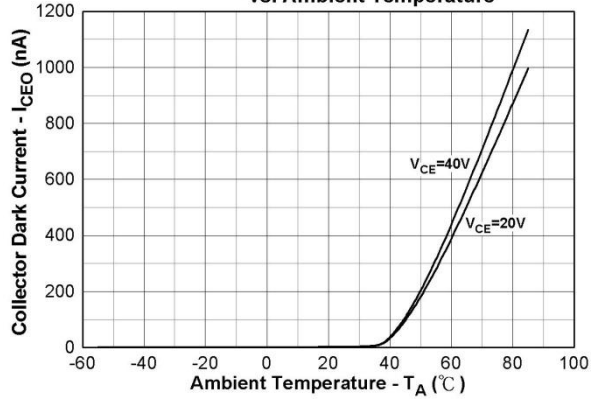

Figure 3. Collector Current vs. Collector Emitter Voltage

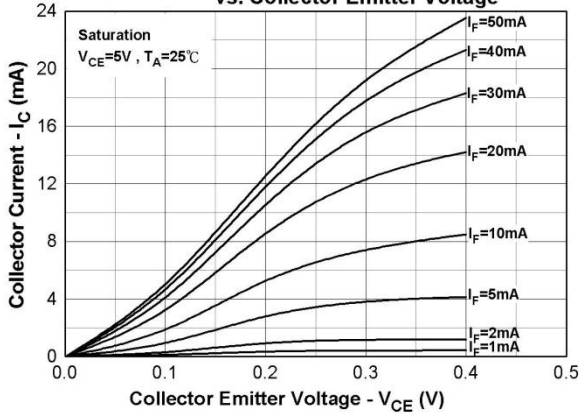

Figure 4. Collector Current vs. Collector Emitter Voltage

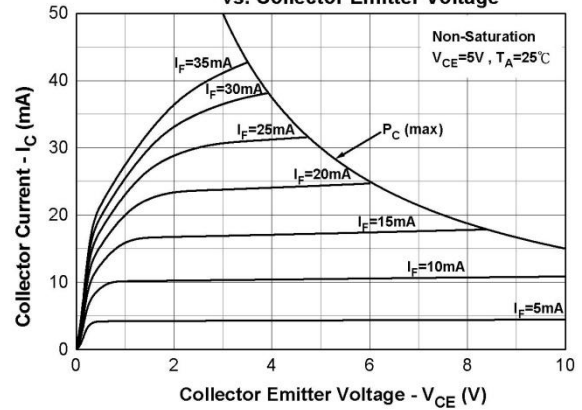

Figure 5. Normalized Collector Current vs. Forward Current

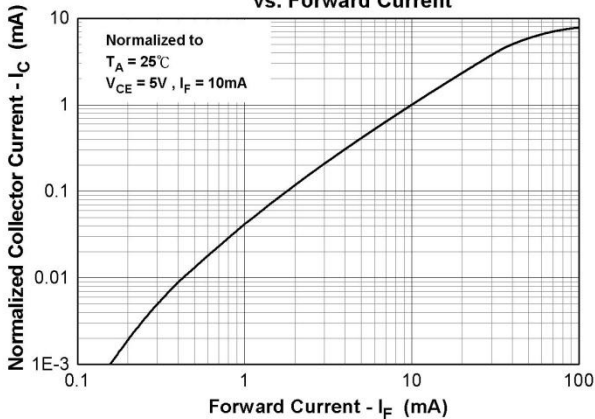

Figure 6. Normalized Current Transfer Ratio vs. Forward Current

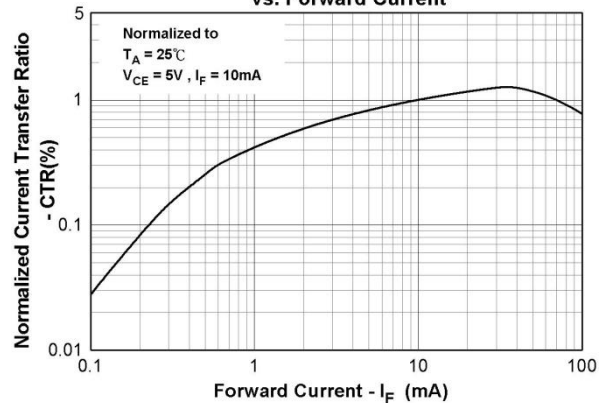

Figure 7. Normalized Current Transfer Ratio vs. Ambient Temperature

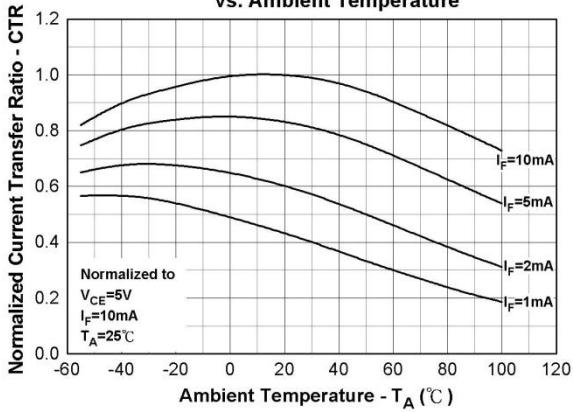

Figure 8. Normalized Current Transfer Ratio vs. Ambient Temperature

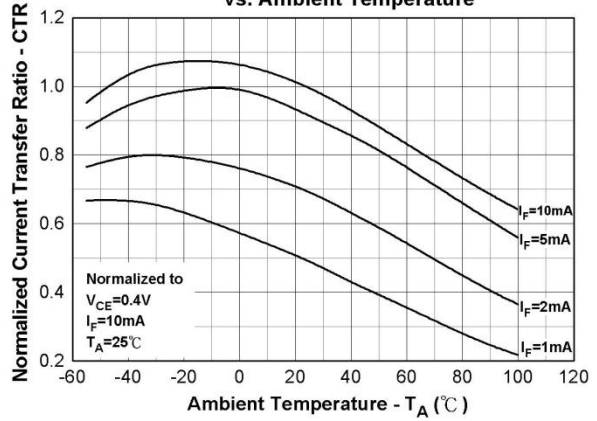

Figure 9. Turn on/off Time vs. Collector Current

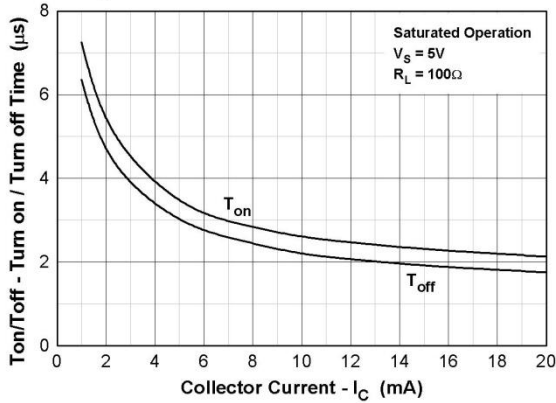

Figure 10. Turn on/off Time vs. Forward Current

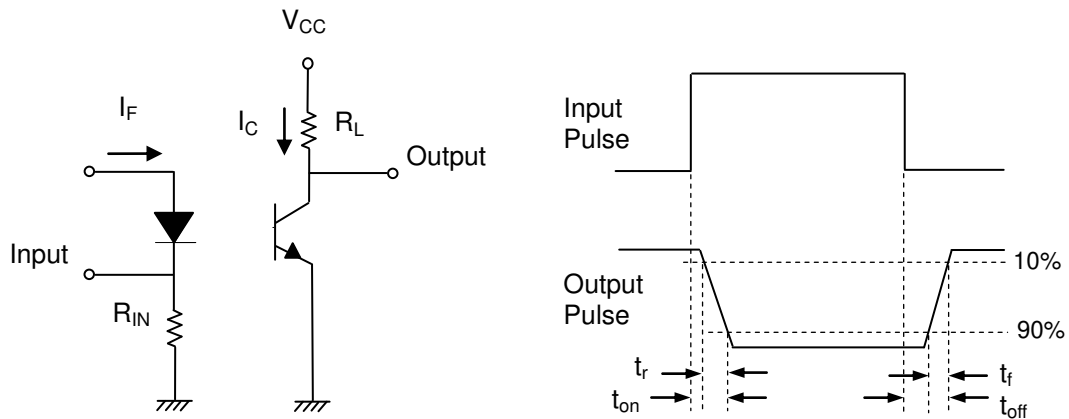
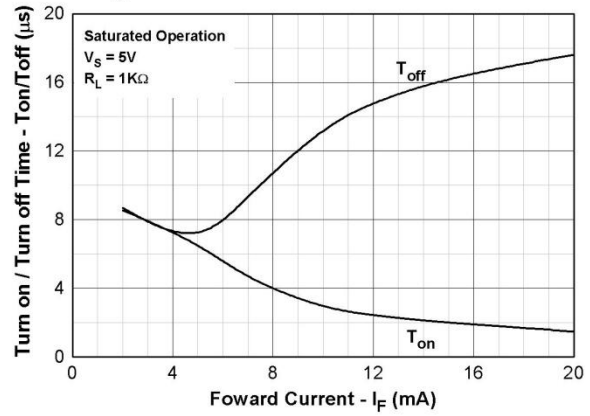

Figure 11. Switching Time Test Circuit & Waveforms

## Order Information

### Part Number

**EL101X(Y)-VG**

### Note

EL101 = Part No.

X = CTR Rank (0, 2, 3, 4, 7, 8 or 9)

Y = Tape and reel option (TA, TB or none).

V = VDE safety (optional)

G = Halogens free

| Option | Description                 | Packing quantity    |
|--------|-----------------------------|---------------------|
| None   | Standard SMD option         | 100 units per tube  |
| -V     | Standard SMD option + VDE   | 100 units per tube  |
| (TA)   | TA Tape & reel option       | 3000 units per reel |
| (TB)   | TB Tape & reel option       | 3000 units per reel |
| (TA)-V | TA Tape & reel option + VDE | 3000 units per reel |
| (TB)-V | TB Tape & reel option + VDE | 3000 units per reel |



Package Dimension (Dimensions in mm)

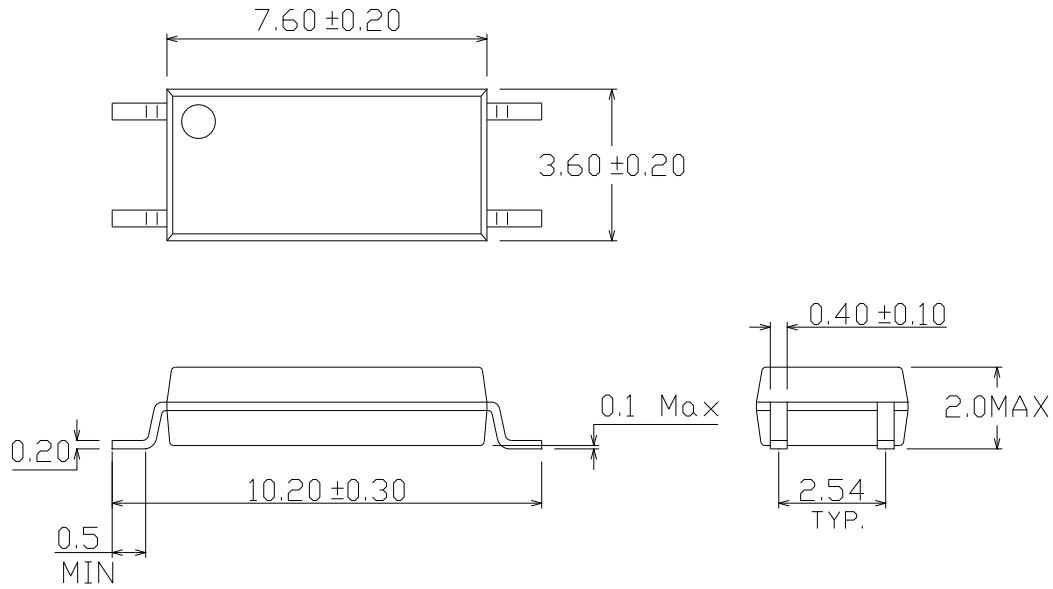

Recommended pad layout for surface mount leadform

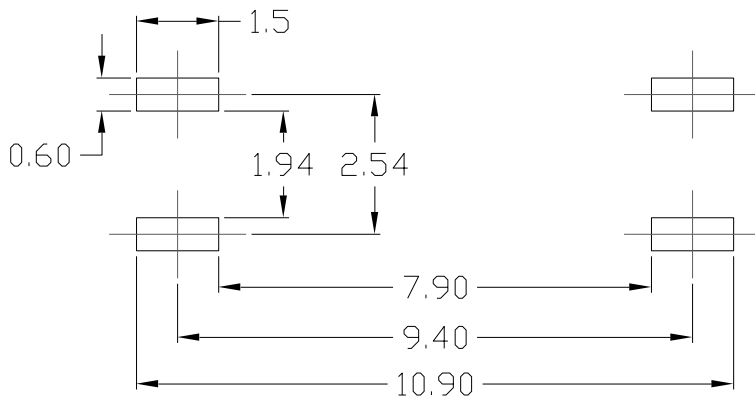

## Device Marking

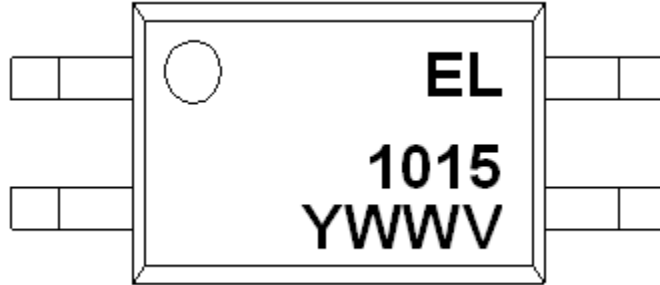

## Notes

|      |                           |
|------|---------------------------|
| EL   | denotes Everlight         |
| 1015 | denotes Device Number     |
| Y    | denotes 1 digit Year code |
| WW   | denotes 2 digit Week code |
| V    | denotes VDE (optional)    |

**Tape & Reel Packing Specifications**

**Option TA**

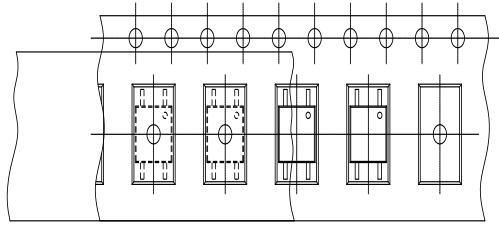

Direction of feed from reel

**Option TB**

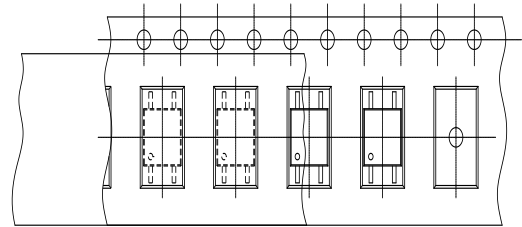

Direction of feed from reel

**Tape dimensions**

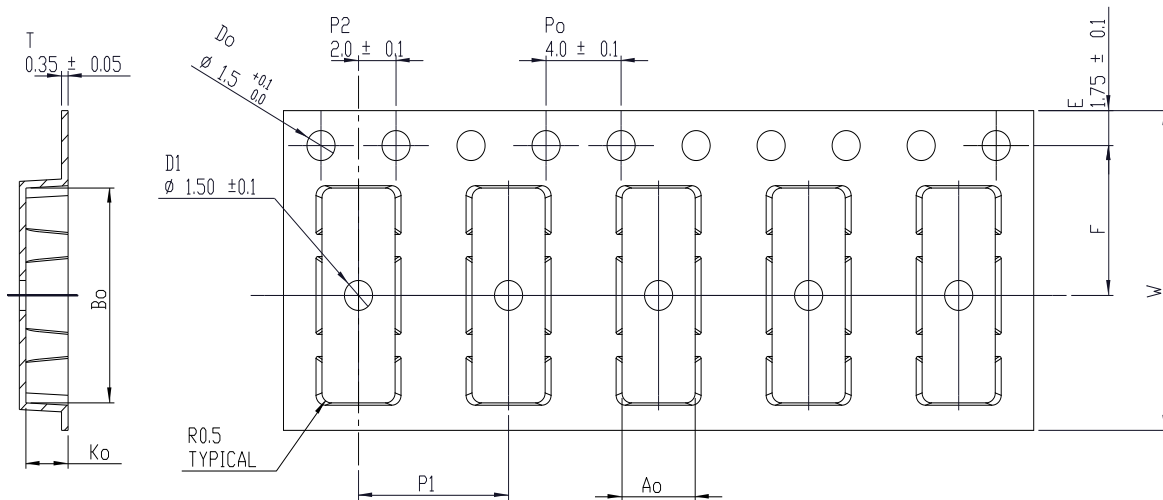

|                |                |                  |                |                 |                 |                 |
|----------------|----------------|------------------|----------------|-----------------|-----------------|-----------------|
| Dimension No.  | <b>Ao</b>      | <b>Bo</b>        | <b>Do</b>      | <b>D1</b>       | <b>E</b>        | <b>F</b>        |
| Dimension (mm) | $3.9 \pm 0.10$ | $10.75 \pm 0.10$ | $1.5 + 0.1/-0$ | $1.5 \pm 0.10$  | $1.75 \pm 0.10$ | $7.5 \pm 0.10$  |
| Dimension No.  | <b>Po</b>      | <b>P1</b>        | <b>P2</b>      | <b>T</b>        | <b>W</b>        | <b>Ko</b>       |
| Dimension (mm) | $4.0 \pm 0.10$ | $8.0 \pm 0.10$   | $2.0 \pm 0.10$ | $0.35 \pm 0.05$ | $16.0 \pm 0.30$ | $2.25 \pm 0.10$ |

## Precautions for Use

### 1. Soldering Condition

#### 1.1 (A) Maximum Body Case Temperature Profile for evaluation of Reflow Profile

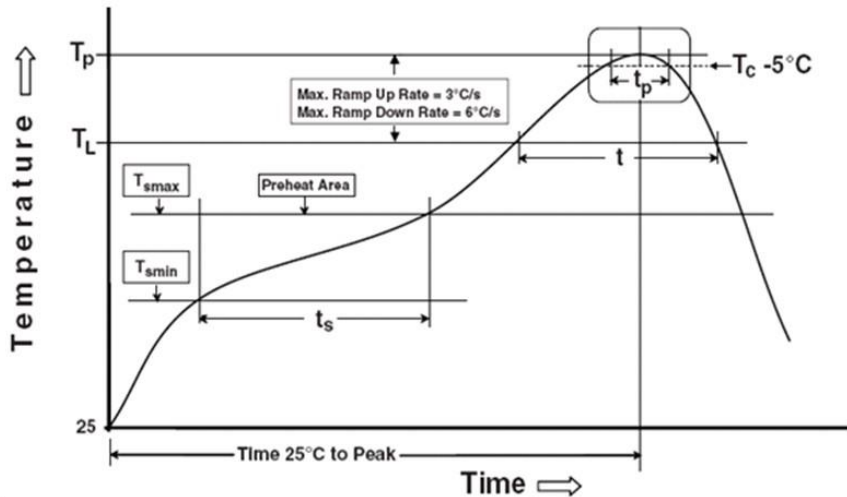

Note:

Reference: IPC/JEDEC J-STD-020D

#### Preheat

|  |                 |
|--|-----------------|
| Temperature min ( $T_{smin}$ )               | 150 °C          |
| Temperature max ( $T_{smax}$ )               | 200°C           |
| Time ( $T_{smin}$ to $T_{smax}$ ) ( $t_s$ )  | 60-120 seconds  |
| Average ramp-up rate ( $T_{smax}$ to $T_p$ ) | 3 °C/second max |

#### Other

|  |                  |
|--|------------------|
| Liquidus Temperature ( $T_L$ )                                       | 217 °C           |
| Time above Liquidus Temperature ( $t_L$ )                            | 60-100 sec       |
| Peak Temperature ( $T_p$ )   | 260°C            |
| Time within 5 °C of Actual Peak Temperature: $T_p - 5^\circ\text{C}$ | 30 s             |
| Ramp- Down Rate from Peak Temperature                                | 6°C /second max. |
| Time 25°C to peak temperature  | 8 minutes max.   |
| Reflow times   | 3 times          |

## **DISCLAIMER**

1. Above specification may be changed without notice. EVERLIGHT will reserve authority on material change for above specification.
2. When using this product, please observe the absolute maximum ratings and the instructions for using outlined in these specification sheets. EVERLIGHT assumes no responsibility for any damage resulting from use of the product which does not comply with the absolute maximum ratings and the instructions included in these specification sheets.
3. These specification sheets include materials protected under copyright of EVERLIGHT corporation. Please don't reproduce or cause anyone to reproduce them without EVERLIGHT's consent.