



Chipsmall Limited consists of a professional team with an average of over 10 year of expertise in the distribution of electronic components. Based in Hongkong, we have already established firm and mutual-benefit business relationships with customers from,Europe,America and south Asia,supplying obsolete and hard-to-find components to meet their specific needs.

With the principle of “Quality Parts,Customers Priority,Honest Operation,and Considerate Service”,our business mainly focus on the distribution of electronic components. Line cards we deal with include Microchip,ALPS,ROHM,Xilinx,Pulse,ON,Everlight and Freescale. Main products comprise IC,Modules,Potentiometer,IC Socket,Relay,Connector.Our parts cover such applications as commercial,industrial, and automotives areas.

We are looking forward to setting up business relationship with you and hope to provide you with the best service and solution. Let us make a better world for our industry!



Contact us

Tel: +86-755-8981 8866 Fax: +86-755-8427 6832

Email & Skype: info@chipsmall.com Web: www.chipsmall.com

Address: A1208, Overseas Decoration Building, #122 Zhenhua RD., Futian, Shenzhen, China



OBSOLETE PRODUCT	RECOMMENDED REPLACEMENT
EL5144	EL8101
EL5146	EL8100
EL5244	EL8201
EL5246	EL8200
EL5444	EL8401

Single-Supply Rail-to-Rail Amplifiers

The EL5144 series amplifiers are voltage-feedback, high speed, rail-to-rail amplifiers designed to operate on a single +5V supply. They offer unity gain stability with an unloaded -3dB bandwidth of 100MHz. The input common-mode voltage range extends from the negative rail to within 1.5V of the positive rail. Driving a 75W double terminated coaxial cable, the EL5144 series amplifiers drive to within 150mV of either rail. The 200V/ μ s slew rate and 0.1%/0.1° differential gain/differential phase makes these parts ideal for composite and component video applications. With their voltage feedback architecture, these amplifiers can accept reactive feedback networks, allowing them to be used in analog filtering applications. These amplifiers will source 90mA and sink 65mA.

The EL5146 and EL5246 have a power-savings disable feature. Applying a standard TTL low logic level to the CE (Chip Enable) pin reduces the supply current to 2.6 μ A within 10ns. Turn-on time is 500ns, allowing true break-before-make conditions for multiplexing applications. Allowing the CE pin to float or applying a high logic level will enable the amplifier.

For applications where board space is critical, singles are offered in a 5 Ld SOT-23 package, duals in 8 Ld and 10 Ld MSOP packages, and quads in a 16 Ld QSOP package. Singles, duals, and quads are also available in industry standard pinouts in SO and PDIP packages. All parts operate over the industrial temperature range of -40°C to +85°C.

Features

- Rail-to-rail output swing
- -3dB bandwidth = 100MHz
- Single-supply +5V operation
- Power-down to 2.6 μ A
- Large input common-mode range $0V < V_{CM} < 3.5V$
- Diff gain/phase = 0.1%/0.1°
- Low power 35mW per amplifier
- Space-saving SOT23-5, 8 Ld MSOP and 10 Ld MSOP, and 16 Ld QSOP packages
- Pb-Free available (RoHS compliant)

Applications

- Video amplifiers
- 5V analog signal processing
- Multiplexers
- Line drivers
- Portable computers
- High speed communications
- Sample and hold amplifiers
- Comparators

Ordering Information

PART NUMBER	PART MARKING	PACKAGE	PKG. DWG. #
EL5144CW	J	5 Ld SOT-23**	MDP0038
EL5144CW-T7*	J	5 Ld SOT-23**	MDP0038
EL5144CW-T7A*	J	5 Ld SOT-23**	MDP0038
EL5144CWZ-T7* (Note)	BAHA	5 Ld SOT-23** (Pb-free)	MDP0038
EL5144CWZ-T7A* (Note)	BAHA	5 Ld SOT-23** (Pb-free)	MDP0038
EL5146CN	EL5146CN	8 Ld PDIP	MDP0031
EL5146CS	5146CS	8 Ld SOIC	MDP0027
EL5146CS-T7*	5146CS	8 Ld SOIC	MDP0027
EL5146CS-T13*	5146CS	8 Ld SOIC	MDP0027
EL5146CSZ (Note)	5146CSZ	8 Ld SOIC (Pb-free)	MDP0027
EL5146CSZ-T7* (Note)	5146CSZ	8 Ld SOIC (Pb-free)	MDP0027
EL5146CSZ-T13* (Note)	5146CSZ	8 Ld SOIC (Pb-free)	MDP0027
EL5244CN	EL5244CN	8 Ld PDIP	MDP0031
EL5244CS	5244CS	8 Ld SOIC	MDP0027
EL5244CS-T7*	5244CS	8 Ld SOIC	MDP0027
EL5244CS-T13*	5244CS	8 Ld SOIC	MDP0027
EL5244CSZ (Note)	5244CSZ	8 Ld SOIC (Pb-free)	MDP0027
EL5244CSZ-T7* (Note)	5244CSZ	8 Ld SOIC (Pb-free)	MDP0027
EL5244CSZ-T13* (Note)	5244CSZ	8 Ld SOIC (Pb-free)	MDP0027
EL5244CY	H	8 Ld MSOP	MDP0043
EL5244CY-T13*	H	8 Ld MSOP	MDP0043
EL5244CYZ (Note)	BAVAA	8 Ld MSOP (Pb-free)	MDP0043
EL5244CYZ-T7* (Note)	BAVAA	8 Ld MSOP (Pb-free)	MDP0043
EL5244CYZ-T13* (Note)	BAVAA	8 Ld MSOP (Pb-free)	MDP0043
EL5246CN	EL5246CN	14 Ld PDIP	MDP0031
EL5246CS	5246CS	14 Ld SOIC	MDP0027
EL5246CS-T7*	5246CS	14 Ld SOIC	MDP0027
EL5246CS-T13*	5246CS	14 Ld SOIC	MDP0027
EL5246CSZ (Note)	5246CSZ	14 Ld SOIC (Pb-free)	MDP0027
EL5246CSZ-T7* (Note)	5246CSZ	14 Ld SOIC (Pb-free)	MDP0027
EL5246CSZ-T13* (Note)	5246CSZ	14 Ld SOIC (Pb-free)	MDP0027
EL5246CY	C	10 Ld MSOP	MDP0043
EL5246CY-T13*	C	10 Ld MSOP	MDP0043
EL5246CYZ (Note)	BAWAA	10 Ld MSOP (Pb-free)	MDP0043
EL5246CYZ-T7* (Note)	BAWAA	10 Ld MSOP (Pb-free)	MDP0043
EL5246CYZ-T13* (Note)	BAWAA	10 Ld MSOP (Pb-free)	MDP0043
EL5444CN	EL5444CN	14 Ld PDIP	MDP0031
EL5444CS	5444CS	14 Ld SOIC	MDP0027
EL5444CS-T7*	5444CS	14 Ld SOIC	MDP0027
EL5444CS-T13*	5444CS	14 Ld SOIC	MDP0027

Ordering Information (Continued)

PART NUMBER	PART MARKING	PACKAGE	PKG. DWG. #
EL5444CSZ (Note)	5444CSZ	14 Ld SOIC (Pb-free)	MDP0027
EL5444CSZ-T7* (Note)	5444CSZ	14 Ld SOIC (Pb-free)	MDP0027
EL5444CSZ-T13* (Note)	5444CSZ	14 Ld SOIC (Pb-free)	MDP0027
EL5444CU	5444CU	16 Ld QSOP	MDP0040
EL5444CU-T13*	5444CU	16 Ld QSOP	MDP0040
EL5444CUZ (Note)	5444CUZ	16 Ld QSOP (Pb-free)	MDP0040
EL5444CUZ-T7* (Note)	5444CUZ	16 Ld QSOP (Pb-free)	MDP0040
EL5444CUZ-T13* (Note)	5444CUZ	16 Ld QSOP (Pb-free)	MDP0040

*Please refer to [TB347](#) for details on reel specifications.

**EL5144CW symbol is .Jxxx where xxx represents date

NOTE: These Intersil Pb-free plastic packaged products employ special Pb-free material sets, molding compounds/die attach materials, and 100% matte tin plate plus anneal (e3 termination finish, which is RoHS compliant and compatible with both SnPb and Pb-free soldering operations). Intersil Pb-free products are MSL classified at Pb-free peak reflow temperatures that meet or exceed the Pb-free requirements of IPC/JEDEC J STD-020.

Pinouts

EL5144
(5 LD SOT-23)
TOP VIEW

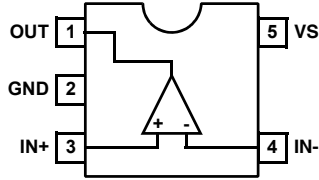

EL5146
(8 LD SO, PDIP)
TOP VIEW

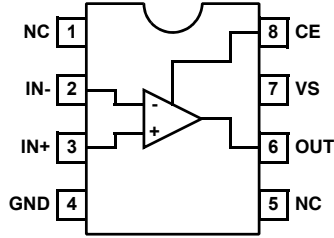

EL5244
(8 LD SOIC, PDIP, MSOP)
TOP VIEW

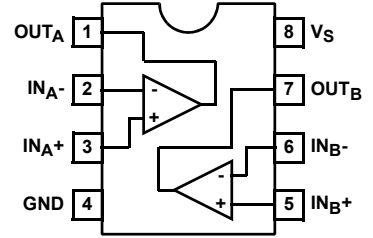

EL5246
(10 LD MSOP)
TOP VIEW

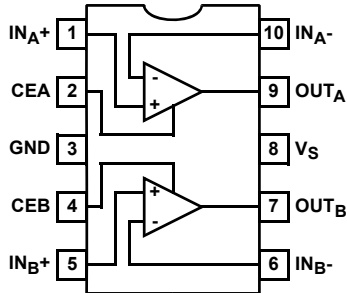

EL5246
(14 LD SOIC, PDIP)
TOP VIEW

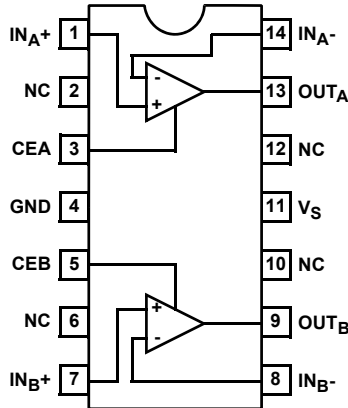

EL5444
(14 LD SOIC, PDIP)
TOP VIEW

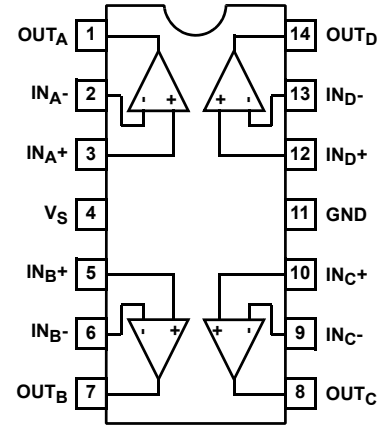

EL5444
(16 LD QSOP)
TOP VIEW

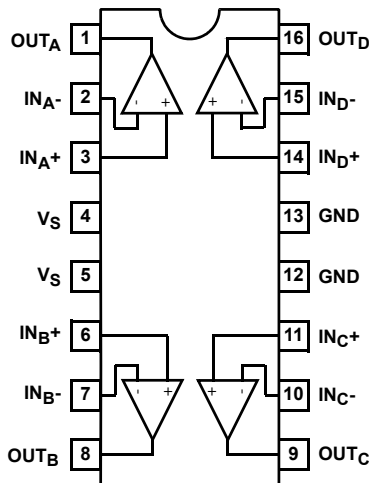

EL5144, EL5146, EL5244, EL5246, EL5444

Absolute Maximum Ratings ($T_A = +25^\circ\text{C}$)

Supply Voltage between V_S and GND +6V
 Pin Voltages GND -0.5V to V_S +0.5V
 Maximum Continuous Output Current 50mA

Thermal Information

Power Dissipation See Curves
 Storage Temperature -65°C to +150°C
 Pb-Free Reflow Profile see link below
<http://www.intersil.com/pbfree/Pb-FreeReflow.asp>

Operating Conditions

Operating Temperature -40°C to +85°C

CAUTION: Do not operate at or near the maximum ratings listed for extended periods of time. Exposure to such conditions may adversely impact product reliability and result in failures not covered by warranty.

IMPORTANT NOTE: All parameters having Min/Max specifications are guaranteed. Typical values are for information purposes only. Unless otherwise noted, all tests are at the specified temperature and are pulsed tests, therefore: $T_J = T_C = T_A$

Electrical Specifications $V_S = +5\text{V}$, $\text{GND} = 0\text{V}$, $T_A = +25^\circ\text{C}$, $\text{CE} = +2\text{V}$, unless otherwise specified.

PARAMETER	DESCRIPTION	CONDITIONS	MIN	TYP	MAX	UNIT
AC PERFORMANCE						
d_G	Differential Gain Error (Note 1)	$G = 2$, $R_L = 150\Omega$ to 2.5V, $R_F = 1\text{k}\Omega$		0.1		%
d_P	Differential Phase Error (Note 1)	$G = 2$, $R_L = 150\Omega$ to 2.5V, $R_F = 1\text{k}\Omega$		0.1		°
BW	Bandwidth	-3dB, $G = 1$, $R_L = 10\text{k}\Omega$, $R_F = 0$		100		MHz
		-3dB, $G = 1$, $R_L = 150\Omega$, $R_F = 0$		60		MHz
BW1	Bandwidth	$\pm 0.1\text{dB}$, $G = 1$, $R_L = 150\Omega$ to GND, $R_F = 0$		8		MHz
GBWP	Gain Bandwidth Product			60		MHz
SR	Slew Rate	$G = 1$, $R_L = 150\Omega$ to GND, $R_F = 0$, $V_O = 0.5\text{V}$ to 3.5V	150	200		V/ μs
t_s	Settling Time	to 0.1%, $V_{OUT} = 0\text{V}$ to 3V		35		ns
DC PERFORMANCE						
A_{VOL}	Open Loop Voltage Gain	$R_L = \text{no load}$, $V_{OUT} = 0.5\text{V}$ to 3V	54	65		dB
		$R_L = 150\Omega$ to GND, $V_{OUT} = 0.5\text{V}$ to 3V	40	50		dB
V_{OS}	Offset Voltage	$V_{CM} = 1\text{V}$, SOT23-5 and MSOP packages			25	mV
		$V_{CM} = 1\text{V}$, All other packages			15	mV
$T_C V_{OS}$	Input Offset Voltage Temperature Coefficient			10		mV/°C
I_B	Input Bias Current	$V_{CM} = 0\text{V}$ and 3.5V		2	100	nA
INPUT CHARACTERISTICS						
CMIR	Common Mode Input Range	$\text{CMRR} \geq 47\text{dB}$	0		3.5	V
CMRR	Common Mode Rejection Ratio	DC, $V_{CM} = 0$ to 3.0V	50	60		dB
		DC, $V_{CM} = 0$ to 3.5V	47	60		dB
R_{IN}	Input Resistance			1.5		G Ω
C_{IN}	Input Capacitance			1.5		pF
OUTPUT CHARACTERISTICS						
V_{OP}	Positive Output Voltage Swing	$R_L = 150\Omega$ to 2.5V (Note 2)	4.70	4.85		V
		$R_L = 150\Omega$ to GND (Note 2)	4.20	4.65		V
		$R_L = 1\text{k}\Omega$ to 2.5V (Note 2)	4.95	4.97		V
V_{ON}	Negative Output Voltage Swing	$R_L = 150\Omega$ to 2.5V (Note 2)		0.15	0.30	V
		$R_L = 150\Omega$ to GND (Note 2)		0		V
		$R_L = 1\text{k}\Omega$ to 2.5V (Note 2)		0.03	0.05	V

EL5144, EL5146, EL5244, EL5246, EL5444

Electrical Specifications $V_S = +5V$, $GND = 0V$, $T_A = +25^\circ C$, $CE = +2V$, unless otherwise specified. (Continued)

PARAMETER	DESCRIPTION	CONDITIONS	MIN	TYP	MAX	UNIT
+I _{OUT}	Positive Output Current	$R_L = 10\Omega$ to 2.5V	60	90	150	mA
-I _{OUT}	Negative Output Current	$R_L = 10\Omega$ to 2.5V	-50	-65	-125	mA
ENABLE (EL5146 AND EL5246 ONLY)						
t _{EN}	Enable Time	EL5146, EL5246		500		ns
t _{DIS}	Disable Time	EL5146, EL5246		10		ns
I _{IHCE}	CE Pin Input High Current	CE = 5V, EL5146, EL5246		0.003	1	mA
I _{ILCE}	CE Pin Input Low Current	CE = 0V, EL5146, EL5246		-1.2	-3	mA
V _{IHCE}	CE Pin Input High Voltage for Power-Up	EL5146, EL5246	2.0			V
V _{ILCE}	CE Pin Input Low Voltage for Power-Down	EL5146, EL5246			0.8	V
SUPPLY						
I _{SON}	Supply Current - Enabled (Per Amplifier)	No load, $V_{IN} = 0V$, CE = 5V		7	8.8	mA
I _{SOFF}	Supply Current - Disabled (Per Amplifier)	No load, $V_{IN} = 0V$, CE = 0V, EL5146 and EL5246 only		2.6	5	mA
PSOR	Power Supply Operating Range		4.75	5.0	5.25	V
PSRR	Power Supply Rejection Ratio	DC, $V_S = 4.75V$ to 5.25V	50	60		dB

NOTES:

- Standard NTSC test, AC signal amplitude = 286mV_{P-P}, f = 3.8MHz, V_{OUT} is swept from 0.8V to 3.4V, R_L is DC-coupled.
- R_L is total load resistance due to feedback resistor and load resistor.

Typical Performance Curves

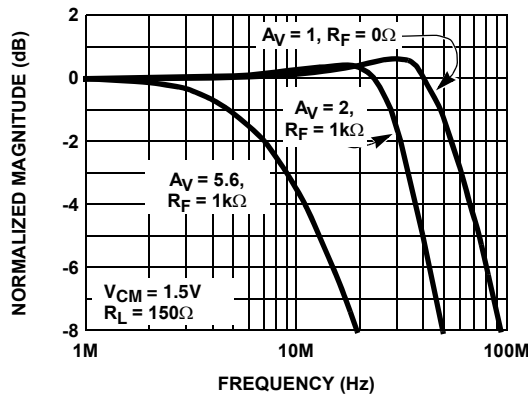

FIGURE 1. NON-INVERTING FREQUENCY RESPONSE (GAIN)

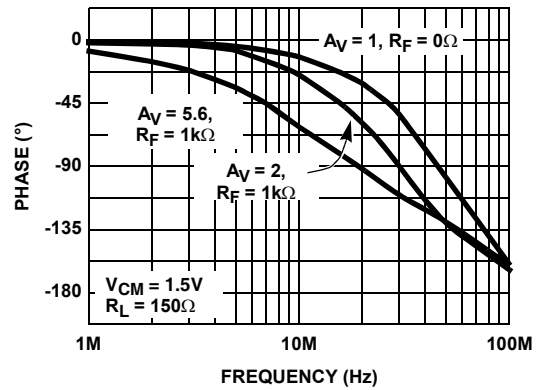

FIGURE 2. NON-INVERTING FREQUENCY RESPONSE (PHASE)

Typical Performance Curves

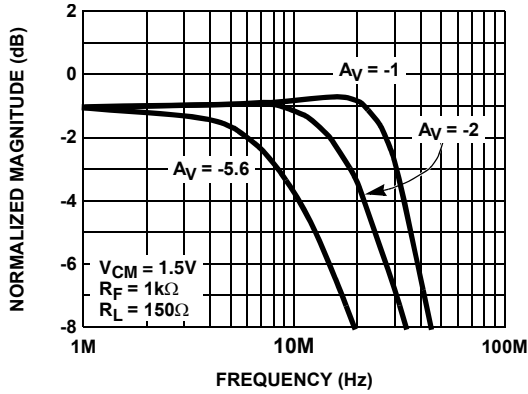

FIGURE 3. INVERTING FREQUENCY RESPONSE (GAIN)

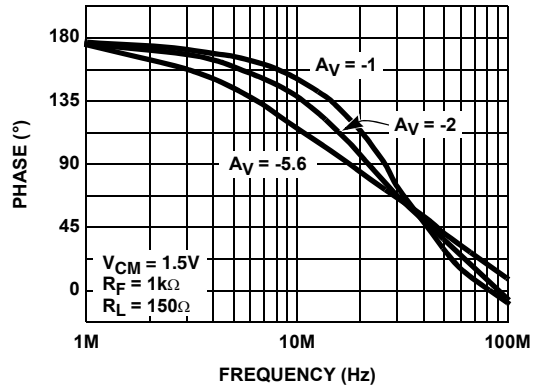

FIGURE 4. INVERTING FREQUENCY RESPONSE (PHASE)

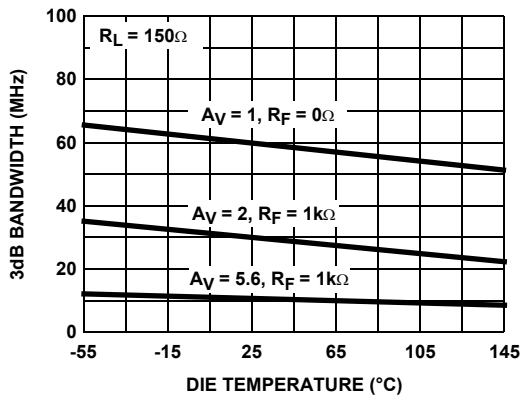

FIGURE 5. 3dB BANDWIDTH vs DIE TEMPERATURE FOR VARIOUS GAINS

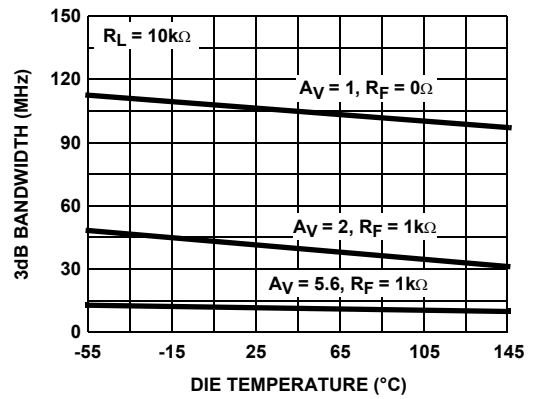

FIGURE 6. 3dB BANDWIDTH VS DIE TEMPERATURE FOR VARIOUS GAINS

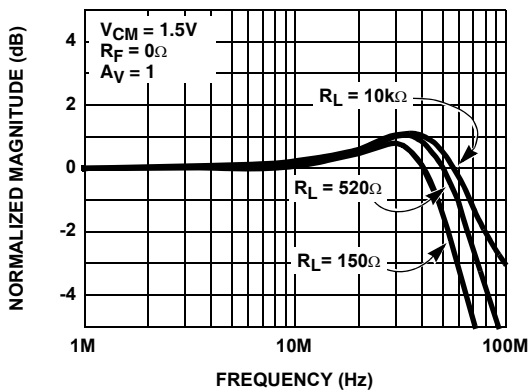

FIGURE 7. FREQUENCY RESPONSE FOR VARIOUS R_L

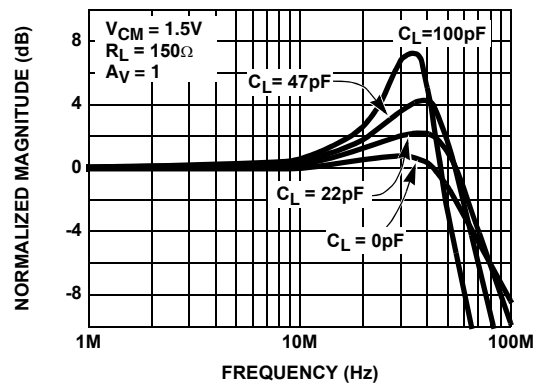

FIGURE 8. FREQUENCY RESPONSE FOR VARIOUS C_L

Typical Performance Curves

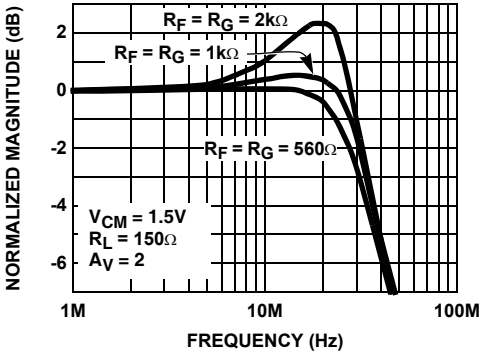

FIGURE 9. FREQUENCY RESPONSE FOR VARIOUS R_F AND R_G

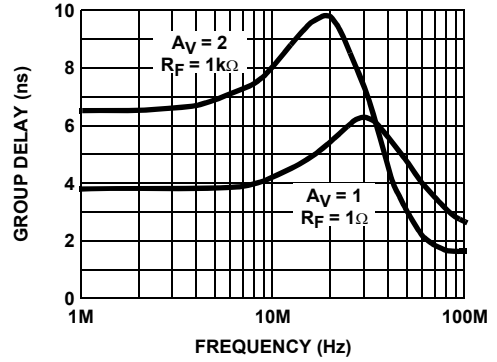

FIGURE 10. GROUP DELAY vs FREQUENCY

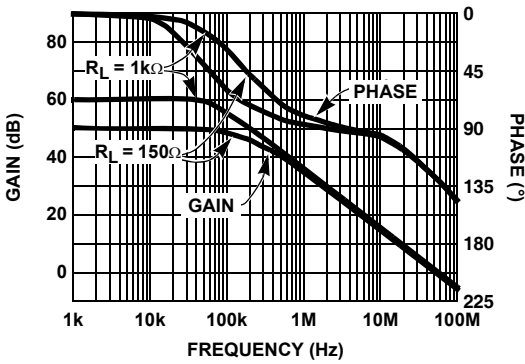

FIGURE 11. OPEN LOOP GAIN AND PHASE vs FREQUENCY

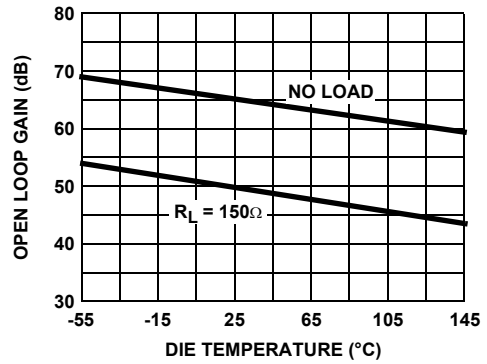

FIGURE 12. OPEN LOOP VOLTAGE GAIN vs DIE TEMPERATURE

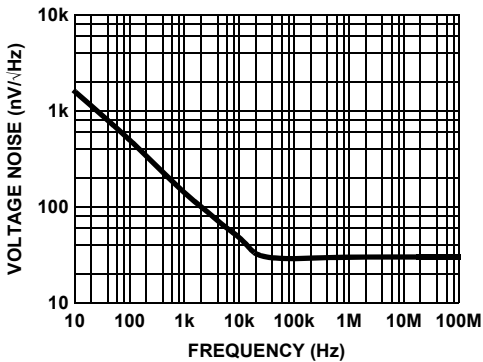

FIGURE 13. VOLTAGE NOISE vs FREQUENCY - VIDEO AMP

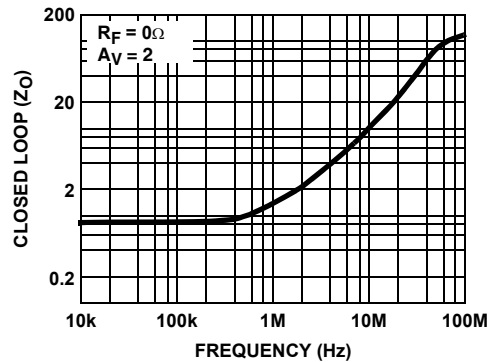

FIGURE 14. CLOSED LOOP OUTPUT IMPEDANCE vs FREQUENCY

Typical Performance Curves

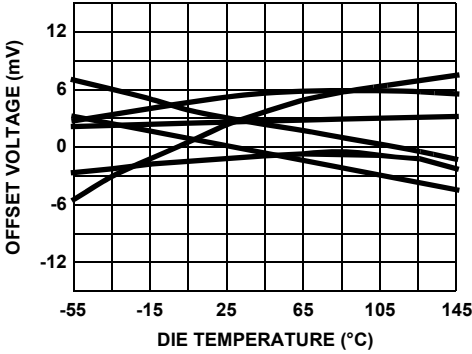

FIGURE 15. OFFSET VOLTAGE vs DIE TEMPERATURE (6 TYPICAL SAMPLES)

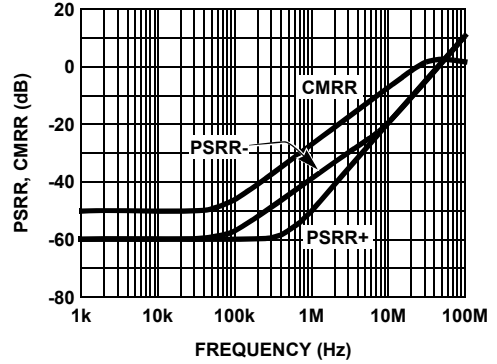

FIGURE 16. PSRR AND CMRR vs FREQUENCY

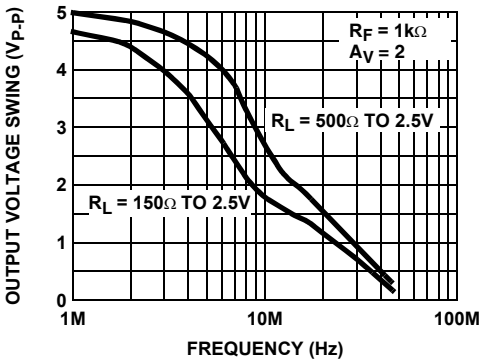

FIGURE 17. OUTPUT VOLTAGE SWING vs FREQUENCY FOR THD < 1%

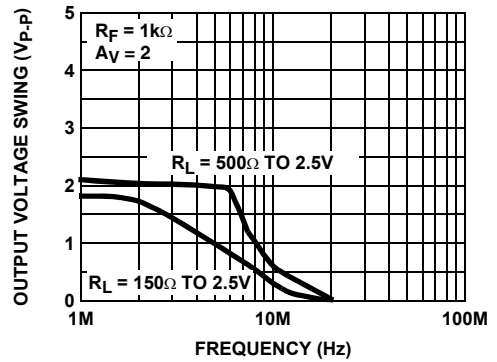

FIGURE 18. OUTPUT VOLTAGE SWING vs FREQUENCY FOR THD < 0.1%

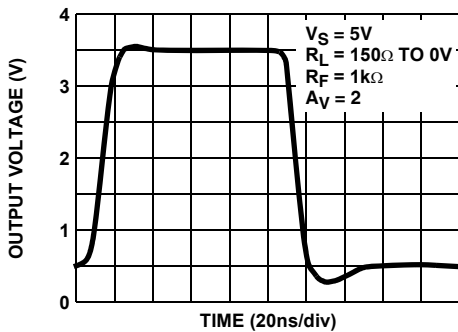

FIGURE 19. LARGE SIGNAL PULSE RESPONSE (SINGLE SUPPLY)

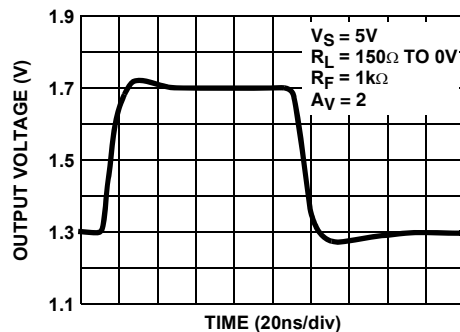

FIGURE 20. SMALL SIGNAL PULSE RESPONSE (SINGLE SUPPLY)

Typical Performance Curves

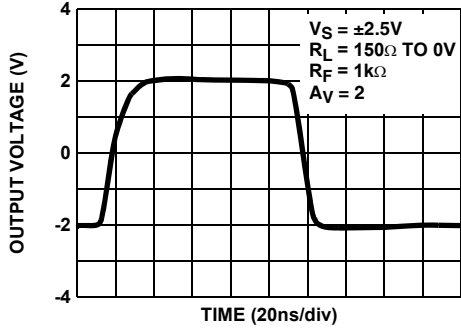

FIGURE 21. LARGE SIGNAL PULSE RESPONSE (SPLIT SUPPLIES)

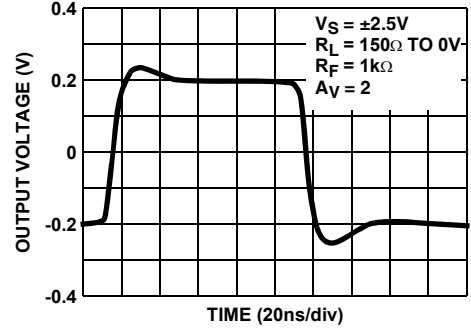

FIGURE 22. SMALL SIGNAL PULSE RESPONSE (SPLIT SUPPLY)

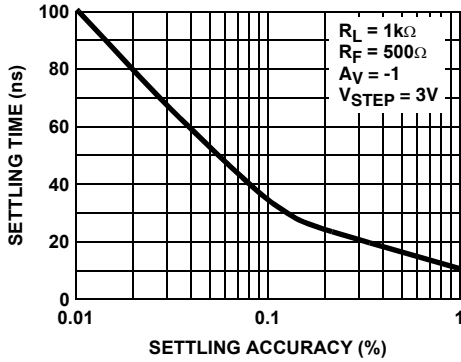

FIGURE 23. SETTLING TIME vs SETTLING ACCURACY

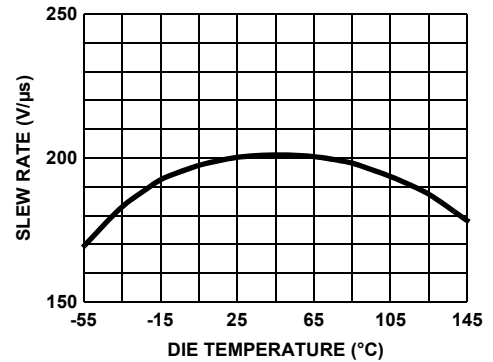

FIGURE 24. SLEW RATE vs DIE TEMPERATURE

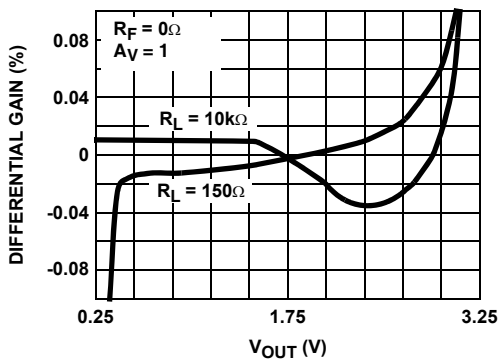

FIGURE 25. DIFFERENTIAL GAIN FOR R_L TIED TO 0V

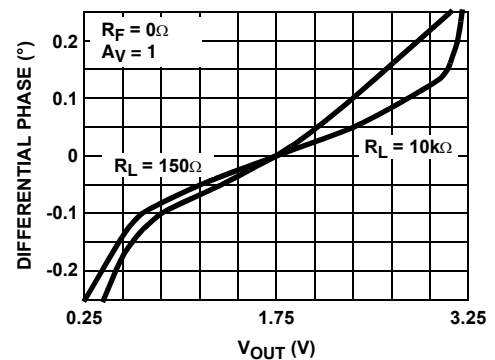

FIGURE 26. DIFFERENTIAL PHASE FOR R_L TIED TO 0V

Typical Performance Curves

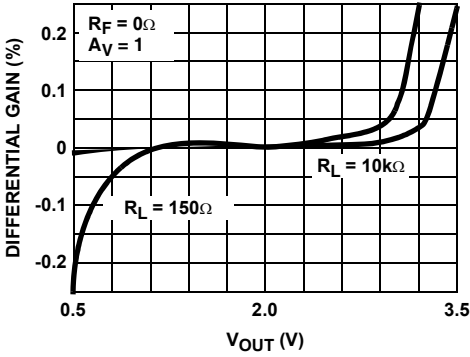

FIGURE 27. DIFFERENTIAL GAIN FOR R_L TIED TO 2.5V

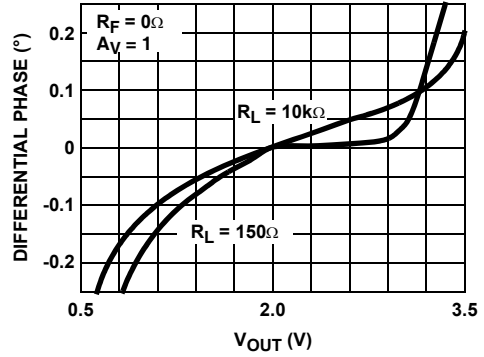

FIGURE 28. DIFFERENTIAL PHASE FOR R_L TIED TO 2.5V

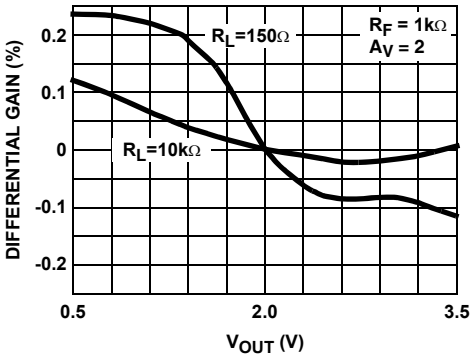

FIGURE 29. DIFFERENTIAL GAIN FOR R_L TIED TO 0V

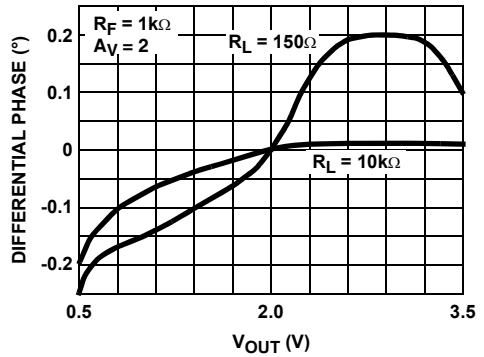

FIGURE 30. DIFFERENTIAL PHASE FOR R_L TIED TO 0V

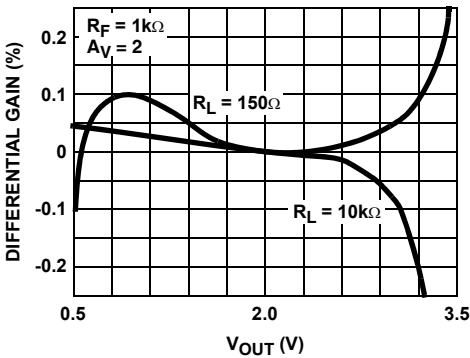

FIGURE 31. DIFFERENTIAL GAIN FOR R_L TIED TO 2.5V

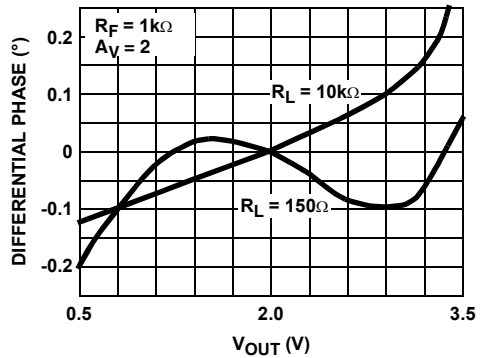

FIGURE 32. DIFFERENTIAL PHASE FOR R_L TIED TO 2.5V

Typical Performance Curves

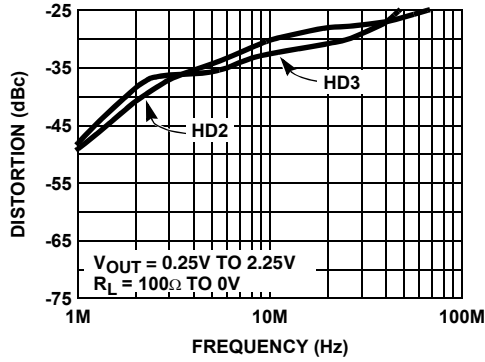

FIGURE 33. 2nd AND 3rd HARMONIC DISTORTION vs FREQUENCY

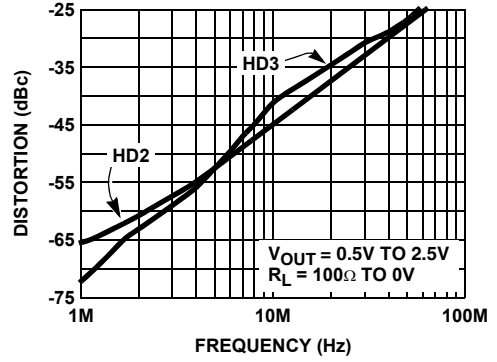

FIGURE 34. 2nd AND 3rd HARMONIC DISTORTION vs FREQUENCY

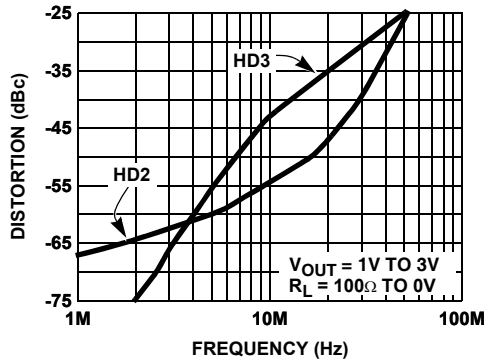

FIGURE 35. 2nd AND 3rd HARMONIC DISTORTION vs FREQUENCY

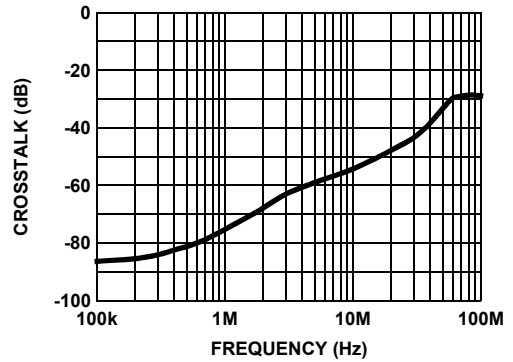

FIGURE 36. CHANNEL-TO-CHANNEL CROSSTALK - DUALS AND QUADS (WORST CHANNEL)

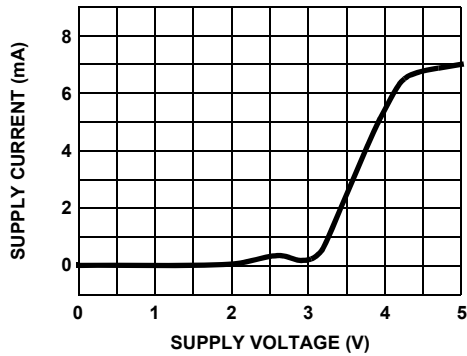

FIGURE 37. SUPPLY CURRENT (PER AMP) vs SUPPLY VOLTAGE

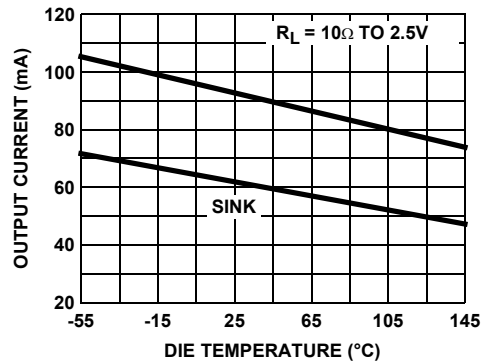

FIGURE 38. OUTPUT CURRENT VS DIE TEMPERATURE

Typical Performance Curves

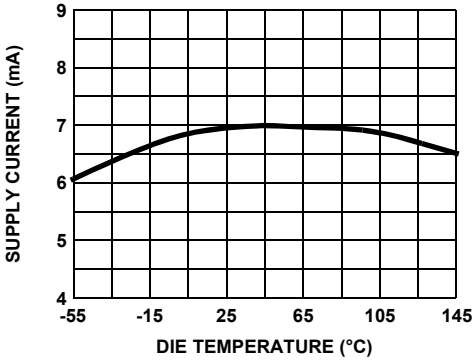

FIGURE 39. SUPPLY CURRENT - ON (PER AMP) vs DIE TEMPERATURE

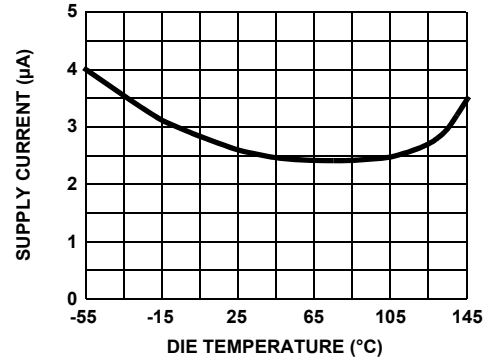

FIGURE 40. SUPPLY CURRENT - OFF (PER AMP) vs DIE TEMPERATURE

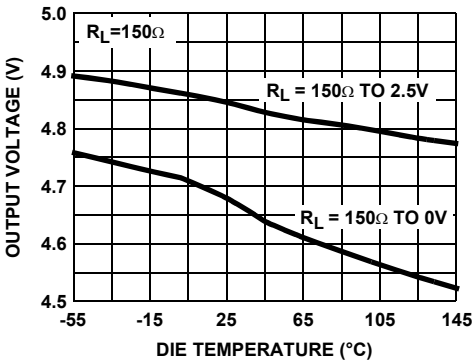

FIGURE 41. POSITIVE OUTPUT VOLTAGE SWING vs DIE TEMPERATURE

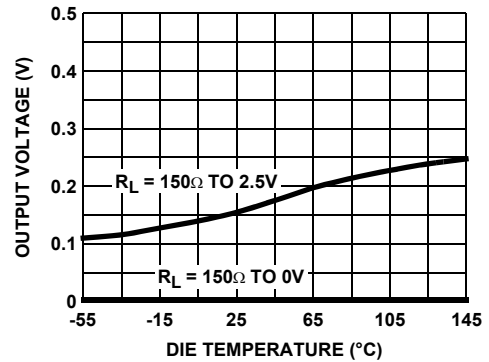

FIGURE 42. NEGATIVE OUTPUT VOLTAGE SWING vs DIE TEMPERATURE

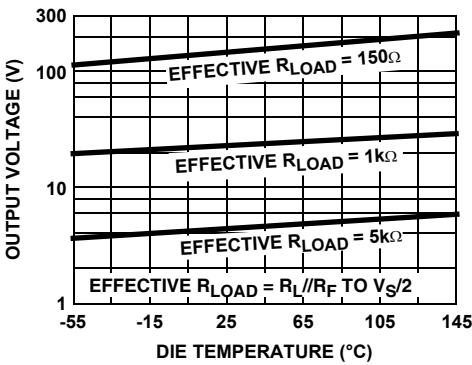

FIGURE 43. OUTPUT VOLTAGE FROM EITHER RAIL vs DIE TEMPERATURE FOR VARIOUS EFFECTIVE RLOAD

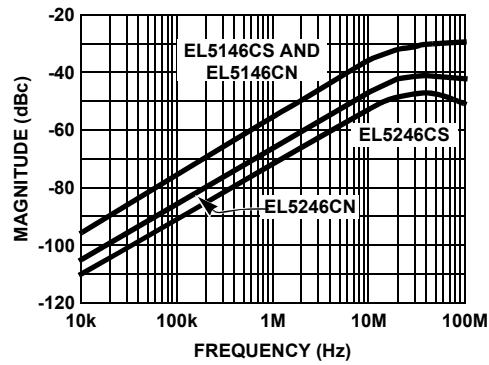

FIGURE 44. OFF ISOLATION - EL5146 AND EL5246

Typical Performance Curves

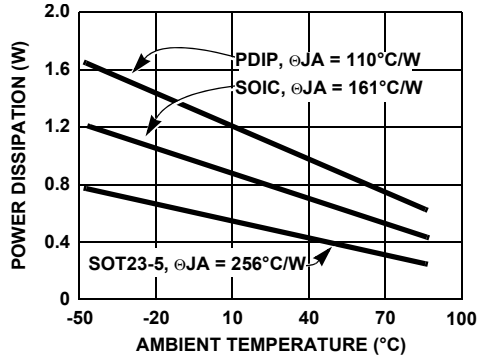

FIGURE 45. MAXIMUM POWER DISSIPATION vs AMBIENT TEMPERATURE SINGLES ($T_{JMAX} = +150^{\circ}\text{C}$)

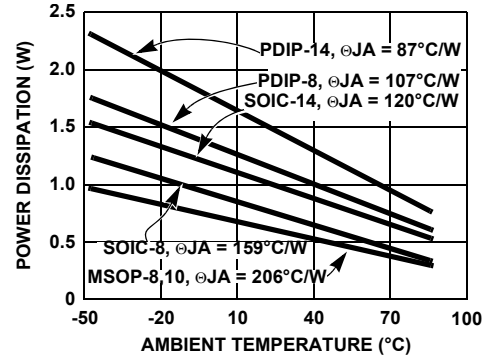

FIGURE 46. MAXIMUM POWER DISSIPATION vs AMBIENT TEMPERATURE DUALS ($T_{JMAX} = +150^{\circ}\text{C}$)

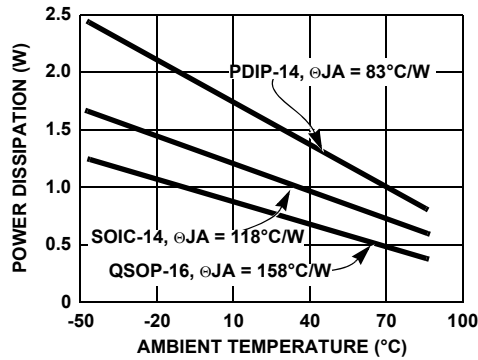

FIGURE 47. MAXIMUM POWER DISSIPATION vs AMBIENT TEMPERATURE QUADS ($T_{JMAX} = +150^{\circ}\text{C}$)

Pin Descriptions

EL5144 5 Ld SOT23	EL5146 8 Ld SO/PDIP	EL5244 8 Ld SO/ PDIP/MSOP	EL5246 10 Ld MSOP	EL5246 14 Ld SO/PDIP	EL5444 14 Ld SO/PDIP	EL5444 16 Ld QSOP	NAME	FUNCTION	EQUIVALENT CIRCUIT
5	7	8	8	11	4	4, 5	VS	Positive Power Supply	
2	4	4	3	4	11	12, 13	GND	Ground or Negative Power Supply	
3	3						IN+	Non-inverting Input	<p>Circuit 1</p>
4	2						IN-	Inverting Input	(Reference Circuit 1)
1	6						OUT	Amplifier Output	<p>Circuit 2</p>
		3	1	1	3	3	INA+	Amplifier A Non-inverting Input	(Reference Circuit 1)
		2	10	14	2	2	INA-	Amplifier A Inverting Input	(Reference Circuit 1)
		1	9	13	1	1	OUTA	Amplifier A Output	(Reference Circuit 2)
		5	5	7	5	6	INB+	Amplifier B Non-inverting Input	(Reference Circuit 1)
		6	6	8	6	7	INB-	Amplifier B Inverting Input	(Reference Circuit 1)
		7	7	9	7	8	OUTB	Amplifier B Output	(Reference Circuit 2)
					10	11	INC+	Amplifier C Non-inverting Input	(Reference Circuit 1)
					9	10	INC-	Amplifier C Inverting Input	(Reference Circuit 1)
					8	9	OUTC	Amplifier C Output	(Reference Circuit 2)
					12	14	IND+	Amplifier D Non-inverting Input	(Reference Circuit 1)
					13	15	IND-	Amplifier D Inverting Input	(Reference Circuit 1)
					14	16	OUTD	Amplifier D Output	(Reference Circuit 2)
	8						CE	Enable (Enabled when high)	<p>Circuit 3</p>

Pin Descriptions (Continued)

EL5144 5 Ld SOT23	EL5146 8 Ld SO/PDIP	EL5244 8 Ld SO/ PDIP/MSOP	EL5246 10 Ld MSOP	EL5246 14 Ld SO/PDIP	EL5444 14 Ld SO/PDIP	EL5444 16 Ld QSOP	NAME	FUNCTION	EQUIVALENT CIRCUIT
			2	3			CEA	Enable Amplifier A (Enabled when high)	(Reference Circuit 3)
			4	5			CEB	Enable Amplifier B (Enabled when high)	(Reference Circuit 3)
	1, 5			2, 6, 10, 12			NC	No Connect. Not internally connected.	

Description of Operation and Applications Information

Product Description

The EL5144 series is a family of wide bandwidth, single supply, low power, rail-to-rail output, voltage feedback operational amplifiers. The family includes single, dual, and quad configurations. The singles and duals are available with a power-down pin to reduce power to 2.6µA typically. All the amplifiers are internally compensated for closed loop feedback gains of +1 or greater. Larger gains are acceptable but bandwidth will be reduced according to the familiar Gain Bandwidth Product.

Connected in voltage follower mode and driving a high impedance load, the EL5144 series has a -3dB bandwidth of 100MHz. Driving a 150Ω load, they have a -3dB bandwidth of 60MHz while maintaining a 200V/µs slew rate. The input common mode voltage range includes ground while the output can swing rail-to-rail.

Power Supply Bypassing and Printed Circuit Board Layout

As with any high-frequency device, good printed circuit board layout is necessary for optimum performance. Ground plane construction is highly recommended. Lead lengths should be as short as possible. The power supply pin must be well bypassed to reduce the risk of oscillation. For normal single supply operation, where the GND pin is connected to the ground plane, a single 4.7µF tantalum capacitor in parallel with a 0.1µF ceramic capacitor from V_S to GND will suffice. This same capacitor combination should be placed at each supply pin to ground if split supplies are to be used. In this case, the GND pin becomes the negative supply rail.

For good AC performance, parasitic capacitance should be kept to a minimum. Use of wire wound resistors should be avoided because of their additional series inductance. Use of sockets, particularly for the SO package, should be avoided if possible. Sockets add parasitic inductance and capacitance that can result in compromised performance.

Input, Output and Supply Voltage Range

The EL5144 series has been designed to operate with a single supply voltage of 5V. Split supplies can be used so long as their total range is 5V.

The amplifiers have an input common mode voltage range that includes the negative supply (GND pin) and extends to within 1.5V of the positive supply (V_S pin). They are specified over this range.

The output of the EL5144 series amplifiers can swing rail to rail. As the load resistance becomes lower in value, the ability to drive close to each rail is reduced. However, even with an effective 150Ω load resistor connected to a voltage halfway between the supply rails, the output will swing to within 150mV of either rail.

Figure 48 shows the output of the EL5144 series amplifier swinging rail to rail with R_F = 1kΩ, A_V = +2 and R_L = 1MΩ. Figure 49 is with R_L = 150Ω.

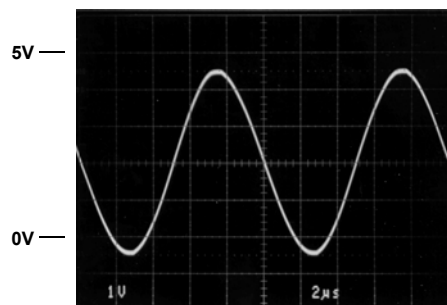

FIGURE 48.

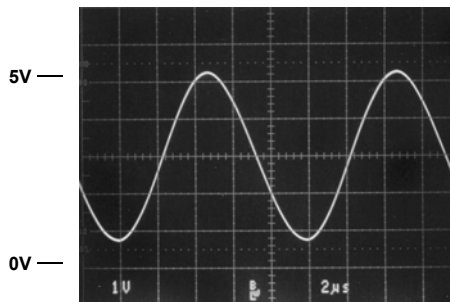

FIGURE 49.

Choice of Feedback Resistor, R_F

These amplifiers are optimized for applications that require a gain of +1. Hence, no feedback resistor is required.

However, for gains greater than +1, the feedback resistor forms a pole with the input capacitance. As this pole becomes larger, phase margin is reduced. This causes ringing in the time domain and peaking in the frequency domain. Therefore, R_F has some maximum value that should not be exceeded for optimum performance. If a large value of R_F must be used, a small capacitor in the few picofarad range in parallel with R_F can help to reduce this ringing and peaking at the expense of reducing the bandwidth.

As far as the output stage of the amplifier is concerned, $R_F + R_G$ appear in parallel with R_L for gains other than +1. As this combination gets smaller, the bandwidth falls off.

Consequently, R_F also has a minimum value that should not be exceeded for optimum performance.

For $A_V = +1$, $R_F = 0\Omega$ is optimum. For $A_V = -1$ or +2 (noise gain of 2), optimum response is obtained with R_F between 300Ω and $1k\Omega$. For $A_V = -4$ or +5 (noise gain of 5), keep R_F between 300Ω and $15k\Omega$.

Video Performance

For good video signal integrity, an amplifier is required to maintain the same output impedance and the same frequency response as DC levels are changed at the output. This can be difficult when driving a standard video load of 150Ω , because of the change in output current with DC level. A look at Figures 25 through 32 beginning on page 10 (Differential Gain and Differential Phase curves for various supply and loading conditions) will help you obtain optimal performance. Curves are provided for $A_V = +1$ and +2, and $R_L = 150\Omega$ and $10k\Omega$ tied both to ground as well as 2.5V. As with all video amplifiers, there is a common mode sweet spot for optimum differential gain/differential phase. For example, with $A_V = +2$ and $R_L = 150\Omega$ tied to 2.5V, and the output common mode voltage kept between 0.8V and 3.2V, dG/dP is a very low 0.1%/0.1°. This condition corresponds to driving an AC-coupled, double terminated 75Ω coaxial cable. With $A_V = +1$, $R_L = 150\Omega$ tied to ground, and the video level kept between 0.85V and 2.95V, these amplifiers provide dG/dP performance of 0.05%/0.20°. This condition is representative of using the EL5144 series amplifier as a buffer driving a DC coupled, double terminated, 75Ω coaxial cable. Driving high impedance loads, such as signals on computer video cards, gives similar or better dG/dP performance as driving cables.

Driving Cables and Capacitive Loads

The EL5144 series amplifiers can drive 50pF loads in parallel with 150Ω with 4dB of peaking and 100pF with 7dB of peaking. If less peaking is desired in these applications, a small series resistor (usually between 5Ω and 50Ω) can be placed in series with the output to eliminate most peaking.

However, this will obviously reduce the gain slightly. If your gain is greater than 1, the gain resistor (R_G) can then be chosen to make up for any gain loss, which may be created by this additional resistor at the output. Another method of reducing peaking is to add a “snubber” circuit at the output. A snubber is a resistor in a series with a capacitor, 150Ω and $100pF$ being typical values. The advantage of a snubber is that it does not draw DC load current.

When used as a cable driver, double termination is always recommended for reflection-free performance. For those applications, the back-termination series resistor will de-couple the EL5144 series amplifier from the cable and allow extensive capacitive drive. However, other applications may have high capacitive loads without a back-termination resistor. Again, a small series resistor at the output can reduce peaking.

Disable/Power-Down

The EL5146 and EL5246 amplifiers can be disabled, placing its output in a high-impedance state. Turn-off time is only 10ns and turn-on time is around 500ns. When disabled, the amplifier's supply current is reduced to $2.6\mu A$ typically, thereby effectively eliminating power consumption. The amplifier's power-down can be controlled by standard TTL or CMOS signal levels at the CE pin. The applied logic signal is relative to the GND pin. Letting the CE pin float will enable the amplifier. Hence, the 8 Ld PDIP and 8 Ld SOIC single amps are pin compatible with standard amplifiers that don't have a power-down feature.

Short Circuit Current Limit

The EL5144 series amplifiers do not have internal short circuit protection circuitry. Short circuit current of 90mA sourcing and 65mA sinking typically will flow if the output is trying to drive high or low but is shorted to half way between the rails. If an output is shorted indefinitely, the power dissipation could easily increase such that the part will be destroyed. Maximum reliability is maintained if the output current never exceeds $\pm 50mA$. This limit is set by internal metal interconnect limitations. Obviously, short circuit conditions must not remain or the internal metal connections will be destroyed.

Power Dissipation

With the high output drive capability of the EL5144 series amplifiers, it is possible to exceed the $+150^\circ C$ Absolute Maximum junction temperature under certain load current conditions. Therefore, it is important to calculate the maximum junction temperature for the application to determine if load conditions or package type need to be modified for the amplifier to remain in the safe operating area.

The maximum power dissipation allowed in a package is determined according to Equation 1:

$$PD_{MAX} = \frac{T_{JMAX} - T_{AMAX}}{\theta_{JA}} \quad (EQ. 1)$$

where:

T_{JMAX} = Maximum junction temperature

T_{AMAX} = Maximum ambient temperature

θ_{JA} = Thermal resistance of the package

PD_{MAX} = Maximum power dissipation in the package

The maximum power dissipation actually produced by an IC is the total quiescent supply current times the total power supply voltage, plus the power in the IC due to the load, or as expressed in Equation 2:

$$D_{MAX} = N \times \left[V_S \times I_{SMAX} + (V_S - V_{OUT}) \times \frac{V_{OUT}}{R_L} \right] \quad (EQ. 2)$$

where:

N = Number of amplifiers in the package

V_S = Total supply voltage

I_{SMAX} = Maximum supply current per amplifier

V_{OUT} = Maximum output voltage of the application

R_L = Load resistance tied to ground

If we set the two PD_{MAX} equations equal to each other, we can solve for R_L using Equation 3:

$$R_L = \frac{V_{OUT} \times (V_S - V_{OUT})}{\left(\frac{T_{JMAX} - T_{AMAX}}{N \times \theta_{JA}} \right) - (V_S \times I_{SMAX})} \quad (EQ. 3)$$

Assuming worst case conditions of $T_A = +85^\circ\text{C}$, $V_{OUT} = V_S/2V$, $V_S = 5.5V$, and $I_{SMAX} = 8.8\text{mA}$ per amplifier, following is a table of all packages and the minimum R_L allowed.

PART	PACKAGE	MINIMUM R_L
EL5144CW	SOT23-5	37
EL5146CS	SOIC-8	21
EL5146CN	PDIP-8	14
EL5244CS	SOIC-8	48
EL5244CN	PDIP-8	30
EL5244CY	MSOP-8	69
EL5246CY	MSOP-10	69
EL5246CS	SOIC-14	34
EL5246CN	PDIP-14	23
EL5444CU	QSOP-16	139
EL5444CS	SOIC-14	85
EL5444CN	PDIP-14	51

EL5144 Series Comparator Application

The EL5144 series amplifier can be used as a very fast, single supply comparator. Most op amps used as a comparator allow only slow speed operation because of output saturation issues. The EL5144 series amplifier doesn't suffer from output saturation issues. Figure 50 shows the amplifier implemented as a comparator. Figure 51 is a graph of propagation delay vs overdrive as a square wave is presented at the input of the comparator.

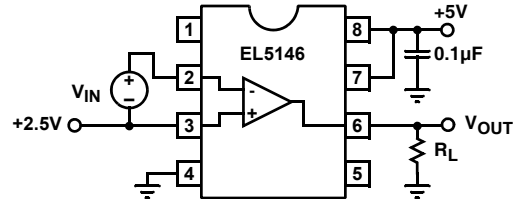

FIGURE 50. EL5146 AMPLIFIER IMPLEMENTED AS A COMPARATOR

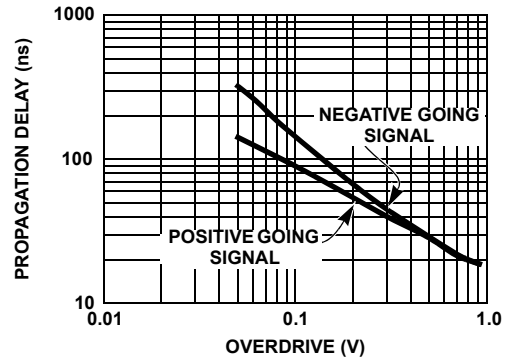

FIGURE 51. PROPAGATION DELAY vs OVERDRIVE FOR AMPLIFIER USED AS A COMPARATOR

Multiplexing with the EL5144 Series Amplifier

Besides normal power-down usage, the CE pin on the EL5146 and EL5246 series amplifiers also allow for multiplexing applications. Figure 52 shows an EL5246 with its outputs tied together, driving a back terminated 75Ω video load. A 3V_{p-p} 10MHz sine wave is applied at Amp A input, and a 2.4V_{p-p} 5MHz square wave to Amp B. Figure 53 shows the SELECT signal that is applied, and the resulting output waveform at V_{OUT} . Observe the break-before-make operation of the multiplexing. Amp A is on and V_{IN1} is being passed through to the output of the amplifier. Then Amp A turns off in about 10ns. The output decays to ground with an $R_L C_L$ time constants. 500ns later, Amp B turns on and V_{IN2} is passed through to the output. This break-before-make operation ensures that more than one amplifier isn't trying to drive the bus at the same time. Notice the outputs are tied directly together. Isolation resistors at each output are not necessary.

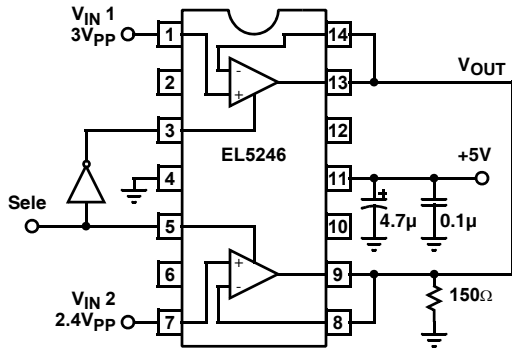

FIGURE 52.

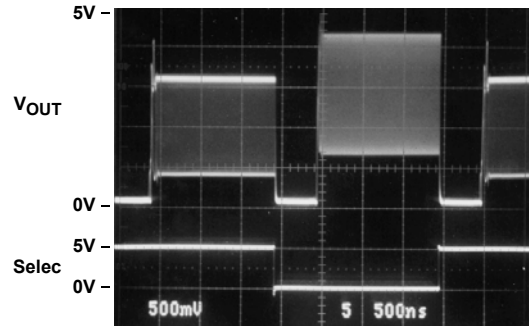

FIGURE 53.

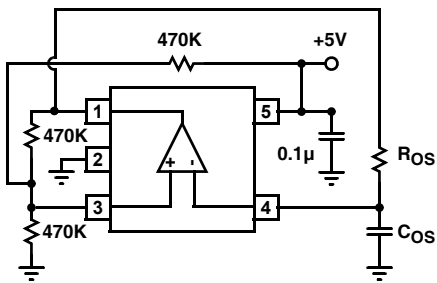

FIGURE 54.

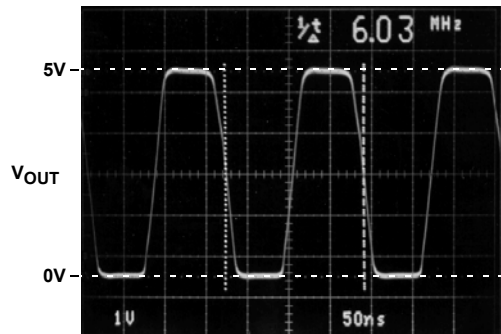

FIGURE 55.

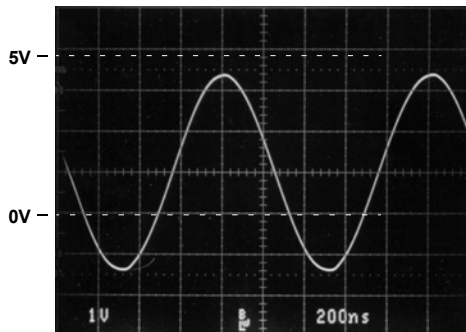

FIGURE 56.

Free Running Oscillator Application

Figure 54 is an EL5144 configured as a free running oscillator. To first order, R_{OSC} and C_{OSC} determine the frequency of oscillation according to:

$$F_{OSC} = \frac{0.72}{R_{OSC} \times C_{OSC}} \quad (EQ. 4)$$

For rail to rail output swings, maximum frequency of oscillation is around 15MHz. If reduced output swings are acceptable, 25MHz can be achieved. Figure 55 shows the oscillator for $R_{OSC} = 510\Omega$, $C_{OSC} = 240pF$ and $F_{OSC} = 6MHz$.

SOT-23 Package Family

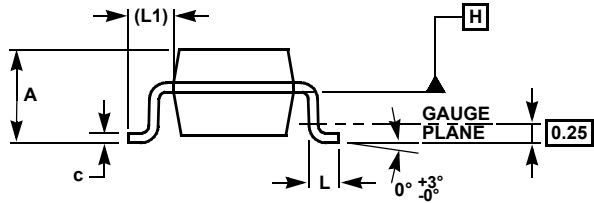
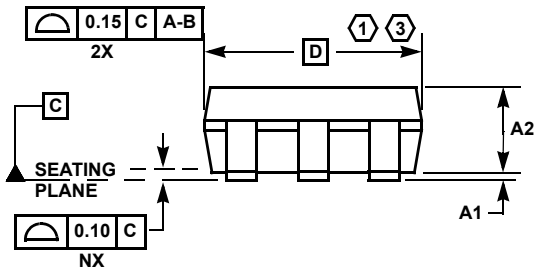
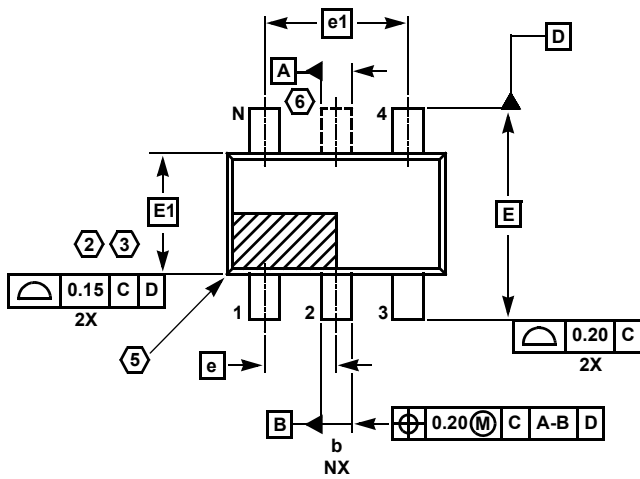

MDP0038

SOT-23 PACKAGE FAMILY

SYMBOL	SOT23-5	SOT23-6	TOLERANCE
A	1.45	1.45	MAX
A1	0.10	0.10	±0.05
A2	1.14	1.14	±0.15
b	0.40	0.40	±0.05
c	0.14	0.14	±0.06
D	2.90	2.90	Basic
E	2.80	2.80	Basic
E1	1.60	1.60	Basic
e	0.95	0.95	Basic
e1	1.90	1.90	Basic
L	0.45	0.45	±0.10
L1	0.60	0.60	Reference
N	5	6	Reference

Rev. E 3/00

NOTES:

1. Plastic or metal protrusions of 0.25mm maximum per side are not included.
2. Plastic interlead protrusions of 0.25mm maximum per side are not included.
3. This dimension is measured at Datum Plane "H".
4. Dimensioning and tolerancing per ASME Y14.5M-1994.
5. Index area - Pin #1 I.D. will be located within the indicated zone (SOT23-6 only).
6. SOT23-5 version has no center lead (shown as a dashed line).

Small Outline Package Family (SO)

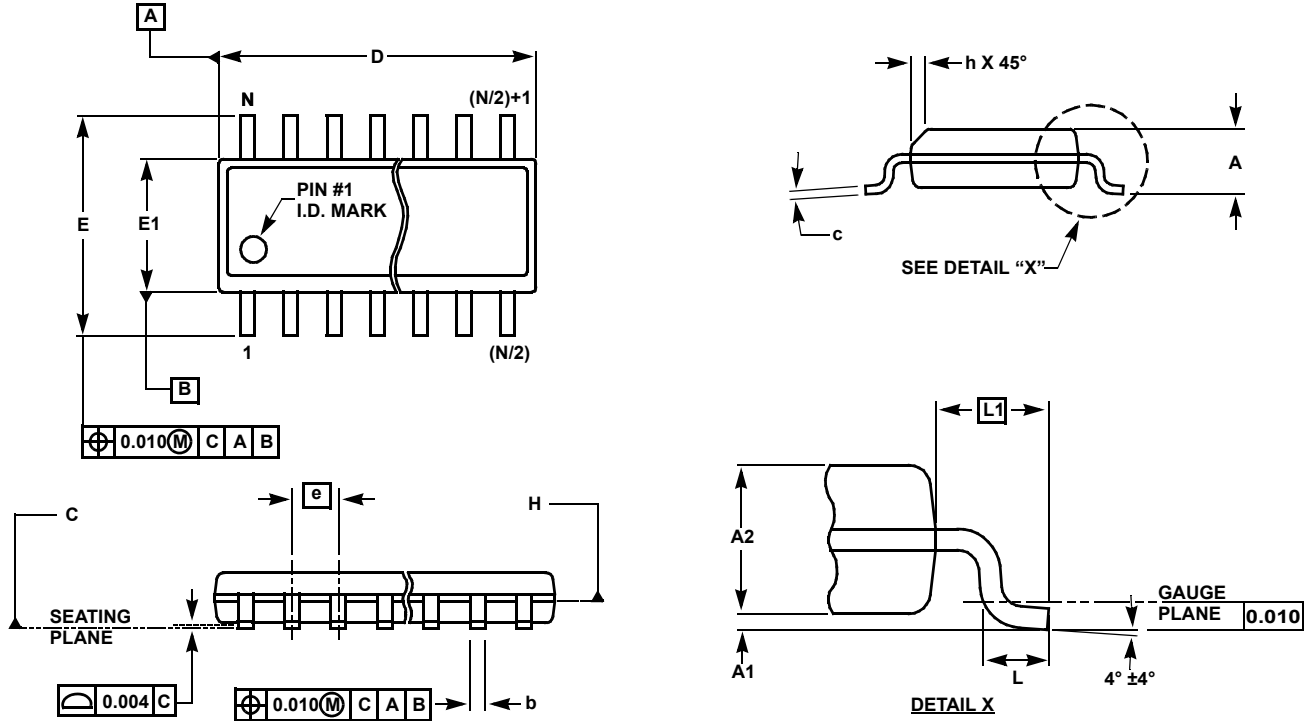

MDP0027

SMALL OUTLINE PACKAGE FAMILY (SO)

SYMBOL	INCHES							TOLERANCE	NOTES
	SO-8	SO-14	SO16 (0.150")	SO16 (0.300") (SOL-16)	SO20 (SOL-20)	SO24 (SOL-24)	SO28 (SOL-28)		
A	0.068	0.068	0.068	0.104	0.104	0.104	0.104	MAX	-
A1	0.006	0.006	0.006	0.007	0.007	0.007	0.007	±0.003	-
A2	0.057	0.057	0.057	0.092	0.092	0.092	0.092	±0.002	-
b	0.017	0.017	0.017	0.017	0.017	0.017	0.017	±0.003	-
c	0.009	0.009	0.009	0.011	0.011	0.011	0.011	±0.001	-
D	0.193	0.341	0.390	0.406	0.504	0.606	0.704	±0.004	1, 3
E	0.236	0.236	0.236	0.406	0.406	0.406	0.406	±0.008	-
E1	0.154	0.154	0.154	0.295	0.295	0.295	0.295	±0.004	2, 3
e	0.050	0.050	0.050	0.050	0.050	0.050	0.050	Basic	-
L	0.025	0.025	0.025	0.030	0.030	0.030	0.030	±0.009	-
L1	0.041	0.041	0.041	0.056	0.056	0.056	0.056	Basic	-
h	0.013	0.013	0.013	0.020	0.020	0.020	0.020	Reference	-
N	8	14	16	16	20	24	28	Reference	-

Rev. M 2/07

NOTES:

1. Plastic or metal protrusions of 0.006" maximum per side are not included.
2. Plastic interlead protrusions of 0.010" maximum per side are not included.
3. Dimensions "D" and "E1" are measured at Datum Plane "H".
4. Dimensioning and tolerancing per ASME Y14.5M-1994

Plastic Dual-In-Line Packages (PDIP)

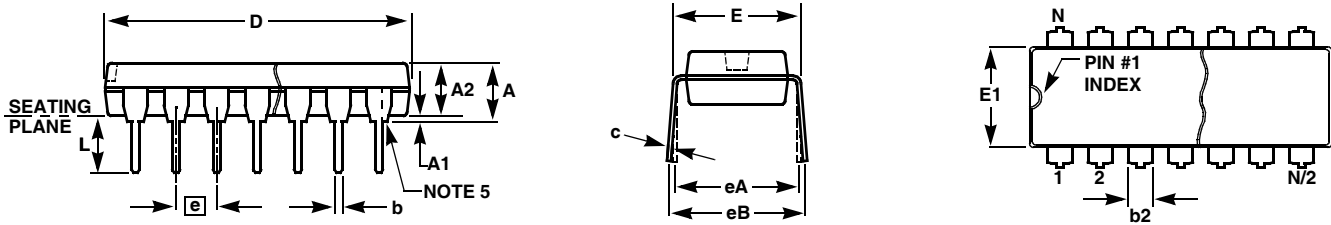

MDP0031

PLASTIC DUAL-IN-LINE PACKAGE

SYMBOL	INCHES					TOLERANCE	NOTES
	PDIP8	PDIP14	PDIP16	PDIP18	PDIP20		
A	0.210	0.210	0.210	0.210	0.210	MAX	
A1	0.015	0.015	0.015	0.015	0.015	MIN	
A2	0.130	0.130	0.130	0.130	0.130	±0.005	
b	0.018	0.018	0.018	0.018	0.018	±0.002	
b2	0.060	0.060	0.060	0.060	0.060	+0.010/-0.015	
c	0.010	0.010	0.010	0.010	0.010	+0.004/-0.002	
D	0.375	0.750	0.750	0.890	1.020	±0.010	1
E	0.310	0.310	0.310	0.310	0.310	+0.015/-0.010	
E1	0.250	0.250	0.250	0.250	0.250	±0.005	2
e	0.100	0.100	0.100	0.100	0.100	Basic	
eA	0.300	0.300	0.300	0.300	0.300	Basic	
eB	0.345	0.345	0.345	0.345	0.345	±0.025	
L	0.125	0.125	0.125	0.125	0.125	±0.010	
N	8	14	16	18	20	Reference	

Rev. C 2/07

NOTES:

1. Plastic or metal protrusions of 0.010" maximum per side are not included.
2. Plastic interlead protrusions of 0.010" maximum per side are not included.
3. Dimensions E and eA are measured with the leads constrained perpendicular to the seating plane.
4. Dimension eB is measured with the lead tips unconstrained.
5. 8 and 16 lead packages have half end-leads as shown.

Mini SO Package Family (MSOP)

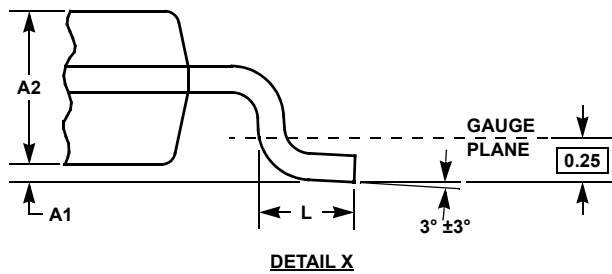
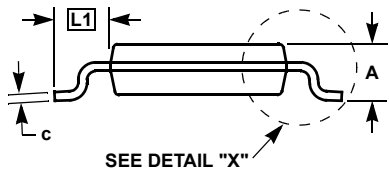
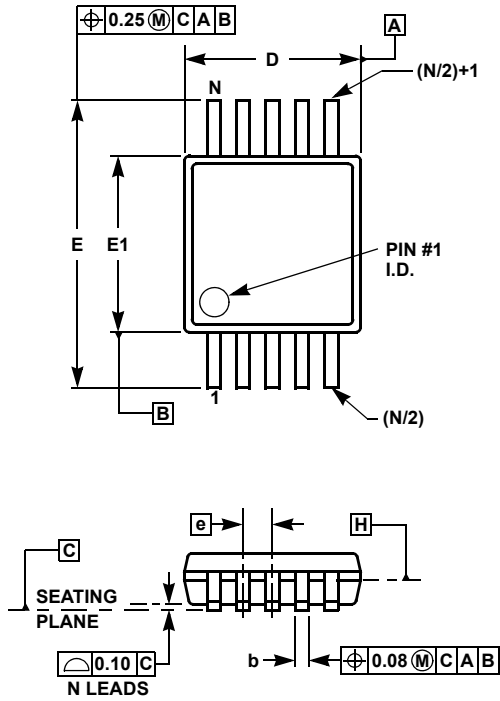

MDP0043
MINI SO PACKAGE FAMILY

SYMBOL	MILLIMETERS		TOLERANCE	NOTES
	MSOP8	MSOP10		
A	1.10	1.10	Max.	-
A1	0.10	0.10	±0.05	-
A2	0.86	0.86	±0.09	-
b	0.33	0.23	+0.07/-0.08	-
c	0.18	0.18	±0.05	-
D	3.00	3.00	±0.10	1, 3
E	4.90	4.90	±0.15	-
E1	3.00	3.00	±0.10	2, 3
e	0.65	0.50	Basic	-
L	0.55	0.55	±0.15	-
L1	0.95	0.95	Basic	-
N	8	10	Reference	-

Rev. D 2/07

NOTES:

1. Plastic or metal protrusions of 0.15mm maximum per side are not included.
2. Plastic interlead protrusions of 0.25mm maximum per side are not included.
3. Dimensions "D" and "E1" are measured at Datum Plane "H".
4. Dimensioning and tolerancing per ASME Y14.5M-1994.

Quarter Size Outline Plastic Packages Family (QSOP)

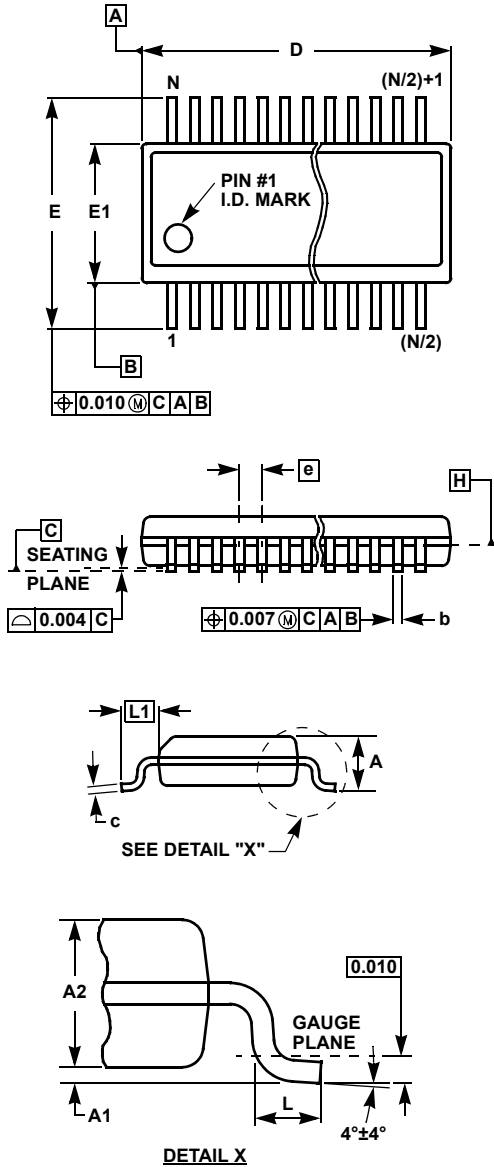

MDP0040

QUARTER SIZE OUTLINE PLASTIC PACKAGES FAMILY

SYMBOL	INCHES			TOLERANCE	NOTES
	QSOP16	QSOP24	QSOP28		
A	0.068	0.068	0.068	Max.	-
A1	0.006	0.006	0.006	± 0.002	-
A2	0.056	0.056	0.056	± 0.004	-
b	0.010	0.010	0.010	± 0.002	-
c	0.008	0.008	0.008	± 0.001	-
D	0.193	0.341	0.390	± 0.004	1, 3
E	0.236	0.236	0.236	± 0.008	-
E1	0.154	0.154	0.154	± 0.004	2, 3
e	0.025	0.025	0.025	Basic	-
L	0.025	0.025	0.025	± 0.009	-
L1	0.041	0.041	0.041	Basic	-
N	16	24	28	Reference	-

Rev. F 2/07

NOTES:

1. Plastic or metal protrusions of 0.006" maximum per side are not included.
2. Plastic interlead protrusions of 0.010" maximum per side are not included.
3. Dimensions "D" and "E1" are measured at Datum Plane "H".
4. Dimensioning and tolerancing per ASME Y14.5M-1994.

All Intersil U.S. products are manufactured, assembled and tested utilizing ISO9000 quality systems. Intersil Corporation's quality certifications can be viewed at www.intersil.com/design/quality

Intersil products are sold by description only. Intersil Corporation reserves the right to make changes in circuit design, software and/or specifications at any time without notice. Accordingly, the reader is cautioned to verify that data sheets are current before placing orders. Information furnished by Intersil is believed to be accurate and reliable. However, no responsibility is assumed by Intersil or its subsidiaries for its use; nor for any infringements of patents or other rights of third parties which may result from its use. No license is granted by implication or otherwise under any patent or patent rights of Intersil or its subsidiaries.

For information regarding Intersil Corporation and its products, see www.intersil.com