



Chipsmall Limited consists of a professional team with an average of over 10 year of expertise in the distribution of electronic components. Based in Hongkong, we have already established firm and mutual-benefit business relationships with customers from,Europe,America and south Asia,supplying obsolete and hard-to-find components to meet their specific needs.

With the principle of “Quality Parts,Customers Priority,Honest Operation,and Considerate Service”,our business mainly focus on the distribution of electronic components. Line cards we deal with include Microchip,ALPS,ROHM,Xilinx,Pulse,ON,Everlight and Freescale. Main products comprise IC,Modules,Potentiometer,IC Socket,Relay,Connector.Our parts cover such applications as commercial,industrial, and automotives areas.

We are looking forward to setting up business relationship with you and hope to provide you with the best service and solution. Let us make a better world for our industry!



Contact us

Tel: +86-755-8981 8866 Fax: +86-755-8427 6832

Email & Skype: info@chipsmall.com Web: www.chipsmall.com

Address: A1208, Overseas Decoration Building, #122 Zhenhua RD., Futian, Shenzhen, China



4 PIN SOP RANDOM-PHASE TRIAC PHOTOCOUPLER ELM302X, ELM305X Series

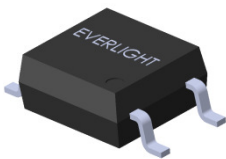

Schematic

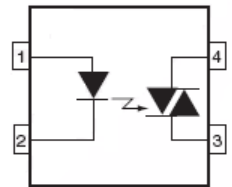

Pin Configuration

1. Anode
2. Cathode
3. Terminal
4. Terminal

Features:

- Peak breakdown voltage
 - 400V: ELM302X
 - 600V: ELM305X
- High isolation voltage between input and output (Viso=3750 V rms)
- Compact dual-in-line package
- Pb free and RoHS compliant.
- UL approved (No. E214129)
- VDE approved (No.132249)
- SEMKO approved
- NEMKO approved
- DEMKO approved
- FIMKO approved

Description

The ELM302X series and ELM305X series are optically isolated triac driver devices. These devices contain a GaAs infrared emitting diode and a light activated silicon bilateral switch, which functions like a triac.

They are designed for interfacing between electronic controls and power triacs to control resistive and inductive loads for 115 to 240 VAC operations.

Applications

- Solenoid/valve controls
- Lamp ballasts
- Static AC power switch
- Interfacing microprocessors to 115 to 240Vac peripherals
- Incandescent lamp dimmers
- Temperature controls
- Motor controls

Absolute Maximum Ratings (Ta=25°C)

Parameter		Symbol	Rating	Unit
Input	Forward current	I_F	60	mA
	Reverse voltage	V_R	6	V
	Power Dissipation	P_D	100	mW
Output	Off-state Output Terminal Voltage	V_{DRM}	ELM302X 400	V
			ELM305X 600	
	On state RMS current	$I_{T(RMS)}$	70	mA(RMS)
	Peak Repetitive Surge Current	I_{TSM}	1	A
	Power dissipation	P_C	300	mW
Total power dissipation		P_{TOT}	200	mW
Isolation voltage ^{*1}		V_{ISO}	3750	Vrms
Operating temperature		T_{OPR}	-40~+110	°C
Storage temperature		T_{STG}	-55~+150	°C
Soldering Temperature ^{*2}		T_{SOL}	260	°C

Notes:

*1 AC for 1 minute, R.H.= 40 ~ 60% R.H. In this test, pins 1, 2 are shorted together, and pins 3, 4 are shorted together.

*2 For 10 seconds

Electro-Optical Characteristics (Ta=25°C unless specified otherwise)

Input

Parameter	Symbol	Min.	Typ.*	Max.	Unit	Condition
Forward Voltage	V _F	-	1.2	1.5	V	I _F = 10mA
Reverse Leakage current	I _R	-	-	10	μA	V _R = 6V

Output

Parameter	Symbol	Min.	Typ.*	Max.	Unit	Condition
Peak Blocking Current	I _{DRM}	-	-	100	nA	V _{DRM} = Rated V _{DRM} I _F = 0mA
Peak On-state Voltage	V _{TM}	-	-	2.5	V	I _{TM} =100mA peak, I _F =Rated I _{FT}
Critical Rate of Rise off-state Voltage	ELM302X	-	10	-	V/μs	IF=0mA, Figure 8
	ELM305X	1000	-	-		

Transfer Characteristics

Parameter	Symbol	Min.	Typ.*	Max.	Unit	Condition
LED Trigger Current	3022 3052	-	-	10	mA	Main terminal Voltage=3V
	3023 3053	-	-	5		
	3024 3054	-	-	3		
Holding Current	I _H	-	3	5	mA	
Turn-on time	T _{on}	-	-	100	μS	V _D =6V, R _L =100ohm, I _F =20mA

* Typical values at T_a = 25°C

Typical Electro-Optical Characteristics Curves

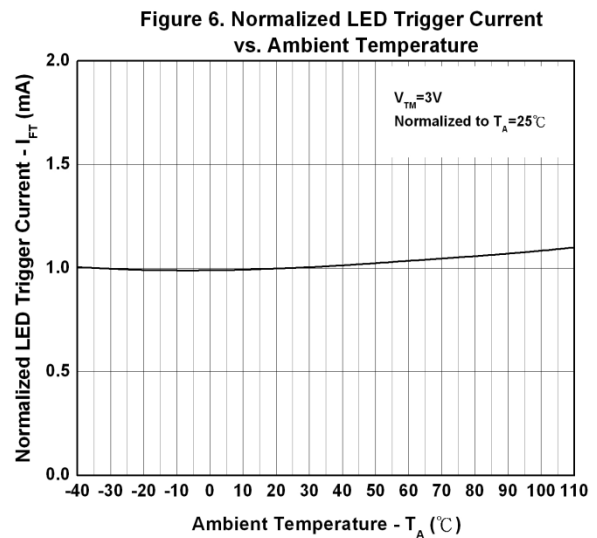
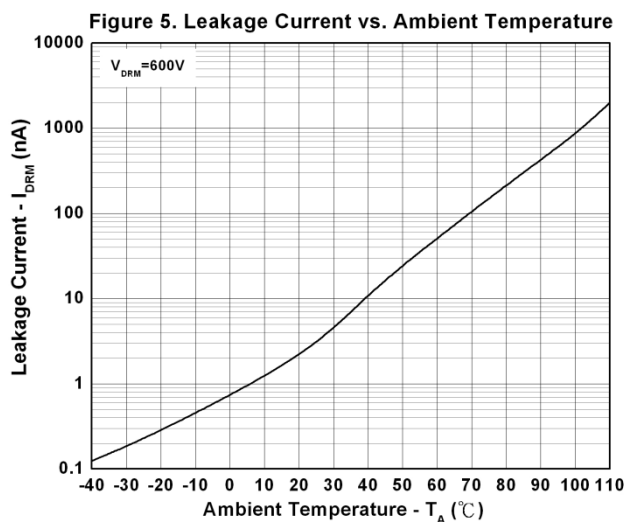
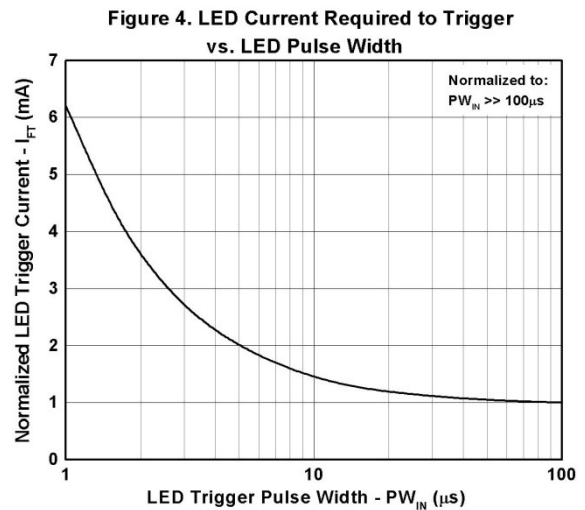
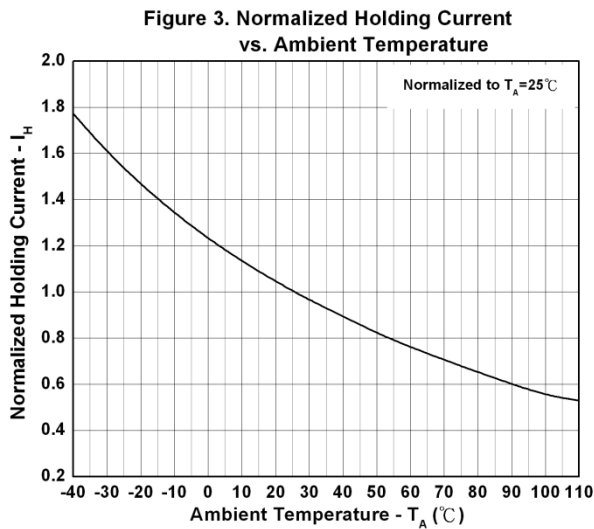
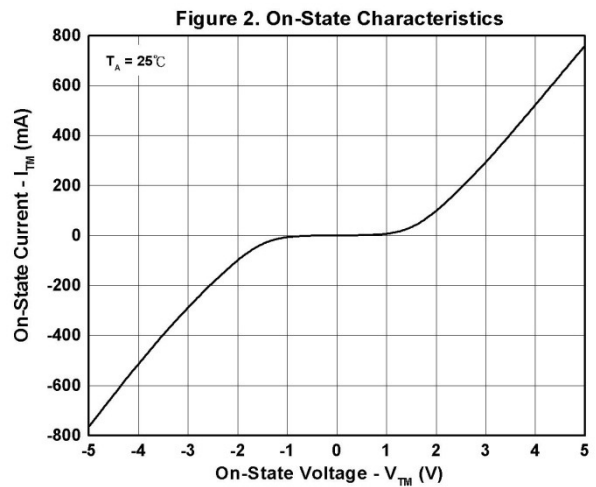
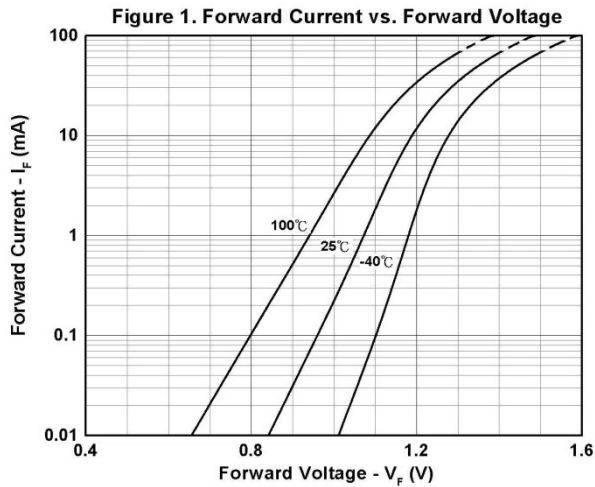

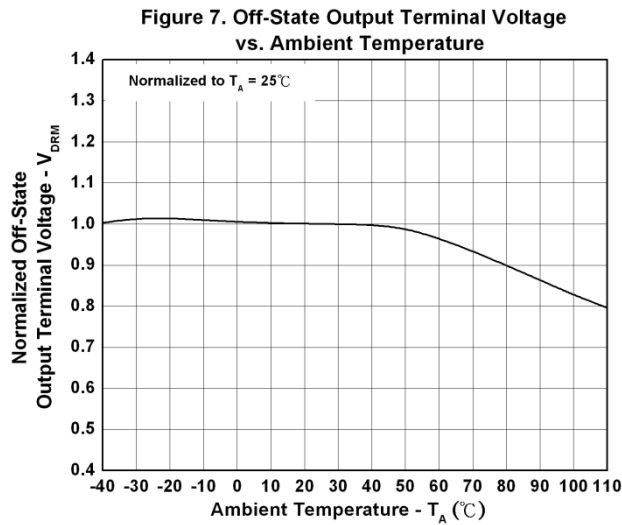
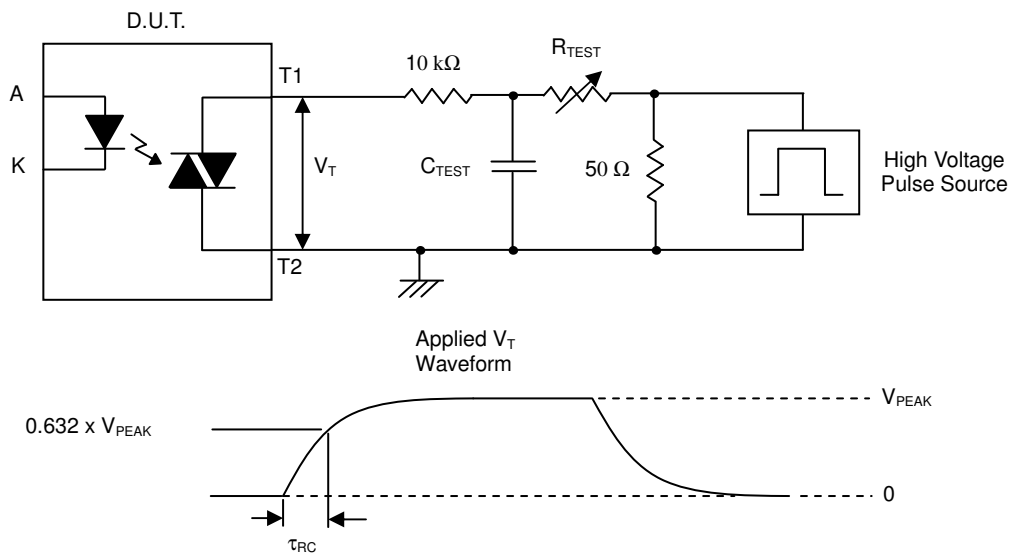

Figure 8. Static dv/dt Test Circuit & Waveform



Measurement Method

The high voltage pulse is set to the required V_{PEAK} value and applied to the D.U.T. output side through the RC circuit above. LED current is not applied. The waveform V_T is monitored using a x100 scope probe. By varying R_{TEST} , the dv/dt (slope) is increased, until the D.U.T. is observed to trigger (waveform collapses). The dv/dt is then decreased until the D.U.T. stops triggering. At this point, τ_{RC} is recorded and the dv/dt calculated.

$$dv/dt = \frac{0.632 \times V_{PEAK}}{\tau_{RC}}$$

For example, $V_{PEAK} = 400V$ for EL302X series. The dv/dt value is calculated as follows:

$$dv/dt = \frac{0.63 \times 400}{\tau_{RC}} = \frac{252}{\tau_{RC}}$$

Order Information

Part Number

ELM302X(Z)-V
or **ELM305X(Z)-V**

Note

- X = Part No. (2,3 or 4)
- Z = Tape and reel option (TA, TB or none).
- V = VDE safety approved (optional)

Option	Description	Packing quantity
None	Standard	100 units per tube
None	Standard + VDE safety optional	100 units per tube
(TA)	TA tape & reel option	3000 units per reel
(TB)	TB tape & reel option	3000 units per reel
(TA)-V	TA tape & reel option + VDE safety optional	3000 units per reel
(TB)-V	TB tape & reel option + VDE safety optional	3000 units per reel

Package Dimension (Dimensions in mm)

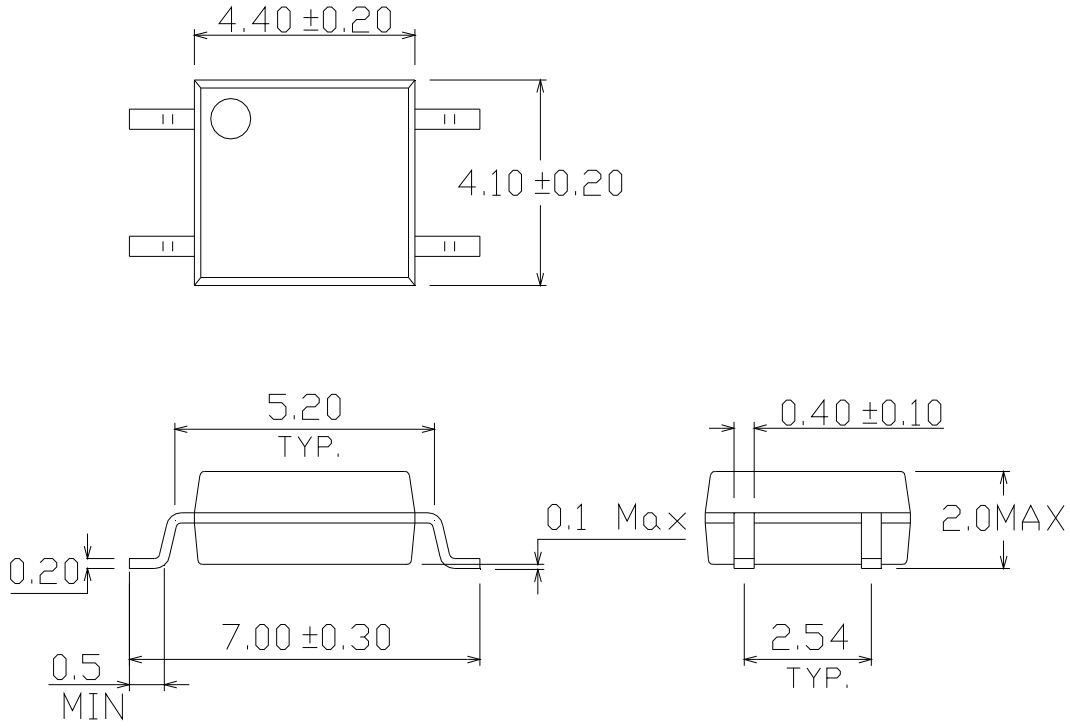

Recommended pad layout for surface mount leadform

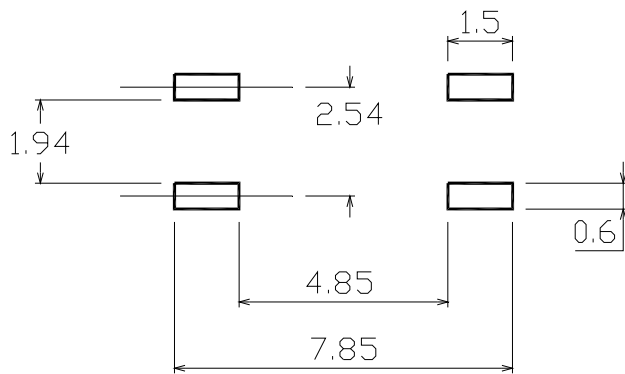

Device Marking



Notes

EL	denotes Everlight
M3054	denotes Device Number
Y	denotes 1 digit Year code
WW	denotes 2 digit Week code
V	denotes VDE safety option (optional)

Tape & Reel Packing Specifications

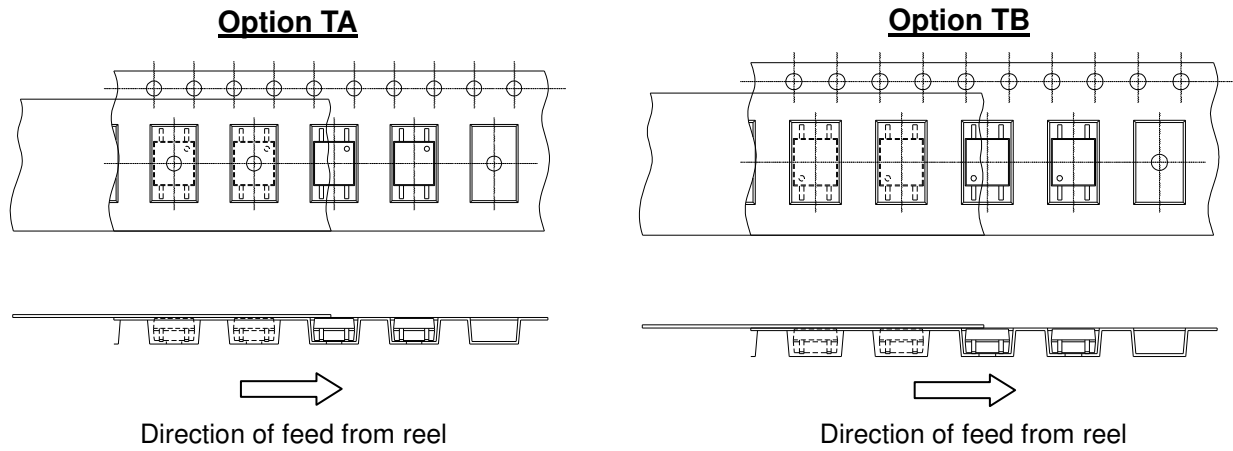

Tape dimensions

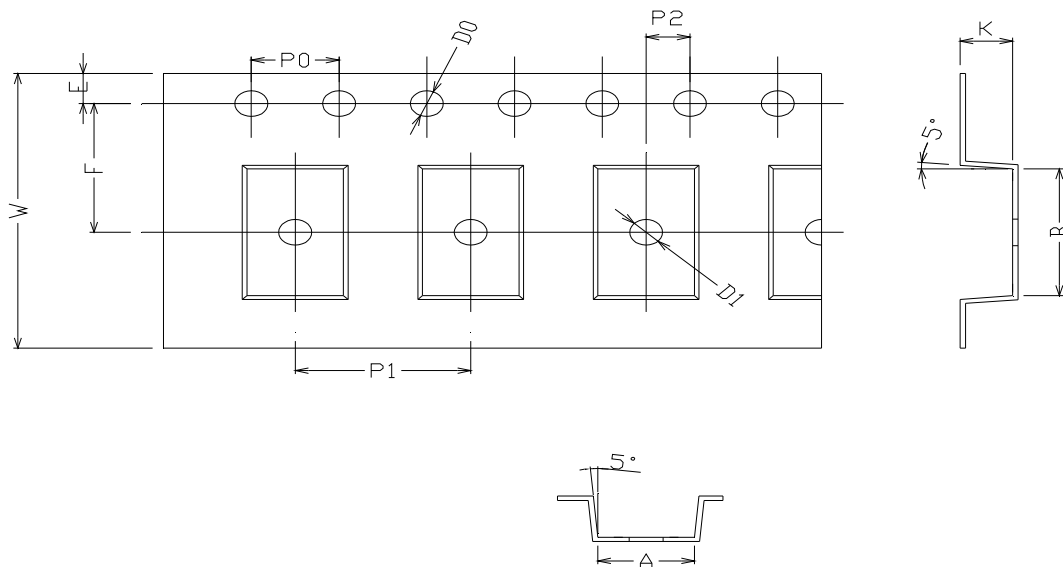

Dimension No.	A	B	Do	D1	E	F
Dimension (mm)	4.4 ± 0.1	7.4 ± 0.1	1.5 + 0.1/-0	1.5 ± 0.1	1.75 ± 0.1	7.5 ± 0.1

Dimension No.	Po	P1	P2	t	W	K
Dimension (mm)	4.0 ± 0.15	8.0 ± 0.1	2.0 ± 0.1	0.25 ± 0.03	16.0 ± 0.2	2.4 ± 0.1

Precautions for Use

1. Soldering Condition

1.1 (A) Maximum Body Case Temperature Profile for evaluation of Reflow Profile

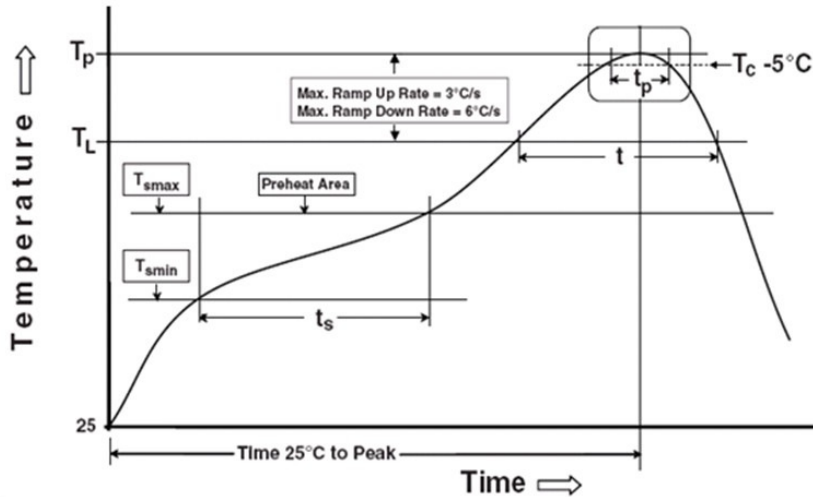

Note:

Reference: IPC/JEDEC J-STD-020D

Preheat

Temperature min (T_{smin})	150 °C
Temperature max (T_{smax})	200 °C
Time (T_{smin} to T_{smax}) (t_s)	60-120 seconds
Average ramp-up rate (T_{smax} to T_p)	3 °C/second max

Other

Liquidus Temperature (T_L)	217 °C
Time above Liquidus Temperature (t_L)	60-100 sec
Peak Temperature (T_p)	260 °C
Time within 5 °C of Actual Peak Temperature: $T_p - 5^\circ\text{C}$	30 s
Ramp- Down Rate from Peak Temperature	6 °C /second max.
Time 25 °C to peak temperature	8 minutes max.
Reflow times	3 times

DISCLAIMER

1. Above specification may be changed without notice. EVERLIGHT will reserve authority on material change for above specification.
2. When using this product, please observe the absolute maximum ratings and the instructions for using outlined in these specification sheets. EVERLIGHT assumes no responsibility for any damage resulting from use of the product which does not comply with the absolute maximum ratings and the instructions included in these specification sheets.
3. These specification sheets include materials protected under copyright of EVERLIGHT corporation. Please don't reproduce or cause anyone to reproduce them without EVERLIGHT's consent.