



Chipsmall Limited consists of a professional team with an average of over 10 year of expertise in the distribution of electronic components. Based in Hongkong, we have already established firm and mutual-benefit business relationships with customers from,Europe,America and south Asia,supplying obsolete and hard-to-find components to meet their specific needs.

With the principle of “Quality Parts,Customers Priority,Honest Operation,and Considerate Service”,our business mainly focus on the distribution of electronic components. Line cards we deal with include Microchip,ALPS,ROHM,Xilinx,Pulse,ON,Everlight and Freescale. Main products comprise IC,Modules,Potentiometer,IC Socket,Relay,Connector.Our parts cover such applications as commercial,industrial, and automotives areas.

We are looking forward to setting up business relationship with you and hope to provide you with the best service and solution. Let us make a better world for our industry!



Contact us

Tel: +86-755-8981 8866 Fax: +86-755-8427 6832

Email & Skype: info@chipsmall.com Web: www.chipsmall.com

Address: A1208, Overseas Decoration Building, #122 Zhenhua RD., Futian, Shenzhen, China



High Current, Plastic Power Supply Connectors

EM Series

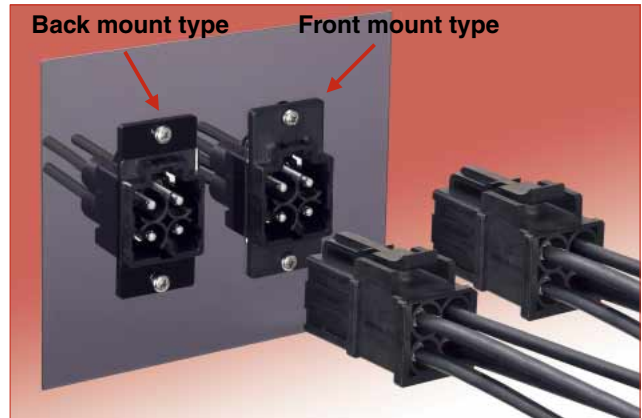

■ Features

1. 4-positions with high current capability (three-phase power supply and ground)

- Rated current of 50A per contact (50A/3contacts) with 8 AWG or corresponding wire. 70A per contact with 8 AWG wire and ambient temperature 25°C.
- Rated current of 30A per contact (30A × 3contacts) with 10 AWG or corresponding wire.
- (Please refer to the charts below concerning the relation between ambient temperature and working current value.)

2. Easy crimp termination

Crimp termination provides easy and stable termination process.

3. Standard tooling available

Terminals can be crimped with a standard tool in accordance with JIS C 9711.

4. Sequenced mating

Ground terminal makes contact first before power terminals touch.

5. Snap-in lock is easy to operate

Lock operation can be done by simply snapping the plug to the receptacle.

6. Attachment Styles

- DIN rail attachment type
- Snap-on attachment to 35mm width DIN rail.
- Panel attachment type
- Both front and back mounting applicable.

7. Ten keying combinations possible

Guide keys prevent incorrect insertions when multiple connectors are used together at the same time.

8. Meets approved safety standards

TÜV, UL certified.

Mated dimensions

(Mounted and mated dimensions on DIN rail)

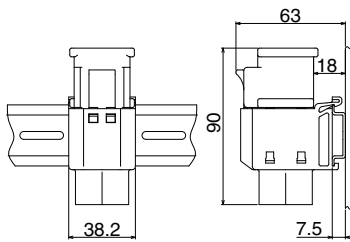

(Mounted and Mated dimensions on panel)

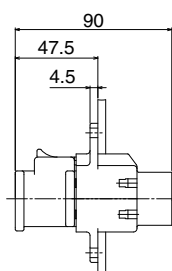

Derating curve

8 AWG

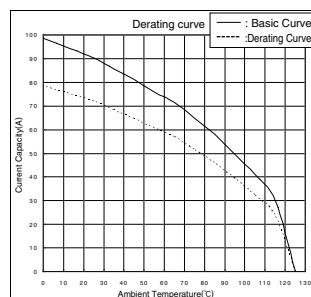

10 AWG

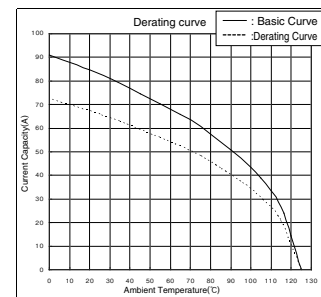

Note 1 : Derating curve is a curve that is obtained by multiplying the current value of the basic curve by derating factor of 0.8.

Note 2 : The value of rated current varies with the ambient temperature. It is recommended to use the product within the derating curve zone. When using a UL or TÜV approved product, please use the product within the specified range as well as the derating curve area.

Product Specifications

Rating	Current rating (Note 2)	30A (10 AWG) 70A (8 AWG, Ambient Temperature 25°C)	Operating temperature range	-40°C to 125°C (Note 1)
	Voltage rating	AC 1000V, DC 1000V	Storage temperature range	-10°C to 60°C
UL, TÜV	Current rating (Note 2)	30A (10 AWG) 50A (8 AWG)	Operating temperature range	-40°C to 125°C (Note 1)
	Voltage rating	AC 500V, DC 500V	Storage temperature range	-10°C to 60°C

Note 1 : Including temperature rise due to current carrying.

Note 2 : The value of rated current varies with the ambient temperature. It is recommended to use the product within the derating curve zone. When using a UL or TÜV approved product, please use the product within the specified range as well as the derating curve area.

Item	Specification	Condition
1. Contact resistance	1mΩ max.	Measured at DC 1A
2. Insulation resistance	5000MΩ min.	Measured at DC 500V
3. Withstanding voltage	No flashover and insulation breakdown	AC 4260V for 1 minute
4. Vibration resistance	No electrical discontinuity of 10μs or more	10→50→10Hz/cycle, single amplitude of 0.75mm, five minutes/cycle, three directions, 10 cycles for each direction
5. Shock resistance	No electrical discontinuity of 10μs or more	Acceleration of 490m/s ² , duration of 11ms, three directions, three times for each direction
6. Durability	Contact resistance : 1mΩ max.	100 cycles
7. Temperature cycle	Insulation resistance : 5000MΩ min.	-55°C for 30 minutes→room temperature for 2 to 3 minutes→+125°C for 30 minutes→room temperature for 2 to 3 minutes, 5 cycles
8. Humidity resistance (Normal condition)	Insulation resistance : 50MΩ min. (at high humidity condition) 500MΩ min. (at dry condition)	Exposed for 96 hours at the temperature of 40°C and the humidity of 90 to 95%

Materials / Finish

Item	Material	Finish	Remarks
Insulation	PBT resin	—	UL94V-0
Contact	Copper alloy	Tin plated (Nickel under plating)	—

Product Number Structure

Refer to the chart below when determining the product specifications from the product number. Please select from the product numbers listed in this catalog when placing orders.

●Connector

EM 35 M P - 4 S C ()**

① ② ③ ④ ⑤ ⑥ ⑦ ⑧

●Guide key

EM - GK ()**

① ④ ⑧

●Crimp terminal

EM - S C - 1 4 3 ()**

① ⑥ ⑦ ⑨ ⑩ ⑪ ⑧

① Series name : EM	⑦ Type of termination : C = Crimp
② Shell size : 35	⑧ This position will be used to indicate changes or variations to the product. When needed, there will be a 2 digit number within the parentheses. This number will correspond to specific changes and/or variations with the part.
③ Specialty : M=Mold type(Plastic type)	
④ Connector type : P= Plug R= Receptacle (DIN rail attachment type) RA= Receptacle (Panel attachment type) GK= Guide key	⑨ Terminal shape : 1= Loose piece terminal
⑤ Number of contacts : 4	⑩ Shape modification : Design variation in the same size terminal is indicated with serial numbers starting from 1.
⑥ Contact gender : S=Female contact, P=Male contact	
	⑪ Plating : 3 = Tin plated

■ Plug



Part No.	HRS No.	Packaging
EM35MP-4SC	138-0020-9	1
EM35MP-4PC	138-0021-1	

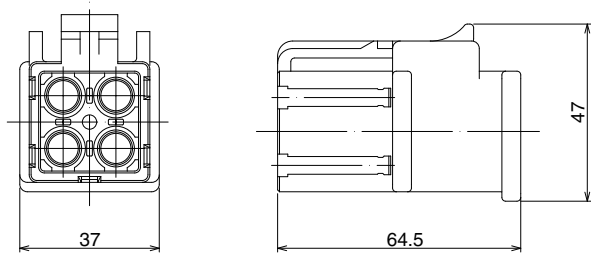

■ Receptacle(DIN rail attachment type)



Part No.	HRS No.	Packaging
EM35MR-4PC	138-0022-4	1
EM35MR-4SC	138-0023-7	

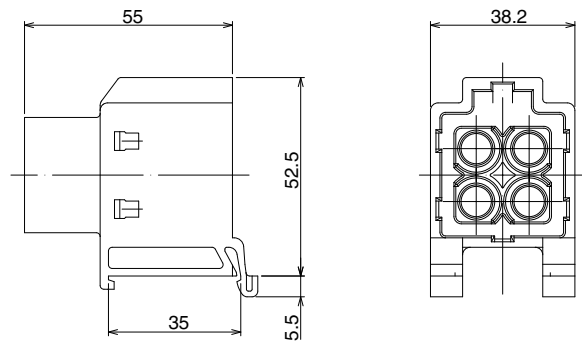

■ Receptacle(Panel attachment type)



Part No.	HRS No.	Packaging
EM35MRA-4PC	138-0028-0	1

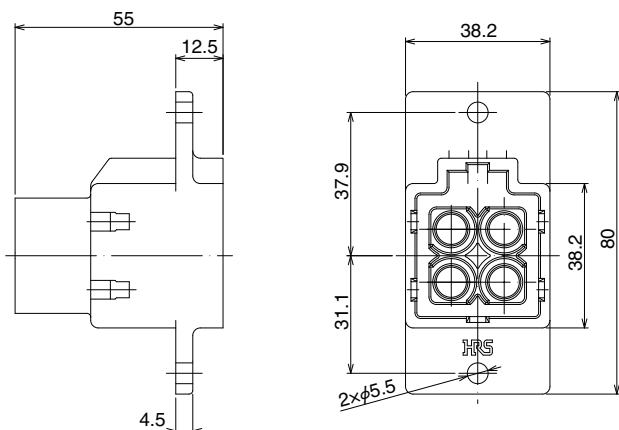

■ Cap

● For receptacle



Part No.	HRS No.	Applicable connector	Packaging
EM35MR-C	138-0029-3	EM35MR-4PC	1
		EM35MR-4SC	
		EM35MRA-4PC	

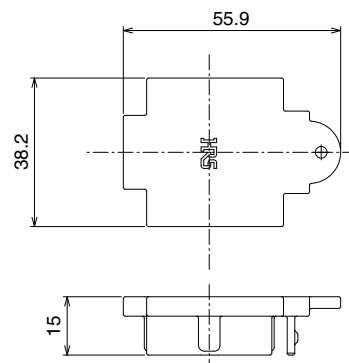

■ Crimp terminals

◆ Male terminals

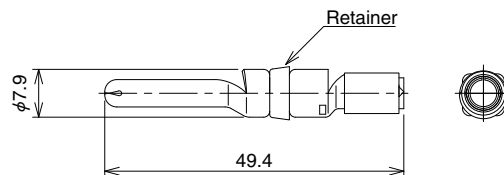

Type	Part No.	HRS No.	Applicable wire	Remarks
Loose piece terminals	EM-PC-113(01)	138-0011-8 01	(1) Cross sectional area of conductor : 5.26 to 5.57mm ² (corresponding to 10 AWG) (2) Outside diameter of conductor : ϕ 3.1 max. (3) Outside diameter of jacket : ϕ 8.7 max. (Wire needs to meet all the specifications listed in 1, 2 and 3.)	Retainer : black
	EM-PC-133	138-0019-0	(1) Cross sectional area of conductor : 8mm ² (2) Outside diameter of conductor : ϕ 3.7 max. (3) Outside diameter of jacket : ϕ 8.7 max. (Wire needs to meet all the specifications listed in 1, 2 and 3.)	Retainer : white
	EM-PC-143(01)	138-0025-2 01	(1) Cross sectional area of conductor : 8.44 to 8.92mm ² (corresponding to 8 AWG) (2) Outside diameter of conductor : ϕ 4.4 max. (3) Outside diameter of jacket : ϕ 11.5 max. (Wire needs to meet all the specifications listed in 1, 2 and 3.)	Retainer : purple

Note : 4 pcs/pack

◆ Female terminals

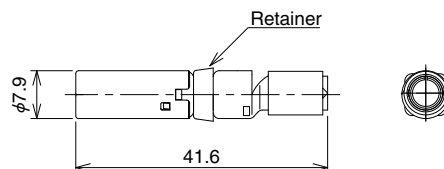

Type	Part No.	HRS No.	Applicable wire	Remarks
Loose piece terminals	EM-SC-113(01)	138-0010-5 01	(1) Cross sectional area of conductor : 5.26 to 5.57mm ² (corresponding to 10 AWG) (2) Outside diameter of conductor : ϕ 3.1 max. (3) Outside diameter of jacket : ϕ 8.7 max. (Wire needs to meet all the specifications listed in 1, 2 and 3.)	Retainer : black
	EM-SC-133	138-0018-7	(1) Cross sectional area of conductor : 8mm ² (2) Outside diameter of conductor : ϕ 3.7 max. (3) Outside diameter of jacket : ϕ 8.7 max. (Wire needs to meet all the specifications listed in 1, 2 and 3.)	Retainer : white
	EM-SC-143(01)	138-0024-0 01	(1) Cross sectional area of conductor : 8.44 to 8.92mm ² (corresponding to 8 AWG) (2) Outside diameter of conductor : ϕ 4.4 max. (3) Outside diameter of jacket : ϕ 11.5 max. (Wire needs to meet all the specifications listed in 1, 2 and 3.)	Retainer : purple

Note : 4 pcs/pack

◆ Coding key

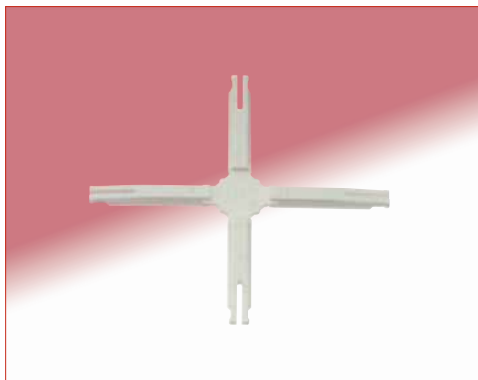

Part No.	HRS No.
EM-GK	138-0026-5

Note : 25 pcs/pack
Each sprue holds 4 coding keys and yields a total of 100 coding keys.

Coding keys are used to create keying combinations to prevent incorrect insertion. This is especially useful when multiple parts are being used together. Coding keys need to be installed on both the plug and receptacle when creating specific combinations.

Please contact a Hirose representative for details and proper use of coding keys.

◆ Coding key combination table

(Using two coding keys on the plug and three on the receptacle can make up to ten different combinations.)

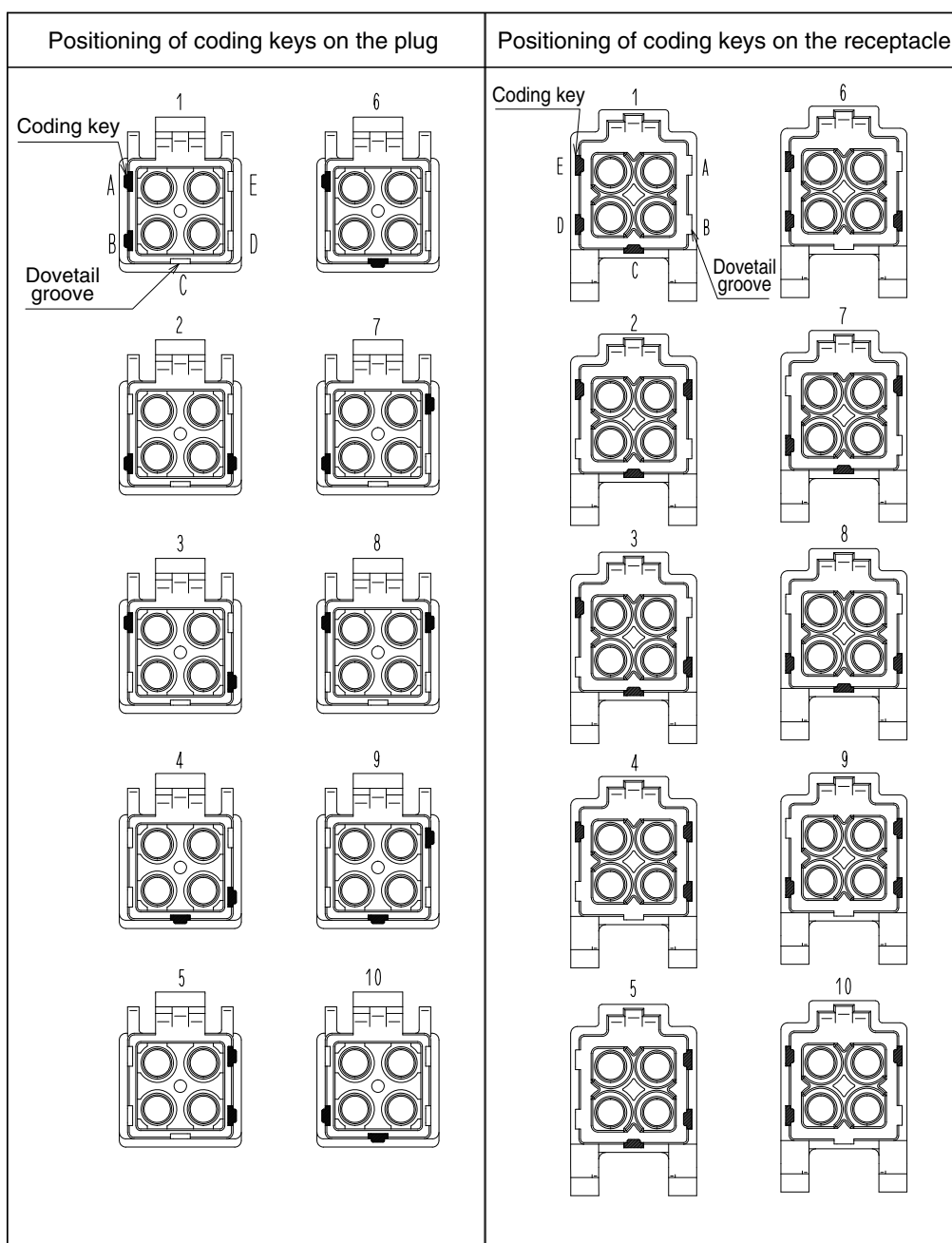

◆ Tools

Type	Part No.	HRS No.	Applicable terminal
Manual crimping tool	Note 1	—	EM-PC-113 (01) , EM-SC-113 (01) EM-PC-133 , EM-SC-133 EM-PC-143 (01) , EM-SC-143 (01)
Contact extraction tool	EM-8-TP	150-0249-3	EM-PC-113 (01) , EM-SC-113 (01) EM-PC-133 , EM-SC-133 EM-PC-143 (01) , EM-SC-143 (01)

Note 1 : About manual crimping tools :

An applicable tool is a commercially available tool conforming to the JIS C 9711 standard “Termination tools for wire connector of interior wiring”. Only use the recommended tools noted below.

Recommended crimping tools

Tool manufacturer	Part No.
HOZAN TOOL INDUSTRIAL CO., LTD.	P-75
LOBTEX Co., Ltd.	AK15A
NICHIFU TERMINAL INDUSTRIES Co., Ltd.	NH1

● Manual crimping tool (Example)

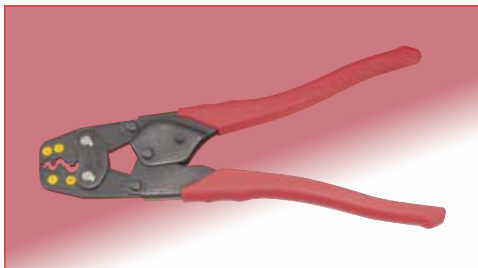

● Contact extraction tool

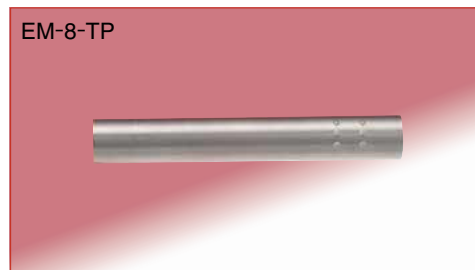

◆ Panel cut out dimensions

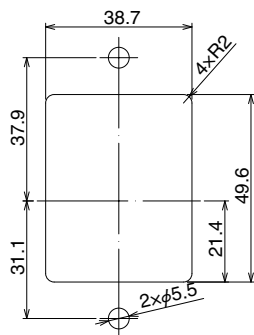

◆ Panel attachment dimensions

For front mount

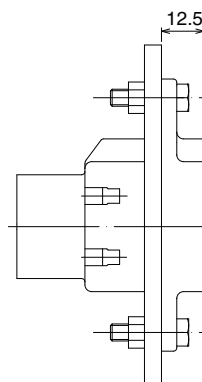

For back mount
(Panel thickness : 8mm max.)

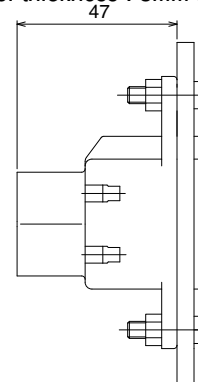

◆ Precautions when using the EM series connectors

1. Switch off the power before mating or un-mating the connectors.
2. Do not touch the terminal portion when the connector is energized. Doing so is potentially dangerous and can lead to injury.
3. Please contact a Hirose representative for harness work procedures and instruction manuals.



HIROSE ELECTRIC CO.,LTD.

2-6-3,Nakagawa Chuoh,Tsuzuki-Ku,Yokohama-Shi 224-8540,JAPAN

TEL: +81-45-620-3526 Fax: +81-45-591-3726

<http://www.hirose.com>

<http://www.hirose-connectors.com>