



Chipsmall Limited consists of a professional team with an average of over 10 year of expertise in the distribution of electronic components. Based in Hongkong, we have already established firm and mutual-benefit business relationships with customers from,Europe,America and south Asia,supplying obsolete and hard-to-find components to meet their specific needs.

With the principle of “Quality Parts,Customers Priority,Honest Operation,and Considerate Service”,our business mainly focus on the distribution of electronic components. Line cards we deal with include Microchip,ALPS,ROHM,Xilinx,Pulse,ON,Everlight and Freescale. Main products comprise IC,Modules,Potentiometer,IC Socket,Relay,Connector.Our parts cover such applications as commercial,industrial, and automotives areas.

We are looking forward to setting up business relationship with you and hope to provide you with the best service and solution. Let us make a better world for our industry!



## Contact us

Tel: +86-755-8981 8866 Fax: +86-755-8427 6832

Email & Skype: info@chipsmall.com Web: www.chipsmall.com

Address: A1208, Overseas Decoration Building, #122 Zhenhua RD., Futian, Shenzhen, China



# EMI8041, EMI8042, EMI8043



ON Semiconductor®

[www.onsemi.com](http://www.onsemi.com)

## Product Preview

# Common Mode Filter with ESD Protection

### Functional Description

The EMI804x is a family of Common Mode Filters (CMF) with integrated ESD protection, a first in the industry. Differential signaling I/Os can now have both common mode filtering and ESD protection in one package. The EMI804x protects against ESD pulses up to  $\pm 15$  kV contact per the IEC61000-4-2 standard.

The EMI804x is well-suited for protecting systems using high-speed differential ports such as USB 3.0, HDMI 1.3/1.4/2.0; corresponding ports in removable storage and other applications.

The EMI804x is available in a RoHS-compliant, XDFN6 for 1 Differential Pair, XDFN10 for 2 Differential Pair and XDFN16 package for 3 Differential Pair.

### Features

- Total Insertion Loss  $DM_{LOSS} < 2.5$  dB at 2.5 GHz
- Large Differential Mode Cutoff Frequency  $f_{3dB} > 5$  GHz
- High Common Mode Stop Band Attenuation:  
15 dB at 700 MHz, 30 dB at 2.4 GHz
- Low Channel Resistance 6.0  $\Omega$
- Provides ESD Protection to IEC61000-4-2 Level 4,  $\pm 15$  kV Contact
- These Devices are Pb-Free, Halogen Free/BFR Free and are RoHS Compliant

### Applications

- USB 3.0
- HDMI 1.3/1.4/2.0
- MHL 2.0
- eSATA

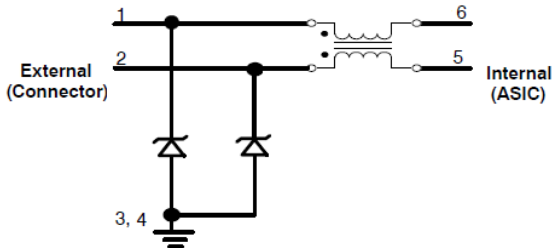
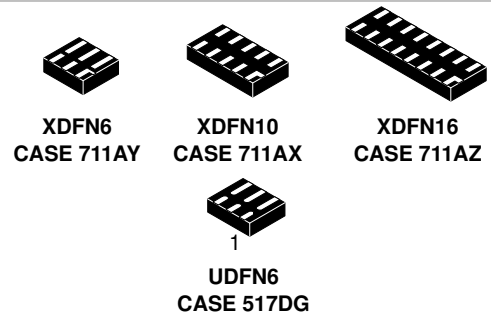
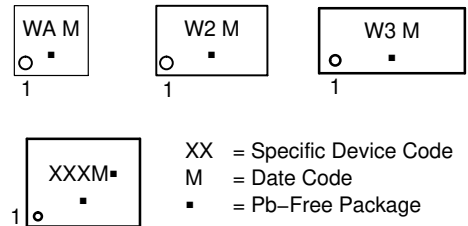

Figure 1. EMI8041 Electrical Schematic

This document contains information on a product under development. ON Semiconductor reserves the right to change or discontinue this product without notice.



### MARKING DIAGRAMS



### ELECTRICAL SCHEMATICS

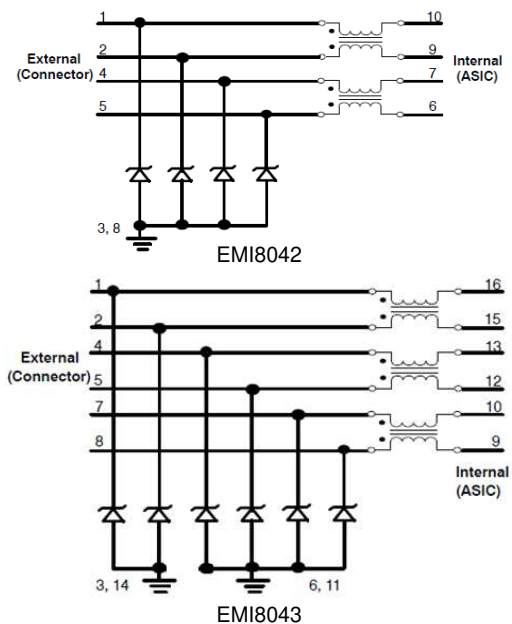

### ORDERING INFORMATION

See detailed ordering and shipping information in the package dimensions section on page 6 of this data sheet.

## EMI8041, EMI8042, EMI8043

### PIN FUNCTION DESCRIPTION

Pin Name	Device Pin			Type	Description
	EMI8041	EMI8042	EMI8043		
In_1+	1	1	1	I/O	CMF Channel 1+ to Connector (External)
In_1-	2	2	2	I/O	CMF Channel 1- to Connector (External)
Out_1+	6	10	16	I/O	CMF Channel 1+ to ASIC (Internal)
Out_1-	5	9	15	I/O	CMF Channel 1- to ASIC (Internal)
In_2+	NA	4	4	I/O	CMF Channel 2+ to Connector (External)
In_2-	NA	5	5	I/O	CMF Channel 2- to Connector (External)
Out_2+	NA	7	13	I/O	CMF Channel 2+ to ASIC (Internal)
Out_2-	NA	6	12	I/O	CMF Channel 2- to ASIC (Internal)
In_3+	NA	NA	7	I/O	CMF Channel 3+ to Connector (External)
In_3-	NA	NA	8	I/O	CMF Channel 3- to Connector (External)
Out_3+	NA	NA	10	I/O	CMF Channel 3+ to ASIC (Internal)
Out_3-	NA	NA	9	I/O	CMF Channel 3- to ASIC (Internal)
VN	3,4	3, 8	3,6,14,11	GND	Ground

### ABSOLUTE MAXIMUM RATINGS ( $T_A = 25^\circ\text{C}$ unless otherwise noted)

Parameter	Symbol	Value	Unit
Operating Temperature Range	$T_{OP}$	-40 to +85	$^\circ\text{C}$
Storage Temperature Range	$T_{STG}$	-65 to +150	$^\circ\text{C}$
Maximum Lead Temperature for Soldering Purposes (1/8" from Case for 10 seconds)	$T_L$	260	$^\circ\text{C}$
DC Current per Line	$I_{LINE}$	100	mA

Stresses exceeding those listed in the Maximum Ratings table may damage the device. If any of these limits are exceeded, device functionality should not be assumed, damage may occur and reliability may be affected.



## EMI8041, EMI8042, EMI8043

### ELECTRICAL CHARACTERISTICS ( $T_A = 25^\circ\text{C}$ unless otherwise noted)

Symbol	Parameter	Test Conditions	Min	Typ	Max	Unit
$V_{RWM}$	Reverse Working Voltage	(Note 3)		3.3		V
$V_{BR}$	Breakdown Voltage	$I_T = 1 \text{ mA}$ ; (Note 4)	4.0		9.0	V
$I_{LEAK}$	Channel Leakage Current	$T_A = 25^\circ\text{C}$ , $V_{IN} = 3.3 \text{ V}$ , $GND = 0 \text{ V}$			1.0	$\mu\text{A}$
$R_{CH}$	Channel Resistance (Pins 1–6, 2–5) – EMI8041 (Pins 1–10, 2–9, 4–7 and 5–6) – EMI8042 (Pins 1–16, 2–15, 4–13, 5–12, 7–10 and 8–9) – EMI8043			6.0		$\Omega$
$DM_{LOSS}$	Differential Mode Insertion Loss	@ 2.5 GHz		2.5		dB
$f_{3dB}$	Differential Mode Cut-off Frequency	50 $\Omega$ Source and Load Termination		5.0		GHz
$F_{atten}$	Common Mode Stop Band Attenuation	@ 700 MHz		15		dB
$V_{ESD}$	In-system ESD Withstand Voltage a) Contact discharge per IEC 61000-4-2 standard, Level 4 <b>(External Pins)</b> b) Contact discharge per IEC 61000-4-2 standard, Level 1 <b>(Internal Pins)</b>	(Notes 1 and 2)	$\pm 15$ $\pm 2$			kV
$V_{CL}$	TLP Clamping Voltage	Forward $I_{PP} = 8 \text{ A}$ Forward $I_{PP} = 16 \text{ A}$ Forward $I_{PP} = -8 \text{ A}$ Forward $I_{PP} = -16 \text{ A}$		7.26 11.8 -3.5 -6.7		V

Product parametric performance is indicated in the Electrical Characteristics for the listed test conditions, unless otherwise noted. Product performance may not be indicated by the Electrical Characteristics if operated under different conditions.

1. Standard IEC61000-4-2 with  $C_{Discharge} = 150 \text{ pF}$ ,  $R_{Discharge} = 330$ ,  $GND$  grounded.
2. These measurements performed with no external capacitor.
3. TVS devices are normally selected according to the working peak reverse voltage ( $V_{RWM}$ ), which should be equal to or greater than the DC or continuous peak operating voltage level.
4.  $V_{BR}$  is measured at pulse test current  $I_T$ .

# EMI8041, EMI8042, EMI8043

## TYPICAL CHARACTERISTICS

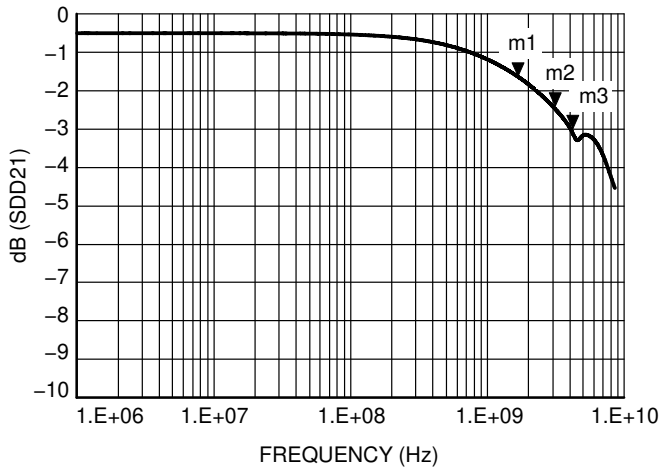

**Figure 2. Typical Differential Mode Attenuation vs. Frequency**

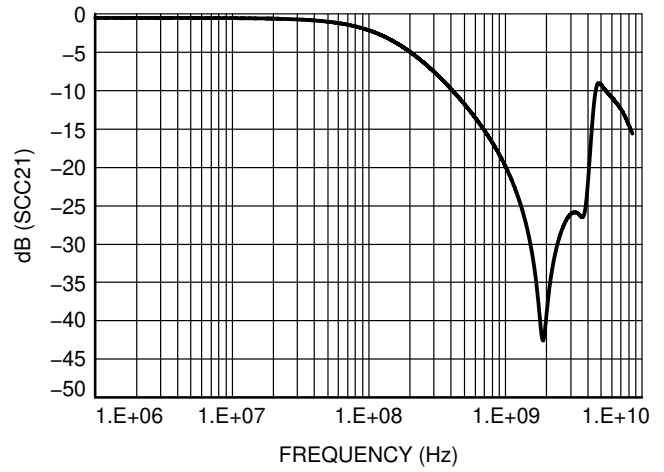

**Figure 3. Typical Common Mode Attenuation vs. Frequency**

Interface	Data Rate (Gb/s)	Fundamental Frequency (GHz)	EMI804x Insertion Loss (dB)
HDMI 1.3/1.4	3.4	1.7 (m1)	m1 = 1.65
USB 3.0	5.0	2.5 (m2)	m2 = 2.13
HDMI 2.0	6.0	3.0 (m3)	m3 = 2.41

TRANSMISSION LINE PULSE (TLP) MEASUREMENTS

Transmission Line Pulse (TLP) provides current versus voltage (I-V) curves in which each data point is obtained from a 100 ns long rectangular pulse from a charged transmission line. A simplified schematic of a typical TLP system is shown in Figure 4. TLP I-V curves of ESD protection devices accurately demonstrate the product’s ESD capability because the 10 s of amps current levels and under 100 ns time scale match those of an ESD event. This is illustrated in Figure 5 where an 8 kV IEC61000-4-2 current waveform is compared with TLP current pulses at 8 A and 16 A. A TLP curve shows the voltage at which the device turns on as well as how well the device clamps voltage over a range of current levels. Typical TLP I-V curves for the EMI804x are shown in Figure 4.

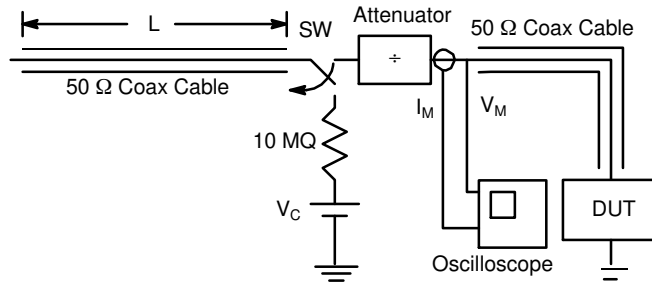

Figure 4. Simplified Schematic of a Typical TLP System

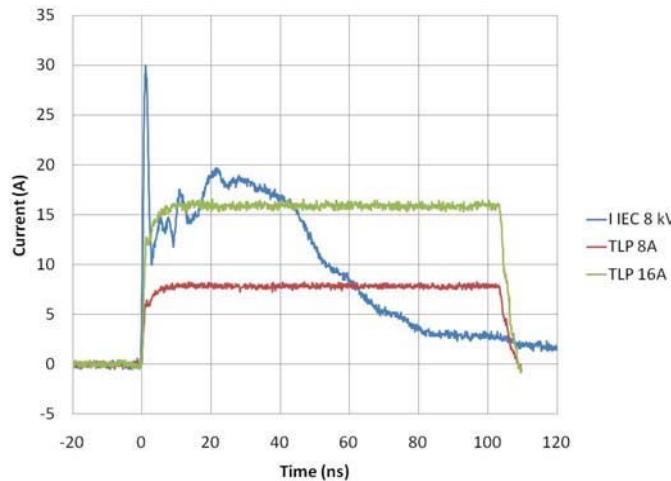

Figure 5. Comparison Between 8 kV IEC61000-4-2 and 8 A and 16 A TLP Waveforms

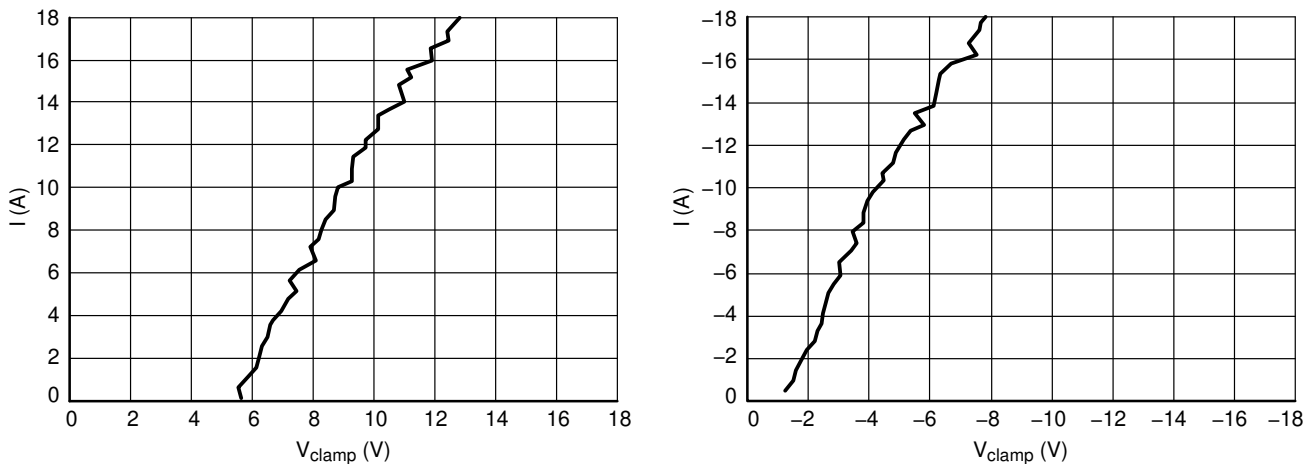
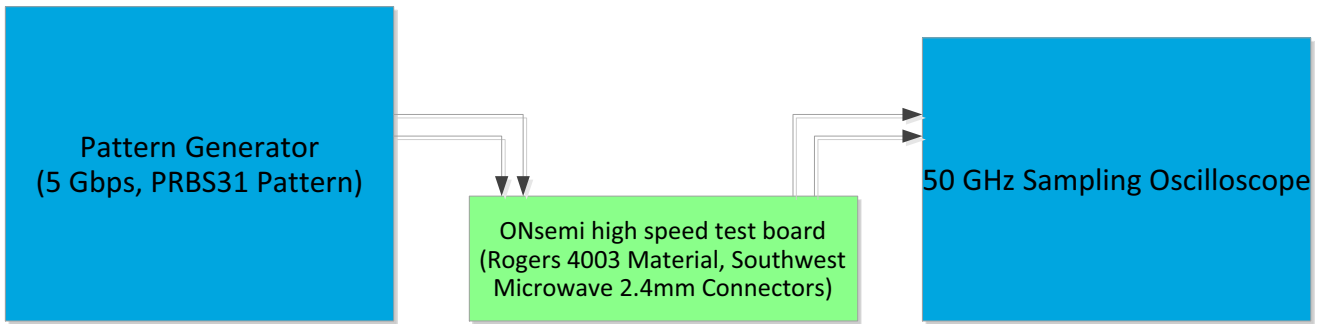
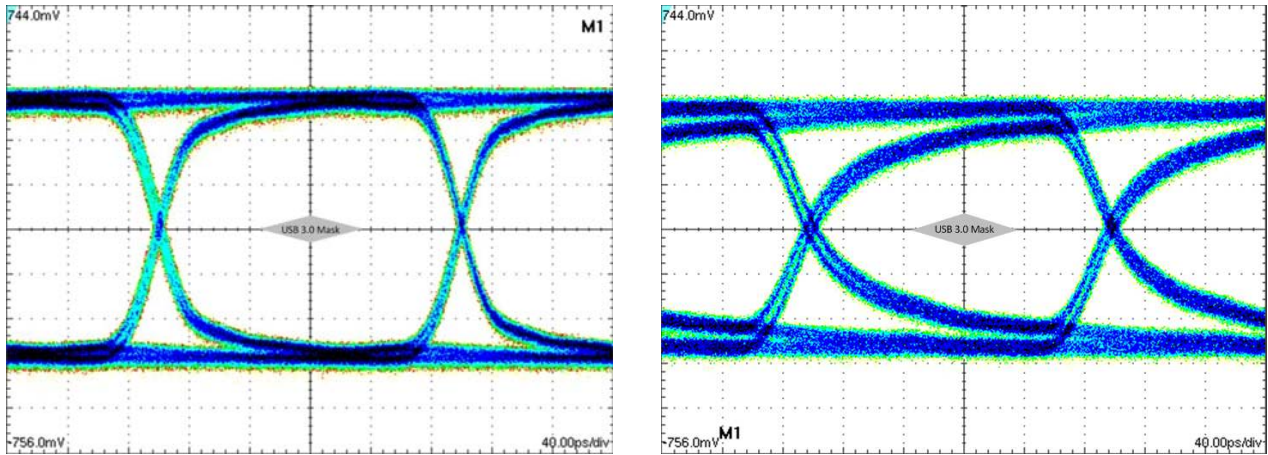

Figure 6. Positive and Negative TLP Waveforms

## EMI8041, EMI8042, EMI8043



**Figure 7. Eye Diagram Test Setup for 5Gbps Data Rate**



**Figure 8. Eye Diagram 5Gbps with and without EMI804x**

	Eye Height (mVppd)	Rise Time (ps)	Fall Time (ps)	Jrms (ps)	Jpp (ps)
Reference (No Device)-Left Figure	724	30.4	29.6	1.997	9.6
EMI804x Right Figure	405	60	60.8	3.484	16

### ORDERING INFORMATION

Orderable Part Number	Package	Shipping
EMI8041MUTAG	XDFN6 (Pb-Free)	3000 / Tape & Reel
EMI8042MUTAG	XDFN10 (Pb-Free)	3000 / Tape & Reel
EMI8043MUTAG	XDFN16 (Pb-Free)	3000 / Tape & Reel
EMI8041BMUTAG	UDFN6 (Pb-Free)	3000 / Tape & Reel

†For information on tape and reel specifications, including part orientation and tape sizes, please refer to our Tape and Reel Packaging Specifications Brochure, BRD8011/D.

# EMI8041, EMI8042, EMI8043

## PACKAGE DIMENSIONS

UDFN6 1.6x1.35, 0.5P  
CASE 517DG  
ISSUE O

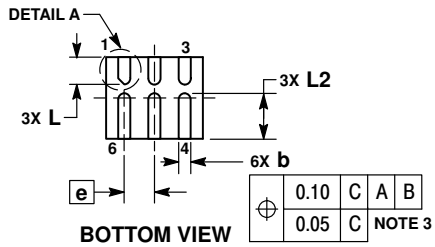
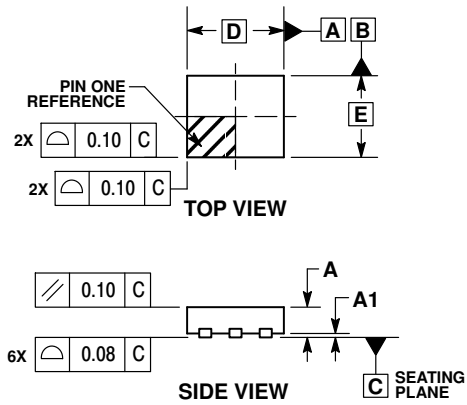

NOTES:

1. DIMENSIONING AND TOLERANCING PER ASME Y14.5M, 1994.
2. CONTROLLING DIMENSION: MILLIMETERS.
3. DIMENSION b APPLIES TO PLATED TERMINAL AND IS MEASURED BETWEEN 0.15 AND 0.30 mm FROM THE TERMINAL TIP.

MILLIMETERS		
DIM	MIN	MAX
A	0.45	0.55
A1	0.00	0.05
b	0.15	0.25
D	1.60 BSC	
E	1.35 BSC	
e	0.50 BSC	
L	0.35	0.55
L2	0.65	0.85

### RECOMMENDED MOUNTING FOOTPRINT

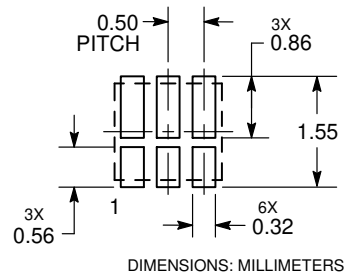

\*For additional information on our Pb-Free strategy and soldering details, please download the ON Semiconductor Soldering and Mounting Techniques Reference Manual, SOLDERRM/D.



# EMI8041, EMI8042, EMI8043

## PACKAGE DIMENSIONS

XDFN6, 1.50x1.35, 0.5P  
CASE 711AY  
ISSUE O

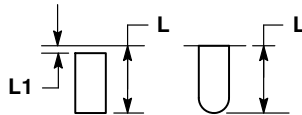
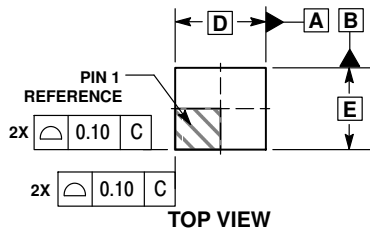

**NOTES:**

1. DIMENSIONING AND TOLERANCING PER ASME Y14.5M, 1994.
2. CONTROLLING DIMENSION: MILLIMETERS.
3. DIMENSIONS b APPLIES TO PLATED TERMINAL AND IS MEASURED BETWEEN 0.15 AND 0.30 MM FROM TERMINAL TIP.

DIM	MILLIMETERS	
	MIN	MAX
A	0.40	0.50
A1	0.00	0.05
A3	0.15 REF	
b	0.15	0.25
D	1.50 BSC	
E	1.35 BSC	
e	0.50 BSC	
L	0.35	0.55
L1	---	0.15
L2	0.65	0.85
L3	0.15 REF	

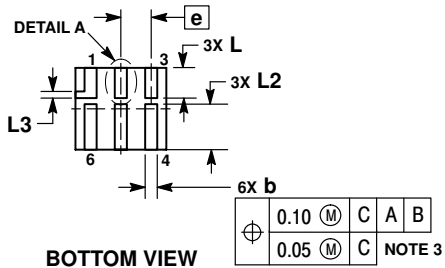
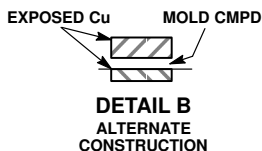
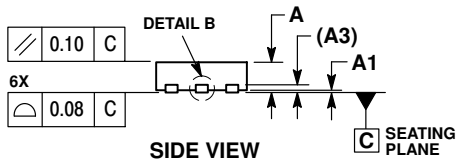

### RECOMMENDED MOUNTING FOOTPRINT

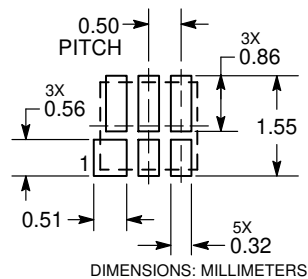

# EMI8041, EMI8042, EMI8043

## PACKAGE DIMENSIONS

XDFN10 2.50x1.35, 0.5P  
CASE 711AX  
ISSUE O

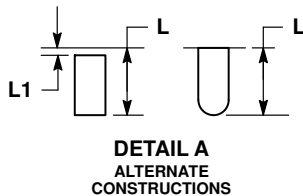
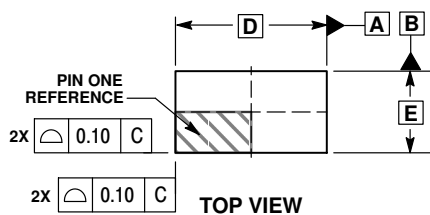

- NOTES:
1. DIMENSIONING AND TOLERANCING PER ASME Y14.5M, 1994.
  2. CONTROLLING DIMENSION: MILLIMETERS.
  3. DIMENSIONS b APPLIES TO PLATED TERMINAL AND IS MEASURED BETWEEN 0.15 AND 0.30 MM FROM THE TERMINAL TIP.

DIM	MILLIMETERS	
	MIN	MAX
A	0.40	0.50
A1	0.00	0.05
A3	0.15 REF	
b	0.15	0.25
D	2.50 BSC	
E	1.35 BSC	
e	0.50 BSC	
L	0.40	0.60
L1	---	0.15

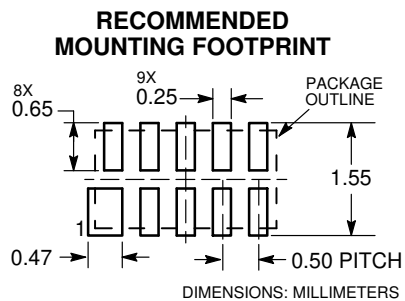
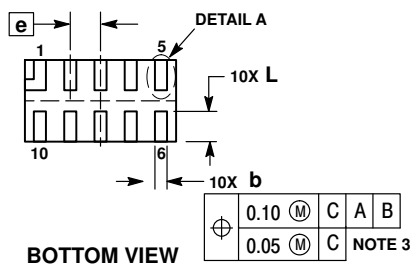
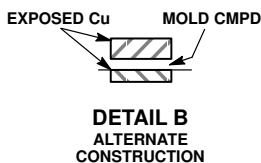
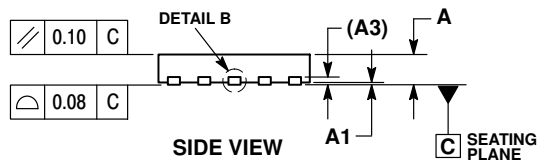

# EMI8041, EMI8042, EMI8043

## PACKAGE DIMENSIONS

XDFN16 4.0x1.35, 0.5P  
CASE 711AZ  
ISSUE O

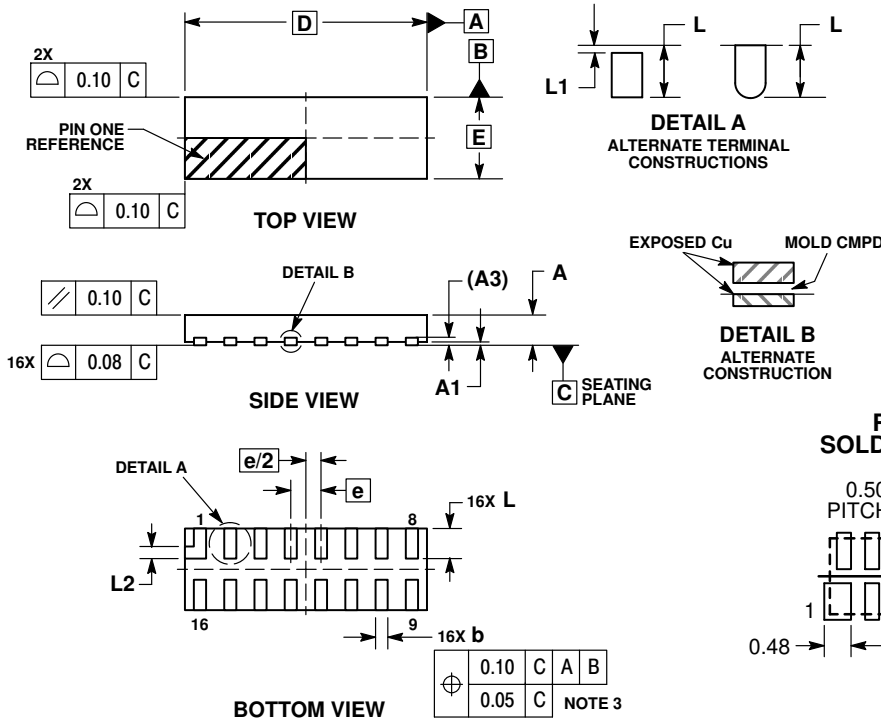

**NOTES:**

1. DIMENSIONING AND TOLERANCING PER ASME Y14.5M, 1994.
2. CONTROLLING DIMENSION: MILLIMETERS.
3. DIMENSION b APPLIES TO PLATED TERMINAL AND IS MEASURED BETWEEN 0.15 AND 0.30 mm FROM THE TERMINAL TIP.

MILLIMETERS		
DIM	MIN	MAX
A	0.40	0.50
A1	0.00	0.05
A3	0.15 REF	
b	0.15	0.25
D	4.00 BSC	
E	1.35 BSC	
e	0.50 BSC	
L	0.40	0.60
L1	---	0.15
L2	0.20 REF	

\*For additional information on our Pb-Free strategy and soldering details, please download the ON Semiconductor Soldering and Mounting Techniques Reference Manual, SOLDERRM/D.

ON Semiconductor and are registered trademarks of Semiconductor Components Industries, LLC (SCILLC). SCILLC owns the rights to a number of patents, trademarks, copyrights, trade secrets, and other intellectual property. A listing of SCILLC's product/patent coverage may be accessed at [www.onsemi.com/site/pdf/Patent-Marking.pdf](http://www.onsemi.com/site/pdf/Patent-Marking.pdf). SCILLC reserves the right to make changes without further notice to any products herein. SCILLC makes no warranty, representation or guarantee regarding the suitability of its products for any particular purpose, nor does SCILLC assume any liability arising out of the application or use of any product or circuit, and specifically disclaims any and all liability, including without limitation special, consequential or incidental damages. "Typical" parameters which may be provided in SCILLC data sheets and/or specifications can and do vary in different applications and actual performance may vary over time. All operating parameters, including "Typicals" must be validated for each customer application by customer's technical experts. SCILLC does not convey any license under its patent rights nor the rights of others. SCILLC products are not designed, intended, or authorized for use as components in systems intended for surgical implant into the body, or other applications intended to support or sustain life, or for any other application in which the failure of the SCILLC product could create a situation where personal injury or death may occur. Should Buyer purchase or use SCILLC products for any such unintended or unauthorized application, Buyer shall indemnify and hold SCILLC and its officers, employees, subsidiaries, affiliates, and distributors harmless against all claims, costs, damages, and expenses, and reasonable attorney fees arising out of, directly or indirectly, any claim of personal injury or death associated with such unintended or unauthorized use, even if such claim alleges that SCILLC was negligent regarding the design or manufacture of the part. SCILLC is an Equal Opportunity/Affirmative Action Employer. This literature is subject to all applicable copyright laws and is not for resale in any manner.

### PUBLICATION ORDERING INFORMATION

**LITERATURE FULFILLMENT:**

Literature Distribution Center for ON Semiconductor  
P.O. Box 5163, Denver, Colorado 80217 USA  
Phone: 303-675-2175 or 800-344-3860 Toll Free USA/Canada  
Fax: 303-675-2176 or 800-344-3867 Toll Free USA/Canada  
Email: [orderlit@onsemi.com](mailto:orderlit@onsemi.com)

**N. American Technical Support:** 800-282-9855 Toll Free  
USA/Canada  
**Europe, Middle East and Africa Technical Support:**  
Phone: 421 33 790 2910  
**Japan Customer Focus Center**  
Phone: 81-3-5817-1050

**ON Semiconductor Website:** [www.onsemi.com](http://www.onsemi.com)

**Order Literature:** <http://www.onsemi.com/orderlit>

For additional information, please contact your local Sales Representative