



Chipsmall Limited consists of a professional team with an average of over 10 year of expertise in the distribution of electronic components. Based in Hongkong, we have already established firm and mutual-benefit business relationships with customers from,Europe,America and south Asia,supplying obsolete and hard-to-find components to meet their specific needs.

With the principle of “Quality Parts,Customers Priority,Honest Operation,and Considerate Service”,our business mainly focus on the distribution of electronic components. Line cards we deal with include Microchip,ALPS,ROHM,Xilinx,Pulse,ON,Everlight and Freescale. Main products comprise IC,Modules,Potentiometer,IC Socket,Relay,Connector.Our parts cover such applications as commercial,industrial, and automotives areas.

We are looking forward to setting up business relationship with you and hope to provide you with the best service and solution. Let us make a better world for our industry!



## Contact us

Tel: +86-755-8981 8866 Fax: +86-755-8427 6832

Email & Skype: info@chipsmall.com Web: www.chipsmall.com

Address: A1208, Overseas Decoration Building, #122 Zhenhua RD., Futian, Shenzhen, China





# EMIF03-SIM02F2

## 3-line IPAD™, EMI filter including ESD protection

### Features

- EMI symmetrical (I/O) low-pass filter
- High efficiency in EMI filtering
- Lead-free package
- Very low PCB space consuming:  
1.42 mm x 1.42 mm
- Very thin package: 0.65 mm
- High efficiency in ESD suppression
- High reliability offered by monolithic integration
- High reduction of parasitic elements through integration and wafer level packaging

### Complies with the following standards

- IEC 61000-4-2, Level 4 on external and  $V_{cc}$  pins:
  - 15 kV (air discharge)
  - 8 kV (contact discharge)
- IEC 61000-4-2, Level 1 on internal pins:
  - 2 kV (air discharge)
  - 2 kV (contact discharge)
- MIL STD 883E - Method 3015-6 Class 3

### Applications

EMI filtering and ESD protection for:

- SIM Interface (Subscriber Identify Module)
- UIM Interface (Universal Identify Module)

### Description

The EMIF03-SIM02F2 is a highly integrated device designed to suppress EMI/RFI noise in all systems subjected to electromagnetic interference. The EMIF03 Flip Chip packaging means the package size is equal to the die size.

This filter includes an ESD protection circuitry which prevents damage to the application when subjected to ESD surges up 15kV.

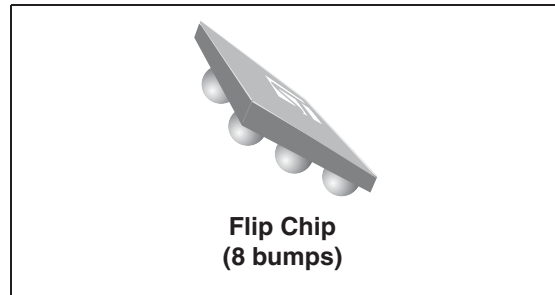

Figure 1. Pin configuration (bump side)

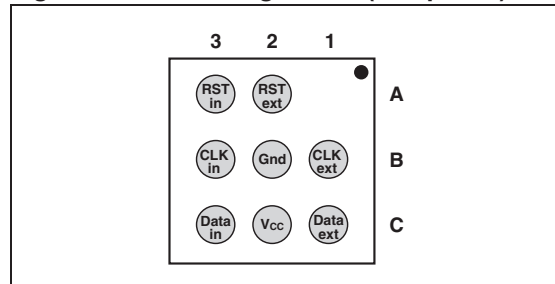
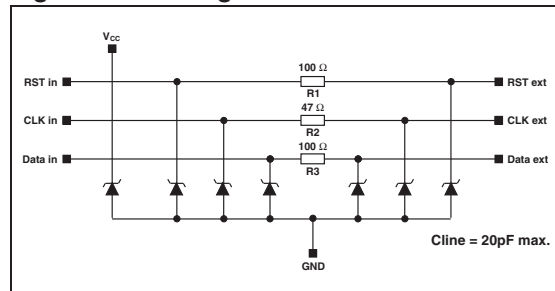

Figure 2. Configuration



TM: IPAD is a trademark of STMicroelectronics.

# 1 Characteristics

**Table 1. Absolute maximum ratings ( $T_{amb} = 25\text{ }^{\circ}\text{C}$ )**

Symbol	Parameter and test conditions	Value	Unit
$V_{PP}$	<b>Internal pins (A3, B3, C3):</b>		
	ESD discharge IEC61000-4-2, air discharge	2	kV
	ESD discharge IEC61000-4-2, contact discharge	2	
	<b>External pins (A2, B1, C2, C1):</b>		
ESD discharge IEC61000-4-2, air discharge	15		
	ESD discharge IEC61000-4-2, contact discharge	8	
$T_j$	Maximum junction temperature	125	$^{\circ}\text{C}$
$T_{op}$	Operating temperature range	-40 to +85	$^{\circ}\text{C}$
$T_{stg}$	Storage temperature range	-55 to 150	$^{\circ}\text{C}$

**Table 2. Electrical characteristics ( $T_{amb} = 25\text{ }^{\circ}\text{C}$ )**

Symbol	Parameters				
$V_{BR}$	Breakdown voltage				
$I_{RM}$	Leakage current @ $V_{RM}$				
$V_{RM}$	Stand-off voltage				
$V_{CL}$	Clamping voltage				
$R_d$	Dynamic impedance				
$I_{PP}$	Peak pulse current				
$R_{I/O}$	Series resistance between Input & Output				
$C_{line}$	Input capacitance per line				
Symbol	Test conditions	Min	Typ	Max	Unit
$V_{BR}$	$I_R = 1\text{ mA}$	6		20	V
$I_{RM}$	$V_{RM} = 3\text{ V}$			0.2	$\mu\text{A}$
$R_d$			1.5		$\Omega$
$R_1, R_3$	Tolerance $\pm 20\%$		100		$\Omega$
$R_2$	Tolerance $\pm 20\%$		47		$\Omega$
$C_{line}$	@ 0V			20	pF

**Figure 3. S21 (dB) attenuation measurement (A2-A3 line)**

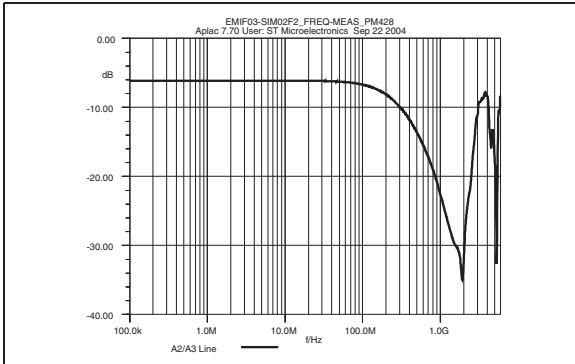

**Figure 4. S21 (dB) attenuation measurement (B1-B3 line)**

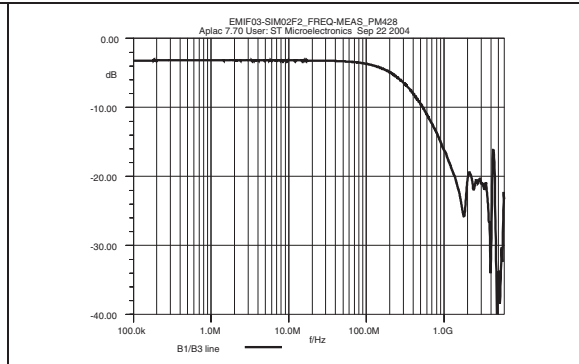

**Figure 5. S21 (dB) attenuation measurement (C1-C3 line)**

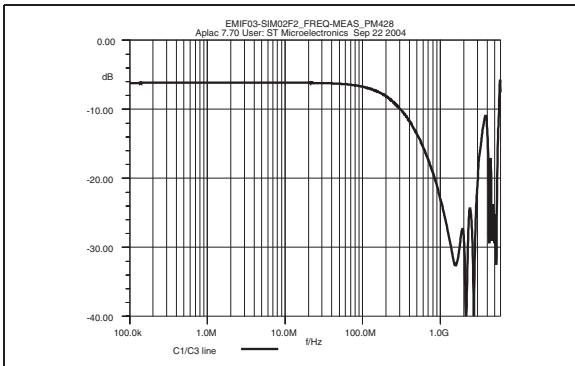

**Figure 6. Analog crosstalk measurements**

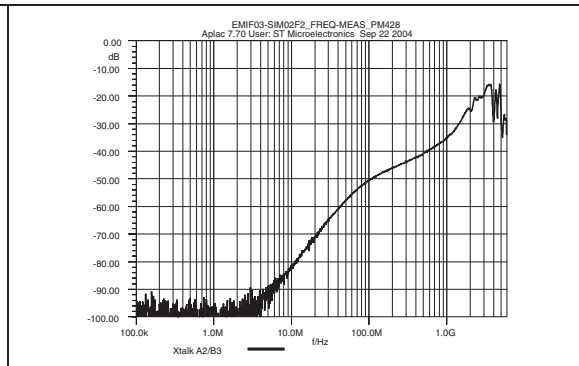

**Figure 7. Voltages when IEC61000-4-2 (+15 kV air discharge) applied to external pin**

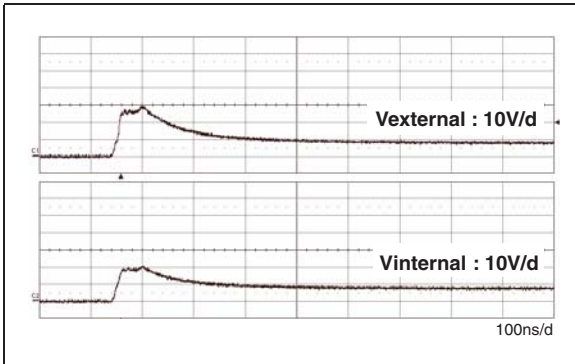

**Figure 8. Voltages when IEC61000-4-2 (-15 kV air discharge) applied to external pin**

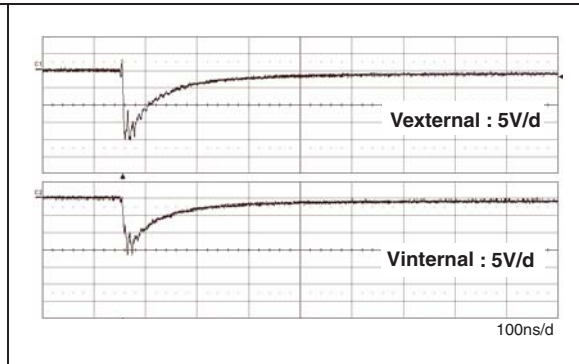
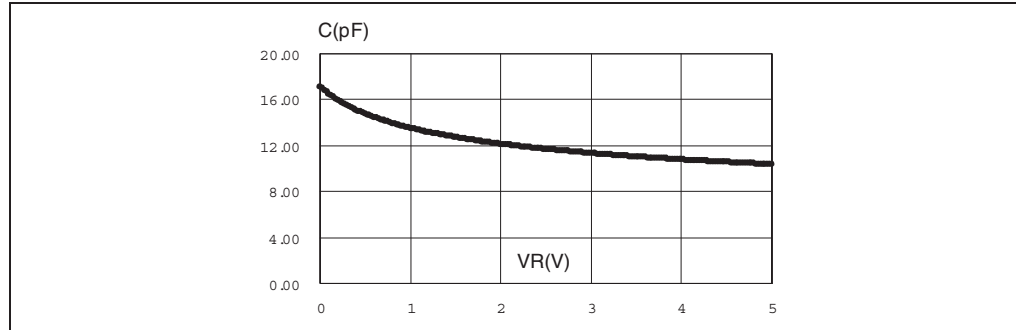

Figure 9. Line capacitance versus reverse applied voltage (typical)



## 2 Application information

Figure 10. Aplac model

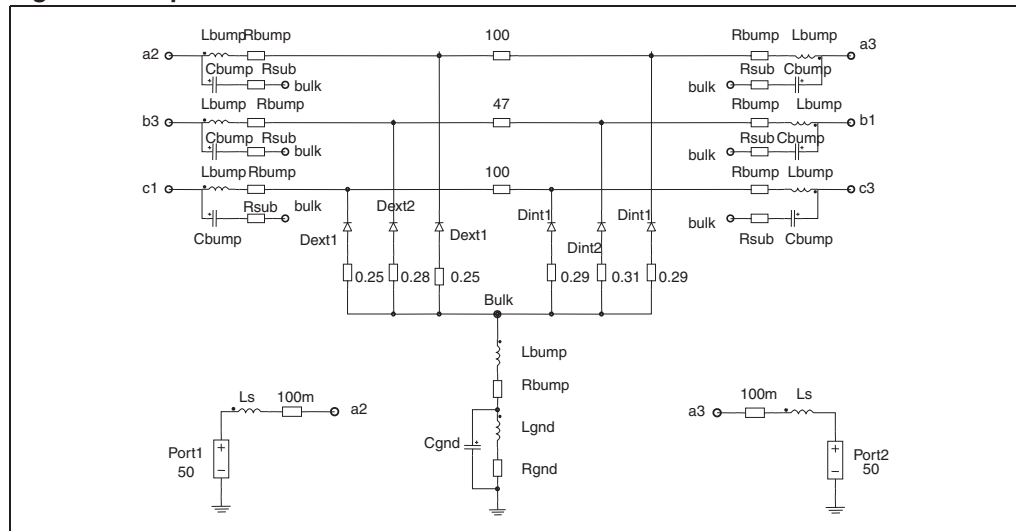
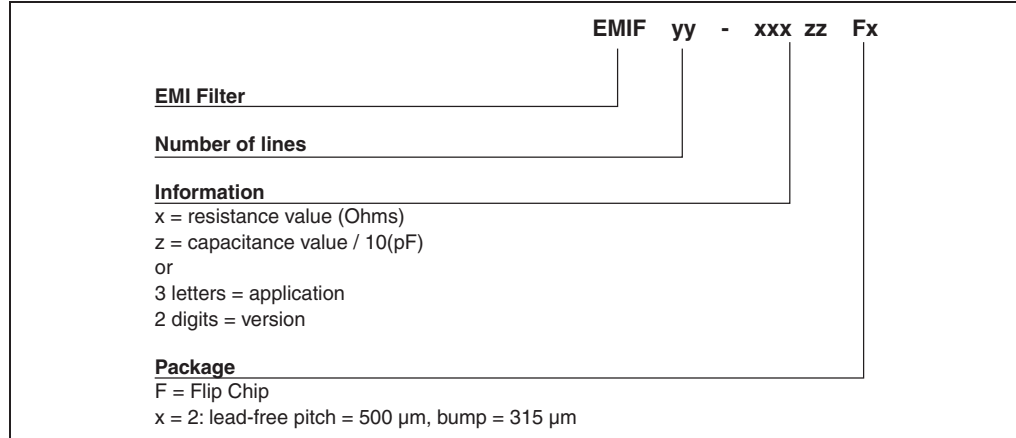

Figure 11. Aplac parameters

Ls 950pH				
Rs 150m	<u>Model Dint1</u>	<u>Model Dext1</u>	<u>Model Dint2</u>	<u>Model Dext2</u>
Cext1 15pF	BV=15	BV=15	BV=15	BV=15
Cint1 4.5pF	CJO=Cint1	CJO=Cext1	CJO=Cint2	CJO=Cext2
Cext2 14pF	IBV=1u	IBV=1u	IBV=1u	IBV=1u
Cint2 4pF	IKF=1000	IKF=1000	IKF=1000	IKF=1000
Rbump 20m	IS=10f	IS=10f	IS=10f	IS=10f
Lbump 50pH	ISR=100p	ISR=100p	ISR=100p	ISR=100p
Cbump 0.15pF	N=1	N=1	N=1	N=1
Rgnd 500m	M=0.3333	M=0.3333	M=0.3333	M=0.3333
Lgnd 50pH	RS=0.001m	RS=0.001m	RS=0.001m	RS=0.001m
Cgnd 0.15pF	VJ=0.6	VJ=0.6	VJ=0.6	VJ=0.6
Rsub 100m	TT=50n	TT=50n	TT=50n	TT=50n

### 3 Ordering information scheme

Figure 12. Ordering information scheme



### 4 Package information

In order to meet environmental requirements, ST offers these devices in ECOPACK<sup>®</sup> packages. These packages have a lead-free second level interconnect. The category of second level interconnect is marked on the inner box label, in compliance with JEDEC Standard JESD97. The maximum ratings related to soldering conditions are also marked on the inner box label. ECOPACK is an ST trademark. ECOPACK specifications are available at [www.st.com](http://www.st.com).

Figure 13. Package dimensions

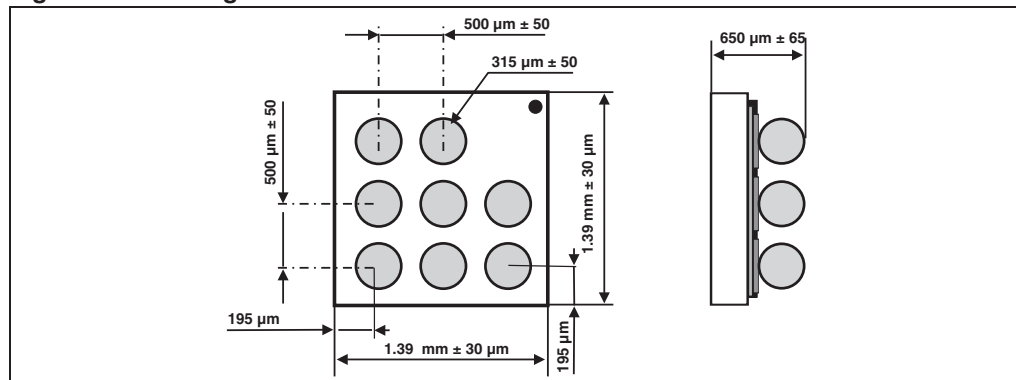

Figure 14. Footprint

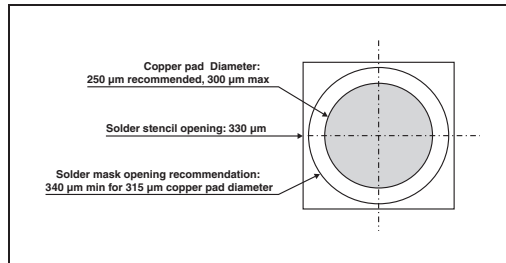

Figure 15. Marking

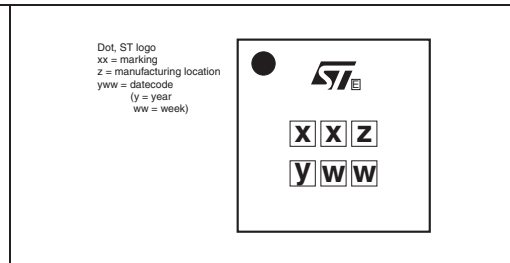
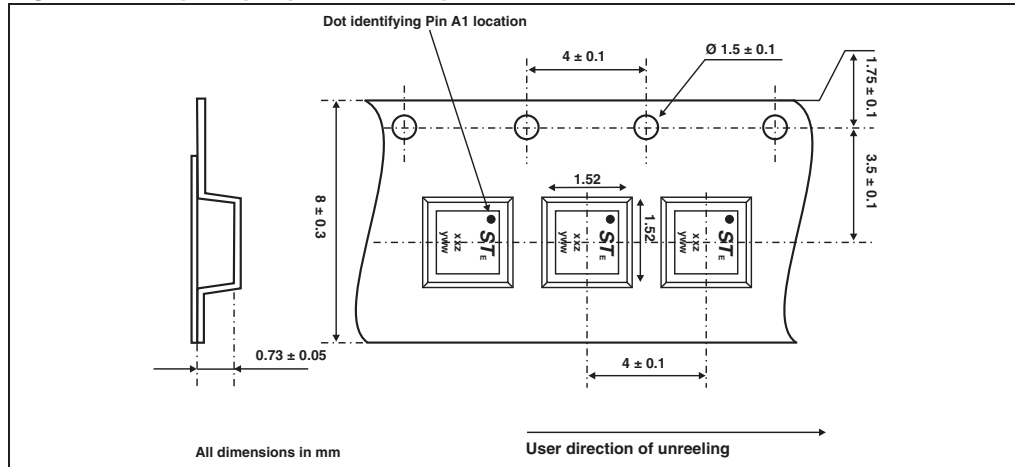

Figure 16. Flip Chip tape and reel specification



Note: More information is available in the application notes:  
 AN1235: "Flip Chip: Package description and recommendations for use"  
 AN1751: "EMI filters: Recommendations and measurements"

## 5 Ordering information

Table 3. Ordering information

Order code	Marking	Package	Weight	Base qty	Delivery mode
EMIF03-SIM02F2	GJ	Flip Chip	2.65 mg	5000	Tape and reel 7"

## 6 Revision history

**Table 4. Document revision history**

Date	Revision	Changes
08-Oct-2004	1	First issue.
20-Oct-2004	2	Minor layout update.
25-Mar-2005	3	Figure 1 on page 1: pin configuration definitions changed from RST out, CLK out and Data out to RST ext, CLK ext and Data ext.
13-Jun-2005	4	Titles in Figures 7 and 8 changed - No technical data changed
12-Sep-2005	5	“out” changed to “ext” in Figure 2.
24-Apr-2008	6	Updated ECOPACK statement. Updated <a href="#">Figure 12</a> , <a href="#">Figure 13</a> , <a href="#">Figure 14</a> , <a href="#">Figure 15</a> and <a href="#">Figure 16</a> . Reformatted to current standards.



**Please Read Carefully:**

Information in this document is provided solely in connection with ST products. STMicroelectronics NV and its subsidiaries ("ST") reserve the right to make changes, corrections, modifications or improvements, to this document, and the products and services described herein at any time, without notice.

All ST products are sold pursuant to ST's terms and conditions of sale.

Purchasers are solely responsible for the choice, selection and use of the ST products and services described herein, and ST assumes no liability whatsoever relating to the choice, selection or use of the ST products and services described herein.

No license, express or implied, by estoppel or otherwise, to any intellectual property rights is granted under this document. If any part of this document refers to any third party products or services it shall not be deemed a license grant by ST for the use of such third party products or services, or any intellectual property contained therein or considered as a warranty covering the use in any manner whatsoever of such third party products or services or any intellectual property contained therein.

**UNLESS OTHERWISE SET FORTH IN ST'S TERMS AND CONDITIONS OF SALE ST DISCLAIMS ANY EXPRESS OR IMPLIED WARRANTY WITH RESPECT TO THE USE AND/OR SALE OF ST PRODUCTS INCLUDING WITHOUT LIMITATION IMPLIED WARRANTIES OF MERCHANTABILITY, FITNESS FOR A PARTICULAR PURPOSE (AND THEIR EQUIVALENTS UNDER THE LAWS OF ANY JURISDICTION), OR INFRINGEMENT OF ANY PATENT, COPYRIGHT OR OTHER INTELLECTUAL PROPERTY RIGHT.**

**UNLESS EXPRESSLY APPROVED IN WRITING BY AN AUTHORIZED REPRESENTATIVE OF ST, ST PRODUCTS ARE NOT DESIGNED, AUTHORIZED OR WARRANTED FOR USE IN MILITARY, AIR CRAFT, SPACE, LIFE SAVING, OR LIFE SUSTAINING APPLICATIONS, NOR IN PRODUCTS OR SYSTEMS, WHERE FAILURE OR MALFUNCTION MAY RESULT IN PERSONAL INJURY, DEATH, OR SEVERE PROPERTY OR ENVIRONMENTAL DAMAGE. ST PRODUCTS WHICH ARE NOT SPECIFIED AS "AUTOMOTIVE GRADE" MAY ONLY BE USED IN AUTOMOTIVE APPLICATIONS AT USER'S OWN RISK.**

Resale of ST products with provisions different from the statements and/or technical features set forth in this document shall immediately void any warranty granted by ST for the ST product or service described herein and shall not create or extend in any manner whatsoever, any liability of ST.

ST and the ST logo are trademarks or registered trademarks of ST in various countries.

Information in this document supersedes and replaces all information previously supplied.

The ST logo is a registered trademark of STMicroelectronics. All other names are the property of their respective owners.

© 2008 STMicroelectronics - All rights reserved

STMicroelectronics group of companies

Australia - Belgium - Brazil - Canada - China - Czech Republic - Finland - France - Germany - Hong Kong - India - Israel - Italy - Japan - Malaysia - Malta - Morocco - Singapore - Spain - Sweden - Switzerland - United Kingdom - United States of America

[www.st.com](http://www.st.com)