



Chipsmall Limited consists of a professional team with an average of over 10 year of expertise in the distribution of electronic components. Based in Hongkong, we have already established firm and mutual-benefit business relationships with customers from,Europe,America and south Asia,supplying obsolete and hard-to-find components to meet their specific needs.

With the principle of “Quality Parts,Customers Priority,Honest Operation,and Considerate Service”,our business mainly focus on the distribution of electronic components. Line cards we deal with include Microchip,ALPS,ROHM,Xilinx,Pulse,ON,Everlight and Freescale. Main products comprise IC,Modules,Potentiometer,IC Socket,Relay,Connector.Our parts cover such applications as commercial,industrial, and automotives areas.

We are looking forward to setting up business relationship with you and hope to provide you with the best service and solution. Let us make a better world for our industry!



Contact us

Tel: +86-755-8981 8866 Fax: +86-755-8427 6832

Email & Skype: info@chipsmall.com Web: www.chipsmall.com

Address: A1208, Overseas Decoration Building, #122 Zhenhua RD., Futian, Shenzhen, China



EMK316BJ225MLHT

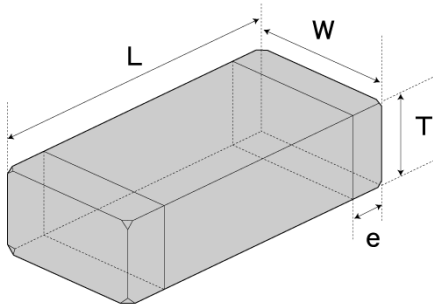

■ Features

- Item Summary
2.2 μ F \pm 20%, 16V,
X5R, 1206/3216 (EIA/JIS)
- Lifecycle Stage
Mass Production
- AEC-Q200 qualified
- Standard packaging quantity (minimum)
Taping Embossed 2000pcs

■ Products characteristics table

Capacitance	2.2 μ F \pm 20 %
Case Size (EIA/JIS)	1206/3216
Rated Voltage	16 V
tan δ (max)	3.5 %
Temperature Characteristic (EIA)	X5R
Operating Temp. Range (EIA)	-55 to +85 °C
High Temperature Loading (% Rated Voltage)	200 %
Insulation Resistance (min)	500 M Ω · μ F
RoHS2 Compliance (10 subst.)	Yes
REACH Compliance (173 subst.)	Yes
Halogen Free	Yes
Soldering	Reflow

■ External Dimensions

Dimension L	3.2 \pm 0.15 mm
Dimension W	1.6 \pm 0.15 mm
Dimension T	1.6 \pm 0.20 mm
Dimension e	0.50 +0.35/-0.25 mm

2017.04.30

The data is reference only. Electrical characteristics vary depending on environment or measurement condition.
 TAIYO YUDEN reserves the right to make change to the Date at any time without notice.
 Before making final selection, please check product specification.

Multi Layer Ceramic Capacitor

TAIYO YUDEN

-Electrical Characteristics Data-

12QA10

RoHS compliance product

○EMK316BJ225MLHT

16V 3216 X5R 2.2uF +/- 20% t=1.8mmMAX

16V 1206 X5R 2.2uF +/- 20% t=0.071inchMAX

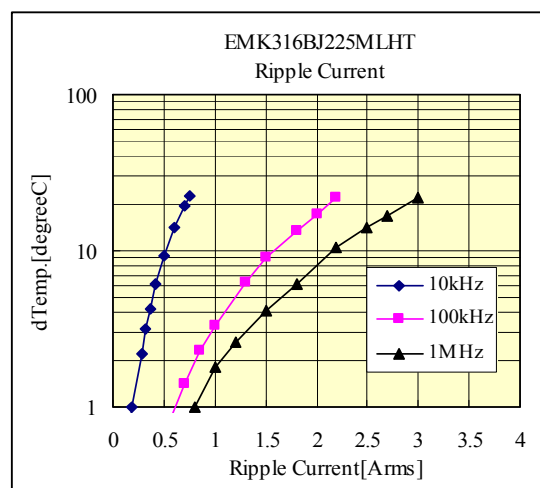
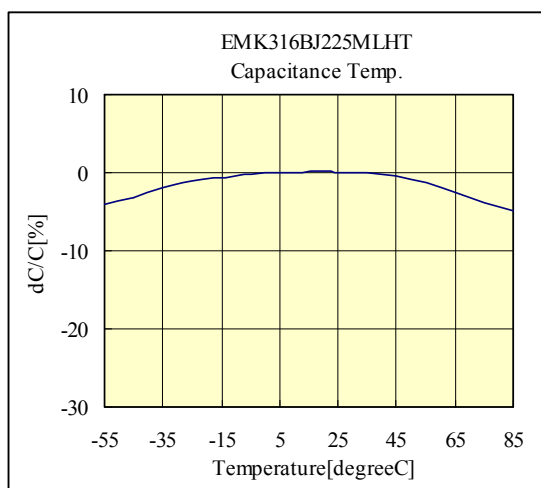
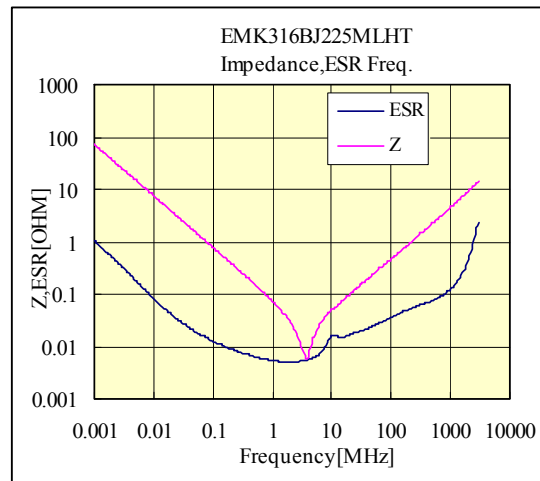
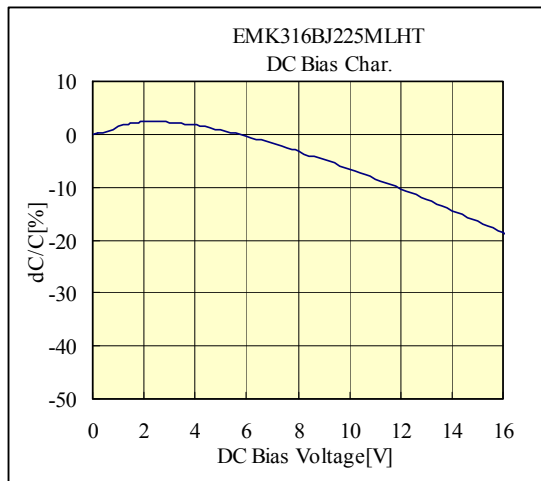
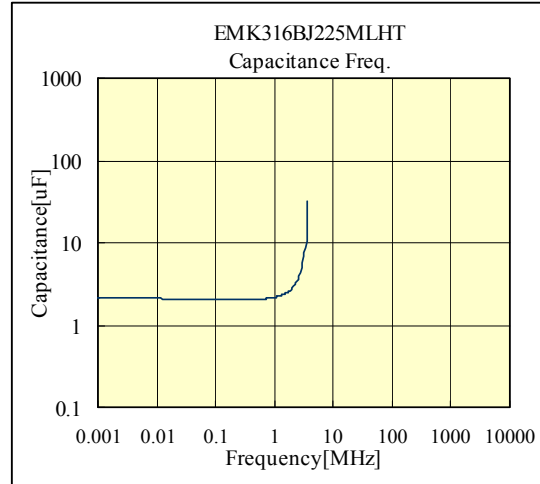
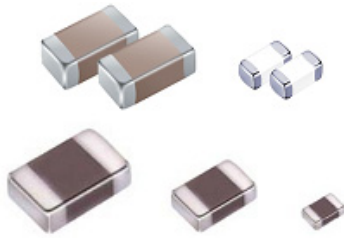

部品特性は設置環境、測定条件等により変化する場合があります。本データをご使用される際は実際の製品特性に対する参考データとしてご利用ください。また、本データは予告無く追加・削除及び変更を行う場合があります。ご注文の際は、納入仕様書のご確認をお願いします。

The data is reference only. Electrical characteristics vary depending on environment or measurement condition.

TAIYO YUDEN reserves the right to make change to the Date at any time without notice.

Before making final selection, please check product specification