



Chipsmall Limited consists of a professional team with an average of over 10 year of expertise in the distribution of electronic components. Based in Hongkong, we have already established firm and mutual-benefit business relationships with customers from,Europe,America and south Asia,supplying obsolete and hard-to-find components to meet their specific needs.

With the principle of “Quality Parts,Customers Priority,Honest Operation,and Considerate Service”,our business mainly focus on the distribution of electronic components. Line cards we deal with include Microchip,ALPS,ROHM,Xilinx,Pulse,ON,Everlight and Freescale. Main products comprise IC,Modules,Potentiometer,IC Socket,Relay,Connector.Our parts cover such applications as commercial,industrial, and automotives areas.

We are looking forward to setting up business relationship with you and hope to provide you with the best service and solution. Let us make a better world for our industry!



Contact us

Tel: +86-755-8981 8866 Fax: +86-755-8427 6832

Email & Skype: info@chipsmall.com Web: www.chipsmall.com

Address: A1208, Overseas Decoration Building, #122 Zhenhua RD., Futian, Shenzhen, China





“Three Fives” Discrete 555 Timer Kit

Re-create one of the most classic, popular, and all-around useful chips of all time.

v.2.0

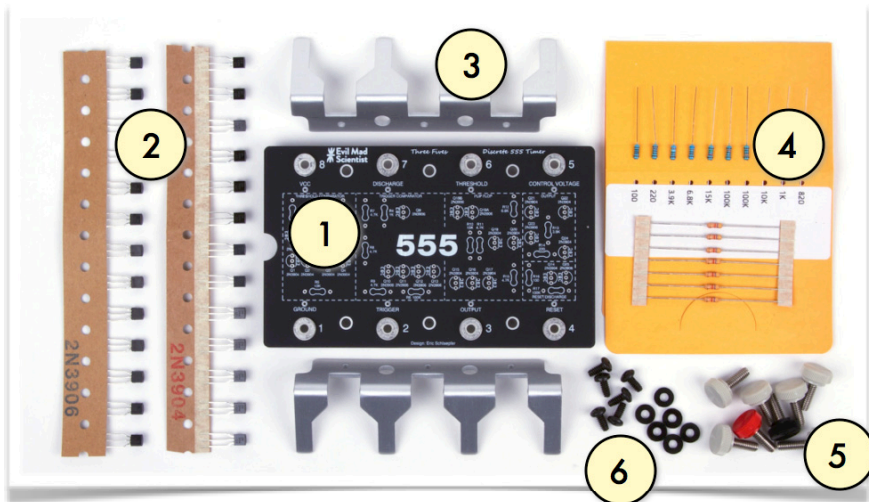

Kit Contents:

1. Circuit board with threaded inserts
2. Transistors:
 - 2N3904 (13 pcs.)
 - 2N3906 (13 pcs.)
3. Aluminum “IC Legs” stand (two halves)
4. Resistors:
 - 4.7 k (7 pcs.)
 - 10 others in resistor wallet
5. Thumbscrews with color-coded caps:
 - Gray (6 pcs.)
 - Red, Black (1 each)
6. Mounting screws & spacers for “IC Legs” stand (6 pcs. each)



Required Tools and Materials (not included with kit):

1. Soldering iron
Recommended: 25-50 W pencil type, e.g., Weller WLC100
2. Solder
Recommended: Rosin-core solder, 0.020 - 0.035” diameter
3. Small “flush” wire clippers
Recommended: Sears Craftsman #45660 diagonal cutting pliers
4. Phillips head screwdriver, “#2” size

How to Solder Components to the Circuit Board

0. For resistors only, pre-bend the leads as shown
1. Insert a component at its given location.
Push it down gently, as far as it will go.
(For resistors: flush. For transistors: not so flush.)
2. Gently bend its leads out, up to 45°, to hold it in place while you solder.
3. One at a time, from the back side, solder the leads of the component to the circuit board.
 - i. The tip of your iron needs to be shiny (tinned) for soldering to work well. If it isn't, melt some fresh solder against it and quickly swipe it clean against a wet sponge.
 - ii. Place the solder against the joint that you wish to connect.
 - iii. Touch the iron to the solder and joint for about one second.
Count it out: “one thousand one.”
 - iv. The solder should melt to the joint and leave a shiny wet-looking joint. If not, let it cool and try again.
4. From the bottom side, clip the excess leads, close to the board.
(But, not so close that you're clipping the board itself.)

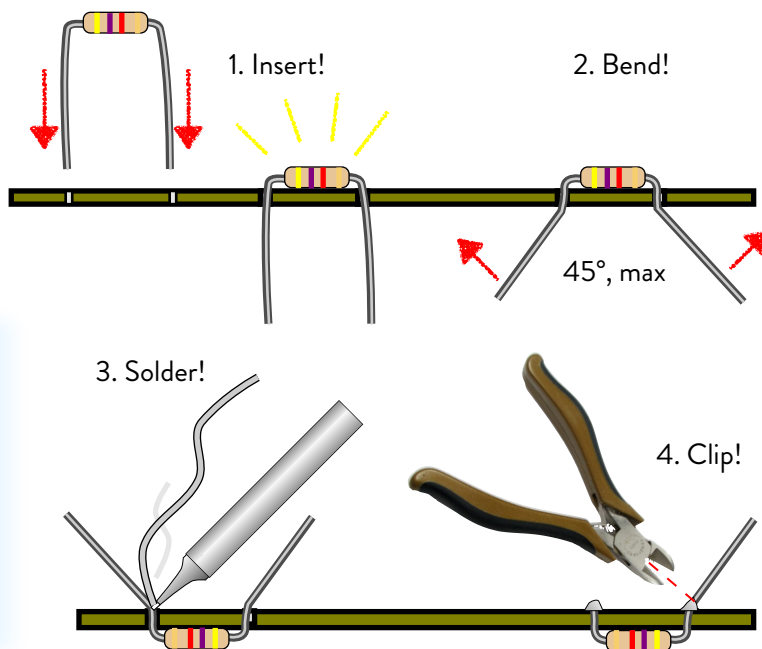

Assembly Step 1: Add the Resistors

1. Identify the seven 4.7 k resistors (color code: yellow, violet, red, gold)
2. The first 4.7 k resistor goes at location **R1**. Pre-bend its leads, insert it (either orientation), solder, and clip as described earlier (in “How to Solder Components to the Circuit Board”).
3. Install the other six 4.7 k resistors at **R3, R7, R8, R9, R11, and R15**.
4. Install the other 10 resistors, in the locations given by the table: 

Value	Color Code	Location(s)
820	gray, red, black, black, brown	R2
1 k	brown, black, black, brown, brown	R4
10 k	brown, black, black, red, brown	R5
100 k	brown, black, black, orange, brown	R6, R17
15 k	brown, green, black, red, brown	R10
6.8 k	blue, gray, black, brown, brown	R12
3.9 k	orange, white, black, brown, brown	R13
220	red, red, black, black, brown	R14
100	brown, black, black, black, brown	R16

Assembly Step 2: Add the Transistors

1. Identify the strip of thirteen 2N3904 transistors, and gently remove them from the tape.
2. Install the first 2N3904 transistor at location **Q1**. Transistor orientation is **very important**. Match the *flat face* of the transistor to the *flat face* of the drawing on the circuit board.
 - (Double check, please! Installing a transistor backwards is the most common assembly error!)
 Push the transistor in gently, as far as it will go, and then solder and clip its leads.
3. Install the remaining 2N3904 transistors at **Q2-4, Q14-18, Q20-22, and Q24**.
4. Install the 2N3906 transistors (the same way) at locations **Q5-13, Q19A, Q19B, Q23, and Q25**.

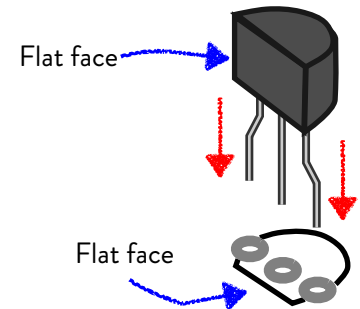

Assembly Step 3: Terminal Posts and Stand

1. Thread in the 8 thumbscrews (terminal posts) by hand:
 - Black: pin 1 (Ground). Red: pin 8 (Vcc). Gray: pins 2-7.
2. Install the first half of the “IC Legs” stand:
 - i. Hold the circuit board up on its side as shown. From the top side of the board, slip a black screw through each of the three screw holes between the thumbscrews. Then from the bottom side, slip one black plastic spacer over each of those screws.
 - ii. Move the first half of the anodized aluminum “IC Legs” stand into position and guide its three pilot holes onto the three black screws. Begin engaging the screws to trap the spacers in place.
 - iii. Alternating amongst the three, tighten the three screws until just firm; do not over-tighten.

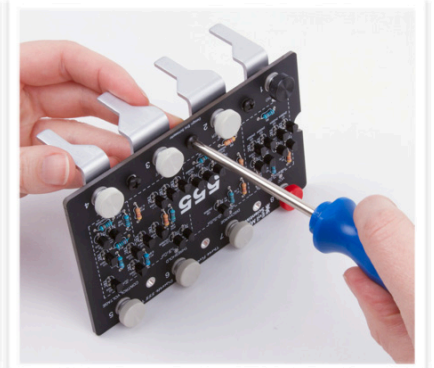
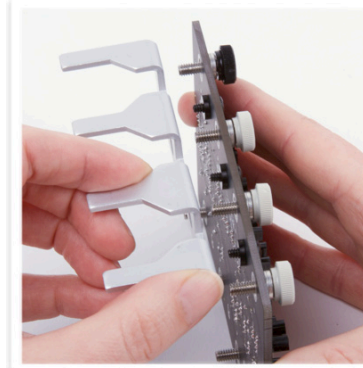

3. Repeat the same set of steps to install the second half of the stand. Once you have finished both sides, you may wish to momentarily loosen the screws slightly and straighten the stand with respect to the circuit board.

Testing and using your new 555 timer

- The “Three Fives” 555 timer can be used as a direct substitute for a 555 timer IC in most circuits. See the datasheet for specifications and more information. (Note that a previous version of this kit required an extra 100 kΩ resistor in some circuits. That resistor is now built in, as R17.)

- Suggested test circuit: 555 LED Blinker: 

- A good site for hundreds of other 555 projects is Talking Electronics: <http://tinyurl.com/555projects>

- You can read more about the kit and about the 555’s theory of operation on our wiki: Please visit: wiki.evilmadscientist.com/555

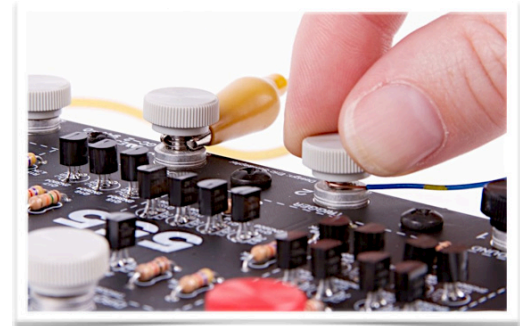
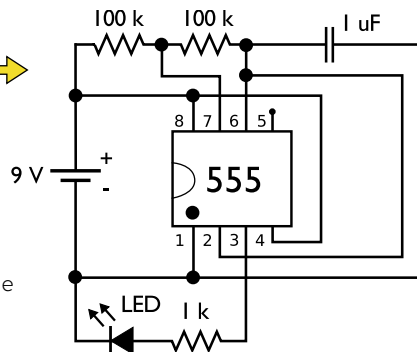

You can connect to the 555 through bare wire, alligator clips, or spade or ring lugs, using the terminal posts. You can also directly solder wires to the small pins next to each terminal post, if you’re careful to clip the wires such that they don’t touch the aluminum legs.