



Chipsmall Limited consists of a professional team with an average of over 10 year of expertise in the distribution of electronic components. Based in Hongkong, we have already established firm and mutual-benefit business relationships with customers from,Europe,America and south Asia,supplying obsolete and hard-to-find components to meet their specific needs.

With the principle of "Quality Parts,Customers Priority,Honest Operation,and Considerate Service",our business mainly focus on the distribution of electronic components. Line cards we deal with include Microchip,ALPS,ROHM,Xilinx,Pulse,ON,Everlight and Freescale. Main products comprise IC,Modules,Potentiometer,IC Socket,Relay,Connector.Our parts cover such applications as commercial,industrial, and automotives areas.

We are looking forward to setting up business relationship with you and hope to provide you with the best service and solution. Let us make a better world for our industry!



## Contact us

Tel: +86-755-8981 8866 Fax: +86-755-8427 6832

Email & Skype: info@chipsmall.com Web: www.chipsmall.com

Address: A1208, Overseas Decoration Building, #122 Zhenhua RD., Futian, Shenzhen, China





**Specifications**

Output voltage	9 V ac at 2000 mA	
Rated input voltage	120 V ac	
Primary rated voltage	120 V ac 60 Hz 23 W	
Primary exciting current	30 mA rms max.	
Secondary rated voltage & current	no load voltage (max.)	11.1 V ref
	full load voltage (2000 mA)	9 V $\pm$ 5%
Temperature rise of primary winding (full load)	70°C max. using resistance method	
Insulation resistance	$\geq$ 100 M Ohm at 500 V dc	
HI-POT test	from input to output for 1 min.	1240 V ac at 2 mA
	from input to output for 1 sec.	1600 V ac at 2 mA
	from primary to secondary winding for 1 sec.	1600 V ac at 2 mA
	from primary winding to core for 1 sec.	1600 V ac at 2 mA
	from secondary winding to core for 1 sec.	750 V ac at 2 mA
Safety standards	UL/cUL	
RoHS compliant	yes	
No load power consumption	0.5 W max.	
Efficiency	Energy Star Compliant - Efficiency Level IV	
Test conditions	Ambient temp	40°C $\pm$ 2°C
	Humidity	90-95% 96 hours at Full Load
	Rated voltage	8 hours at full load
Adapter color	Case	black
	Cord	black

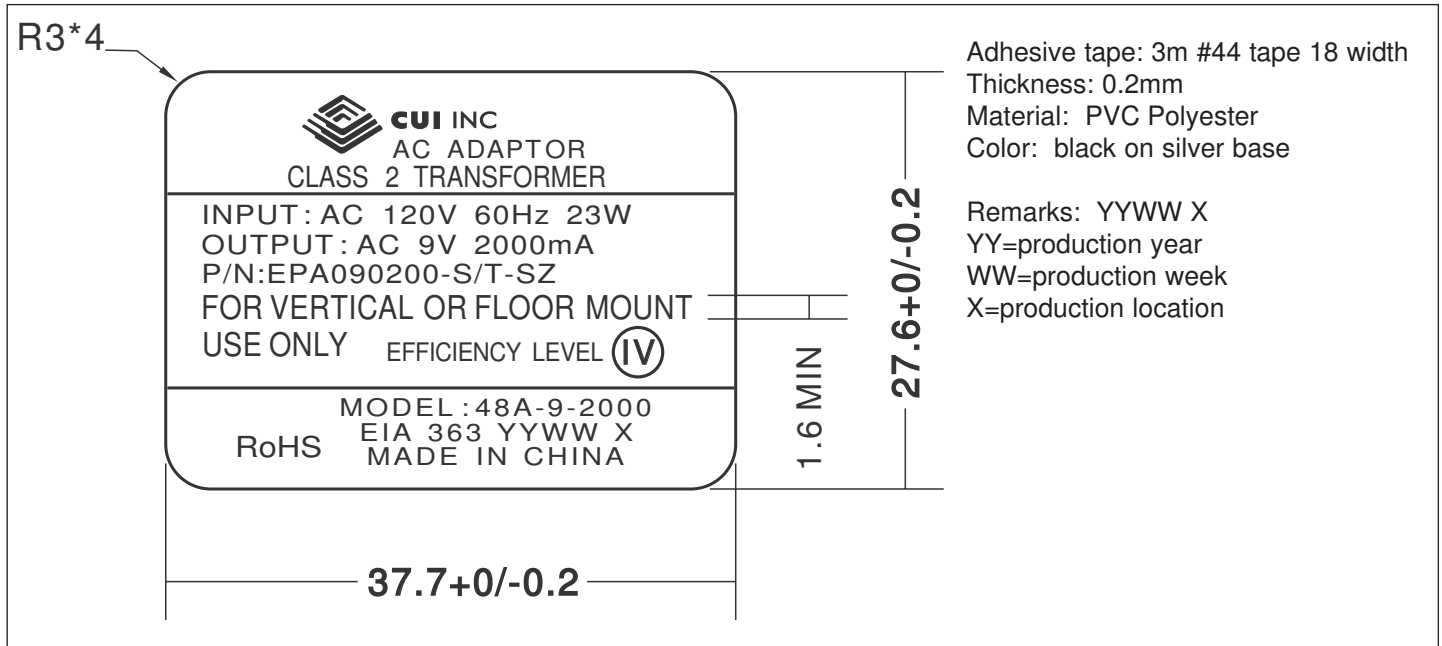

**Label**



**Mechanical Drawing**

 Tolerance:  $\pm 1$ 

Weight

520 g

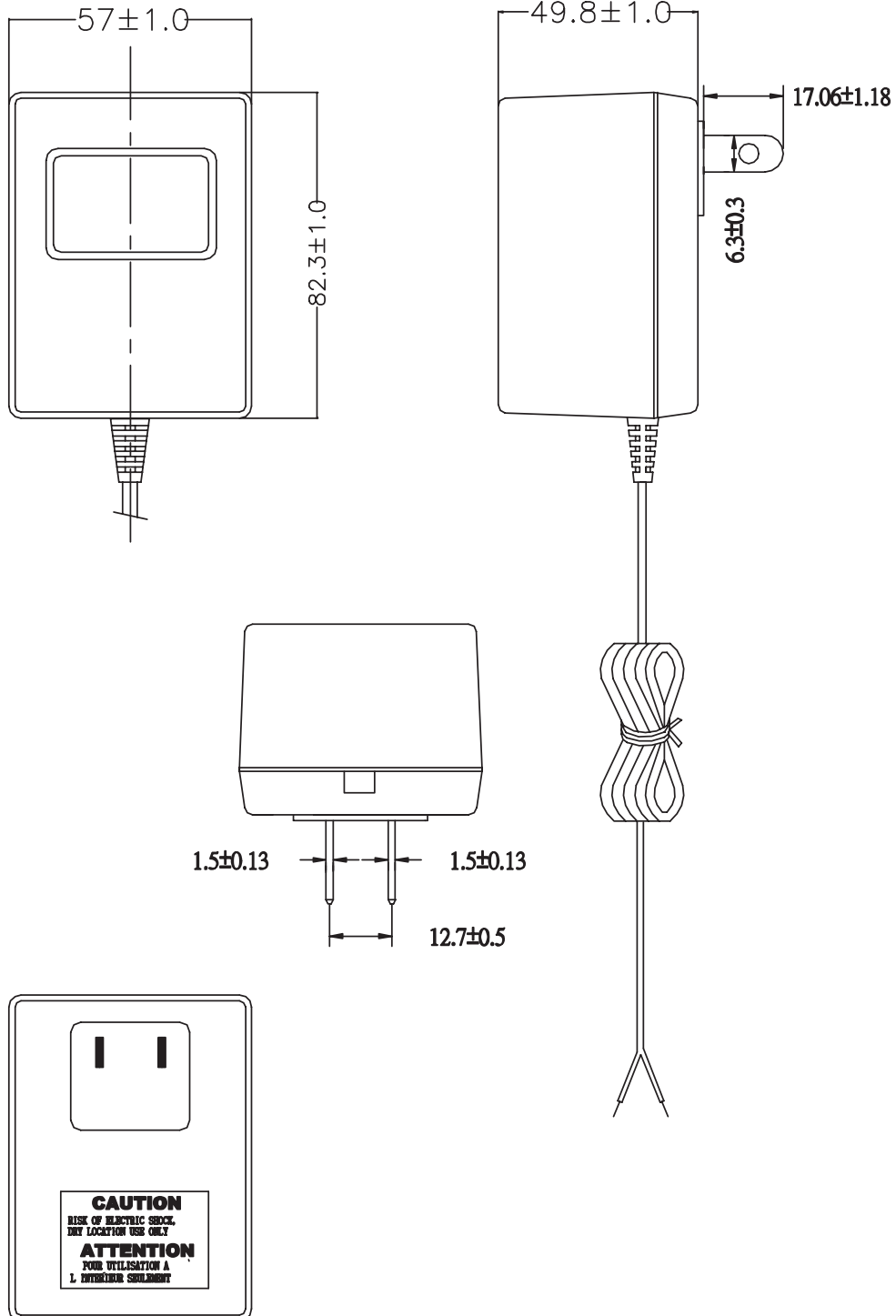



DC Cord

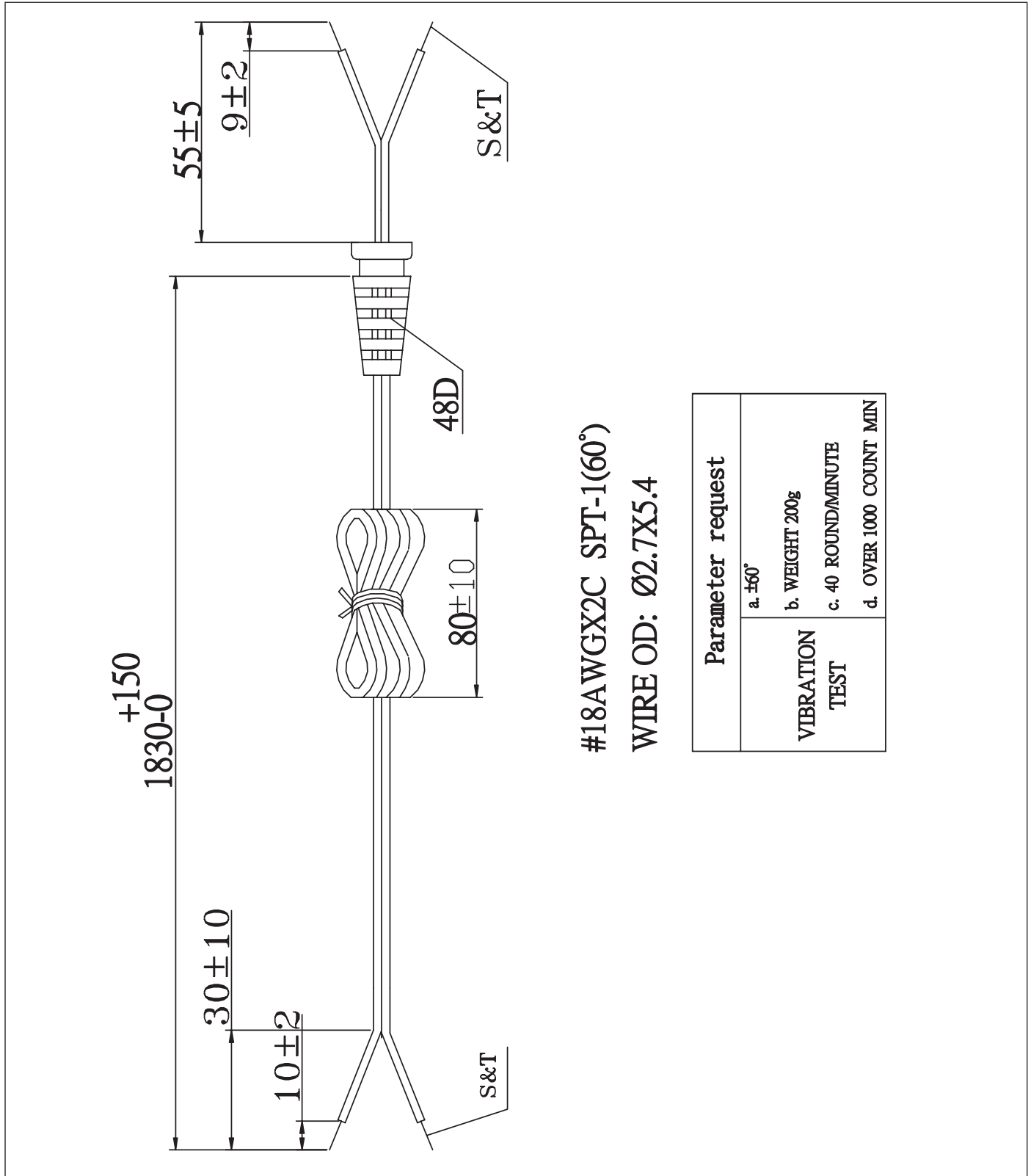

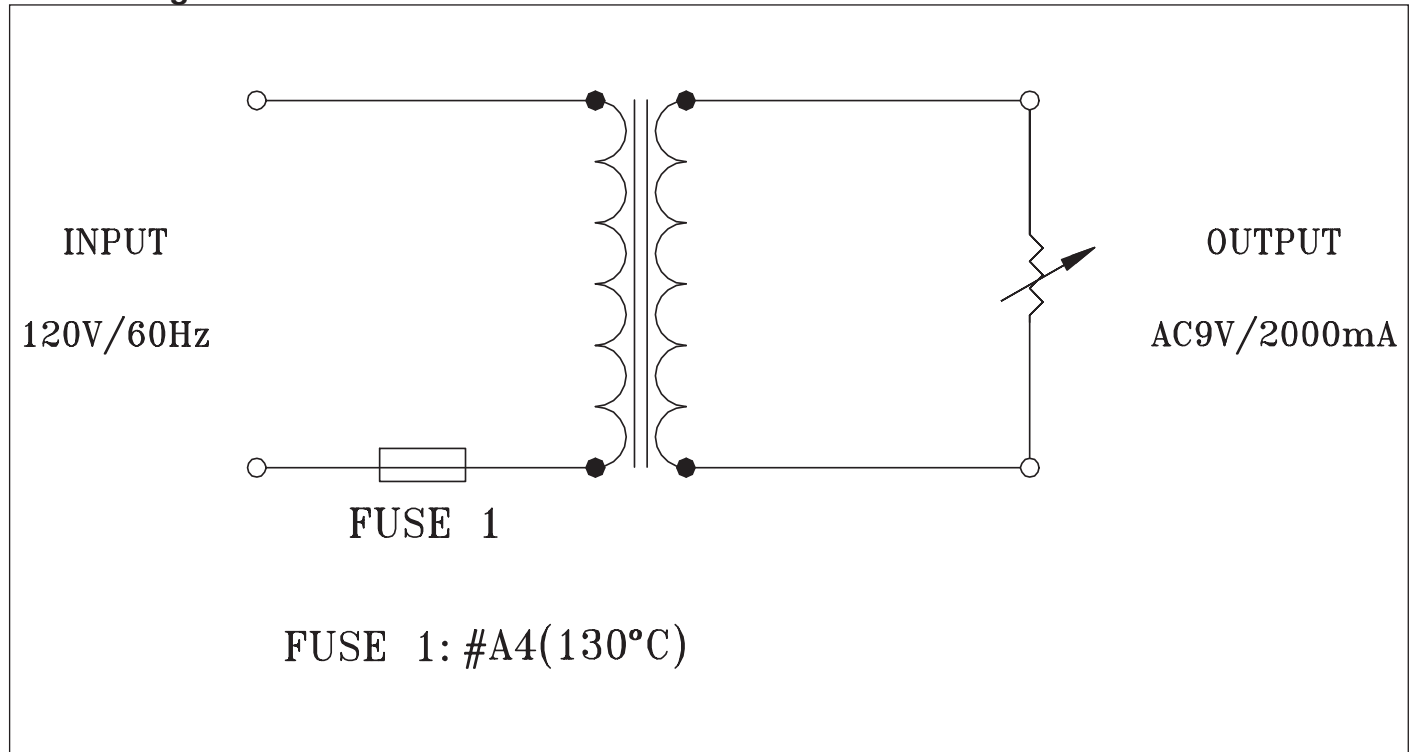
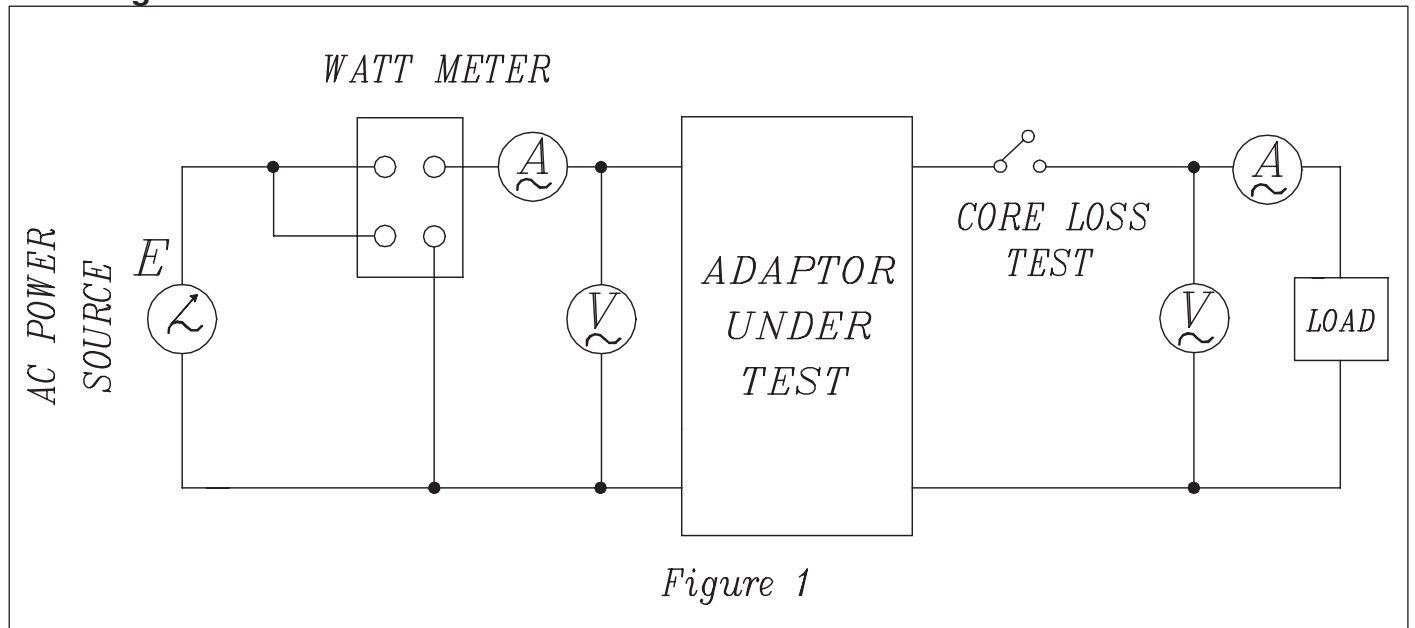
**Circuit Diagrams**

**Test Diagram**

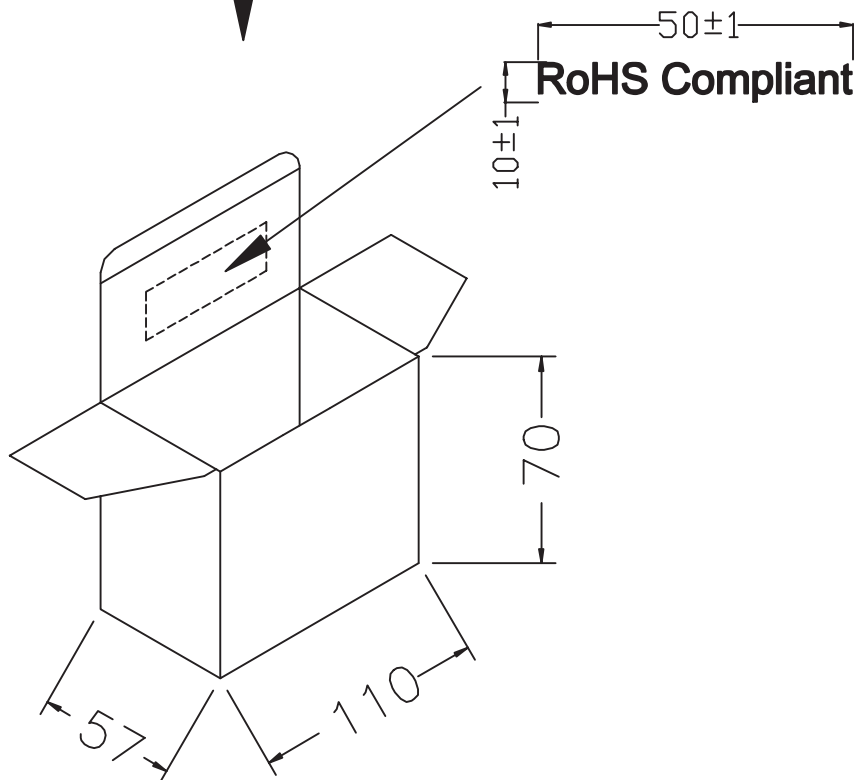
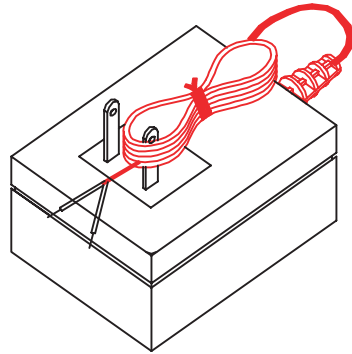

**Individual Packaging**

Tolerance:  $\pm 1$





**Packaging**

Tolerance: +7/-0

CARTON SIZE: 377X355X147mm

Q'TY: 30pcs(15x2)

N.W:15.6KGS

G.W:16.6KGS

G.W:17.1KGS

