



Chipsmall Limited consists of a professional team with an average of over 10 year of expertise in the distribution of electronic components. Based in Hongkong, we have already established firm and mutual-benefit business relationships with customers from,Europe,America and south Asia,supplying obsolete and hard-to-find components to meet their specific needs.

With the principle of “Quality Parts,Customers Priority,Honest Operation,and Considerate Service”,our business mainly focus on the distribution of electronic components. Line cards we deal with include Microchip,ALPS,ROHM,Xilinx,Pulse,ON,Everlight and Freescale. Main products comprise IC,Modules,Potentiometer,IC Socket,Relay,Connector.Our parts cover such applications as commercial,industrial, and automotives areas.

We are looking forward to setting up business relationship with you and hope to provide you with the best service and solution. Let us make a better world for our industry!



Contact us

Tel: +86-755-8981 8866 Fax: +86-755-8427 6832

Email & Skype: info@chipsmall.com Web: www.chipsmall.com

Address: A1208, Overseas Decoration Building, #122 Zhenhua RD., Futian, Shenzhen, China



EPC2007C – Enhancement Mode Power Transistor

 V_{DSS} , 100 V $R_{DS(on)}$, 30 mΩ I_D , 6 A

NEW PRODUCT

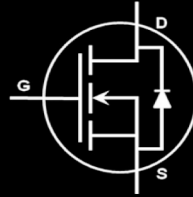

RoHS



Halogen-Free

Gallium Nitride is grown on Silicon Wafers and processed using standard CMOS equipment leveraging the infrastructure that has been developed over the last 55 years. GaN's exceptionally high electron mobility and low temperature coefficient allows very low $R_{DS(on)}$, while its lateral device structure and majority carrier diode provide exceptionally low Q_G and zero Q_{RR} . The end result is a device that can handle tasks where very high switching frequency, and low on-time are beneficial as well as those where on-state losses dominate.

Maximum Ratings

V_{DS}	Drain-to-Source Voltage (Continuous)	100	V
I_D	Continuous ($T_A = 25^\circ\text{C}$, $R_{\theta JA} = 62^\circ\text{C/W}$)	6	A
	Pulsed (25°C , $T_{Pulse} = 300\ \mu\text{s}$)	40	
V_{GS}	Gate-to-Source Voltage	6	V
	Gate-to-Source Voltage	-4	
T_J	Operating Temperature	-40 to 150	$^\circ\text{C}$
T_{STG}	Storage Temperature	-40 to 150	

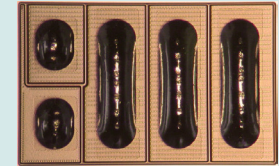

EPC2007C eGaN® FETs are supplied only in passivated die form with solder bumps

Applications

- High Speed DC-DC conversion
- Class-D Audio
- High Frequency Hard-Switching and Soft-Switching Circuits

Benefits

- Ultra High Efficiency
- Ultra Low $R_{DS(on)}$
- Ultra low Q_G
- Ultra small footprint

www.epc-co.com/epc/Products/eGaNfets/EPC2007C.aspx

Static Characteristics ($T_J = 25^\circ\text{C}$ unless otherwise stated)

PARAMETER	TEST CONDITIONS	MIN	TYP	MAX	UNIT	
BV_{DSS}	Drain-to-Source Voltage	$V_{GS} = 0\text{ V}$, $I_D = 75\ \mu\text{A}$	100		V	
I_{DSS}	Drain Source Leakage	$V_{DS} = 80\text{ V}$, $V_{GS} = 0\text{ V}$	20	60	μA	
I_{GSS}	Gate-to-Source Forward Leakage	$V_{GS} = 5\text{ V}$	0.25	2	mA	
	Gate-to-Source Reverse Leakage	$V_{GS} = -4\text{ V}$	20	60	μA	
$V_{GS(TH)}$	Gate Threshold Voltage	$V_{DS} = V_{GS}$, $I_D = 1.2\text{ mA}$	0.8	1.4	2.5	V
$R_{DS(on)}$	Drain-Source On Resistance	$V_{GS} = 5\text{ V}$, $I_D = 6\text{ A}$	24	30	mΩ	
V_{SD}	Source-Drain Forward Voltage	$I_S = 0.5\text{ A}$, $V_{GS} = 0\text{ V}$	2.1		V	

All measurements were done with substrate shorted to source.

Thermal Characteristics

		TYP	UNIT
$R_{\theta JC}$	Thermal Resistance, Junction to Case	3.6	$^\circ\text{C/W}$
$R_{\theta JB}$	Thermal Resistance, Junction to Board	9.3	$^\circ\text{C/W}$
$R_{\theta JA}$	Thermal Resistance, Junction to Ambient (Note 1)	80	$^\circ\text{C/W}$

Note 1: $R_{\theta JA}$ is determined with the device mounted on one square inch of copper pad, single layer 2 oz copper on FR4 board. See http://epc-co.com/epc/documents/product-training/Appnote_Thermal_Performance_of_eGaN_FETs.pdf for details.

Dynamic Characteristics (T_J = 25°C unless otherwise stated)

PARAMETER		TEST CONDITIONS	MIN	TYP	MAX	UNIT
C _{ISS}	Input Capacitance	V _{DS} = 50 V, V _{GS} = 0 V		170	220	pF
C _{OSS}	Output Capacitance			110	165	
C _{RSS}	Reverse Transfer Capacitance			1.9	2.7	
R _G	Gate Resistance			0.4		Ω
Q _G	Total Gate Charge	V _{DS} = 50 V, V _{GS} = 5 V, I _D = 6 A		1.6	2.2	nC
Q _{GS}	Gate-to-Source Charge	V _{DS} = 50 V, I _D = 6 A		0.6		
Q _{GD}	Gate-to-Drain Charge			0.3	0.6	
Q _{G(TH)}	Gate Charge at Threshold			0.4		
Q _{OSS}	Output Charge	V _{DS} = 50 V, V _{GS} = 0 V		8.3	12.5	
Q _{RR}	Source-Drain Recovery Charge			0		

All measurements were done with substrate shorted to source.

Figure 1: Typical Output Characteristics at 25 °C

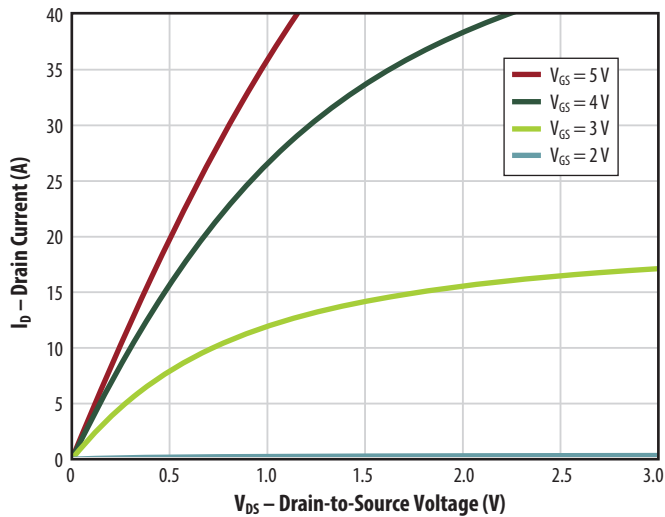

Figure 2: Transfer Characteristics

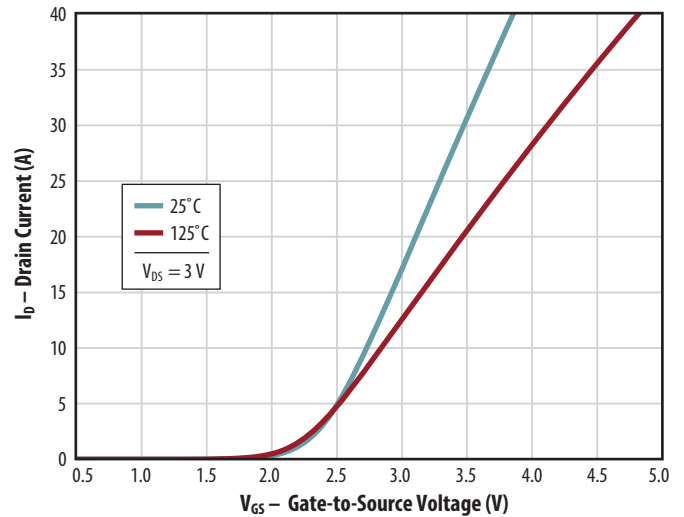

Figure 3: R_{DS(on)} vs. V_{GS} for Various Drain Currents

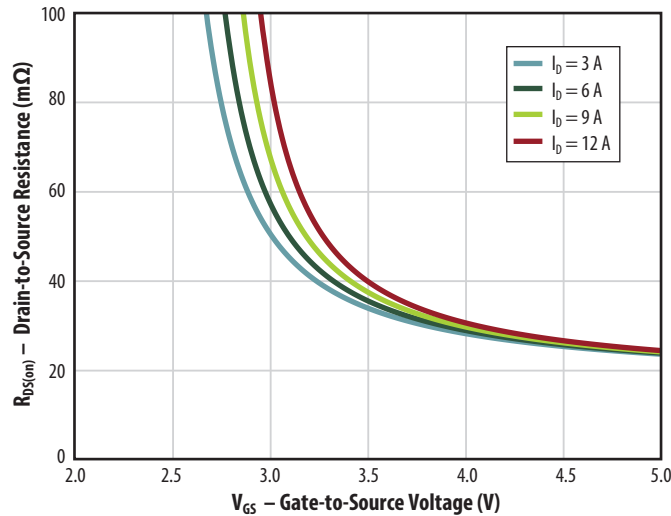

Figure 4: R_{DS(on)} vs. V_{GS} for Various Temperatures

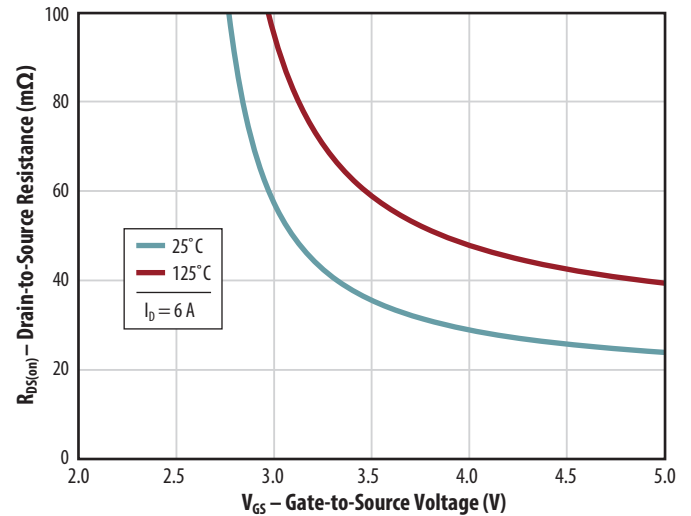

Figure 5a: Capacitance (Linear Scale)

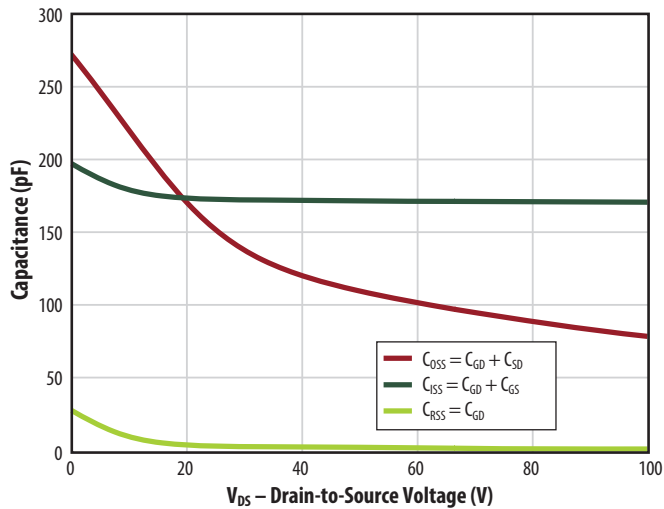

Figure 5b: Capacitance (Log Scale)

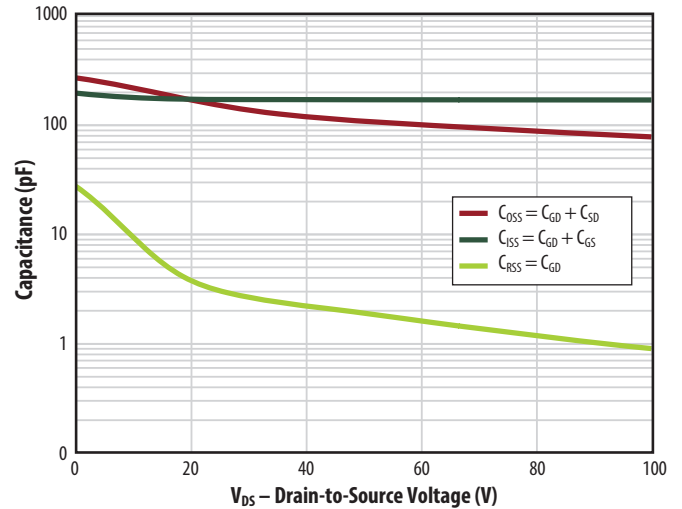

Figure 6: Gate Charge

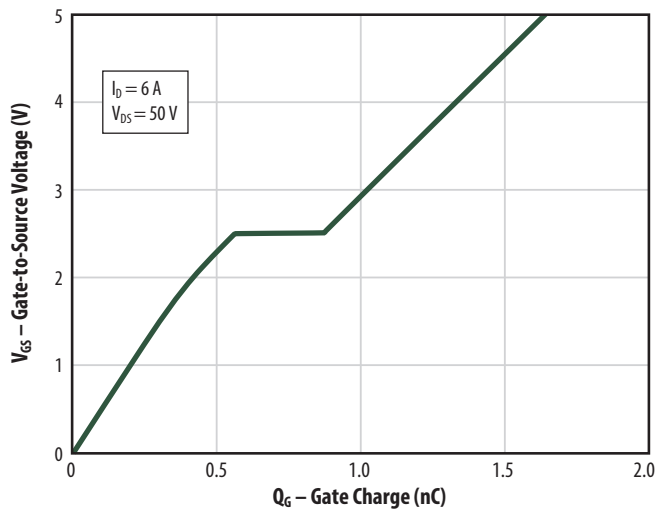

Figure 7: Reverse Drain-Source Characteristics

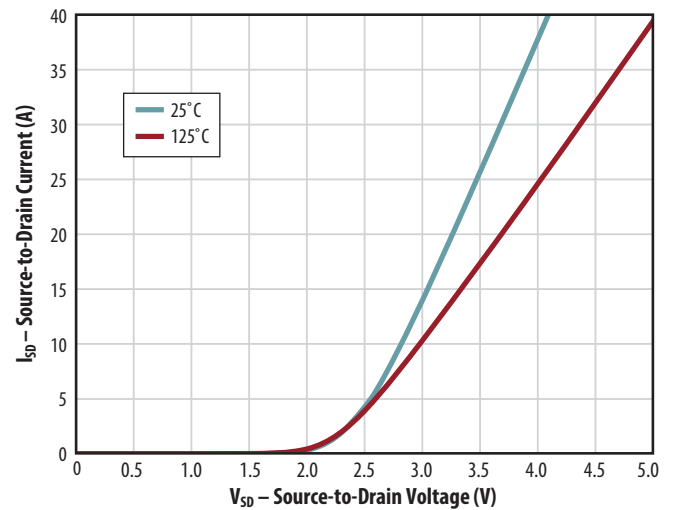

Figure 8: Normalized On-State Resistance vs. Temperature

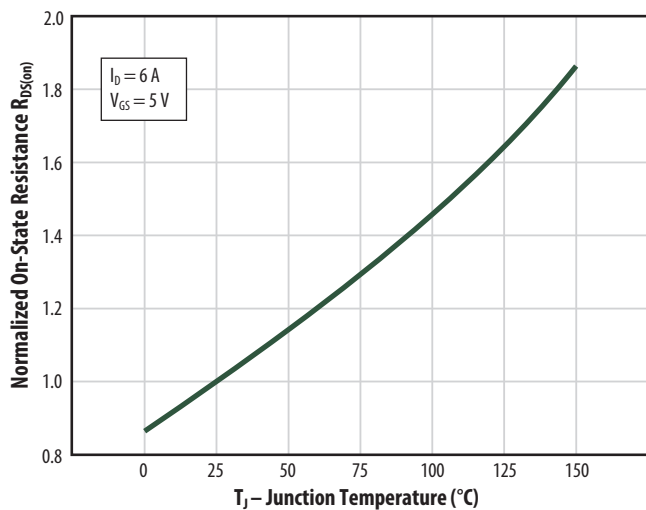
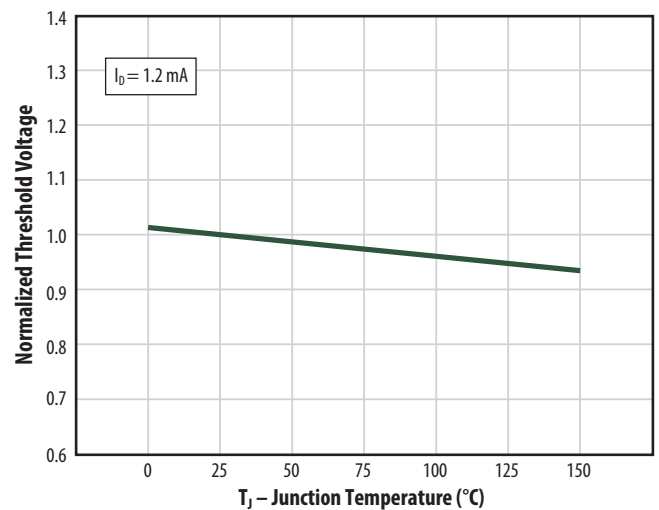

Figure 9: Normalized Threshold Voltage vs. Temperature



All measurements were done with substrate shorted to source.

Figure 10: Gate Leakage Current

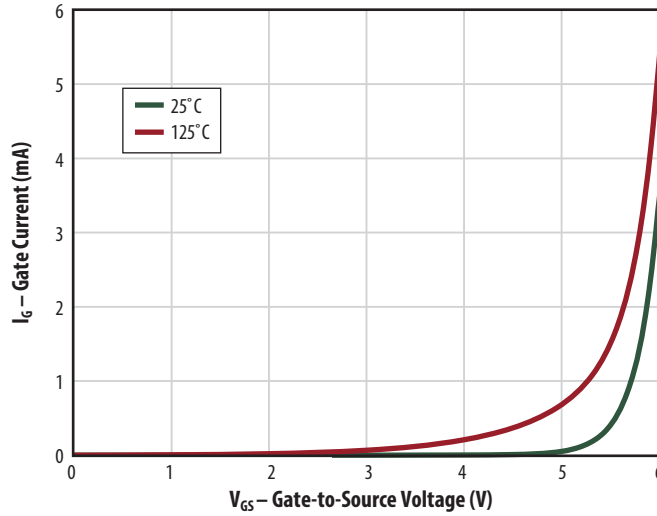

Figure 11: Transient Thermal Response Curves

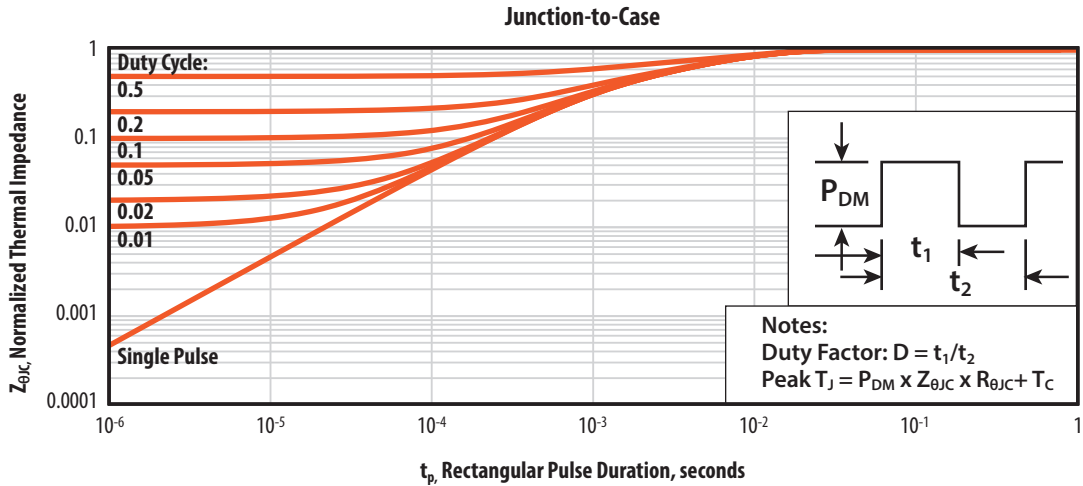
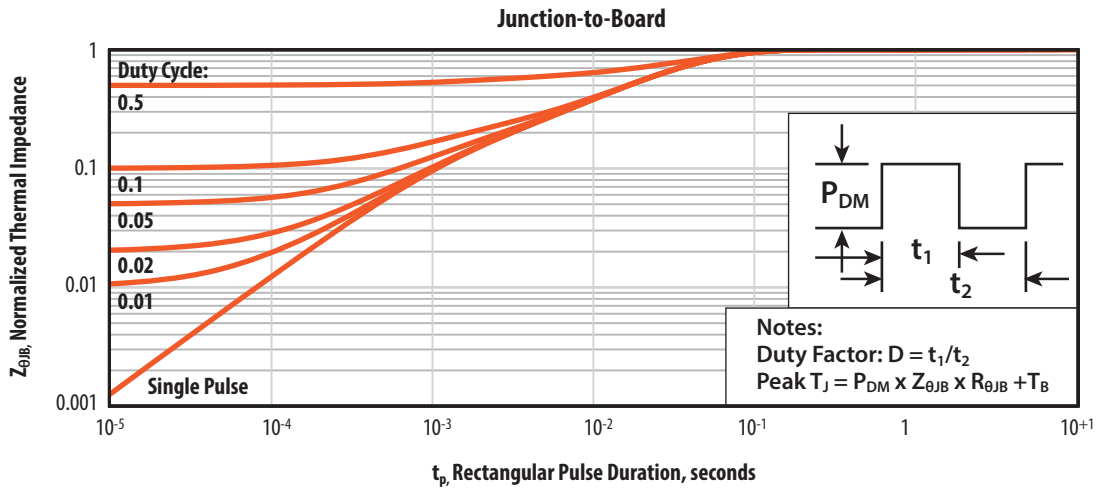
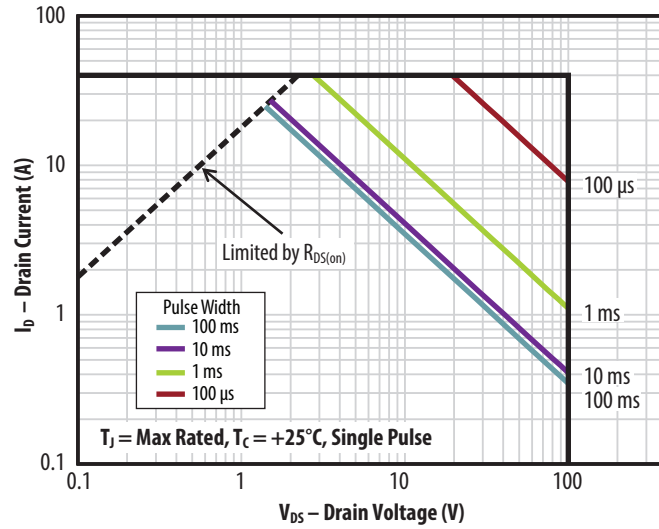
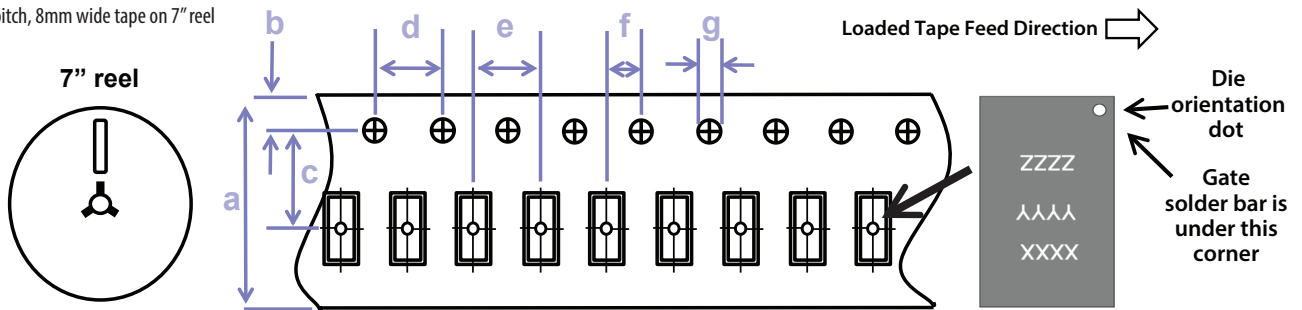

Figure 12: Safe Operating Area



TAPE AND REEL CONFIGURATION

4mm pitch, 8mm wide tape on 7" reel



Die is placed into pocket solder bar side down (face side down)

	EPC2007C (note 1)		
Dimension (mm)	target	min	max
a	8.00	7.90	8.30
b	1.75	1.65	1.85
c (see note)	3.50	3.45	3.55
d	4.00	3.90	4.10
e	4.00	3.90	4.10
f (see note)	2.00	1.95	2.05
g	1.5	1.5	1.6

Note 1: MSL 1 (moisture sensitivity level 1) classified according to IPC/JEDEC industry standard.
 Note 2: Pocket position is relative to the sprocket hole measured as true position of the pocket, not the pocket hole.

DIE MARKINGS

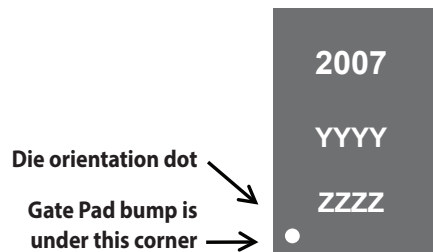

Part Number	Laser Markings		
	Part # Marking Line 1	Lot_Date Code Marking line 2	Lot_Date Code Marking Line 3
EPC2007C	2007	YYYY	ZZZZ

DIE OUTLINE

Solder Bar View

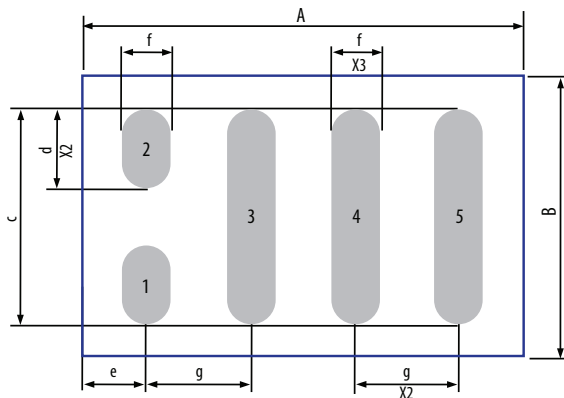

Side View

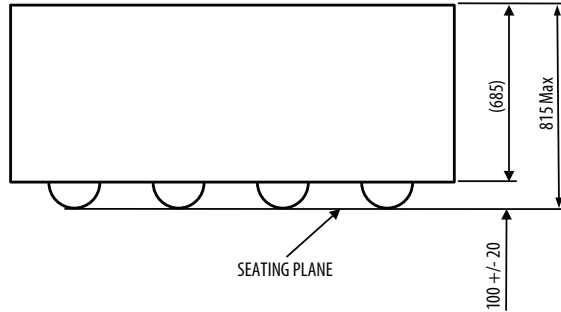

DIM	MICROMETERS		
	MIN	Nominal	MAX
A	1672	1702	1732
B	1057	1087	1117
c	834	837	840
d	327	330	333
e	235	250	265
f	195	200	205
g	400	400	400

RECOMMENDED LAND PATTERN

(measurements in μm)

The land pattern is solder mask defined
Solder mask is 10 μm smaller per side than bump

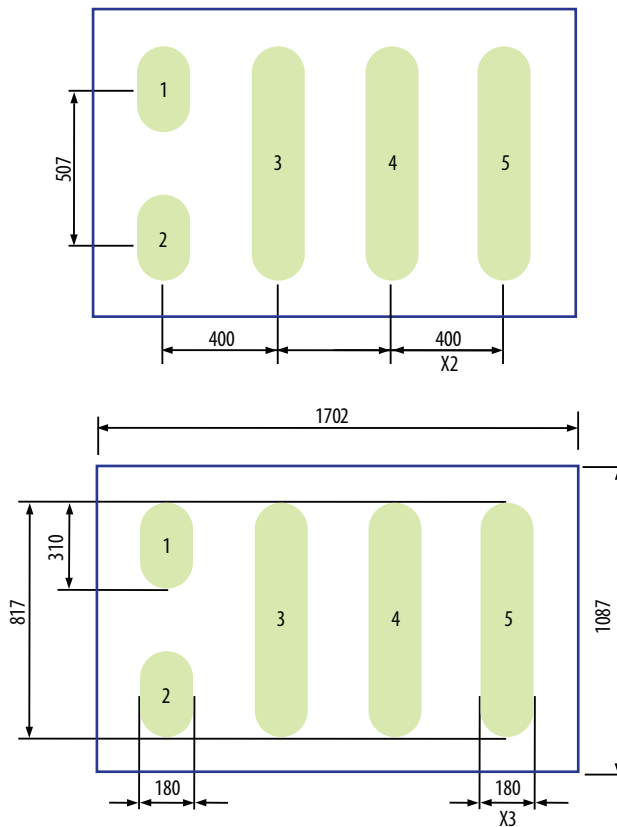

- Pad no. 1 is Gate
- Pad no. 2 is Substrate
- Pad no. 3 and 5 are Drain
- Pad no. 4 is Source

For assembly recommendations please visit <http://epc-co.com/epc/DesignSupport/AssemblyBasics.aspx>

Efficient Power Conversion Corporation (EPC) reserves the right to make changes without further notice to any products herein to improve reliability, function or design. EPC does not assume any liability arising out of the application or use of any product or circuit described herein; neither does it convey any license under its patent rights, nor the rights of others.

eGaN® is a registered trademark of Efficient Power Conversion Corporation.
U.S. Patents 8,350,294; 8,404,508; 8,431,960; 8,436,398

Information subject to change without notice.
revised January, 2015