



Chipsmall Limited consists of a professional team with an average of over 10 year of expertise in the distribution of electronic components. Based in Hongkong, we have already established firm and mutual-benefit business relationships with customers from,Europe,America and south Asia,supplying obsolete and hard-to-find components to meet their specific needs.

With the principle of “Quality Parts,Customers Priority,Honest Operation,and Considerate Service”,our business mainly focus on the distribution of electronic components. Line cards we deal with include Microchip,ALPS,ROHM,Xilinx,Pulse,ON,Everlight and Freescale. Main products comprise IC,Modules,Potentiometer,IC Socket,Relay,Connector.Our parts cover such applications as commercial,industrial, and automotives areas.

We are looking forward to setting up business relationship with you and hope to provide you with the best service and solution. Let us make a better world for our industry!



Contact us

Tel: +86-755-8981 8866 Fax: +86-755-8427 6832

Email & Skype: info@chipsmall.com Web: www.chipsmall.com

Address: A1208, Overseas Decoration Building, #122 Zhenhua RD., Futian, Shenzhen, China



ER-F SERIES

Related Information

- General terms and conditions..... F-7
- Selection guide P.1157~
- Glossary of terms..... P.1497
- General precautions P.1501



panasonic.net/id/pidsx/global

A compact shape for reducing workbench clutter

Compact size of 150 × 166 × 62 mm (5.906 × 6.535 × 2.441 in)
Low-volume fan type also available for various applications

An ionizer with a 120 mm **4.724 in** fan diameter that has a class leading compact size for reducing workbench clutter and increasing efficiency.

Low-volume fan type with a suppressed fan speed of approx. half is available for charge removal in processes which involve handling of small parts or thin films.

* Graphs represent typical values at 300 mm **11.811 in** from directly in front of air outlet, straight louver, with no filter installed.

Standard fan type ER-F12

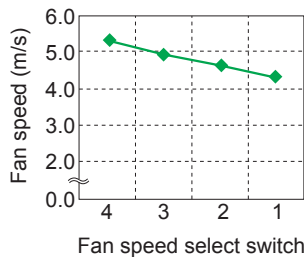

Low-volume fan type ER-F12S

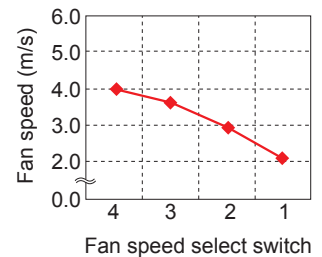

Two exchangeable louvers to suit your needs

Just simply replace the louver to change configuration between long distance and wide area ionization.

The two louvers come with the ionizer main body.

Straight louver



Removes charges quickly at long distance

Angle louver



Removes charges completely in wide area

- FIBER SENSORS
- LASER SENSORS
- PHOTOELECTRIC SENSORS
- MICRO PHOTOELECTRIC SENSORS
- AREA SENSORS
- LIGHT CURTAINS / SAFETY COMPONENTS
- PRESSURE / FLOW SENSORS
- INDUCTIVE PROXIMITY SENSORS
- PARTICULAR USE SENSORS
- SENSOR OPTIONS
- SIMPLE WIRE-SAVING UNITS
- WIRE-SAVING SYSTEMS
- MEASUREMENT SENSORS
- STATIC ELECTRICITY PREVENTION DEVICES

- LASER MARKERS
- PLC
- HUMAN MACHINE INTERFACES
- ENERGY CONSUMPTION VISUALIZATION COMPONENTS
- FA COMPONENTS
- MACHINE VISION SYSTEMS
- UV CURING SYSTEMS

- Selection Guide
- Static Removers
- Cleaning Box
- Pulse Air-gun
- Electrostatic Sensor

- ER-X
- ER-TF
- ER-VS02
- ER-VW
- ER-Q
- ER-F

Remove the louver for effortless maintenance

Because the discharge needle unit is attached to the louver, exchange or maintenance of the needles is made easy without touching the main unit. A safe design where once the louver is removed, the high-voltage circuit and the fan will halt.

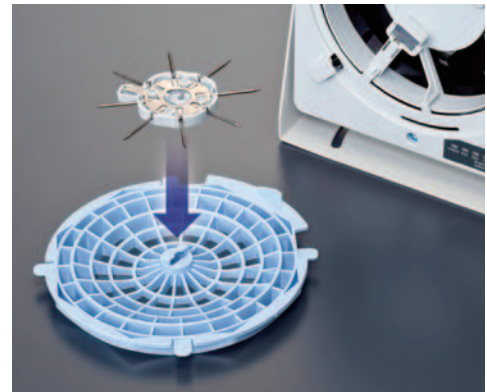

ORDER GUIDE

Type	Appearance	Charge removal time (±1,000 V → ±100 V)	Ion balance	Model No.
Standard fan type		1 sec. approx. (Note 1)	±10 V or less (Note 2)	ER-F12
Low-volume fan type		1.5 sec. approx. (Note 1)		ER-F12S

Notes: 1) Typical value at 200 mm **7.874 in** from directly in front of air outlet, fan speed MAX, straight louver, with no filter installed.

2) Typical value at 300 mm **11.811 in** from directly in front of air outlet, fan speed MAX, straight louver, with no filter installed.

OPTIONS

Type	Model No.	Description
AC adapter	ER-FAPS-J2	IN: 100 to 240 V AC 50 / 60 Hz OUT: 24 V DC, 1.5 A
	ER-FAPS-EX (Note)	Cable length between connector and AC adaptor: 1.8 m 5.905 ft AC cable: 125 V rated (an accessory to ER-FAPS-J2 only)
Discharge needle unit	ER-F12ANT	Unit with tungsten needles (1 pc.)
Air filter	ER-F12FX5	Replacement filter (5 pcs. per set)

Note: Please prepare an AC cable separately as it is needed.



Inlet configuration (IEC 60320-C13)

APPLICATIONS

Prevention of static charge in cell production

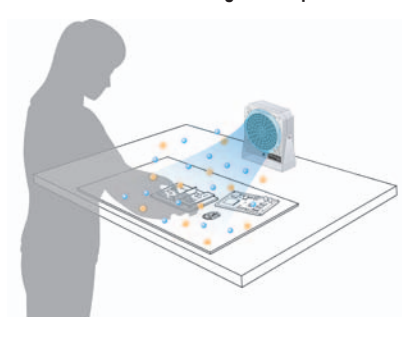

FIBER SENSORS

LASER SENSORS

PHOTO-ELECTRIC SENSORS

MICRO PHOTO-ELECTRIC SENSORS

AREA SENSORS

LIGHT CURTAINS / SAFETY COMPONENTS

PRESSURE / FLOW SENSORS

INDUCTIVE PROXIMITY SENSORS

PARTICULAR USE SENSORS

SENSOR OPTIONS

SIMPLE WIRE-SAVING UNITS

WIRE-SAVING SYSTEMS

MEASUREMENT SENSORS

STATIC ELECTRICITY PREVENTION DEVICES

LASER MARKERS

PLC

HUMAN MACHINE INTERFACES

ENERGY CONSUMPTION VISUALIZATION COMPONENTS

FA COMPONENTS

MACHINE VISION SYSTEMS

UV CURING SYSTEMS

Selection Guide

Static Removers

Cleaning Box

Pulse Air-gun

Electrostatic Sensor

ER-X

ER-TF

ER-VS02

ER-VW

ER-Q

ER-F

SPECIFICATIONS

Type	Standard fan type	Low-volume fan type
Item	ER-F12	ER-F12S
Charge removal time (±1,000 V → ±100 V)	1 sec. approx. (Note 2)	1.5 sec. approx. (Note 2)
Ion balance	±10 V or less (Note 3)	
Power supply voltage	24 V DC ±10 %	
Power consumption	700 mA or less	400 mA or less
Discharge method	High-frequency AC method	
Discharge output voltage	± 2 kV approx.	
Max. fan speed	5.3 m/s (Note 3)	4.0 m/s (Note 3)
Max. fan volume	3.68 m³/min	2.50 m³/min
Error output	NPN open-collector transistor • Max sink current: 50 mA • Applied voltage: 30 V DC or less (between output terminal and 0 V) • Residual voltage: 1 V or less (at input current of 50 mA)	
Output operation	OFF when discharge error or fan error detected Normally ON	
Short-circuit protection	Incorporated	
Discharge halt input	Discharge halt: Short-circuited to 0 V Discharge (operation start): Open	
Indicators	Discharge error (Red), Fan error (Red), Power (Green), Discharge (Green)	
Ozone generation amount	0.04 ppm or less (Note 2)	
Ambient temperature	0 to +50°C +32 to +122°F (No dew condensation) , Storage: -10 to +65°C +14 to +149°F	
Ambient humidity	35 to 65% RH (No dew condensation) , Storage: 35 to 65% RH	
Grounding method	C (capacitor) grounding	
Material	Enclosure: ABS, Louver: ABS, Discharge needle unit: PBT, Discharge needle: Tungsten, Bracket: SPHC	
Weight	4 Main unit: 790 g approx.	
Accessories	Straight louver: 1 pc. (Note 4), Angle louver: 1 pc., Caution label: 1 set, Rubber cushion: 1 pc.	

Notes: 1) Where measurement conditions have not been specified precisely, the conditions used were an ambient temperature of +20 °C **+68 °F**.
 2) Typical value at 200 mm **7.874 in** from directly in front of air outlet, fan speed MAX, straight louver, with no filter installed.
 3) Typical value at 300 mm **11.811 in** from directly in front of air outlet, fan speed MAX, straight louver, with no filter installed.
 4) The discharge needle unit is loaded on the straight louver before shipment.

I/O CIRCUIT AND WIRING DIAGRAMS

I/O circuit diagram

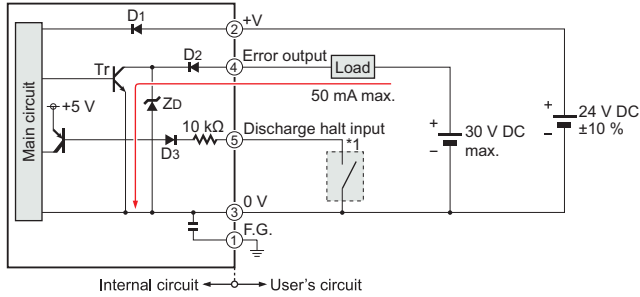

* 1
 Non-voltage contact or NPN open-collector transistor
 Low (0 V): Discharge halt
 High (Open): Discharge (Operation starts)

Symbols ... D1 : Reverse supply polarity protection diode
 D2 : Output protection diode
 D3 : Input protection diode
 Zd : Surge absorption zener diode
 Tr : NPN output transistor

Connector terminal arrangement

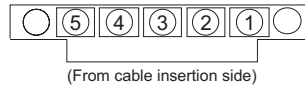

Terminal No.	Color code
①	F.G.
②	+V
③	0 V
④	Error output
⑤	Discharge halt input

Recommended wiring cable

Compatible wire: 25 AWG to 12 AWG (nominal cross-sectional area: 0.16 to 3.3 mm²)
 Wire stripping length: 7 mm (see below)

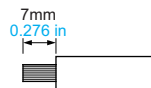

Note: Do not solder-plate the ends of wires being connected to connectors. Doing so may result in loosening of tightened screws, causing the wire to come loose.

FIBER SENSORS
 LASER SENSORS
 PHOTO-ELECTRIC SENSORS
 MICRO PHOTO-ELECTRIC SENSORS
 AREA SENSORS
 LIGHT CURTAINS / SAFETY COMPONENTS
 PRESSURE / FLOW SENSORS
 INDUCTIVE PROXIMITY SENSORS
 PARTICULAR USE SENSORS
 SENSOR OPTIONS
 SIMPLE WIRE-SAVING UNITS
 WIRE-SAVING SYSTEMS
 MEASUREMENT SENSORS
 STATIC ELECTRICITY PREVENTION DEVICES
 LASER MARKERS
 PLC
 HUMAN MACHINE INTERFACES
 ENERGY CONSUMPTION VISUALIZATION COMPONENTS
 FA COMPONENTS
 MACHINE VISION SYSTEMS
 UV CURING SYSTEMS
 Selection Guide
 Static Removers
 Cleaning Box
 Pulse Air-gun
 Electrostatic Sensor
ER-X
ER-TF
ER-VS02
ER-VW
ER-Q
ER-F

CHARGE REMOVAL CHARACTERISTICS (TYPICAL)

Measured using a 150 mm × 150 mm 5.906 in × 5.906 in CPM (charge plate monitor) (At center of CPM)

ER-F12 ER-F12S

Solid lines in the graphs show **ER-F12**. Dotted lines show **ER-F12S**.

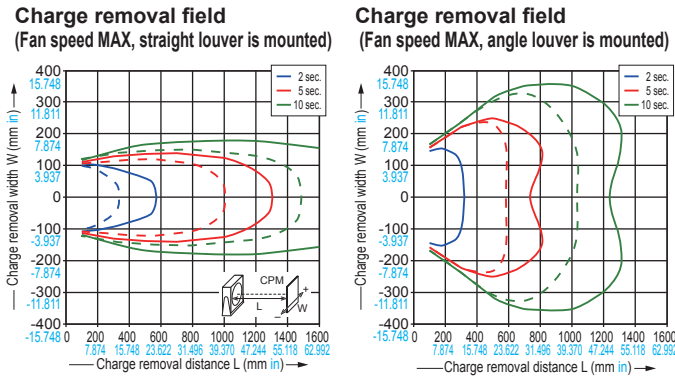

PRECAUTIONS FOR PROPER USE

Refer to p.1501 for general precautions.



- Never use this product in a device for personnel protection.
- In case of using sensing devices for personnel protection, use products which meet laws and standards, such as OSHA, ANSI or IEC etc., for personnel protection applicable in each region or country.
- Do not use this product in places where there may be a danger of flammable or combustible items being present.
- If this product is used in an airtight room, ozone emitted from this product may be detrimental. Therefore, in order for this product to be used in an airtight room, be sure to keep the room ventilated.
- Since the tip of the discharge needle is sharp, take sufficient care in handling the discharge needle.
- Clean the discharge needle regularly, otherwise optimum charge removal performance may not be obtained and fire or operating problems may occur.
- Be sure to ground the frame ground (F.G.) terminal.

DIMENSIONS (Unit: mm in)

The CAD data in the dimensions can be downloaded from our website.

ER-F12 ER-F12S

Ionizer main unit

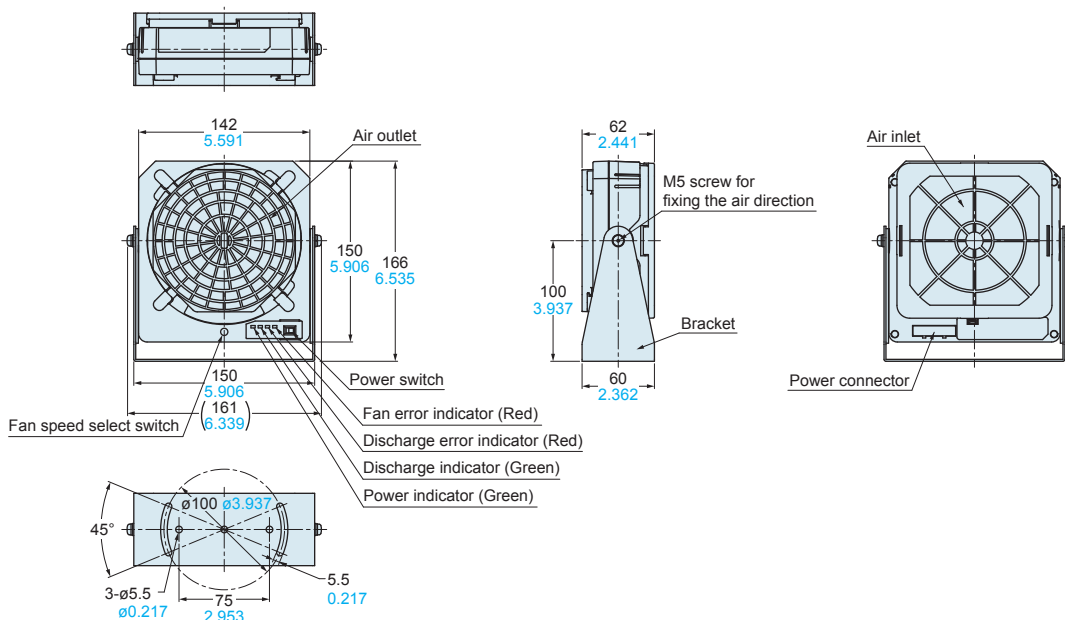

FIBER SENSORS

LASER SENSORS

PHOTO-ELECTRIC SENSORS

MICRO PHOTO-ELECTRIC SENSORS

AREA SENSORS

LIGHT CURTAINS / SAFETY COMPONENTS

PRESSURE / FLOW SENSORS

INDUCTIVE PROXIMITY SENSORS

PARTICULAR USE SENSORS

SENSOR OPTIONS

SMILE WIRE-SAVING UNITS

WIRE-SAVING SYSTEMS

MEASURE-MENT SENSORS

LASER MARKERS

PLC

HUMAN MACHINE INTERFACES

ENERGY CONSUMPTION VISUALIZATION COMPONENTS

FA COMPONENTS

MACHINE VISION SYSTEMS

UV CURING SYSTEMS

UV CURING SYSTEMS

UV CURING SYSTEMS

UV CURING SYSTEMS

UV CURING SYSTEMS

UV CURING SYSTEMS

UV CURING SYSTEMS

UV CURING SYSTEMS

UV CURING SYSTEMS

UV CURING SYSTEMS

UV CURING SYSTEMS

UV CURING SYSTEMS

UV CURING SYSTEMS

UV CURING SYSTEMS

UV CURING SYSTEMS

UV CURING SYSTEMS

UV CURING SYSTEMS

UV CURING SYSTEMS

UV CURING SYSTEMS

UV CURING SYSTEMS

UV CURING SYSTEMS

UV CURING SYSTEMS

UV CURING SYSTEMS

UV CURING SYSTEMS

UV CURING SYSTEMS