



Chipsmall Limited consists of a professional team with an average of over 10 year of expertise in the distribution of electronic components. Based in Hongkong, we have already established firm and mutual-benefit business relationships with customers from,Europe,America and south Asia,supplying obsolete and hard-to-find components to meet their specific needs.

With the principle of "Quality Parts,Customers Priority,Honest Operation,and Considerate Service",our business mainly focus on the distribution of electronic components. Line cards we deal with include Microchip,ALPS,ROHM,Xilinx,Pulse,ON,Everlight and Freescale. Main products comprise IC,Modules,Potentiometer,IC Socket,Relay,Connector.Our parts cover such applications as commercial,industrial, and automotives areas.

We are looking forward to setting up business relationship with you and hope to provide you with the best service and solution. Let us make a better world for our industry!



Contact us

Tel: +86-755-8981 8866 Fax: +86-755-8427 6832

Email & Skype: info@chipsmall.com Web: www.chipsmall.com

Address: A1208, Overseas Decoration Building, #122 Zhenhua RD., Futian, Shenzhen, China



ER-VW

Related Information

- General terms and conditions..... F-7
- Selection guide P.1157~
- Glossary of terms..... P.1497
- General precautions P.1501



panasonic.net/id/pidsx/global

Selectable charge removal layout

Nozzle angle adjustment and joint layout can be selected as desired

Nozzle angle adjustment mechanism

The angles of the two nozzles can be adjusted within a range of approximately 190° by screwing down the ends of the nozzles. After adjusting the angle, turn the ends of the nozzles to tighten them and secure them at that angle. This allows the nozzle angles of the **ER-VW** to be adjusted easily after installation.

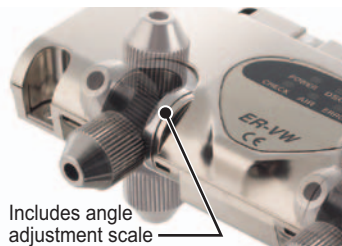

Installation examples

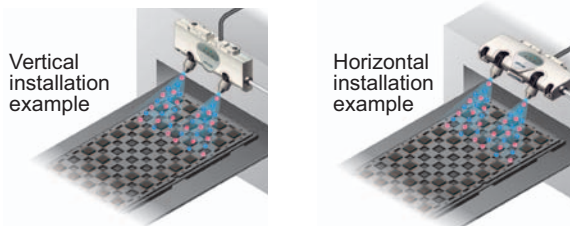

Easy connection layout possible

The joint kit (optional) can be used to connect up to a maximum of 5 **ER-VW** units. The air supply part is connected via quick connection joints, and the power supply and input / output signals can also be connected easily using connection cables with connectors at both ends. Multiple **ER-VW** units can be connected together to provide charge removal layouts that suit the target equipment.

Joint kit (1 kit required for each pair of devices)

- ① Cable with connector on both ends Used to connect power supply, input / output and ground.
- ② Air joint (for replacing plug with hexagonal hole) Used to supply air.

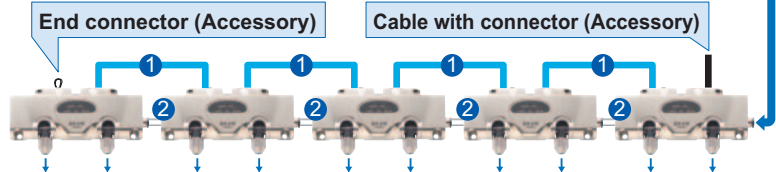

Connection application example

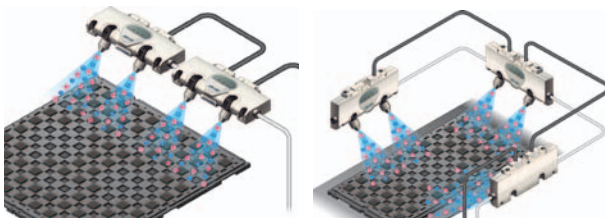

- FIBER SENSORS
- LASER SENSORS
- PHOTOELECTRIC SENSORS
- MICRO PHOTOELECTRIC SENSORS
- AREA SENSORS
- LIGHT CURTAINS / SAFETY COMPONENTS
- PRESSURE / FLOW SENSORS
- INDUCTIVE PROXIMITY SENSORS
- PARTICULAR USE SENSORS
- SENSOR OPTIONS
- SIMPLE WIRE-SAVING UNITS
- WIRE-SAVING SYSTEMS
- MEASUREMENT SENSORS
- STATIC ELECTRICITY PREVENTION DEVICES
- LASER MARKERS
- PLC
- HUMAN MACHINE INTERFACES
- ENERGY CONSUMPTION VISUALIZATION COMPONENTS
- FA COMPONENTS
- MACHINE VISION SYSTEMS
- UV CURING SYSTEMS
- Selection Guide
- Static Removers
- Cleaning Box
- Pulse Air-gun
- Electrostatic Sensor
- ER-X
- ER-TF
- ER-VS02
- ER-VW**
- ER-Q
- ER-F

APPLICATIONS

Removing charges from IC trays

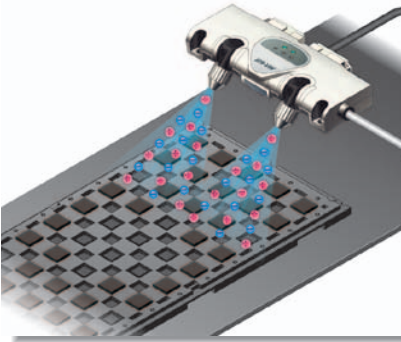

Removing charges during pickup from dicing tape

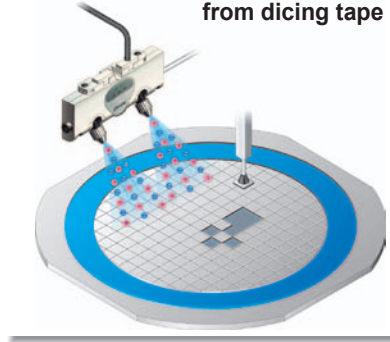

Removing charges from adjacent lead frame conveyor lines

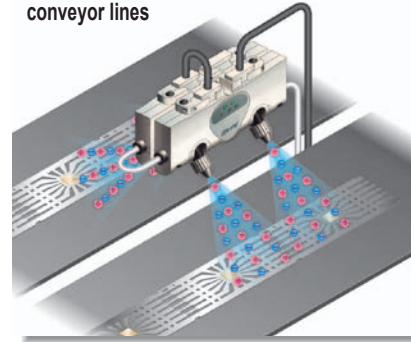

Removing charges surfaces of CDs / DVDs

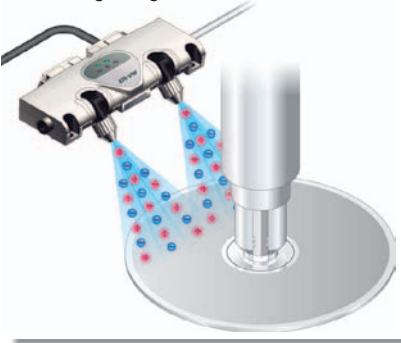

Removing charges from LCD module clamps

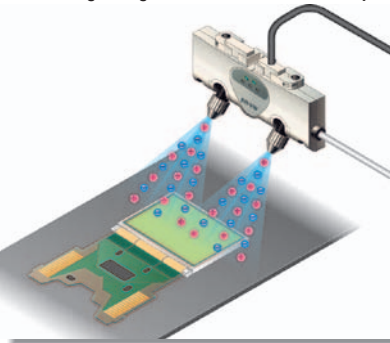

Removing charges during cell production

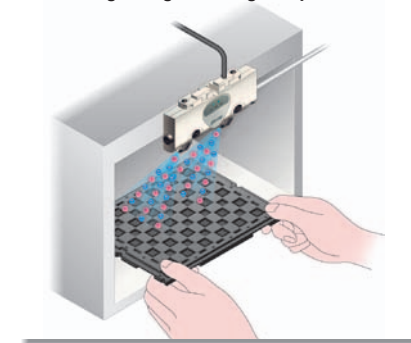

BASIC PERFORMANCE

Minimum air consumption 15 l/min. (ANR)

ER-VW can utilize air flow levels starting from a minimum of 15 l/min. Because the amount of air consumed is so low, the loads placed on air supply equipment can be reduced and costly clean air can be used much more economically.

Comparison of air consumption

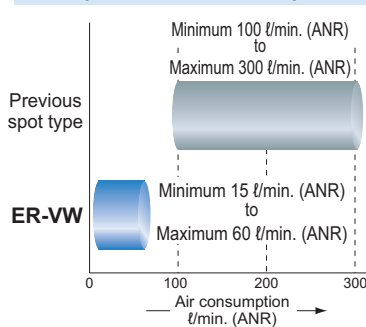

Produces excellent ion balance

The adoption of high-frequency AC method allows extremely stable ion balance to be achieved. The ion balance is not affected by the pressure of air supplied and the setup distance, so no troublesome adjustments are required after setup.

High-frequency 68,000 Hz AC method provides the highest level of charge removal performance

In contrast to previous low-frequency types and DC types, the high-frequency AC type generates (+) ions and (-) ions more efficiently and thus it creates a stable environment with high ion density. This means that a stable ion balance and excellent charge removal performance can be provided regardless of the setting distance.

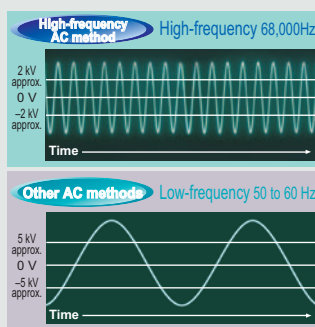

No damage to electronic devices from inverse charging

A high-frequency 68,000 Hz AC corona discharge is used, so that (+) ions and (-) ions are emitted in rapid alternation. Because there are none of the sudden ion discharges that occur with other types, there is no tendency to partial oppositely-charging even when charge removal insulators with different localized charges, so that any damage to electronic devices can be avoided.

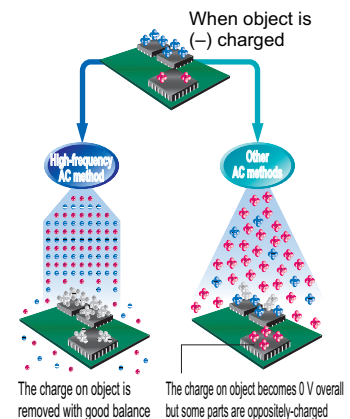

MOUNTING / SIZE

Compact and thin design

The thickness of the unit is 18.9 mm 0.744 in. Even so, the nozzle angles can be adjusted, so that they can still be installed in places where there are space restrictions, such as inside other equipment or along several adjacent production lines.

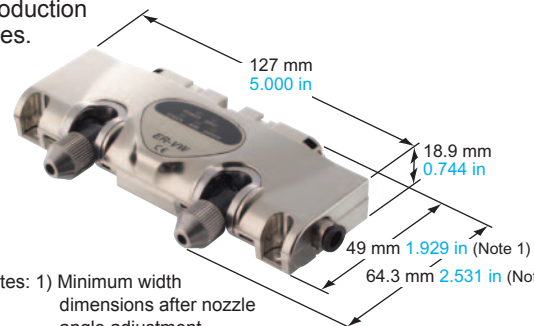

Notes: 1) Minimum width dimensions after nozzle angle adjustment
2) Maximum width dimensions after nozzle angle adjustment

FIBER SENSORS

LASER SENSORS

PHOTOELECTRIC SENSORS

MICRO PHOTOELECTRIC SENSORS

AREA SENSORS

LIGHT CURTAINS / SAFETY COMPONENTS

PRESSURE / FLOW SENSORS

INDUCTIVE PROXIMITY SENSORS

PARTICULAR USE SENSORS

SENSOR OPTIONS

SIMPLE WIRE-SAVING UNITS

WIRE-SAVING SYSTEMS

MEASUREMENT SENSORS

STATIC ELECTRICITY PREVENTION DEVICES

LASER MARKERS

PLC

HUMAN MACHINE INTERFACES

ENERGY CONSUMPTION VISUALIZATION COMPONENTS

FA COMPONENTS

MACHINE VISION SYSTEMS

UV CURING SYSTEMS

Selection Guide

Static Removers

Cleaning Box

Pulse Air-gun

Electrostatic Sensor

ER-X

ER-TF

ER-VS02

ER-VW

ER-Q

ER-F

- FIBER SENSORS
- LASER SENSORS
- PHOTO-ELECTRIC SENSORS
- MICRO PHOTO-ELECTRIC SENSORS
- AREA SENSORS
- LIGHT CURTAINS/SAFETY COMPONENTS
- PRESSURE / FLOW SENSORS
- INDUCTIVE PROXIMITY SENSORS
- PARTICULAR USE SENSORS
- SENSOR OPTIONS
- SIMPLE WIRE-SAVING UNITS
- WIRE-SAVING SYSTEMS
- MEASURE-MENT SENSORS
- STATIC ELECTRICITY PREVENTION DEVICES
- LASER MARKERS
- PLC
- HUMAN MACHINE INTERFACES
- ENERGY CONSUMPTION VISUALIZATION COMPONENTS
- FA COMPONENTS
- MACHINE VISION SYSTEMS
- UV CURING SYSTEMS

FUNCTIONS

Air supply monitoring function New concept

This function causes discharging to stop automatically if the supply of air drops below a certain pressure. Notification of this is given when the AIR indicator lights and the discharge output (DSC) turns off. This prevents objects which are not charged from being overlooked when the air supply has been stopped.

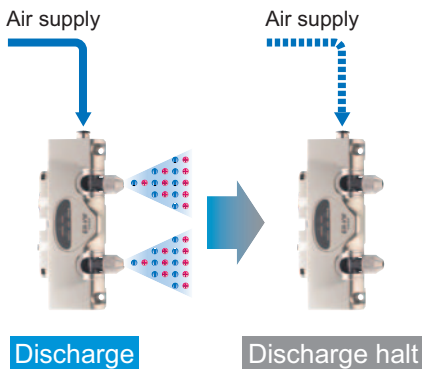

The functions support accurate charge removal

In addition to the air supply monitoring function, the **ER-VW** is equipped with the following functions to ensure accurate charge removal.

<p>Power supply</p> <p>POWER</p> <p>Discharge needle condition</p> <p>CHECK</p> <p>Air supply monitoring</p> <p>AIR</p>		<p>Discharge</p> <p>DSC</p> <p>Abnormal discharge</p> <p>ERROR</p>
---	--	---

- Discharge halt function: Uses external input to forcibly stop discharge.
- Check function : Uses the CHECK indicator and output to notify the operator when it is time to clean or replace the discharge needle.
- Abnormal discharge: Uses the ERROR indicator and output to notify the operator when a problem with discharge occurs, and stops discharge. It can be canceled by means of reset input.
- Discharge output: Output is ON during discharging. This lets you check when discharging is being carried out.
- Check output : Output turns ON when the discharge needle is dirty.
- Error output : Output turns OFF when there is a problem with discharging (normally it is ON). It also allows you to check the power supply to the ionizer.

ORDER GUIDE

Ionizer main unit One each of connector attached cable (length 0.5 m 1.640 ft), end connector and lead wire for connecting F.G. are supplied with the ionizer main unit.

Type	Appearance	Charge removal time (±1,000 V → ±100 V)	Ion balance	Model No.
Spot type		1 sec. or less (Note 1)	±10 V or less (Note 1)	ER-VW (Note 2)

Notes: 1) A typical sample applied with a supply voltage of 24 V, a distance of 100 mm 3.937 in from the front surface of the air flow outlet and a pressure of 0.25 MPa. (Measured on a sample left in the atmosphere at a relative humidity of 65 % RH or less for 24 hours or more.)
 2) The PNP output type is also available.

OPTIONS

Type	Model No.	Description	
Connector attached cable (Note)	ER-VWCC2	Length: 2 m 6.562 ft, Net weight: 52 g approx.	0.15 mm ² 8-core cabtyre cable with connector Cable outer diameter: ø4.2 mm ø0.165 in
	ER-VWCC5	Length: 5 m 16.404 ft, Net weight: 120 g approx.	
	ER-VWCC9	Length: 9 m 29.528 ft, Net weight: 240 g approx.	
Mini line filter	ER-AF10	Processed air volume 40 l/min. (ANR)	Removes solid particles such as dirt and dust from air supply • Collected particle dia.: 0.1 µm 0.004 mil • Collection efficiency: 99.9 %
	ER-AF20	Processed air volume 80 l/min. (ANR)	
Discharge needle unit	ER-VWANT	Unit with replacement tungsten needles (2 needles per set)	
Joint kit	ER-VWAR80	Connection cable (cable length 0.8 m 2.625 ft) and air tube joint: 1 pc. each	

Connector attached cable

- **ER-VWCC**□

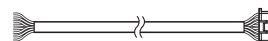

Mini line filter

- **ER-AF10**
- **ER-AF20**



* The photograph shows **ER-AF10**

Discharge needle unit

- **ER-VWANT**



Note: One connector attached cable (length 0.5 m 1.640 ft) is supplied with the ionizer main unit. Please order it, if you need.

- Selection Guide
- Static Removers
- Cleaning Box
- Pulse Air-gun
- Electrostatic Sensor
- ER-X**
- ER-TF**
- ER-VS02**
- ER-VW**
- ER-Q**
- ER-F**

SPECIFICATIONS

Item	Type	Spot type
	Model No.	ER-VW
Charge removal time ($\pm 1,000$ V \rightarrow ± 100 V)		1 sec. or less (Note 2)
Ion balance		± 10 V or less (Note 2)
Ozone generation		0.05 ppm or less (Note 3)
Applicable fluid		Air (dried clean air) (Note 4)
Supplied air flow		60 l/min. (ANR) or less
Air pressure range		0.05 to 0.5 MPa
Supply voltage		24 V DC \pm 10 %
Current consumption		120 mA or less
Discharge method		High frequency AC method
Discharge output voltage		2,000 V approx.
Output [Check (CHECK) Error (ERROR) Discharge (DSC) (Note 5)]		NPN open-collector transistor <ul style="list-style-type: none"> • Maximum sink current: 50 mA • Applied voltage: 30 V DC or less (between output and 0 V) • Residual voltage: 1 V or less (at 50 mA sink current)
Output operation		Check output (CHECK): ON when the discharge needle is dirty or worn, OFF when operation is normal Error output (ERROR): OFF when abnormal discharge is detected, ON when operation is normal Discharge output (DSC) (Note 5): ON when discharging, OFF when discharge halts
Short-circuit protection		Incorporated
Discharge halt input (DSC OFF) (Note 5)		Short-circuit to 0 V: Discharge halt, Open: Discharge allowed (operation start)
Reset input (RESET)		In the state that operation is stopped due to an error detection, open 0 V of the power supply from short-circuit state to cancel ERROR
Indicators	Power (POWER)	Green LED (lights up when the power is ON)
	Discharge (DSC) (Note 5)	Green LED (lights up when discharging)
	Air monitoring (AIR) (Note 6)	Orange LED (lights up when no air is being supplied)
	Check (CHECK)	Orange LED (lights up when the discharge needle is dirty or worn, etc.)
	Error (ERROR)	Red LED (lights up when abnormal discharge is detected)
Ambient temperature		0 to +55 °C +32 to +131 °F (No dew condensation), Storage: -10 to +65 °C +14 to +149 °F
Ambient humidity		35 to 65 % RH (No dew condensation), Storage: 35 to 65 % RH
I/O connector		For power & input / output: 8-pin connector, For connection: 9-pin connector
Connectable units		Maximum number of connectable units: 5 (Including this unit)
Enclosure earthing		Capacitor earth
Material		Enclosure: ABS (Nickel plated), Nozzle mount, Screw mount, Nozzle: Stainless steel (SUS), Discharge needle: Tungsten
Weight		Net weight: 110 g approx., Gross weight: 180 g approx.
Accessories		Connector attached cable: 1 pc. (length 0.5 m 1.640 ft), End connector (9-pin): 1 pc., Lead wire for connecting F.G.: 1 pc.

- Notes: 1) Where measurement conditions have not been specified precisely, the conditions used were an ambient temperature of +20 °C **+68 °F**.
2) A typical sample applied with a supply voltage of 24 V, a distance of 100 mm **3.937 in** from the front surface of the air flow outlet and a pressure of 0.25 MPa. (Measured on a sample left in the atmosphere at a relative humidity of 65 % RH or less for 24 hours or more.)
3) A typical sample applied with a supply voltage of 24 V, a distance of 300 mm **11.811 in** from the front surface of the air flow outlet and a pressure of 0.25 MPa.
4) Dried clean air is the air passing through air dryer (dew point -20 °C **-4 °F** approx.) and air filter (mesh size 0.01 μ m **0.0004 mil** approx.)
5) "DSC" is an abbreviated name of "DISCHARGE".
6) Discharge halts when lights up.

FIBER
SENSORSLASER
SENSORSPHOTO-
ELECTRIC
SENSORSMICRO
PHOTO-
ELECTRIC
SENSORSAREA
SENSORSLIGHT
CURTAINS /
SAFETY
COMPONENTSPRESSURE /
FLOW
SENSORSINDUCTIVE
PROXIMITY
SENSORSPARTICULAR
USE
SENSORSSENSOR
OPTIONSSIMPLE
WIRE-SAVING
UNITSWIRE-SAVING
SYSTEMSMEASURE-
MENT
SENSORSSTATIC
ELECTRICITY
PREVENTION
DEVICESLASER
MARKERS

PLC

HUMAN
MACHINE
INTERFACESENERGY
CONSUMPTION
VISUALIZATION
COMPONENTSFA
COMPONENTSMACHINE
VISION
SYSTEMSUV
CURING
SYSTEMSSelection
GuideStatic
RemoversCleaning
BoxPulse
Air-gunElectrostatic
Sensor**ER-X****ER-TF****ER-VS02****ER-VW****ER-Q****ER-F**

- FIBER SENSORS
- LASER SENSORS
- PHOTO-ELECTRIC SENSORS
- MICRO PHOTO-ELECTRIC SENSORS
- AREA SENSORS
- LIGHT CURTAINS / SAFETY COMPONENTS
- PRESSURE / FLOW SENSORS
- INDUCTIVE PROXIMITY SENSORS
- PARTICULAR USE SENSORS
- SENSOR OPTIONS
- SIMPLE WIRE-SAVING UNITS
- WIRE-SAVING SYSTEMS
- MEASUREMENT SENSORS
- STATIC ELECTRICITY PREVENTION DEVICES
- LASER MARKERS
- PLC
- HUMAN MACHINE INTERFACES
- ENERGY CONSUMPTION VISUALIZATION COMPONENTS
- FA COMPONENTS
- MACHINE VISION SYSTEMS
- UV CURING SYSTEMS

I/O CIRCUIT AND WIRING DIAGRAMS

I/O circuit diagram

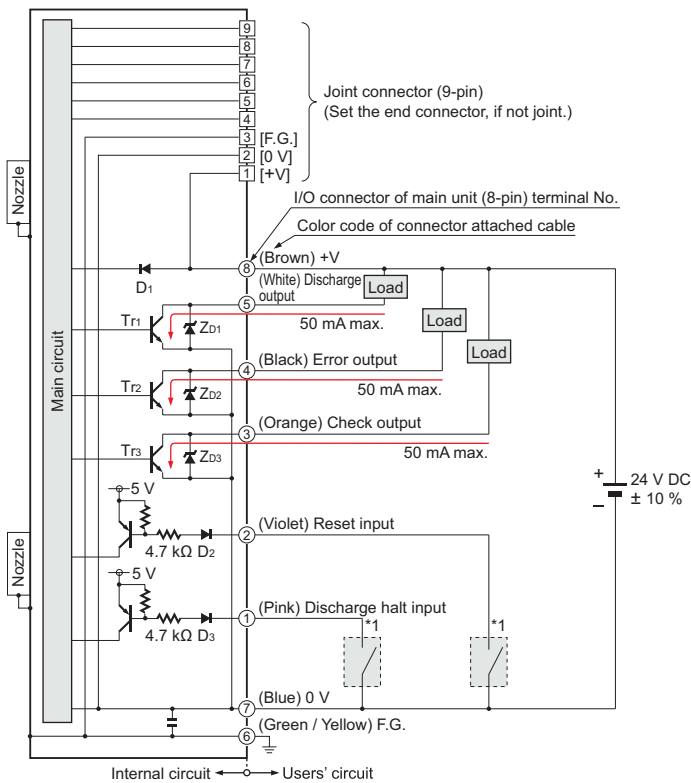

Symbols ... D1: Reverse supply polarity protection diode
D2, D3: Input protection diode
ZD1, ZD2, ZD3 : Surge absorption zener diode
Tr1, Tr2, Tr3 : NPN output transistor

* 1

Non-voltage contact or NPN open-collector transistor

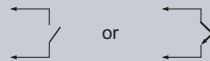

- Discharge halt input
Low (0 V): Discharge halt
High (Open): Discharge (Operation starts)
- Reset input
In the state that operation is stopped due to an error detection, open 0 V of the power supply from short-circuit state to cancel ERROR.

Connector terminal arrangement

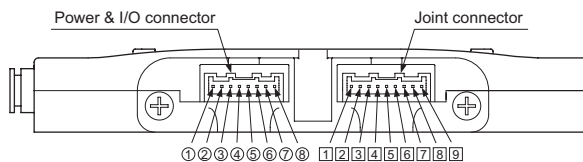

Input signal condition

• Discharge halt input

• Reset input

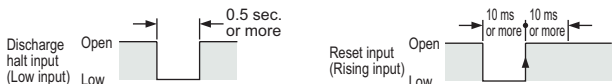

Note: Repeated control using "Discharge halt input" input should be carried out at 1 Hz or less.
Continuous discharging for 2 sec. or more is required for stable sensing of check output.
If using with repeated control operations that include discharges of 2 sec. or less, use continuous discharges of 2 sec. or more to check the check output when carrying out maintenance.

CHARGE REMOVAL CHARACTERISTICS (TYPICAL)

Measured using a 150 mm × 150 mm 5.906 in × 5.906 in CPM (charge plate monitor). (At center of CPM)

Air flow

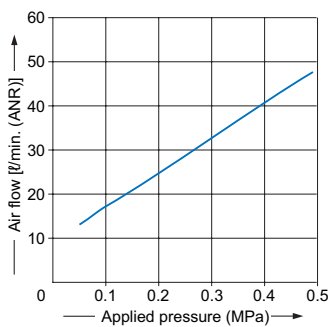

Correlation between charge removal distance and ion balance

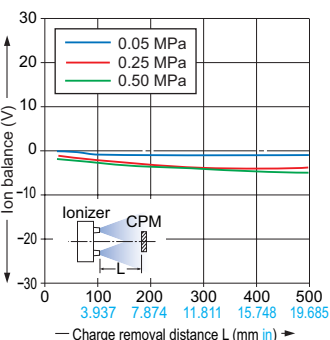

Correlation between charge removal distance and charge removal time

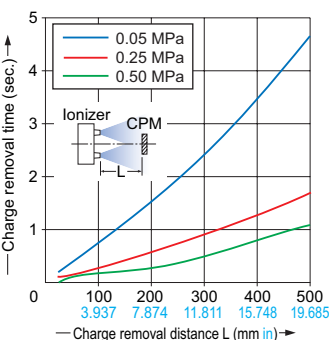

Charge removal field (0.50 MPa)

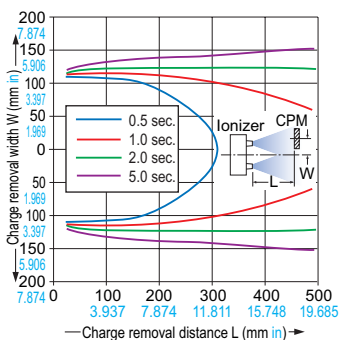

- Selection Guide
- Static Removers
- Cleaning Box
- Pulse Air-gun
- Electrostatic Sensor
- ER-X
- ER-TF
- ER-VS02
- ER-VW
- ER-Q
- ER-F

PRECAUTIONS FOR PROPER USE

Refer to p.1501 for general precautions.

- This product is to remove static electricity for industrial use. Never use this product for medical equipment etc. relating to maintenance / supervision of human life or body, for prevention of accidents which damage a human life or properties, or for safety maintenance.
- Do not use this product near or around surroundings containing any dangerous materials, such as combustible material and flammable material.
- The discharge needle gathers dust after a long period of use. In order to prevent accident or product malfunction, clean up the discharge needle, periodically once every two weeks or so, or this product will be unable to exert the charge removal performance.
- Be sure to ground the main body of this product via ground terminal to ensure electric shock prevention and reliable charge removal.
- Since the discharge needle is live with high voltage, never touch the discharge needle, or an electric shock may result.
- If this product is used in an airtight room, ozone emitted from this product may be detrimental. Therefore, in order for this product to be used in an airtight room, be sure to keep the room ventilated.
- Since the ion air contains ozone, do not aim this product at anyone.
- Always be sure to turn off the air supply before loosening the nozzles to carry out air flow adjustment or for maintenance. Air pressure may cause the discharge needle to fly out. Furthermore, push the nozzle securely in by hand until it touches into the enclosure of the device afterwards, and check that the nozzle does not move. If the nozzle is not installed correctly, it will adversely affect charge removal performance and the nozzle may also fall out.
- Since the tip of the discharge needle is pointed, take sufficient care in handling the discharge needle, or injuries may result.

**Mounting**

- When installing the unit to its mount, use M4 pan head screws (please arrange separately), and tighten them at a torque of 0.5 N·m or less.
- Be sure to connect the F.G. terminal to ground. If the unit is not properly grounded, charge removal performance will be severely reduced. (Use a type D ground or a common power supply ground.)
- If grounding to a common power supply ground, you can use the lead wire for connecting the F.G. that is supplied with the unit to make the connection.
0 V ground: Connect pins 2 and 3 of the end connector (9-pin) to the lead wire for connecting the F.G..
+V ground: Connect pins 1 and 3 of the end connector (9-pin) to the lead wire for connecting the F.G..

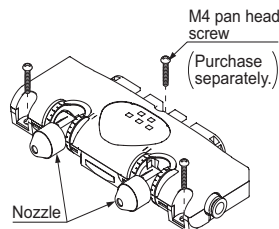

(If the ground is not connected correctly, operating problems or accidents may occur, so be sure to check the usage conditions and connect the ground in such a way that the power supply does not become shorted.)

Adjusting the air blowing direction

- After screw down the nozzle to loosen it, point it toward the object to be charge removal. After adjusting the position, securely tighten the nozzle by hand until it is touching the enclosure, and check that the nozzle does not move. If the nozzle is not installed correctly, it will adversely affect charge removal performance and the nozzle may also fall out.
- The diagram at right shows the range of adjustment for the nozzles.

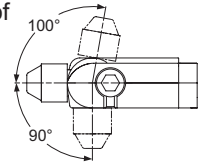
**Piping**

- The tube that is installed to the air intake of this device should have an outside diameter of 6 mm **0.236 in** and an inside diameter of 4 mm **0.157 in**.
- The air that is supplied to this product should be dried clean air that has been processed through an air dryer (dew point around $-20\text{ }^{\circ}\text{C}$ $-4\text{ }^{\circ}\text{F}$) and an air filter (mesh size around $0.01\mu\text{m}$ **0.0004 mil**).
- Increasing the length of the air hose from the air supply equipment or adding pneumatic equipment (such as a needle valve, governor or miniature filter) will cause drops in the pressure of the air supplied to the device, and so do not allow the air pressure to drop below sufficient levels. (Check the pressure applied to the device at the air intake of the device.)
Furthermore, select air pressure equipment that is appropriate for the level of supplied air flow.

Connections

- Use the **ER-VWAR80** joint kit (optional) to connect the devices together. (1 kit is needed for each pair of devices.) Up to a maximum of 5 units can be connected together (including this unit).
When using units that are connected together in this way, attach the supplied end connector to the connector of the last device in the series. Furthermore, also connect the end connector to a device if not connecting the device to any other devices.
- The air joint (included in the joint kit) should be tightened at a torque of 0.5 N·m or less.
- When connecting devices together, check that the air pressure values at the air intakes of each device are appropriate for the usage conditions.

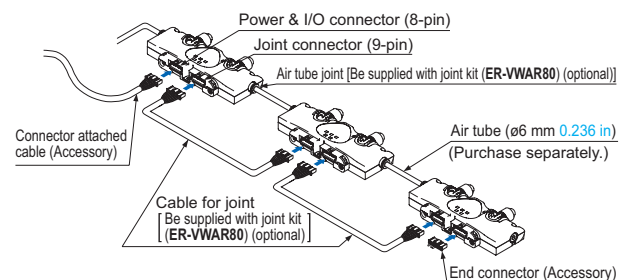

FIBER SENSORS

LASER SENSORS

PHOTO-ELECTRIC SENSORS

MICRO PHOTO-ELECTRIC SENSORS

AREA SENSORS

LIGHT CURTAINS / SAFETY COMPONENTS

PRESSURE / FLOW SENSORS

INDUCTIVE PROXIMITY SENSORS

PARTICULAR USE SENSORS

SENSOR OPTIONS

SIMPLE WIRE-SAVING UNITS

WIRE-SAVING SYSTEMS

MEASUREMENT SENSORS

STATIC ELECTRICITY PREVENTION DEVICES

LASER MARKERS

PLC

HUMAN MACHINE INTERFACES

ENERGY CONSUMPTION VISUALIZATION COMPONENTS

FA COMPONENTS

MACHINE VISION SYSTEMS

UV CURING SYSTEMS

Selection Guide

Static Removers

Cleaning Box

Pulse Air-gun

Electrostatic Sensor

ER-X**ER-TF****ER-VS02****ER-VW****ER-Q****ER-F**

PRECAUTIONS FOR PROPER USE

Refer to p.1501 for general precautions.

Maintenance



- Always be sure that the power supply and the air supply are both turned off before inspection and cleaning.
- Be sure to turn off the air before removing the nozzles for purposes such as maintenance. Air pressure may cause the discharge needles to fly out.

- Since the removal discharge effect will deteriorate if dirt is stuck to the tip of the discharge needle, clean the discharge needle periodically.
- The maintenance required depends on the environment of use. As a reference, the maintenance should be done once in two weeks.
- The discharge needle is a part having a product life time. It is recommended that the needle should be replaced, as a reference, after 10,000 hours in use. When replacing it, replace the whole unit (**ER-VWANT**).

Cleaning procedure and discharge needle replacement procedure

- ① Check that the power is turned off.
- ② Check that no air is being supplied.
- ③ Turn the nozzle counterclockwise to remove it.
- ④ Replace the discharge needle unit, or use a cotton swab moistened in alcohol to clean the discharge needle and the area around it.
For the needle discharge unit while running it along the guide at the side of the opening.
- ⑤ After cleaning, turn the nozzle clockwise to install it. Securely tighten the nozzle by hand until it is touching the enclosure, and check that the nozzle does not move. If the nozzle is not installed correctly, it will adversely affect charge removal performance and the nozzle may also fall out.

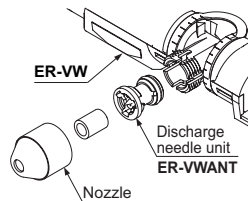

Others

- Make sure to use the DC power supply insulated by an isolation transformer, etc. for this product. If an auto-transformer, etc. (single winding transformer) is used, this product or the power supply may be damaged due to short-circuit.

- Do not use this product beyond its rated specifications. Doing so can cause product breakdown, non-function, or damage. Furthermore, it will also cause a marked reduction in product life.
- Never disassemble, repair, modify, or misuse this product, as this can cause an accident or malfunction.
- Do not throw this product into fire: it may explode or generate poisonous gas.
- Since this product emits ozone into the atmosphere, circulate air to prevent foul smells. If ozone lingers for long periods, metals, etc. may oxidize / decay. Furthermore, do not try to confirm that foul smells are caused by the ozone by drawing your face near the nozzle outlet and air outlet: you may hurt your nose, throat, etc.
- Do not use this product in steamy or dusty places, in places where water and oil splash, or where spatter flies when welding.

- Make sure that the power supply is off while wiring and inspection. Otherwise, there is a danger of accident, electric shock or malfunction.
- Do not use during the initial transient time (0.5 sec.) after the power supply is switched on.
- Verify that the supply voltage variation is within the rating.
- If the power supply is switched on immediately after being switched off, fault output may be generated. After the power supply is switched off, wait at least 1 sec. before switching it on again.
- If power is supplied from a commercial switching regulator, ensure that the frame ground (F.G.) terminal of the power supply is connected to an actual ground.
- In case a surge is generated in the used power supply, connect a surge absorber to the supply and absorb the surge.
- Do not run the wires together with high-voltage lines or power lines or put them in the same raceway. This can cause malfunction due to induction.
- Confirm the wiring and piping state before supplying power or air. Wrong wiring and piping may cause malfunction.
- Use air (dry, clean air) for the fluid. Any fluid other than air (dry, clean air) or even air containing corrosive gas may cause an accident or malfunction.
- Do not use air that contains foreign particles, e.g. carbon dust, dust, water or oil. Since these substances may cause electric shock or malfunction, take appropriate countermeasures, e.g. install an airfilter, air-drier, etc.
- Do not use this product for any purpose other than charge removal.
- Do not cover the ionized air outlets of the nozzles. Ozone may build up and operating problems or failure may occur. (The air monitoring function checks if the pressure of air supplied to the unit drops, so if the ionized air outlets of the nozzles are covered, it will not detect this and will not cause charge removal operation to stop.)
- This product is CE-conformed under the EMC Directive. The immunity adopted by this product should be conformable to EN 61000-6-2. In order for such immunity to be conformable to this standard, all wires connected to this product should be limited in length to less than 10 m **32.808 ft.**
- When this product is no longer usable or required, dispose of properly as industrial waste.

FIBER SENSORS

LASER SENSORS

PHOTO-ELECTRIC SENSORS

MICRO PHOTO-ELECTRIC SENSORS

AREA SENSORS

LIGHT CURTAINS / SAFETY COMPONENTS

PRESSURE / FLOW SENSORS

INDUCTIVE PROXIMITY SENSORS

PARTICULAR USE SENSORS

SENSOR OPTIONS

SIMPLE WIRE-SAVING UNITS

WIRE-SAVING SYSTEMS

MEASUREMENT SENSORS

STATIC ELECTRICITY PREVENTION DEVICES

LASER MARKERS

PLC

HUMAN MACHINE INTERFACES

ENERGY CONSUMPTION VISUALIZATION COMPONENTS

FA COMPONENTS

MACHINE VISION SYSTEMS

UV CURING SYSTEMS

Selection Guide

Static Removers

Cleaning Box

Pulse Air-gun

Electrostatic Sensor

ER-X

ER-TF

ER-VS02

ER-VW

ER-Q

ER-F

DIMENSIONS (Unit: mm in)

The CAD data in the dimensions can be downloaded from our website.

ER-VW

Ionizer main unit

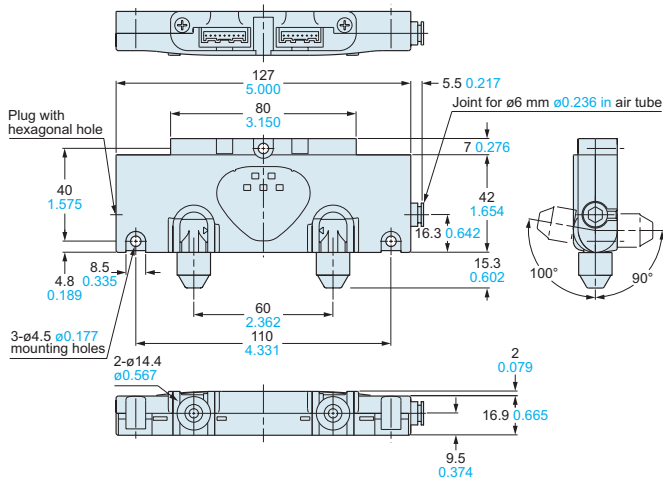
FIBER
SENSORSLASER
SENSORSPHOTO-
ELECTRIC
SENSORSMICRO
PHOTO-
ELECTRIC
SENSORSAREA
SENSORSLIGHT
CURTAINS /
SAFETY
COMPONENTSPRESSURE /
FLOW
SENSORSINDUCTIVE
PROXIMITY
SENSORSPARTICULAR
USE
SENSORSSENSOR
OPTIONSSIMPLE
WIRE-SAVING
UNITSWIRE-SAVING
SYSTEMSMEASURE-
MENT
SENSORSSTATIC
ELECTRICITY
PREVENTION
DEVICESLASER
MARKERS

PLC

HUMAN
MACHINE
INTERFACESENERGY
CONSUMPTION
VISUALIZATION
COMPONENTSFA
COMPONENTSMACHINE
VISION
SYSTEMSUV
CURING
SYSTEMSSelection
GuideStatic
RemoversCleaning
BoxPulse
Air-gunElectrostatic
Sensor**ER-X****ER-TF****ER-VS02****ER-VW****ER-Q****ER-F**