



Chipsmall Limited consists of a professional team with an average of over 10 year of expertise in the distribution of electronic components. Based in Hongkong, we have already established firm and mutual-benefit business relationships with customers from,Europe,America and south Asia,supplying obsolete and hard-to-find components to meet their specific needs.

With the principle of "Quality Parts,Customers Priority,Honest Operation,and Considerate Service",our business mainly focus on the distribution of electronic components. Line cards we deal with include Microchip,ALPS,ROHM,Xilinx,Pulse,ON,Everlight and Freescale. Main products comprise IC,Modules,Potentiometer,IC Socket,Relay,Connector.Our parts cover such applications as commercial,industrial, and automotives areas.

We are looking forward to setting up business relationship with you and hope to provide you with the best service and solution. Let us make a better world for our industry!



Contact us

Tel: +86-755-8981 8866 Fax: +86-755-8427 6832

Email & Skype: info@chipsmall.com Web: www.chipsmall.com

Address: A1208, Overseas Decoration Building, #122 Zhenhua RD., Futian, Shenzhen, China



Panasonic

Pulse AC Method
Area Ionizer

ER-X SERIES

CE
Conforming to
EMC Directive

10V
Certified by NRTL

High-Speed, Airless Charge Removal

Introducing Spot Type, Ultra
Compact Type and High / Low
Temperature Resistant Type Heads

Three charge removal modes for diverse application coverage

The **ER-X** series offers an airless charge removal capability to eliminate the need for compressed air in addition to low pressure and high speed compressed air based modes. Furthermore, it supports dual-head configurations for expanded application coverage.

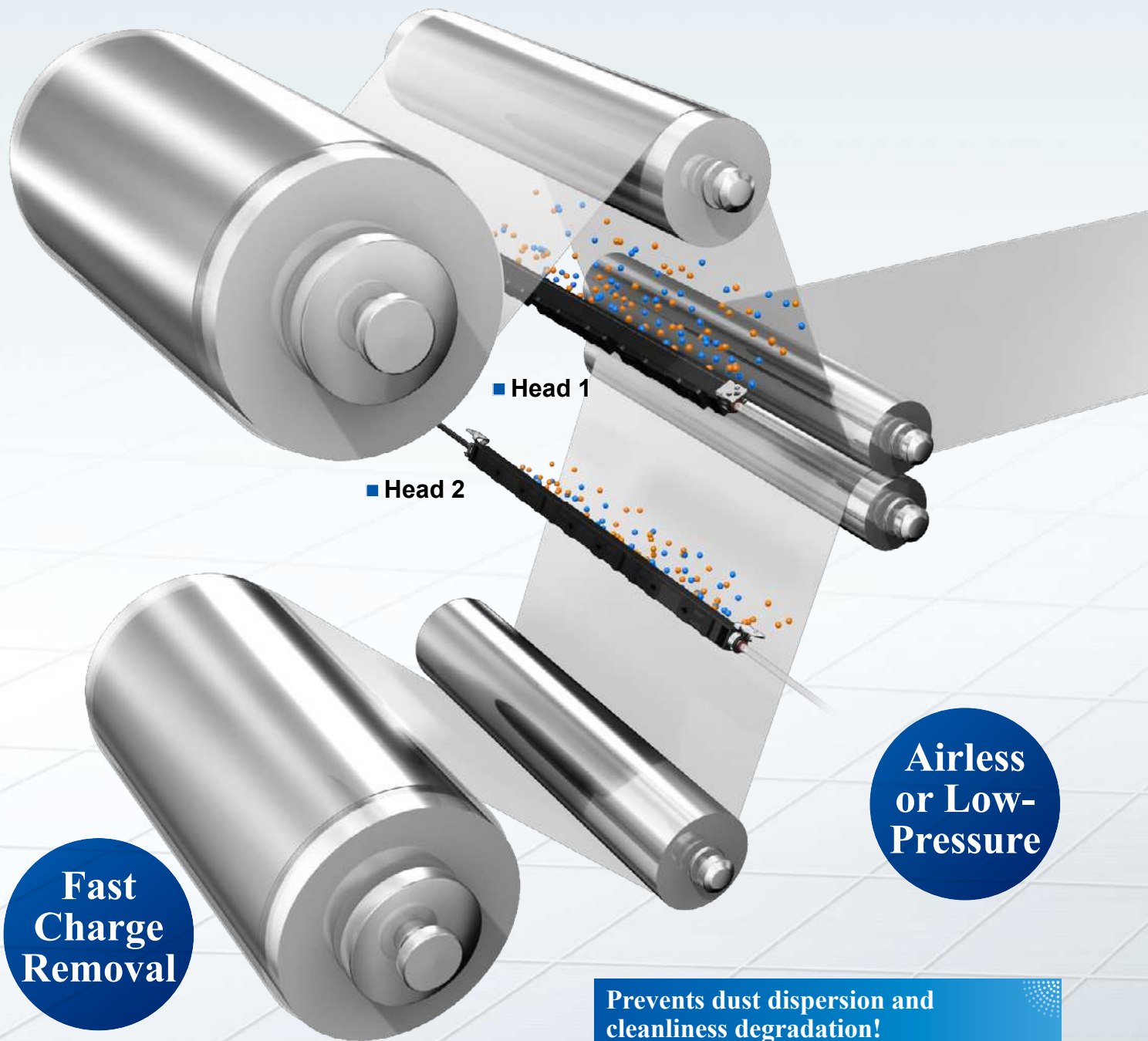

Massive ion discharge when using air reduces charge removal time.

By applying a compressed air source, the ion volume increases providing an improved tact time for substrate ionization. This makes the **ER-X** suitable for applications such as electronic paper and thin film solar cells, where charge removal time is directly linked to productivity.

Prevents dust dispersion and cleanliness degradation!

The **ER-X** series can effectively remove surface charges with an air pressure of less than 0.05 MPa. With the advantage of minimal dust dispersion, it is suitable for charge removal in semiconductor, FPD (mobile panel), and other applications that require high degree of cleanliness. The presence of air also helps prevent adhesion of dust to the discharge needles, requiring less cleaning than in the airless charge removal mode.

Pulse AC method for faster charge removal

The **ER-X** series has adopted the pulse AC method that alternately applies positive and negative voltages to each discharge needle. This enables generation and discharge of a large amount of ions, resulting in faster charge removal. Select from eight pulse frequencies according to your application, from 100 Hz for charge removal on nearby or moving workpieces to 1 Hz for charge removal on far-away workpieces or in a three-dimensional space.

Charge removal time characteristics (TYPICAL)

Measured at a charge removal distance of 100 mm 3.937 in using a 150×150 mm 5.906×5.906 in CPM (at center of CPM).

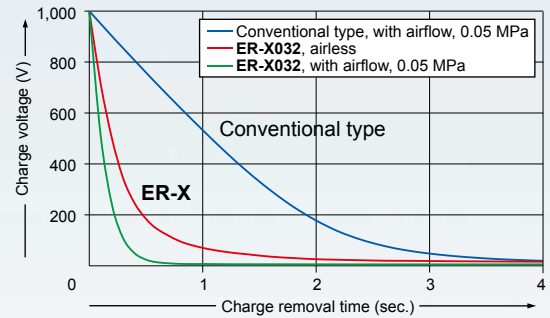

Automatic ion balance control

The **ER-X** series provides an automatic ion balance control mechanism that senses the amount of ions being generated (which changes according to environmental factors) and compensate for this deviation in the controller, thus maintaining a highly stable ion balance as an original operator setting.

Pulse AC method

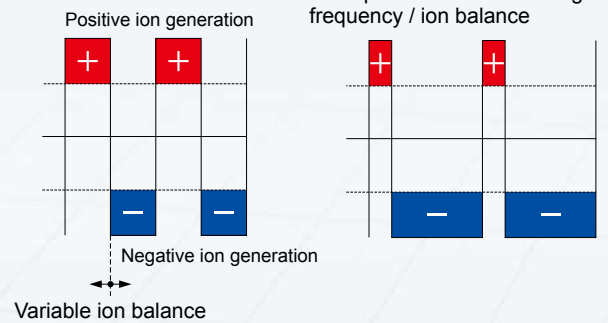

Prevention of part feeder clogging



High-speed charge removal on FPCs

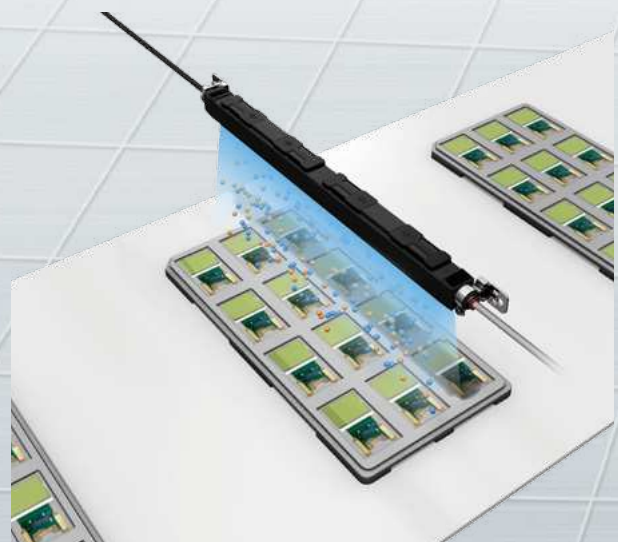

Bar type head

Helping save time with high-speed charge removal made possible by high ion volume

ER-X008

Effective charge removal width:
80 mm 3.150 in approx.

ER-X016

Effective charge removal width:
160 mm 6.299 in approx.

ER-X032

Effective charge removal width:
320 mm 12.598 in approx.

ER-X048

Effective charge removal width:
480 mm 18.898 in approx.

ER-X064

Effective charge removal width:
640 mm 25.197 in approx.

High and low temperature resistant type also available

ER-X□HC NEW

Bar type head compatible with ambient temperatures of -60 to +200 °C
-76 to +392 °F is available.



Applications

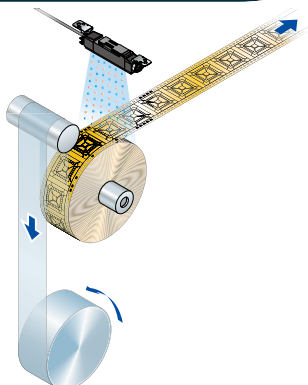

Charge removal and dust removal while separating TAB protective film

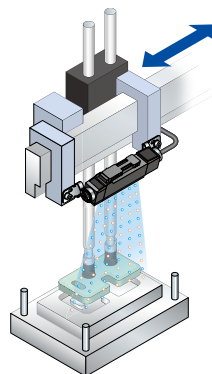

Charge removal of molded plastic components on a conveyor belt

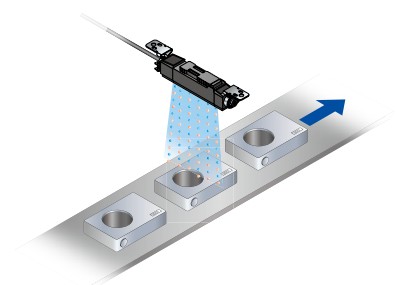

Charge removal and dust removal of digital camera cases on a conveyor belt

Super-compact slim head

By thoroughly redesigning the discharge needle, we have created a super-compact slim head that combines high-speed charge removal*1 with a maintenance-saving design*2. The **ER-X** series can be embedded in, or retrofitted onto, equipment that did not provide enough space for antistatic measures in the past.

- *1 Pulse AC method with built-in air tubes (max. pressure 0.5 MPa)
- *2 Discharge needle air barrier structure, discharge needle unit for simple need replacement

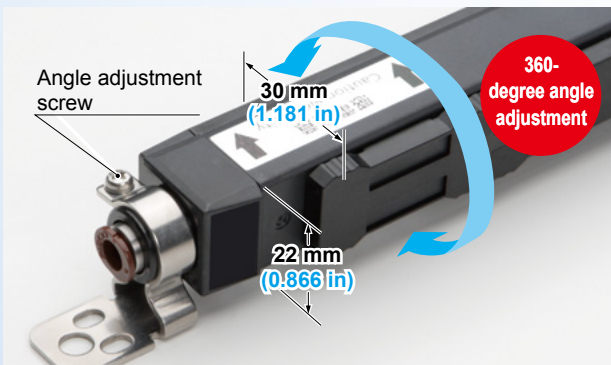

Flat discharge surface for easy cleaning

The **ER-X** series heads have a flat discharge face, allowing effortless cleaning of the discharge needles and air outlets by simply brushing along the groove provided.

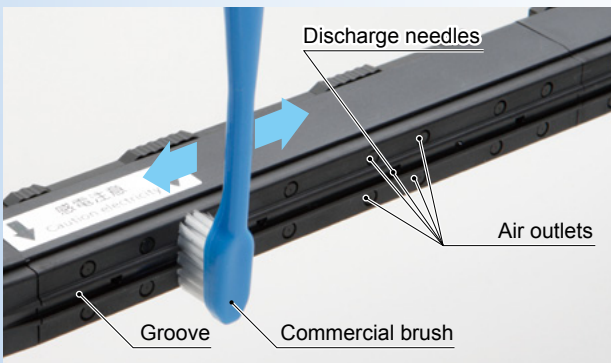

Discharge needle air barrier design for reduced contamination

A barrier of clean air around the discharge needle keeps foreign matter from adhering to it, preventing degraded performance. Additionally, by using separate air sources for the discharge needle barrier and ion transport, the **ER-X** series keeps discharge from becoming unstable due to pressure concentration, allowing the device to efficiently generate and transport ions.

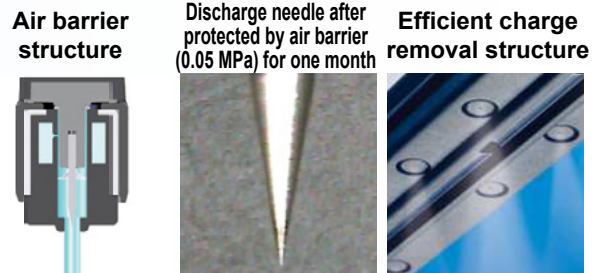

Carefully designed to prevent contamination in manufacturing processes

In consideration of the manufacturing process (secondary cells etc.), the **ER-X** series heads neither use copper nor plate processing. This minimizes the risk of contamination with foreign substances.

Discharge needle unit for simple needle replacement

The removable discharge needle unit (including a set of four needles) substantially simplifies maintenance. To remove the unit, just slide it toward both ends as indicated by the arrows.

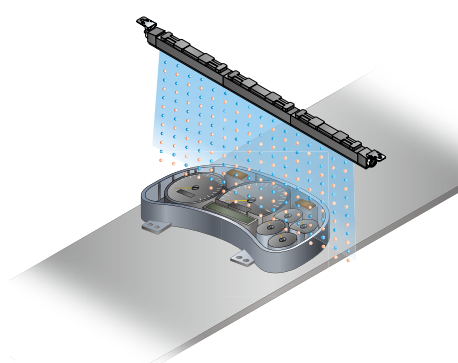
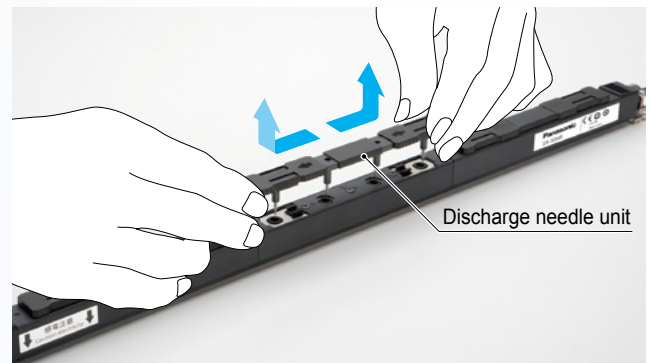

Removing dust during instrument panel assembly

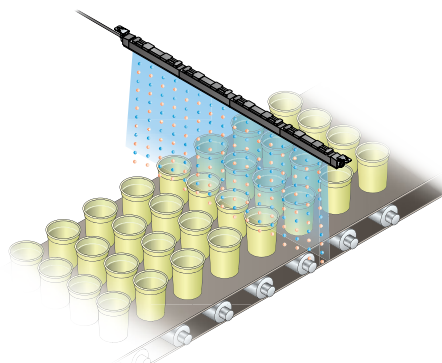

Removing dust during food product cup transport

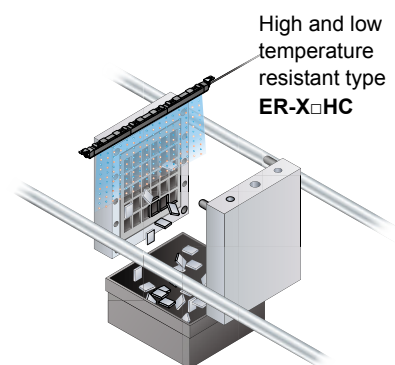

Preventing adhesion of molded parts to molds

Spot type head

Fastest charge removal* in the industry with ER-X area ionizer with spot type head

* Based on research conducted by our company as of March 2016.

ER-X001

Effective charge removal width:
50 mm 1.969 in approx.



0.3 sec. or less*¹ fastest charge removal achieved with pulse AC method spot type ionizer*².

The pulse AC method enables the **ER-X001** to generate and discharge a large amount of ions, which makes charge removal faster. Furthermore, as a spot type ionizer, it achieves the fastest charge removal of 0.3 sec. or less*² ($\pm 1,000\text{ V} \rightarrow \pm 100\text{ V}$).

*1: Spot diameter of $\phi 15\text{ mm}$ $\phi 0.591\text{ in}$ or less *2: Based on research conducted by our company as of March 2016.

Supports airless and low-pressure charge removal, which means charge removal is possible without blowing away tiny work pieces.

Free head placement is possible thanks to flexible cable with internal air tube.

Air supply port angle can be adjusted.

■ER-X001 high-voltage unit



Joint for $\phi 6\text{ mm}$ $\phi 0.236\text{ in}$ air tube
360° angle adjustment

Applications

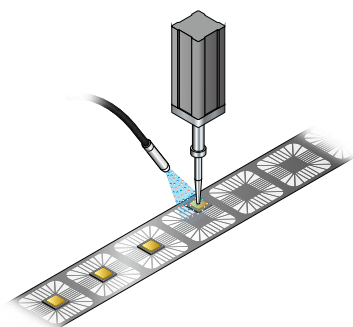

Preventing electrostatic damage during bonding

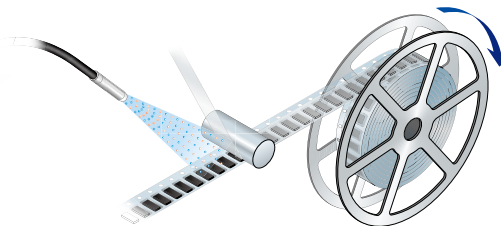

High-speed charge removal on a taping machine

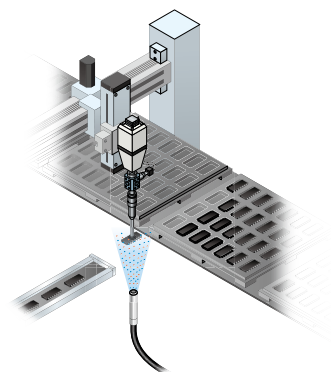

Airless charge removal of minute components on a conveyor belt

Dual head configuration for enhanced charge area and layout expansion



ER-XC02



- Different heads can be combined.
* The new-type controller, ER-XC02, allows simultaneous connection of the bar type head and spot type head.
- Charge removal is possible with a layout that places heads on either side of the workpiece.
- The charge removal efficiency can be increased by synchronizing the two heads.

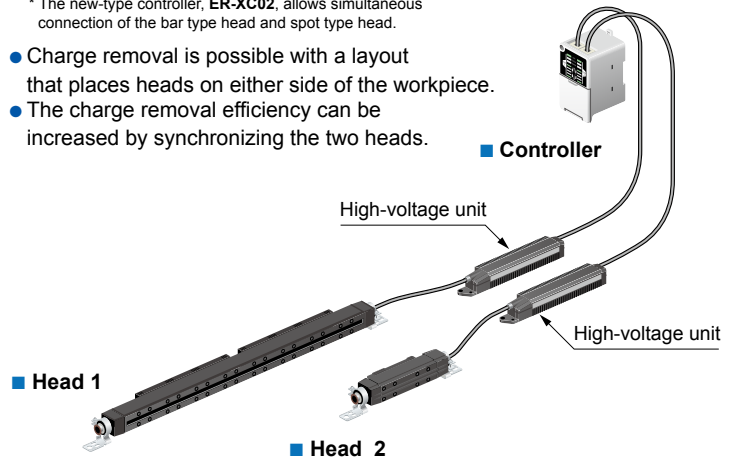

Equipped with charging function

The charging function is useful when charging paper or parts for static electricity adsorption transport.

- Notes: 1) Head 2 performs the ordinary charge neutralizing operation.
2) The ER-X001 cannot use the charging function.
(Discharge operation stops.)

All-in-one model equipped with various functions for optimal removal of charge

Level meter indicator (green)

Indicates static buildup around the head or the amount of ion generated from the head.

Discharge control switch

Turn ion generation on and off.

SET UP button

Determines the settings of discharge frequency and ion balance.

Discharge control input

Turn ion generation on and off from an external device.

Alarm output, error output

Report maintenance timing and malfunctions to an external device.

Discharge indicator (green)

Lights up during discharge.

CHECK indicator (orange)

Lights up when dirt, wear, etc. of the discharge needle is detected.

ERROR indicator (red)

Lights up when abnormal discharge is detected.

Discharge frequency setting switch

Select from eight ion generation frequencies ranging from 100 Hz to 1 Hz according to your application. Head 1 can be used as a charger when the discharge frequency setting switch for Head 1 is set to "+ Charge" or "- Charge."

- Notes: 1) Head 2 performs the ordinary charge removal operation.
2) The ER-X001 cannot use the charging function.
(Discharge operation stops.)

Ion balance setting switch







Adjust the ion balance to any of 15 levels according to the strength of the charge on the workpieces.

Various setting switch

- **Check level changeover switch**
Set the maintenance notification level to "standard" or "high-sensitivity."
- **Ion balance control switch**
Enable or disable the ion balance auto control function.
- **Indicator changeover switch**
Set the level meter indicator display mode to "charge strength display" or "ion generation volume display."
- **2 heads control switch**
Set the ion generation timing for the two heads to "synchronize" or "inverse."
- **Error output changeover switch**
Set the error output condition to "generation of abnormal discharge" or "generation of abnormal discharge + discharge stop setting ON."

ORDER GUIDE

Heads Head connection cable is not supplied with the head. Please order it separately.

Type	Appearance	Charge removal time (±1,000 V→±100 V)	Ion balance	Effective charge removal width	Model No.
Spot type		0.3 second or less (Note 1), 0.5 second or less (Note 2)	±30 V or less (Note 2, 3)	50 mm 1.969 in approx.	ER-X001 (Note 4)
High and low temperature resistant		1 second or less (Note 2)		80 mm 3.150 in approx.	ER-X008 (Note 4) NEW ER-X008HC (Note 5)
				160 mm 6.299 in approx.	ER-X016 NEW ER-X016HC (Note 5)
Bar type				320 mm 12.598 in approx.	ER-X032 NEW ER-X032HC (Note 5)
					480 mm 18.898 in approx.
High and low temperature resistant					640mm 25.197 in approx.

- Notes: 1) Typical value in condition of discharge distance 50 mm **1.969 in**, center of the product, discharge frequency 50 Hz and air supply 60 l/min.(0.3 MPa).
 2) Typical value in condition of discharge distance 100 mm **3.937 in** (**ER-X001**: 50 mm **1.969 in**), center of the product, discharge frequency 50 Hz (**ER-X□HC**: 30 Hz) and no air supply.
 3) Ion balance refers to the average value of plus and minus. The specification value is the typical one in condition used when ambient temperature change is less than ±10 °C, ion balance is set after 30 minutes from the discharge start, the ion balance control function is set ON.
 4) The **ER-X001** and **ER-X008** must be combined with the new-type **ER-XC02** controller (produced from April 2014 on).
 For the [Identification of previous-type and new-type controllers and for the combination with the head](#), refer to p.17.
 5) The **ER-X□HC** high / low temperature resistant type head can be used under temperatures from -60 to +200 °C **-76 to +392 °F**. Be sure to use this head in combination with the new-type controller, **ER-XC02** (produced from April 2016 on).
 For the [Identification of previous-type and new-type controllers and for the combination with the head](#), refer to p.17.

ORDER GUIDE

Controller Please order power cable or AC adapter separately.

Type	Appearance	Model No.	Number of heads connected	Output
Standard type		ER-XC02	Max. 2 units	PhotoMOS relay

Head connection cable Head connection cable is not supplied with the head. Please order it separately.

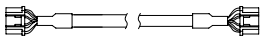
Appearance	Model No.	Description
	ER-XCCJ2H	Length: 2 m 6.562 ft , Net weight: 120 g approx.
	ER-XCCJ5H	Length: 5 m 16.404 ft , Net weight: 290 g approx.
	ER-XCCJ10H (Note)	Length: 10 m 32.808 ft , Net weight: 560 g approx.
		Cabtyre cable with both connector

Note: Cannot be used with the high and low temperature resistant type head **ER-X□HC**.

OPTIONS

Designation	Model No.	Description
Power cable	ER-XCC2	Length: 2 m 6.562 ft , Net weight: 80 g approx.
	ER-XCC5	Length: 5 m 16.404 ft , Net weight: 190 g approx.
AC adapter	ER-XAPS-EX	IN: 100-240 V AC, 50 / 60 Hz OUT: 24 V DC, 1.5 A Ambient temperature: 0 to +40 °C +32 to +104 °F Ground wire: 3.7 m 12.139 ft AC cable: 1 pc., Cable length 1.8 m 5.906 ft , Rating 125 V AC (Note 1) Wiring connector terminals: 6 pcs.
	ER-XAPS	
AC cable	CN-ACCN-C2	AC cable (conforming to CCC), Length: 2 m 6.562 ft
	CN-ACKR-C2	AC cable (conforming to KTL), Length: 2 m 6.562 ft
Discharge needle unit	ER-XANT	For ER-X016/X032/X048/X064 . (Note 2) Unit with replacement tungsten needles: 1 pc.
	ER-XANT1	For ER-X001 . Unit with replacement tungsten needles: 1 pc.
	ER-XANT2	For ER-X008 . (Note 2) Unit with replacement tungsten needles: 1 pc.
	NEW ER-XANTHC	For ER-X016HC/X032HC/X048HC/X064HC . Unit with replacement tungsten needles: 1 pc.
	NEW ER-XANT2HC	For ER-X008HC . Unit with replacement tungsten needles: 1 pc.
Discharge part protective cover	ER-XACVR	For ER-X016/X032/X048/X064 . (Note 2) Enables to prevent electric shock by mounting to the heads. 2 pcs per set. (Note 3) Material: Polycarbonate, Weight: 20 g approx. (1 set) * No effect on charge removal capacity of the heads by mounting a discharge part protection cover

Notes: 1) Rating of the AC cable is 125 V AC. If the voltage used exceeds 125 V AC, prepare a proper cable by yourself or purchase our optional cable **CN-ACCN-C2** or **CN-ACKR-C2**. And, the AC cable is not enclosed with **ER-XAPS-EX**.

2) Cannot be used with the high and low temperature resistant type head **ER-X□HC**.

3) The number of set(s) you need depends on the head model No.

Model No.	ER-X016	ER-X032	ER-X048	ER-X064
No. of set (2 pcs per set)	1 set	2 sets	3 sets	4 sets

Power cable

- **ER-XCC□**

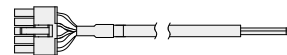

AC adapter

- **ER-XAPS-EX**



- **ER-XAPS**



Discharge needle unit

- **ER-XANT**
- **ER-XANTHC**



- **ER-XANT1**



- **ER-XANT2**
- **ER-XANT2HC**

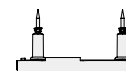

Discharge part protective cover

- **ER-XACVR**

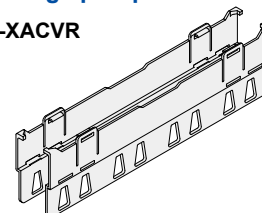

SPECIFICATIONS

Heads

Item	Type	Bar type				
	Model No.	ER-X001	ER-X008	ER-X016	ER-X032	ER-X048
Effective charge removal width	50 mm 1.969 in approx.	80 mm 3.150 in approx.	160 mm 6.299 in approx.	320 mm 12.598 in approx.	480 mm 18.898 in approx.	640 mm 25.197 in approx.
Charge removal time ($\pm 1,000$ V \rightarrow ± 100 V)	0.3 sec. or less (Note 1), 0.5 sec. or less (Note 2)	1 sec. or less (Note 2)				
Ion balance	± 30 V or less (Note 2, 3)					
Discharge method	Pulse AC method					
Discharge frequency	50 Hz / 20 Hz	50 Hz / 30 Hz / 20 Hz / 10 Hz / 5 Hz / 1 Hz	100 Hz / 70 Hz / 50 Hz / 30 Hz / 20 Hz / 10 Hz / 5 Hz / 1 Hz (Note 4)			
Discharge output voltage	$\pm 7,000$ V approx.					
Ozone generation	0.01 ppm or less (Note 2)					
Maximum air pressure	0.5 MPa					
Applicable fluid	Air (dried clean air) (Note 5)					
Operating altitude	2,000 m 6561.68 ft or less (Note 6)					
Ambient temperature	0 to +50 °C +32 to +122 °F (ER-X001: 0 to +40 °C +32 to +104 °F) (No dew condensation), Storage: -10 to +65 °C +14 to +149 °F					
Ambient humidity	35 to 65 % RH, Storage: 35 to 85 % RH					
Vibration resistance	10 to 55 Hz (ER-X001: 10 to 150 Hz) frequency, 0.75 mm 0.030 in double amplitude in X, Y and Z directions for two hours each					
Shock resistance	100 m/s ² acceleration (10 G approx.), in X, Y and Z directions three times each					
Enclosure grounding method	Floating					
Material	Main unit enclosure: PPS, Stainless steel (SUS), Head mounting bracket: Stainless steel (SUS), Discharge needle: PC, PPS, Tungsten (Note 7) [ER-X001 – Main unit enclosure: Stainless steel (SUS), Head mounting bracket: Stainless steel (SUS), Discharge needle: PFA, Tungsten]					
Length of high-voltage cable	1.2 m 3.937 ft	0.5 m 1.640 ft	0.5 m 1.640 ft (Note 4)			
Net weight	370 g approx.	330 g approx.	410 g approx.	530 g approx.	650 g approx.	780 g approx.
Accessory	Head mounting bracket (mounted at the factory)					

Item	Type	High and low temperature resistant				
	Model No.	ER-X008HC	ER-X016HC	ER-X032HC	ER-X048HC	ER-X064HC
Effective charge removal width	80 mm 3.150 in approx.	160 mm 6.299 in approx.	320 mm 12.598 in approx.	480 mm 18.898 in approx.	640 mm 25.197 in approx.	
Charge removal time ($\pm 1,000$ V \rightarrow ± 100 V)	1 sec. or less (Note 2)					
Ion balance	± 30 V or less (Note 2, 3)					
Discharge method	Pulse AC method					
Discharge frequency	30 Hz (Note 8)					
Discharge output voltage	$\pm 7,000$ V approx.					
Ozone generation	0.01 ppm or less (Note 2)					
Maximum air pressure	0.1 MPa					
Applicable fluid	Air (dried clean air) (Note 5)					
Operating altitude	2,000 m 6561.68 ft or less (Note 6)					
Ambient temperature	Head: -60 to +200 °C -76 to +392 °F (No dew condensation or icing) (Note 9), Storage: -10 to +65 °C +14 to +149 °F High voltage unit: 0 to +50 °C +32 to +122 °F (No dew condensation), Storage: -10 to +65 °C +14 to +149 °F					
Ambient humidity	35 to 65 % RH, Storage: 35 to 85 % RH					
Vibration resistance	10 to 55 Hz frequency, 0.75 mm 0.030 in double amplitude in X, Y and Z directions for two hours each					
Shock resistance	100 m/s ² acceleration (10 G approx.), in X, Y and Z directions three times each					
Enclosure grounding method	Floating					
Material	Main unit enclosure: PPS, Stainless steel (SUS), Head mounting bracket: Stainless steel (SUS), Discharge needle: PC, PPS, Tungsten, Main unit enclosure of high-voltage unit: ABS					
Length of high-voltage cable	Heat-resistant shielded cable, 1.8 m 5.906 ft					
Net weight	420 g approx.	490 g approx.	620 g approx.	760 g approx.	900 g approx.	
Accessories	$\phi 6$ 0.236-4 Air tube joint: 1 pc., Seal cap: 1 pc., Head mounting bracket (mounted at the factory)					

- Notes: 1) Typical value in condition of discharge distance 50 mm **1.969 in**, center of the product, discharge frequency 50 Hz and air supply 60 l/min.(0.3 MPa).
2) Typical value in condition of discharge distance 100 mm **3.937 in** (ER-X001: 50 mm **1.969 in**), center of the product, discharge frequency 50 Hz (ER-X001HC: 30 Hz) and no air supply.
3) Ion balance refers to the average value of plus and minus. The specification value is the typical one in condition used when ambient temperature change is less than ± 10 °C, ion balance is set after 30 minutes from the discharge start, the ion balance control function is set ON.
4) The high-voltage cable is also available in lengths of 1 m **3.281 ft** and 2 m **6.562 ft**. The discharge frequency of 1 m **3.281 ft** / 2 m **6.562 ft** cables is 50 / 30 / 20 / 10 / 5 / 1 Hz. For details, please contact our sales office.
5) The dried clean air is the air dried (dew point: equivalent of -20 °C **-4 °F**) and filtered (mesh-size: equivalent of 0.01 μ m).
6) Do not use or store in an environment that has been pressurized to an air pressure higher than the atmospheric pressure at 0 m.
7) Silicon needles (ER-X016S, ER-X032S and ER-XANS) are also available. For details, please contact our sales office.
8) Set the discharge frequency to 30 Hz. Do not use any other frequency.
9) Discoloration of the head may occur when used under high temperatures, but it does not affect the charge removal performance.

SPECIFICATIONS

Allowable ambient temperature of high and low temperature resistant type head ER-X□HC and its installation

When installing, make sure to expose a section measuring 500 mm **19.685 in** or more to the normal temperature area as shown below for the protection of the high-voltage unit.

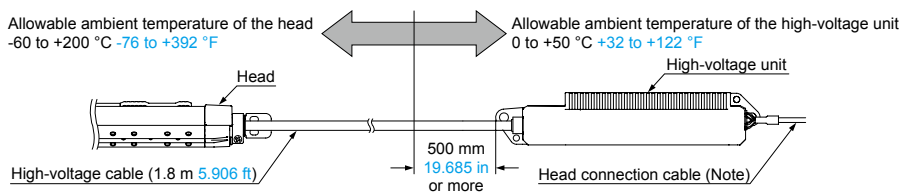

Note: The high and low temperature resistant type **ER-X□HC** cannot be connected with the **ER-XCCJ10H** head connection cable (10 m **32.808 ft** in length).

Controller

Item	Type	Controller
	Model No.	ER-XC02
Number of heads connected		Maximum 2 units
Supply voltage		24 V DC $\pm 10\%$
Current consumption		450 mA or less when connecting 1 heads, 800 mA or less when connecting 2 heads
Indicator		Displays status of Head 1 and 2
	DSC (Discharge)	Green LED (lights up when discharging)
	CHECK	Orange LED (lights up when dirt, wear, etc. of the discharge needle is detected)
	ERROR	Red LED (lights up when abnormal discharge is detected)
	Level meter	Green LED (5 levels, lights up depending on amount of the charge or ion generation)
Output [ALARM ERROR COM (Common)]		PhotoMOS relay output • Maximum load current: 100 mA • Applied voltage: 30 V DC or less (between output-output common) • Residual voltage: 1.5 V or less (at load current of 100 mA)
	Output operation	ALARM: ON when dirt or wear of the discharge needle is detected; OFF when operation is normal. ERROR: OFF when abnormal discharge is detected; ON when operation is normal.
	Short-circuit protection	Incorporated (automatic reset type)
Discharge control input (DSC OFF)		Discharge allowed: Open, Discharge halt: 24 V or 0 V shorted
Contamination level		2
Oversvoltage category		I
Elevation		2,000 m 6561.68 ft or less (Note)
Ambient temperature		0 to +50 °C +32 to +122 °F (No dew condensation), Storage: -10 to +65 °C +14 to +149 °F
Ambient humidity		35 to 65 % RH, Storage: 35 to 85 % RH
Voltage withstandability		1,000 V AC for one min. between all supply terminals connected together and enclosure 500 V AC for on min. between supply terminals and F.G.
Insulation resistance		20 M Ω , or more, with 250 V megger between all supply terminals connected together and enclosure
Vibration resistance		10 to 150 Hz frequency, 0.75 mm 0.030 in double amplitude in X, Y and Z directions for two hours each
Shock resistance		100 m/s ² acceleration (10 G approx.) in X, Y and Z directions three times each
Enclosure grounding method		Floating
Material		Enclosure: ABS
Weight		130 g approx.
Accessories		Power supply / I/O connector: 1 set (Housing 5557-10R, Terminal 5556TL [manufactured by Molex]) Ground wire (3.7 m 12.139 ft approx.): 1 pc.

Note: Do not use or store in an environment that has been pressurized to an air pressure higher than the atmospheric pressure at 0 m.

CHARGE REMOVAL CHARACTERISTICS (TYPICAL)

Please contact our office for details on data that is not listed here.

Measured using a 150 × 150 mm 5.906 × 5.906 in CPM (charge plate monitor). (At center of CPM)

Common to ER-X001/X008

Air flow

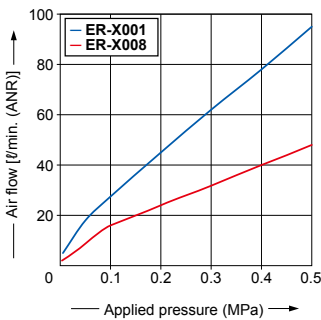

ER-X001

Correlation between charge removal distance and charge removal time (50 Hz)

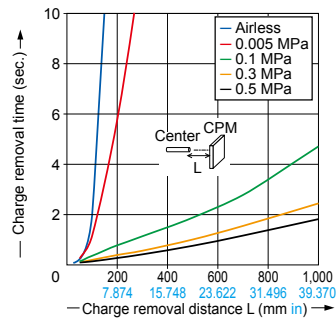

Correlation between charge removal distance and charge removal time (20 Hz)

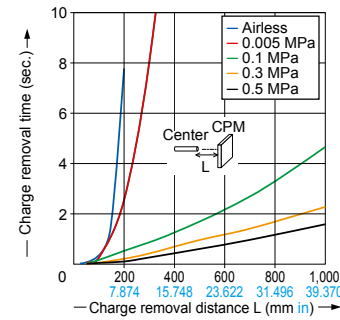

ER-X001

Charge removal field (airless, 50 Hz)

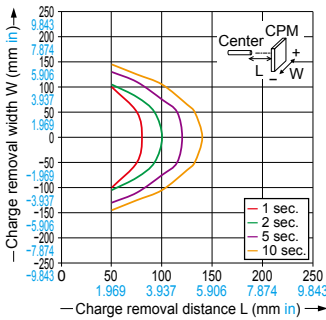

Charge removal field (airless, 20 Hz)

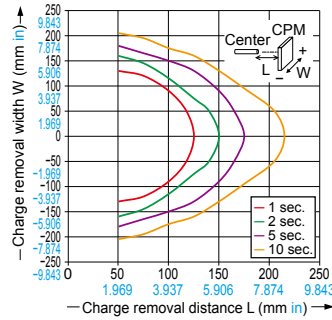

Charge removal field (0.005 MPa, 50 Hz)

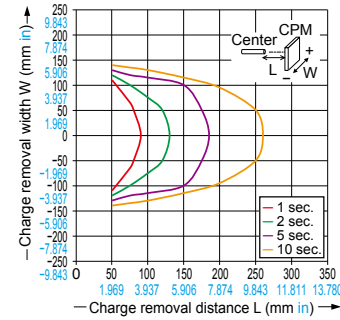

Charge removal field (0.005 MPa, 20 Hz)

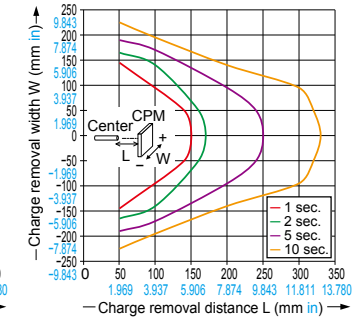

ER-X001

Charge removal field (0.5 MPa, 50 Hz)

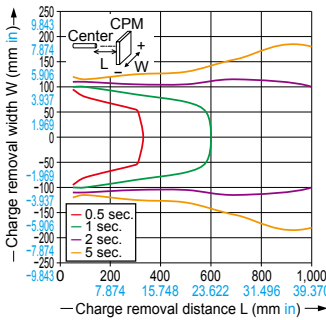

Charge removal field (0.5 MPa, 20 Hz)

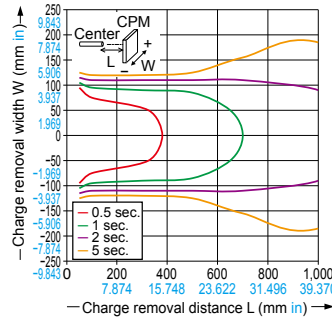

ER-X008

Correlation between charge removal distance and charge removal time (50 Hz)

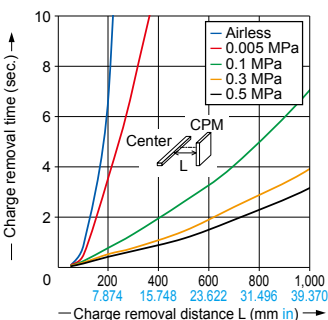

Correlation between charge removal distance and charge removal time (10 Hz)

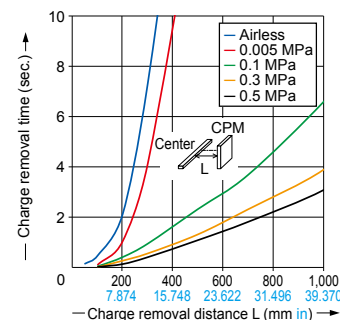

Charge removal field (vertical direction, airless, 50 Hz)

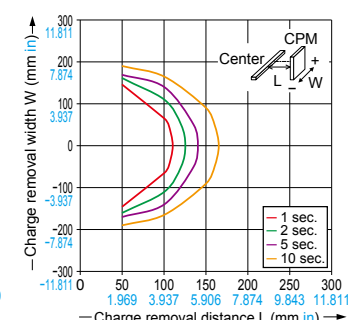

Charge removal field (vertical direction, airless, 10 Hz)

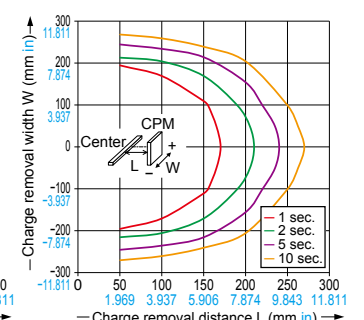

CHARGE REMOVAL CHARACTERISTICS (TYPICAL)

Please contact our office for details on data that is not listed here.

Measured using a 150 × 150 mm 5.906 × 5.906 in CPM (charge plate monitor). (At center of CPM)

ER-X008

Charge removal field (vertical direction, 0.005 MPa, 50 Hz)

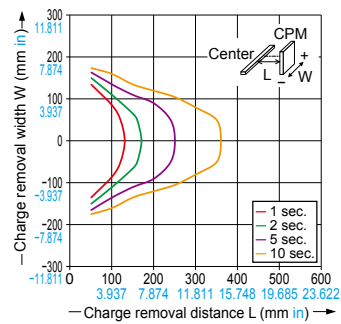

Charge removal field (vertical direction, 0.005 MPa, 10 Hz)

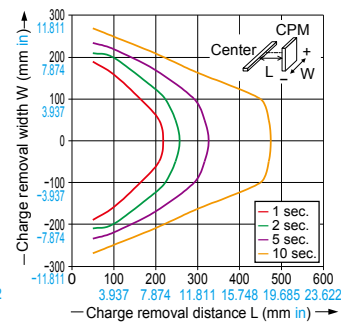

Charge removal field (vertical direction, 0.5 MPa, 50 Hz)

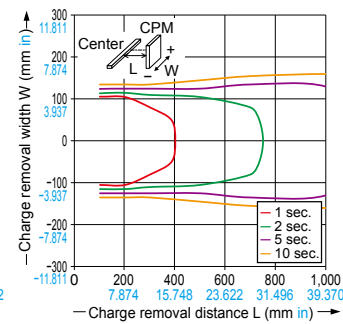

Charge removal field (vertical direction, 0.5 MPa, 10 Hz)

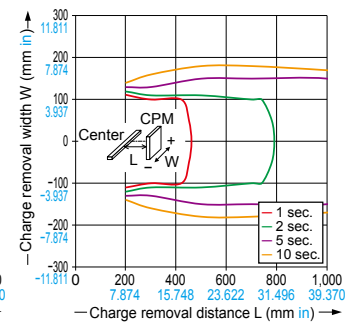

Common to ER-X016/X032/X048/X064

Air flow

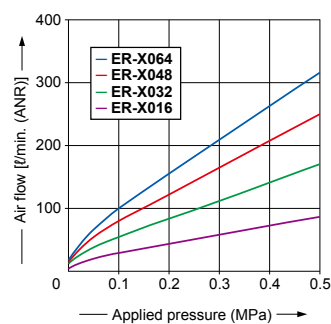

Correlation between charge removal distance and charge removal time (50 Hz)

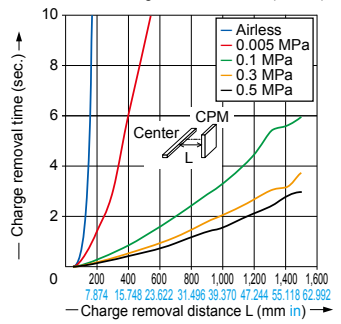

Correlation between charge removal distance and charge removal time (10 Hz)

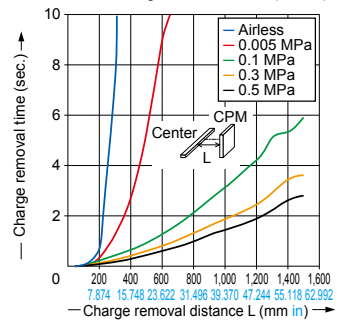

Correlation between charge removal distance and charge removal time (1 Hz)

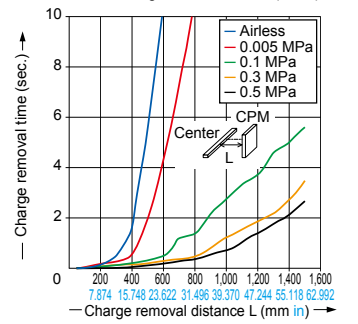

Common to ER-X016/X032/X048/X064

Charge removal field (horizontal direction, airliss, 50 Hz)

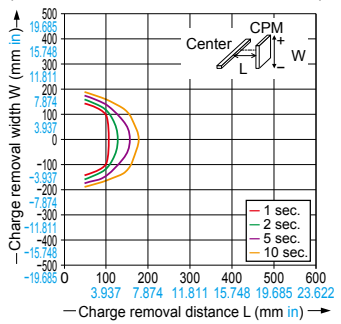

Charge removal field (horizontal direction, airliss, 10 Hz)

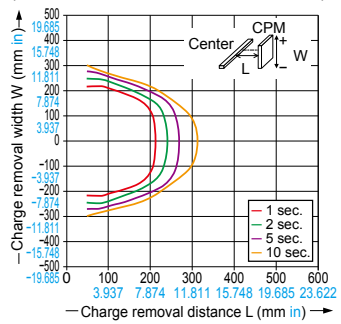

Charge removal field (horizontal direction, airliss, 1 Hz)

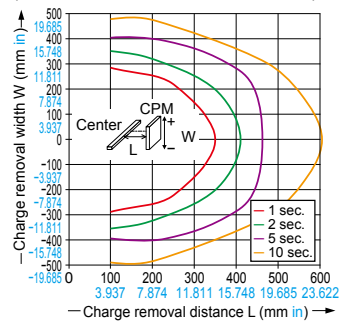

Charge removal field (horizontal direction, 0.005 MPa, 50 Hz)

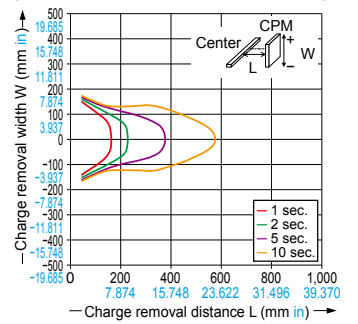

Common to ER-X016/X032/X048/X064

Charge removal field (horizontal direction, 0.005 MPa, 10 Hz)

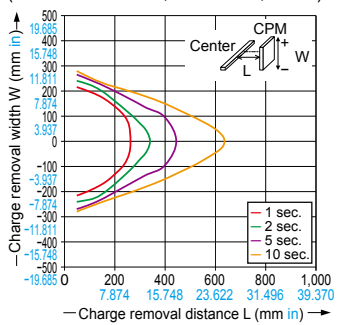

Charge removal field (horizontal direction, 0.005 MPa, 1 Hz)

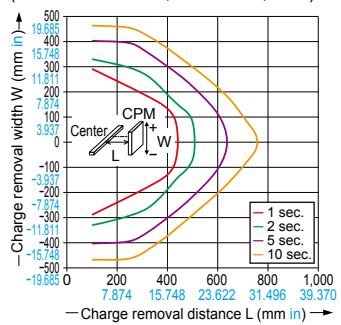

Charge removal field (horizontal direction, 0.5 MPa, 50 Hz)

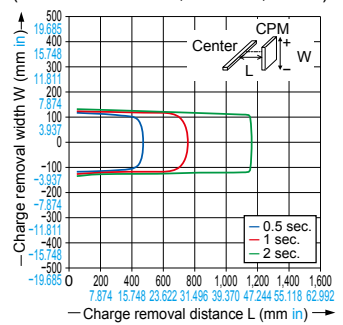

Charge removal field (horizontal direction, 0.5 MPa, 10 Hz)

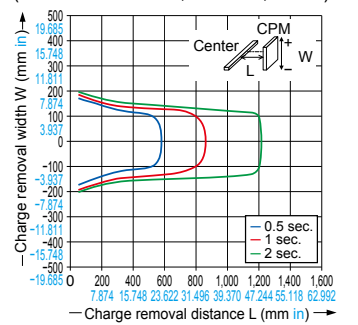

CHARGE REMOVAL CHARACTERISTICS (TYPICAL)

Please contact our office for details on data that is not listed here.

Measured using a 150 × 150 mm 5.906 × 5.906 in CPM (charge plate monitor). (At center of CPM)

Common to ER-X016/X032/X048/X064

Charge removal field (horizontal direction, 0.5 MPa, 1 Hz)

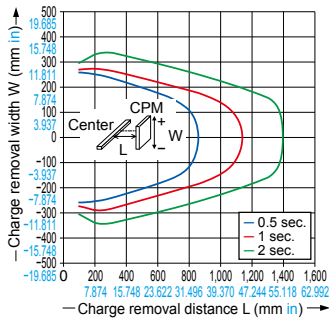

ER-X032

Charge removal field (vertical direction, airless, 50 Hz)

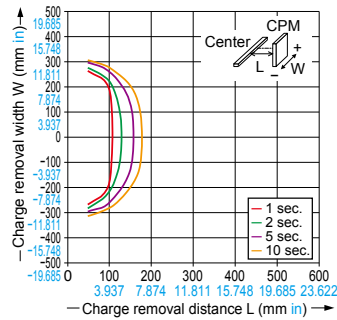

Charge removal field (vertical direction, airless, 10 Hz)

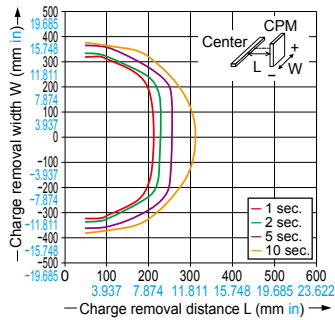

Charge removal field (vertical direction, airless, 1 Hz)

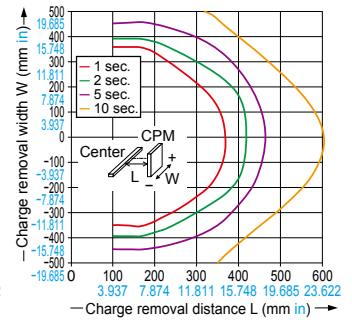

ER-X032

Charge removal field (vertical direction, 0.005 MPa, 50 Hz)

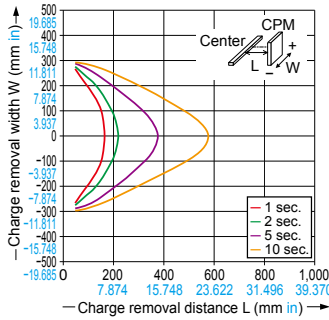

Charge removal field (vertical direction, 0.005 MPa, 10 Hz)

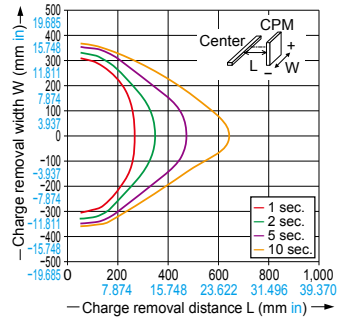

Charge removal field (vertical direction, 0.005 MPa, 1 Hz)

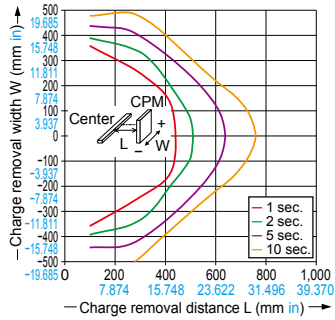

Charge removal field (vertical direction, 0.5 MPa, 50 Hz)

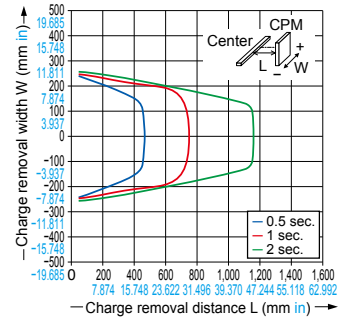

ER-X032

Charge removal field (vertical direction, 0.5 MPa, 10 Hz)

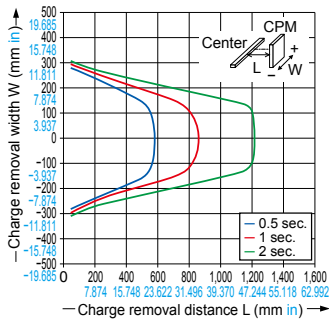

Charge removal field (vertical direction, 0.5 MPa, 1 Hz)

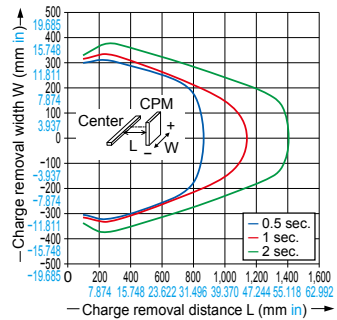

ER-X064

Charge removal field (vertical direction, airless, 50 Hz)

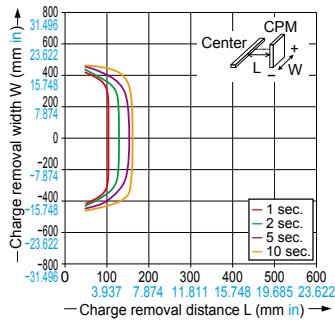

Charge removal field (vertical direction, airless, 10 Hz)

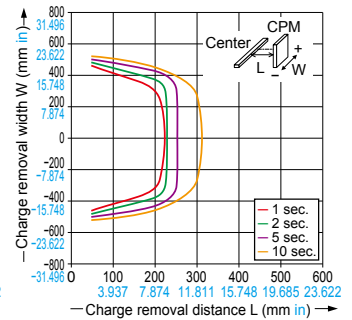

ER-X064

Charge removal field (vertical direction, airless, 1 Hz)

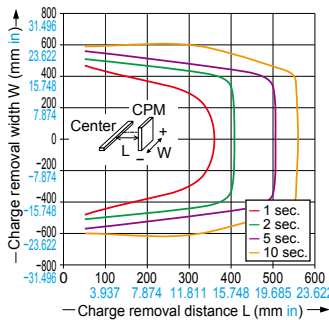

Charge removal field (vertical direction, 0.005 MPa, 50 Hz)

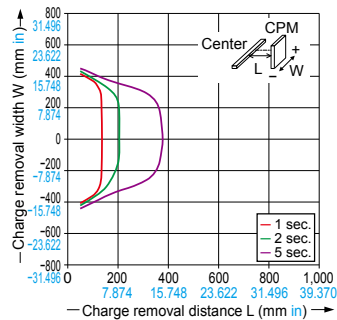

Charge removal field (vertical direction, 0.005 MPa, 10 Hz)

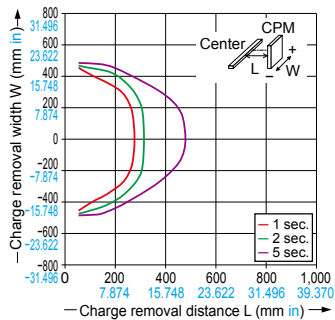

Charge removal field (vertical direction, 0.005 MPa, 1 Hz)

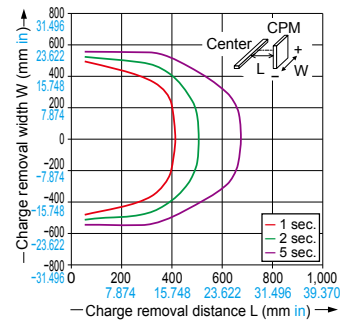

CHARGE REMOVAL CHARACTERISTICS (TYPICAL)

Please contact our office for details on data that is not listed here.

Measured using a 150 × 150 mm 5.906 × 5.906 in CPM (charge plate monitor). (At center of CPM)

ER-X064

Charge removal field
(vertical direction, 0.5 MPa, 50 Hz)

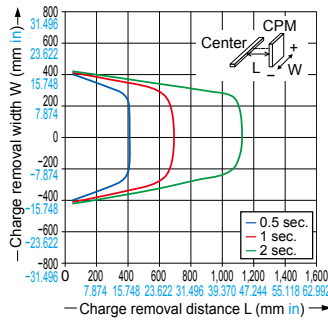

Charge removal field
(vertical direction, 0.5 MPa, 10 Hz)

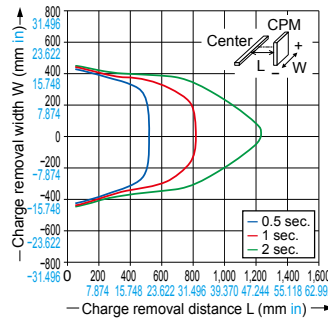

Charge removal field
(vertical direction, 0.5 MPa, 1 Hz)

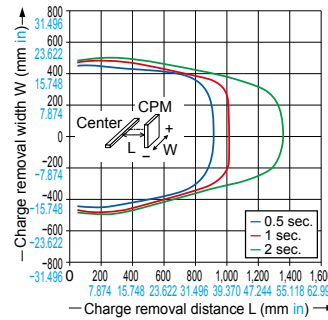

Common to ER-X□HC

Air flow

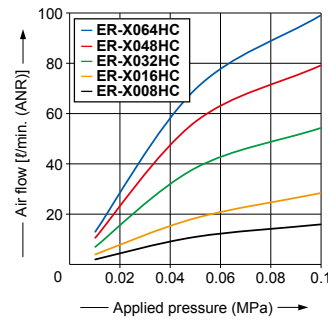

ER-X008HC

Correlation between charge removal distance and charge removal time (30 Hz)

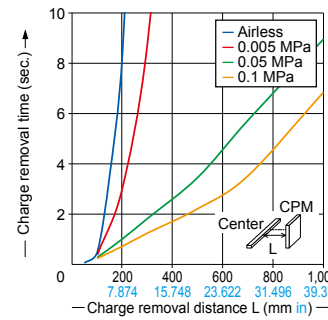

ER-X016HC

Correlation between charge removal distance and charge removal time (30 Hz)

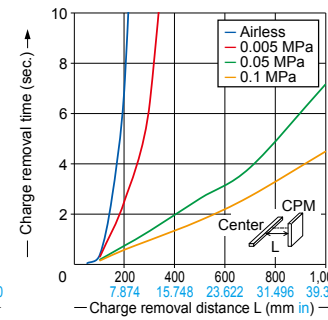

Please contact our office for details on data that is not listed here.

I/O CIRCUIT AND WIRING DIAGRAMS

New-type controller (produced from April 2014 on)

Notice: Products manufactured from April 2014 and before April 2016 cannot be used with the high and low temperature resistant type head ER-X008HC. For the Identification of previous-type and new-type controllers and for the combination with the head, refer to p.17.

Power connector pin arrangement



(Front view)

Housing: 5569-10A
[Manufactured by Molex]

Terminal No.	Terminal name	Color code
1	0 V	Blue
2	COM(-)	-
3	Discharge control input	Pink
4	COM(OUT)	Violet
5	F.G. terminal	Green / Yellow
6	24 V	Brown
7	COM(+)	-
8	COM(IN)	White
9	Alarm output	Orange
10	Error output	Black

Note: Color code refers to cable colors of an optional power supply cable.

When connecting the output to negative common

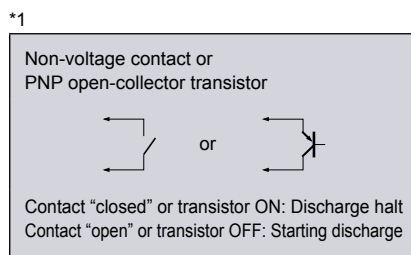
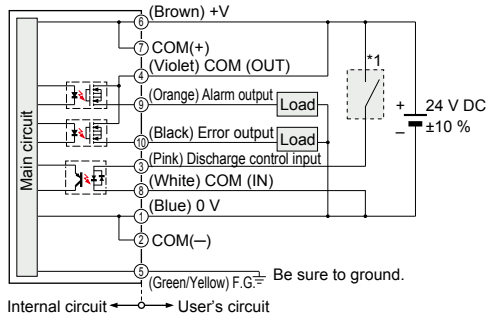

Notes: 1) Be sure to ground the F.G. terminal. If F.G. terminal is not connected properly, it may cause electric shock. In the case of ER-X001, the head mounting bracket and F.G. terminal are internally connected.
2) To stop discharge, turn ON the discharge control input for 20 ms or longer. To start discharge, turn OFF (open) the discharge control input. Discharge will start in 20 ms.

When connecting the output to positive common

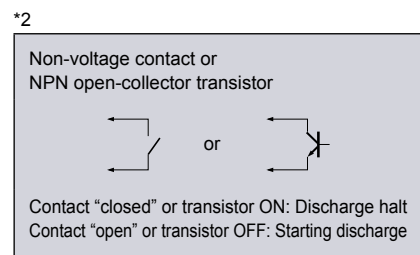
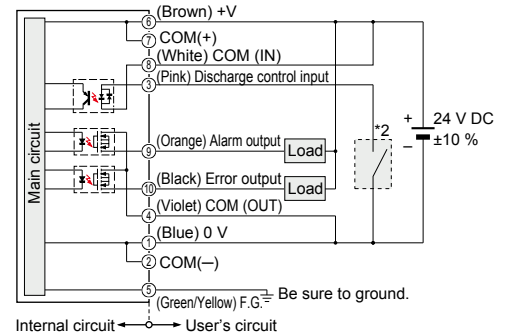

Previous-type controller (produced before March 2014)

Notice: Products manufactured before March 2014 cannot be used with ER-X001, ER-X008 and the high and low temperature resistant type head ER-X□HC. For the Identification of previous-type and new-type controllers and for the combination with the head, refer to p.17.

Power connector pin arrangement



(Front view)

Housing: 5569-10A
[Manufactured by Molex]

Terminal No.	Terminal name	Color code
1	0 V	Blue
2	COM(-)	-
3	Discharge control input	Pink
4	COM(OUT)	Violet
5	F.G. terminal	Green / Yellow
6	24 V	Brown
7	COM(+)	-
8	-	White
9	Alarm output	Orange
10	Error output	Black

Note: Color code refers to cable colors of an optional power supply cable.

When connecting the output to negative common

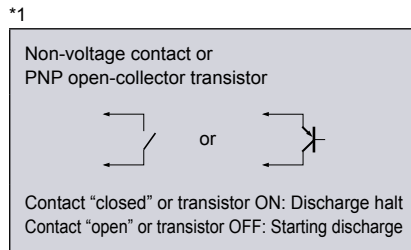
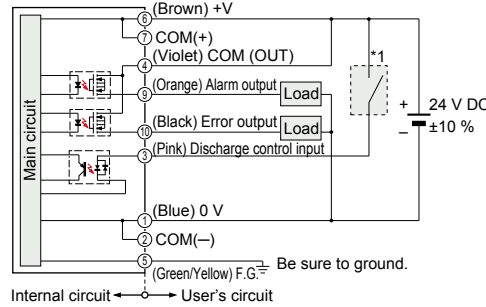

Notes: 1) Be sure to ground the F.G. terminal. If F.G. terminal is not connected properly, it may cause electric shock.
2) To stop discharge, turn ON the discharge control input for 20 ms or longer. To start discharge, turn OFF (open) the discharge control input. Discharge will start in 20 ms.

When connecting the output to positive common

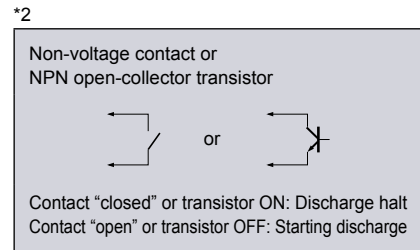
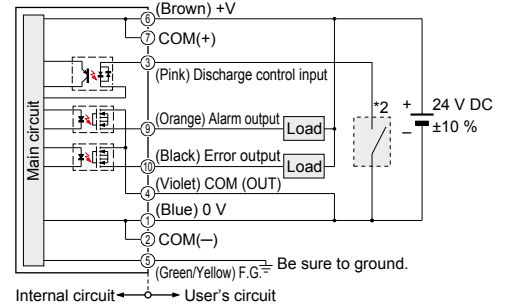

PRECAUTIONS FOR PROPER USE



- Never use this product as device for personnel protection.
- In case of using devices for personnel protection, use products which meet laws or standards, such as OSHA, ANSI or IEC etc., for personnel protection applicable in each region or country.
- This product produces high voltages.
- Do not use this product in places where there may be a danger of flammable or combustible items being present.
- To prevent electric shock and to conduct proper discharge, be sure to ground a frame ground (F.G.) terminal of a controller.
- Do not place hands near the discharge needle. Doing so may cause electric shock.
- Since the tip of the discharge needle is sharp, take sufficient care in handling the discharge needle, or injuries may result.
- The high-voltage cable between the head and the high-voltage unit must be fixed and the minimum bend radius is R30 mm **R1.181 in** or more. In case of using at the bend radius R30 mm **R1.181 in** or less and using at moving part may cause fire and break down, etc. of the high-voltage cable.
- Clean the discharge needle regularly (about once a week). Otherwise, optimum charge removal performance may not be achieved, and accidents or operating problems may occur.
- If this product is used in a confined space, ozone emitted from this product may be detrimental. Be sure to provide ventilation.
- Do not direct ionized air toward the face. Ozone may cause irritation to places such as the nose and throat.
- When the product has been used under very high or low temperatures, do not touch the product with a bare hand. Failure to observe this caution can result in burn or injury. Be sure to let the product cool sufficiently when touching the product for maintenance or other purposes.

- When using as a CSA and UL compliant product, use a CLASS 2 CSA/UL certified power supply, or a CSA/UL certified power supply that has been evaluated as a Limited Power Source as specified in CAN/CSA-C22.2 No.60950-1/UL60950-1.
- This product has been developed / produced for industrial use only.
- Do not use this product for purposes other than electric charge removal.
- Do not use this product in environments which are outside the specification range, otherwise operating problems or damage may occur. In addition, the operating life of the product may become significantly reduced.
- This product is a precision device. Do not apply a shock to it by dropping, for example. Accidents or operating problems may occur.
- Never disassemble, repair or modify this product. Accidents or operating problems may occur.
- Do not throw this product in fire. It may explode or toxic fumes may be generated.
- Do not run the wires together with high-voltage lines or power lines or put them in the same raceway. This can cause malfunction due to induction.
- Verify that the supply voltage variation is within the rating.
- In case using switching regulator, be sure to connect F.G. terminal.
- When connecting / removing the head or performing wiring or inspection work, be sure to turn off the power first. Not doing so may result in accidents, electric shock or operating problems.
- After connecting the cables, check that the connections are correct before turning on the power. If the cables are connected incorrectly, operating problems or accidents may occur.
- Do not use a cable with any damage such as cracks or splitting. Risk of accidents and failure.
- Avoid use in a location with significant steam or dust, or in a location where the product may come in direct contact with water, oil, or welding spatter.
- Do not touch the discharge needle with hard objects such as tools. If the discharge needle becomes broken, it will not provide sufficient charge removal performance, and moreover operating problems or accidents may occur.
- During installation, fasten the product securely. If it is not securely fastened or it is subjected to continuous vibration or shock, accidents or operating problems may result.
- Power cable that are 0.15mm² or more and 30 m **98.425 ft** or less in total length for wiring. Also, keep the wiring as short as possible in order to prevent noise.
- When disposing of this product, treat it appropriately as industrial waste.
- After starting discharge, it takes 30 minutes approx. for charge removal performance to stabilize. Therefore, wait 30 minutes before adjusting ion balance.
- Use the correct combination of head, discharge needle unit and controller.

• NRTL (National Recognized Testing Laboratories) certification means that the product was tested by the third-party private testing organization (TÜV SÜD America) authorized by the Occupational Safety and Health Administration (OSHA) and found to comply with the safety standards (ANSI/UL) established by American National Standards Institute and the standards (CAN/CSA) established by Canadian Standards Association.

Identification of previous-type and new-type controllers and combination with the head

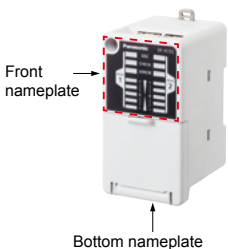

Combination			New-type controller (Note)		Previous-type controller (Note)
			Produced from April 2016 on	Produced from April 2014 and before April 2016	Produced before March 2014
			<ul style="list-style-type: none"> • Front nameplate <ul style="list-style-type: none"> • Bottom nameplate 	<ul style="list-style-type: none"> • Front nameplate <ul style="list-style-type: none"> • Bottom nameplate 	<ul style="list-style-type: none"> • Front nameplate <ul style="list-style-type: none"> • Bottom nameplate
Head	Spot type	ER-X001	OK	OK	Cannot be used
		ER-X008			Cannot be used
	Bar type	ER-X016			
		ER-X032	OK	OK	OK
		ER-X048			
		ER-X064			
	High and Low temperature resistant	ER-X008HC		Cannot be used	
		ER-X016HC			
		ER-X032HC	OK	OK	Cannot be used
		ER-X048HC			
		ER-X064HC			

Note: The layout of the power supply connector pins differ between new-type controllers and previous-type head controllers. For details refer to "I/O CIRCUIT AND WIRING DIAGRAMS" (p.16).

PRECAUTIONS FOR PROPER USE

Mounting

Head installation

- Using 2 M4 screws or 1 M6 screw, mount the head onto the equipment housing.
- Loosen the angle adjustment screw, adjust the head angle, and then fasten the head with the tightening torque of 0.5 N·m or less.
- Position the head mounting bracket of the **ER-X001** at least 20 mm **0.787 in** away from the tip of the head. The tightening torque for the head fixing screw must be 0.5 N·m or less.

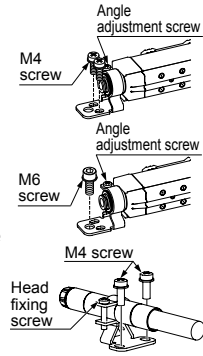

After mounting and setting up the head, set the controller according to the procedures described in the instruction manual in order to properly remove electrical charge.

- Notes: 1) Be sure to ground the equipment housing onto which the head is mounted.
- 2) The distance between the head and the charge removing object should be 30 mm **1.181 in** or more. If the static buildup of the charge removing object is 30 kV or more, set the distance to 50 mm **1.969 in** or more.
- 3) If there is metal near the head or between the head and the charge removing object, ion is absorbed, hindering appropriate static removal. Install the head under the following installation condition.
- 4) In case using the side mounting, the discharge frequency should be 10 Hz or more.

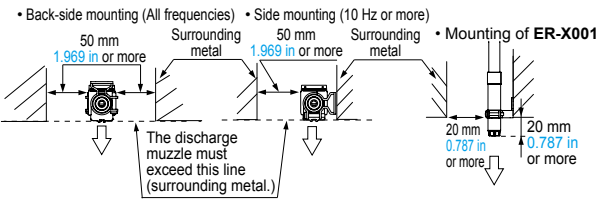

- 5) When installing two or more heads set the same frequency and keep the distance as below. In face to face or parallel using different frequency, keep the distance between the heads 400 mm **15.748 in** or more. When installing the heads face to face, install heads in distance that the heads can perform the charge removal of a side of the object individually.

• Face-to-face installation

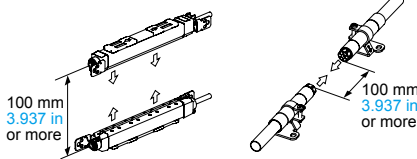

• Parallel installation

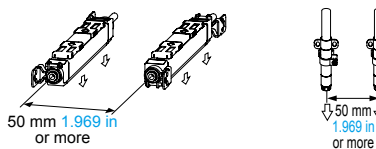

High-voltage unit installation

- Use 2 M4 screws or 2 M6 screws to fasten the head. The tightening torques for fastening, are as follows.
- When using M4 screws: 1.2 N·m
- When using M6 screws: 2.5 N·m

- Notes: 1) Do not place any objects on top of the high-voltage unit.
- 2) When using multiple heads, keep the distance of at least 10 mm **0.394 in** between the high-voltage units.
- 3) When fastening the high-voltage unit using M6 screws, fasten before connecting the head connection cable.
- 4) Use M6 screws for the installation of the high-voltage unit of the **ER-X001**.
- 5) The minimum bending radius of the high-voltage cable is 30 mm **1.181 in**.

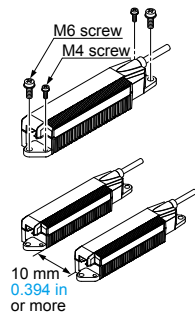

Controller installation

- Mount the controller on a 35 mm **1.378 in** wide DIN rail or using M4 screws.

<When mounting on a DIN rail>

- Pull the lock release lever to remove this product from the DIN rail.

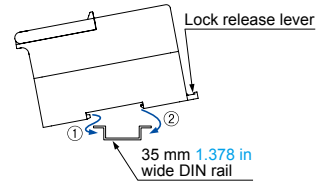

<When mounting using M4 screws>

- The tightening torque should be 1.2 N·m or less.

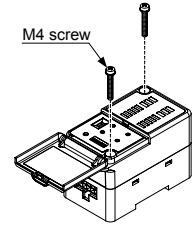

Piping

- Air supplied to this product will reduce contamination of the discharge needle and improve the charge removal speed.
- The outer diameter of the air tube to fit to the air inlet portion of this product should be $\varnothing 6$ mm **0.236 in**.
- Make sure that clean air (air containing no water, no oil and no dust) should be supplied.
- Since the pressure will drop when the air piping from the main pressure supply is extended or pneumatic components (e.g., needle valve, speed controller, mini filter) are added, keep an eye on the pressure supply to the ionizer making sure it is not in short supply. For the pneumatic components, select those that can accommodate the air supply flow rate.

ER-X008/X016/X032/X048/X064

<Connection of pipe to head section>

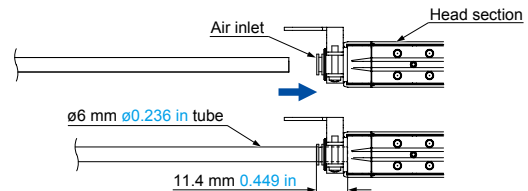

ER-X008HC/X016HC/X032HC/X048HC/X064HC

<Connection of pipe to head section>

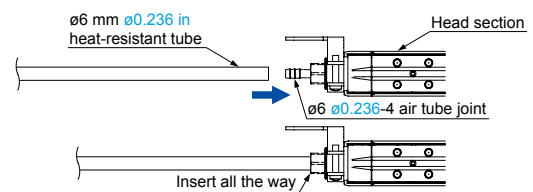

ER-X001

<Connection to high-voltage unit>

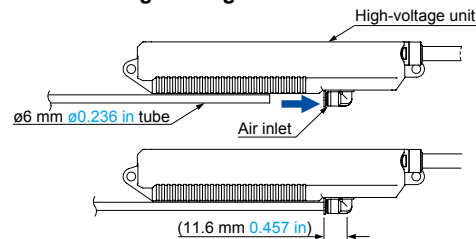

Note: After inserting the tube into the joint of this product, always make sure that the tube is all the way in and securely inserted. Insufficient tube insertion will cause air leakage.

DIMENSIONS (Unit: mm in)

The CAD data can be downloaded from our website.

ER-X008/X016/X032/X048/X064

Head

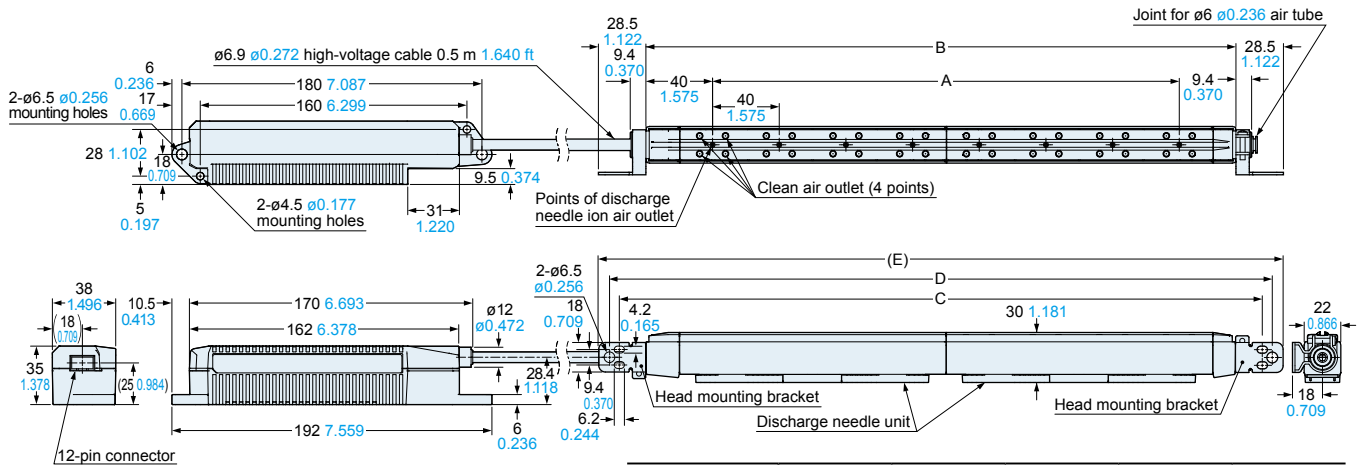

Details of a head mounting bracket

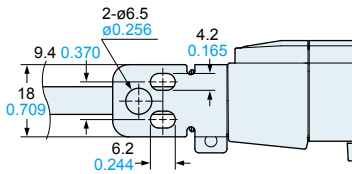

Model No.	A	B	C	D	(E)
ER-X008	40 1.575	106 4.173	138 5.433	150 5.906	163 6.417
ER-X016	120 4.724	194 7.638	226 8.898	238 9.370	251 9.882
ER-X032	280 11.024	354 13.937	386 15.197	398 15.669	411 16.181
ER-X048	440 17.323	514 20.236	546 21.496	558 21.969	571 22.480
ER-X064	600 23.622	674 26.535	706 27.795	718 28.268	731 28.780

Mounting drawing with discharge part protective cover (ER-XACVR)

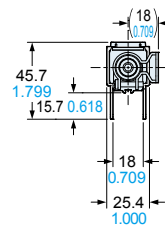
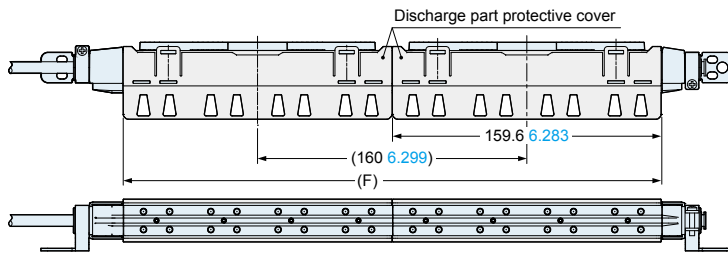

Model No.	(F)
ER-X016	159.6 6.283
ER-X032	319.6 12.583
ER-X048	479.6 18.882
ER-X064	639.6 25.181

Note: The ER-XACVR discharge part protective cover cannot be used on the ER-X008 or high and low temperature resistant type head ER-X□HC.

ER-X008HC/X016HC/X032HC/X048HC/X064HC

Head

Allowable ambient temperature: -60 to +200 °C -76 to +392 °F

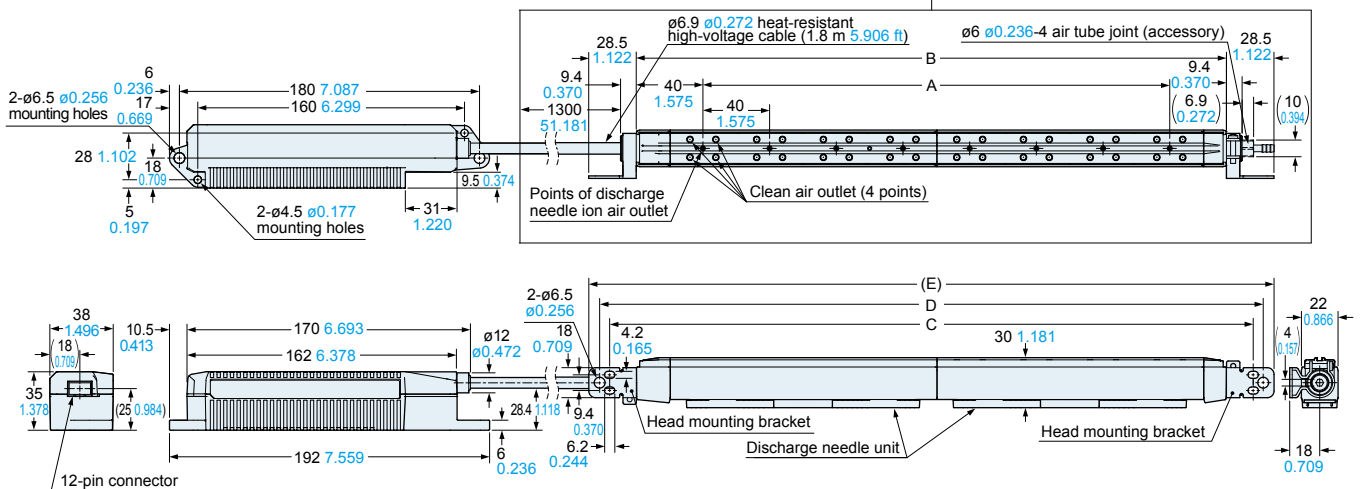

Details of a head mounting bracket

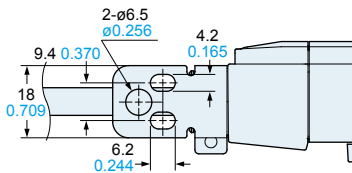

Model No.	A	B	C	D	(E)
ER-X008HC	40 1.575	106 4.173	138 5.433	150 5.906	163 6.417
ER-X016HC	120 4.724	194 7.638	226 8.898	238 9.370	251 9.882
ER-X032HC	280 11.024	354 13.937	386 15.197	398 15.669	411 16.181
ER-X048HC	440 17.323	514 20.236	546 21.496	558 21.969	571 22.480
ER-X064HC	600 23.622	674 26.535	706 27.795	718 28.268	731 28.780

ER-X001

Head

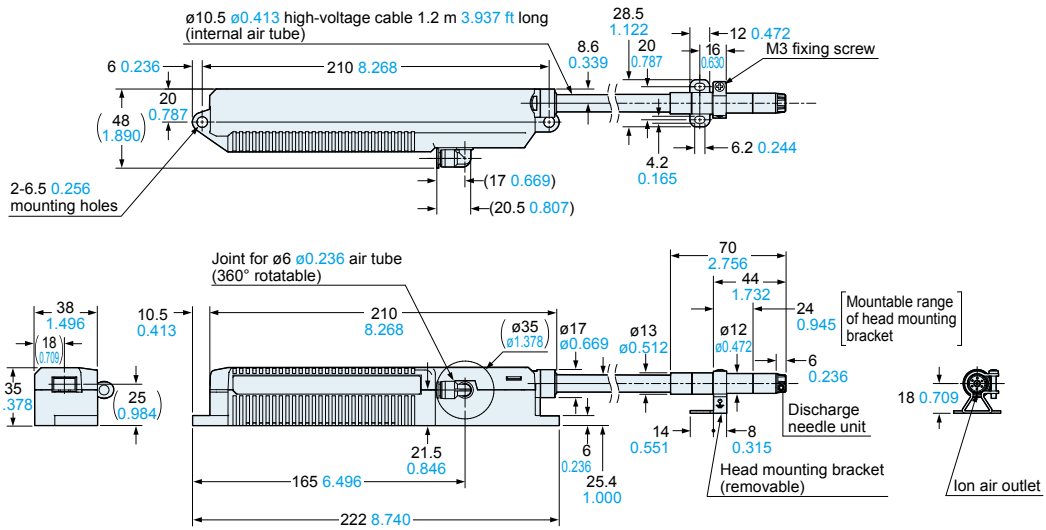

ER-XC02

Controller

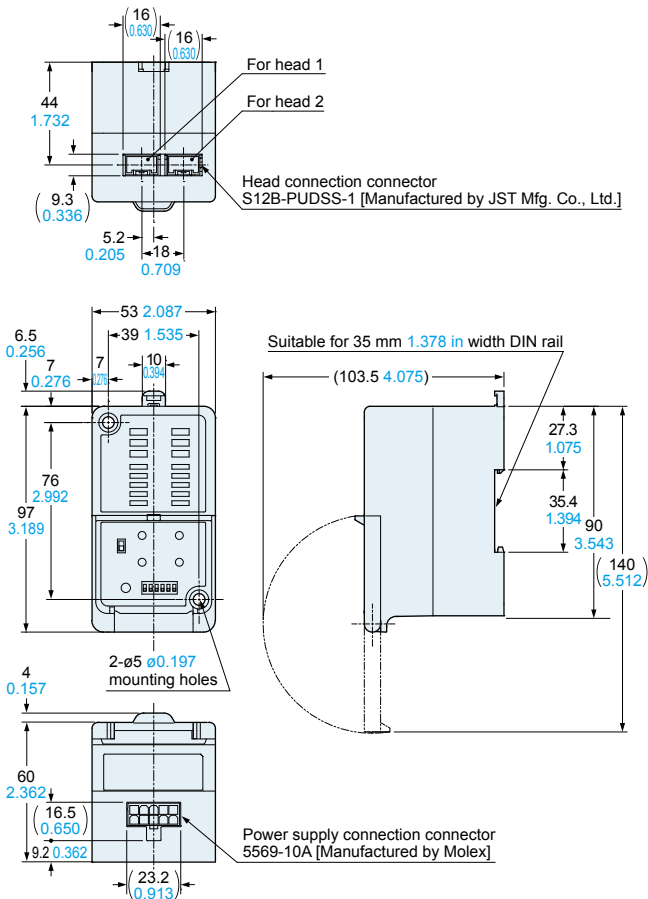

ER-XCC□H

Head connection cable

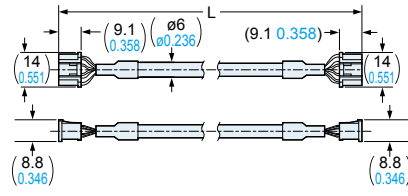

• Length L

Model No.	Length L
ER-XCCJ2H	2,000 78.740
ER-XCCJ5H	5,000 196.850
ER-XCCJ10H	10,000 393.701

ER-XCC□

Power cable (Optional)

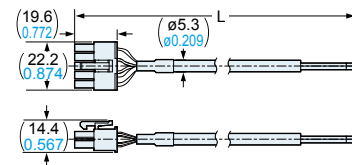

• Length L

Model No.	Length L
ER-XCC2	2,000 78.740
ER-XCC5	5,000 196.850

ER-XAPS(-EX)

AC adapter (Optional)

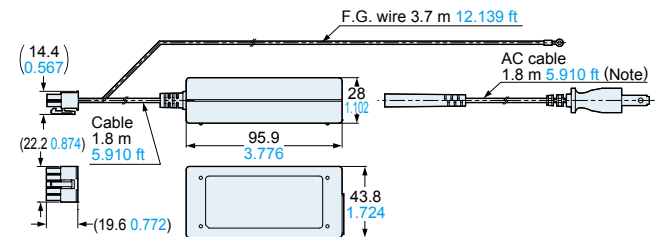

Note: The AC cable is not enclosed with ER-XAPS-EX.

Please contact:

Panasonic Industrial Devices SUNX Co., Ltd.

2431-1 Ushiyama-cho, Kasugai-shi, Aichi, 486-0901, Japan
Global Sales Department

■Telephone: +81-568-33-7861 ■Facsimile: +81-568-33-8591

panasonic.net/id/pidsx/global

