



Chipsmall Limited consists of a professional team with an average of over 10 year of expertise in the distribution of electronic components. Based in Hongkong, we have already established firm and mutual-benefit business relationships with customers from,Europe,America and south Asia,supplying obsolete and hard-to-find components to meet their specific needs.

With the principle of “Quality Parts,Customers Priority,Honest Operation,and Considerate Service”,our business mainly focus on the distribution of electronic components. Line cards we deal with include Microchip,ALPS,ROHM,Xilinx,Pulse,ON,Everlight and Freescale. Main products comprise IC,Modules,Potentiometer,IC Socket,Relay,Connector.Our parts cover such applications as commercial,industrial, and automotives areas.

We are looking forward to setting up business relationship with you and hope to provide you with the best service and solution. Let us make a better world for our industry!



Contact us

Tel: +86-755-8981 8866 Fax: +86-755-8427 6832

Email & Skype: info@chipsmall.com Web: www.chipsmall.com

Address: A1208, Overseas Decoration Building, #122 Zhenhua RD., Futian, Shenzhen, China





Fixed Resistors CONTENTS

Classification	Product Item	Part No.	Page	
Safety Precautions (Common precautions for Fixed Resistors)			2	
Surface Mount Resistors	Chip Resistors	Thick Film Chip Resistors	ERJ XG, 1G, 2G, 3G, 6G, 8G, 14, 12, 12Z, 1T	3
		Precision Thick Film Chip Resistors	ERJ XG, 1G, 1R, 2R, 3R, 6R, 3E, 6E, 8E, 14, 12, 1T	6
	High Precision	Metal Film (Thin Film) Chip Resistors, High Reliability Type	ERA 1A, 2A, 3A, 6A, 8A	10
	Current Sensing	Thick Film Chip Resistors / Low Resistance Type	ERJ 2LW, 3LW, 6LW, 2BW,3BW,6BW,8BW,6CW,8CW ERJ 2B, 3B, 6D, 6B, 8B, 14B, 3R, 6R, 8R, 14R, 12R,12Z, ERJ 1TR, L03, L06, L08, L14, L12, L1D, L1W	13
		Current Sensing Resistors, Metal Plate Type	ERJ MS4S, MS4H, MS6S, MB1S	18
		Current Sensing Resistors, Metal Plate Type	ERJ M1WS, M1WT	22
		Current Sensing Resistors, Metal Foil Type	ERJ MFBA	24
	Small&High Power	High Power Chip Resistors / Wide Terminal Type	ERJ A1, B1, B2, B3	26
		High Precision Thick Film Chip Resistors	ERJ PB3, PB6	30
		Anti-Surge Thick Film Chip Resistors	ERJ PA2, P03, PA3, P06, P08, P14	32
	Anti-Sulfurated	Anti-Pulse Thick Film Chip Resistors	ERJ T06, T08, T14	35
		Anti-Sulfurated Thick Film Chip Resistors	ERJ S02, S03, S06, S08, S14, S12, S1D, S1T ERJ U01, U02, U03, U06, U08, U14, U12, U1D, U1T ERJ U6S, U6Q	38
		Anti-Sulfurated Thick Film Chip Resistors / Anti-Surge Type	ERJ UP6, UP8	41
	Resistor Network/Array	Anti-Sulfurated High Power Chip Resistors / Wide Terminal Type	ERJ C1	44
		Chip Resistor Array	EXB 14V, 18V, 24V, 28V, N8V, 2HV, 34V, V4V, 38V, V8V, S8V	46
		Anti-Sulfurated Chip Resistor Array	EXB U14, U18, U24, U28, U2H, U34, U38	50
		Chip Resistor Networks	EXB D, E, A, Q	53
	Common specifications	Chip Attenuator	EXB 14AT, 24AT	55
		Packaging Methods (Taping)		57
		Recommended Land Pattern		62
		Recommended Soldering Conditions		64
	Power Type Resistors (Leaded)	Safety Precautions (Common precautions for Surface Mount Resistors)		65
		Metal (Oxide) Film Resistors, Flame-Retardant	ERG 12S, 1S, 1F, 2S, 2F, 3S, 3F, 5S, 5F ERX 12S, 1S, 1F, 2S, 2F, 3S, 3F, 5S, 5F	66
Anti-Pulse Power Resistors		ERG 12D, 1D, 2D, 3D	73	
Fusing Resistors	Metal Film Resistors / Low Resistance Value	ERX 12L, 1L, 2L	75	
	Metal Film Fusing Resistors	ERQ 1Z, 2Z, 12Z, 14Z ERQ 1AB, 2AB, 12A, 14A	77	
Fixed Resistors Appendix			83	

All products in this catalog comply with the RoHS Directive.

The RoHS Directive is “the Directive (2011/65/EU) on the Restriction of the Use of Certain Hazardous Substances in Electrical and Electronic Equipment “ and its revisions.

⚠ Safety Precautions (Common precautions for Fixed Resistors)

- When using our products, no matter what sort of equipment they might be used for, be sure to make a written agreement on the specifications with us in advance. The design and specifications in this catalog are subject to change without prior notice.
- Do not use the products beyond the specifications described in this catalog.
- This catalog explains the quality and performance of the products as individual components. Before use, check and evaluate their operations when installed in your products.
- Install the following systems for a failsafe design to ensure safety if these products are to be used in equipment where a defect in these products may cause the loss of human life or other significant damage, such as damage to vehicles (automobile, train, vessel), traffic lights, medical equipment, aerospace equipment, electric heating appliances, combustion/gas equipment, rotating equipment, and disaster/crime prevention equipment.
- * Systems equipped with a protection circuit and a protection device
- * Systems equipped with a redundant circuit or other system to prevent an unsafe status in the event of a single fault

(1) Precautions for use

- These products are designed and manufactured for general and standard use in general electronic equipment (e.g. AV equipment, home electric appliances, office equipment, information and communication equipment)
- These products are not intended for use in the following special conditions. Before using the products, carefully check the effects on their quality and performance, and determine whether or not they can be used.
 1. In liquid, such as water, oil, chemicals, or organic solvent
 2. In direct sunlight, outdoors, or in dust
 3. In salty air or air with a high concentration of corrosive gas, such as Cl₂, H₂S, NH₃, SO₂, or NO₂
 4. Electric Static Discharge (ESD) Environment
These components are sensitive to static electricity and can be damaged under static shock (ESD). Please take measures to avoid any of these environments.
Smaller components are more sensitive to ESD environment.
 5. Electromagnetic Environment
Avoid any environment where strong electromagnetic waves exist.
 6. In an environment where these products cause dew condensation
 7. Sealing or coating of these products or a printed circuit board on which these products are mounted, with resin or other materials
- These products generate Joule heat when energized. Carefully position these products so that their heat will not affect the other components.
- Carefully position these products so that their temperatures will not exceed the category temperature range due to the effects of neighboring heat-generating components. Do not mount or place heat-generating components or inflammables, such as vinyl-coated wires, near these products.
- Note that non-cleaning solder, halogen-based highly active flux, or water-soluble flux may deteriorate the performance or reliability of the products.
- Carefully select a flux cleaning agent for use after soldering. An unsuitable agent may deteriorate the performance or reliability. In particular, when using water or a water-soluble cleaning agent, be careful not to leave water residues. Otherwise, the insulation performance may be deteriorated.

(2) Precautions for storage

The performance of these products, including the solderability, is guaranteed for a year from the date of arrival at your company, provided that they remain packed as they were when delivered and stored at a temperature of 5 °C to 35 °C and a relative humidity of 45 % to 85 %.

Even within the above guarantee periods, do not store these products in the following conditions. Otherwise, their electrical performance and/or solderability may be deteriorated, and the packaging materials (e.g. taping materials) may be deformed or deteriorated, resulting in mounting failures.

1. In salty air or in air with a high concentration of corrosive gas, such as Cl₂, H₂S, NH₃, SO₂, or NO₂
2. In direct sunlight

<Package markings>

Package markings include the product number, quantity, and country of origin. In principle, the country of origin should be indicated in English.

Thick Film Chip Resistors

Type: **ERJ XG, 1G, 2G, 3G, 6G, 8G, 14, 12, 12Z, 1T**



Features

- Small size and lightweight
- High reliability
Metal glaze thick film resistive element and three layers of electrodes
- Compatible with placement machines
Taping packaging available
- Suitable for both reflow and flow soldering
- Reference Standards
IEC 60115-8, JIS C 5201-8, EIAJ RC-2134B
- AEC-Q200 qualified (Exemption ERJXG)
- RoHS compliant

As for Packaging Methods, Land Pattern, Soldering Conditions and Safety Precautions,
Please see Data Files

Explanation of Part Numbers

- ERJXGN, 1GN, 2GE, 3GE, 6GE, 8GE, 14, 12, 12Z, 1T Type, $\pm 5\%$

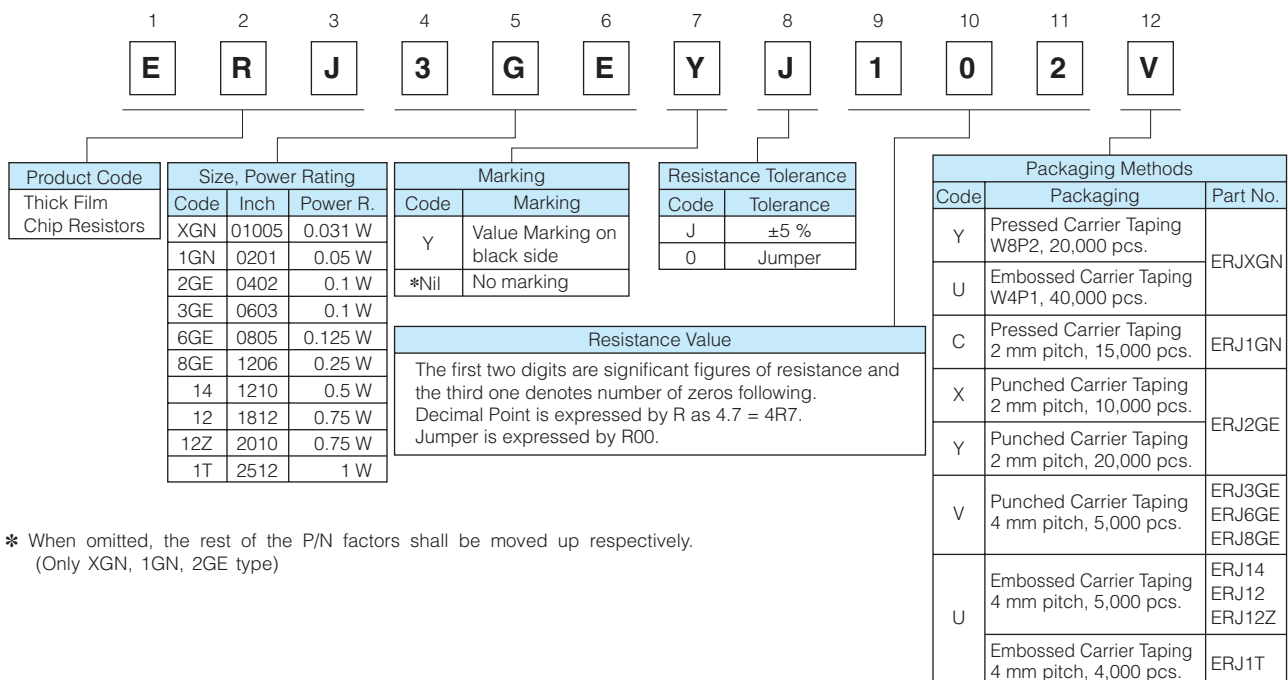

* When omitted, the rest of the P/N factors shall be moved up respectively.
(Only XGN, 1GN, 2GE type)

Construction

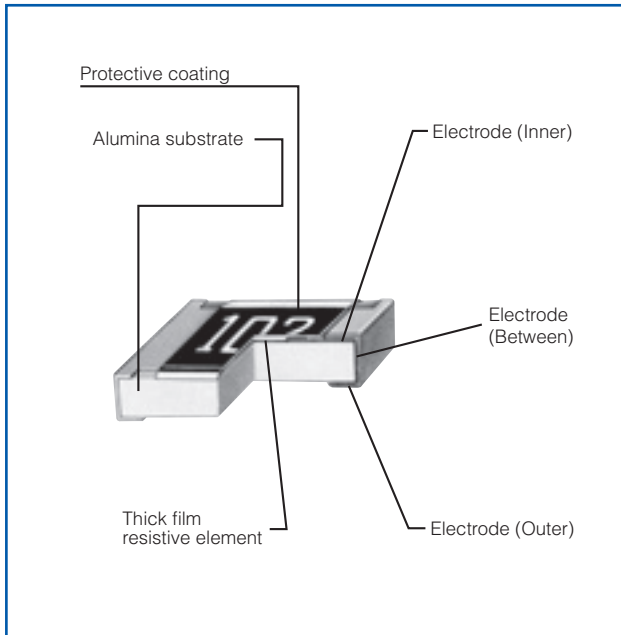

Dimensions in mm (not to scale)

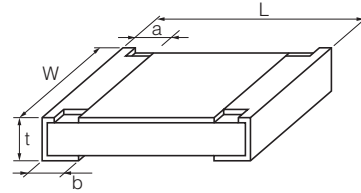

Part No.	Dimensions (mm)					Mass (Weight) (g/1000 pcs.)
	L	W	a	b	t	
ERJXG	0.40 ^{±0.02}	0.20 ^{±0.02}	0.10 ^{±0.03}	0.10 ^{±0.03}	0.13 ^{±0.02}	0.04
ERJ1G	0.60 ^{±0.03}	0.30 ^{±0.03}	0.10 ^{±0.05}	0.15 ^{±0.05}	0.23 ^{±0.03}	0.15
ERJ2G	1.00 ^{±0.05}	0.50 ^{±0.05}	0.20 ^{±0.10}	0.25 ^{±0.05}	0.35 ^{±0.05}	0.8
ERJ3G	1.60 ^{±0.15}	0.80 ^{+0.15/-0.05}	0.30 ^{±0.20}	0.30 ^{±0.15}	0.45 ^{±0.10}	2
ERJ6G	2.00 ^{±0.20}	1.25 ^{±0.10}	0.40 ^{±0.20}	0.40 ^{±0.20}	0.60 ^{±0.10}	4
ERJ8G	3.20 ^{+0.05/-0.20}	1.60 ^{+0.05/-0.15}	0.50 ^{±0.20}	0.50 ^{±0.20}	0.60 ^{±0.10}	10
ERJ14	3.20 ^{±0.20}	2.50 ^{±0.20}	0.50 ^{±0.20}	0.50 ^{±0.20}	0.60 ^{±0.10}	16
ERJ12	4.50 ^{±0.20}	3.20 ^{±0.20}	0.50 ^{±0.20}	0.50 ^{±0.20}	0.60 ^{±0.10}	27
ERJ12Z	5.00 ^{±0.20}	2.50 ^{±0.20}	0.60 ^{±0.20}	0.60 ^{±0.20}	0.60 ^{±0.10}	27
ERJ1T	6.40 ^{±0.20}	3.20 ^{±0.20}	0.65 ^{±0.20}	0.60 ^{±0.20}	0.60 ^{±0.10}	45

Ratings

[For Resistor]

Part No. (inch size)	Power Rating ⁽³⁾ at 70 °C (W)	Limiting Element Voltage ⁽¹⁾ (V)	Maximum Overload Voltage ⁽²⁾ (V)	Resistance Tolerance (%)	Resistance Range (Ω)	T.C.R. (× 10 ⁻⁶ /°C)	Category Temperature Range (°C)	AEC-Q200 Grade
ERJXG (01005)	0.031	15	30	±5	4.7 to 1M (E24)	<10 Ω : -100 to +600 10 Ω to 100 Ω : ±300 100 Ω < : ±200	-55 to +125	-
ERJ1G (0201)	0.05	25	50	±5	1 to 10M (E24)	<10 Ω : -100 to +600 10 Ω to 1M Ω : ±200 1M Ω < : -400 to +150	-55 to +125	Grade 1
ERJ2G (0402)	0.1	50	100	±5	1 to 10M (E24)		-55 to +155	Grade 0
ERJ3G (0603)	0.1	75	150	±5	1 to 10M (E24)		-55 to +155	Grade 0
ERJ6G (0805)	0.125	150	200	±5	1 to 10M (E24)		-55 to +155	Grade 0
ERJ8G (1206)	0.25	200	400	±5	1 to 10M (E24)		-55 to +155	Grade 0
ERJ14 (1210)	0.5	200	400	±5	1 to 10M (E24)		-55 to +155	Grade 0
ERJ12 (1812)	0.75	200	500	±5	1 to 10M (E24)		-55 to +155	Grade 0
ERJ12Z (2010)	0.75	200	500	±5	1 to 10M (E24)		-55 to +155	Grade 0
ERJ1T (2512)	1	200	500	±5	1 to 1M (E24)		-55 to +155	Grade 0

- (1) Rated Continuous Working Voltage (RCWW) shall be determined from RCWW=√Power Rating × Resistance Values, or Limiting Element Voltage listed above, whichever less.
 (2) Overload Test Voltage (OTV) shall be determined from OTV=Specified Magnification (refer to performance) × RCWW or Maximum Overload Voltage listed above, whichever less.
 (3) Use it on the condition that the case temperature is below the upper category temperature.

[For Jumper]

Part No. (inch size)	Rated Current (A)	Maximum Overload Current ⁽¹⁾ (A)
ERJXG (01005)	0.5	1
ERJ1G (0201)		
ERJ2G (0402)		
ERJ3G (0603)	1	2
ERJ6G (0805)		
ERJ8G (1206)		
ERJ14 (1210)	2	4
ERJ12 (1812)		
ERJ12Z (2010)		
ERJ1T (2512)		

(1) Overload test current

Power Derating Curve

For resistors operated in ambient temperatures above 70 °C, power rating shall be derated in accordance with the figure below.

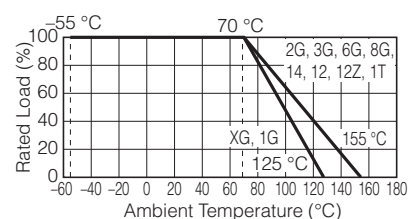

Performance

Test Item	Performance Requirements		Test Conditions
	Resistor type	Jumper type	
Resistance	Within Specified Tolerance	50m Ω or less	20 °C
T. C. R.	Within Specified T. C. R.	50m Ω or less	+25 °C/+155 °C (ERJXG, ERJ1G : +25 °C/+125 °C)
Overload	±2%	50m Ω or less	Rated Voltage × 2.5, 5 s Jumper type : Max. Overload Current, 5 s
Resistance to Soldering Heat	±1%	50m Ω or less	270 °C, 10 s
Rapid Change of Temperature	±1%	50m Ω or less	-55 °C (30min.) / +155 °C (ERJXG, ERJ1G : +125 °C) (30min.), 100 cycles
High Temperature Exposure	±1%	50m Ω or less	+155 °C (ERJXG, ERJ1G : +125 °C) , 1000 h
Damp Heat, Steady State	±1%	50m Ω or less	60 °C, 90% to 95 %RH, 1000 h
Load Life in Humidity	±3%	50m Ω or less	60 °C, 90% to 95 %RH, Rated Voltage (Jumper type: Rated Current), 1.5 h ON/0.5 h OFF cycle, 1000 h
Endurance at 70 °C	±3%	50m Ω or less	70 °C, Rated Voltage(Jumper type: Rated Current), 1.5 h ON/0.5 h OFF cycle, 1000 h

Precision Thick Film Chip Resistors

Type: **ERJ XG, 1G**
ERJ 1R, 2R, 3R, 6R
ERJ 3E, 6E, 8E, 14, 12, 1T

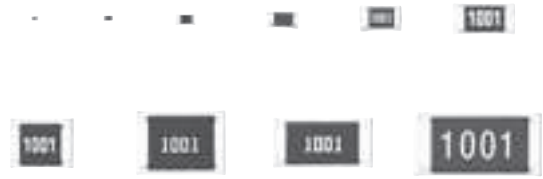

Features

- Small size and lightweight
- High reliability
Metal glaze thick film resistive element and three layers of electrodes
- Compatible with placement machines
Taping packaging available
- Suitable for both reflow and flow soldering
- Low Resistance Tolerance
ERJXG, 1G, 2R, 3E, 6E, 8E, 14, 12, 1T Type : ±1 %
ERJ1R, 2R, 3R, 6R Type : ±0.5 %
- Reference Standards
IEC 60115-8, JIS C 5201-8, EIAJ RC-2134B
- AEC-Q200 qualified (Exemption ERJXG, ERJ1R)
- RoHS compliant

■ **As for Packaging Methods, Land Pattern, Soldering Conditions and Safety Precautions,**
 Please see Data Files

Explanation of Part Numbers

- ERJ1R, 2R, 3R, 6R Type, ±0.5 %

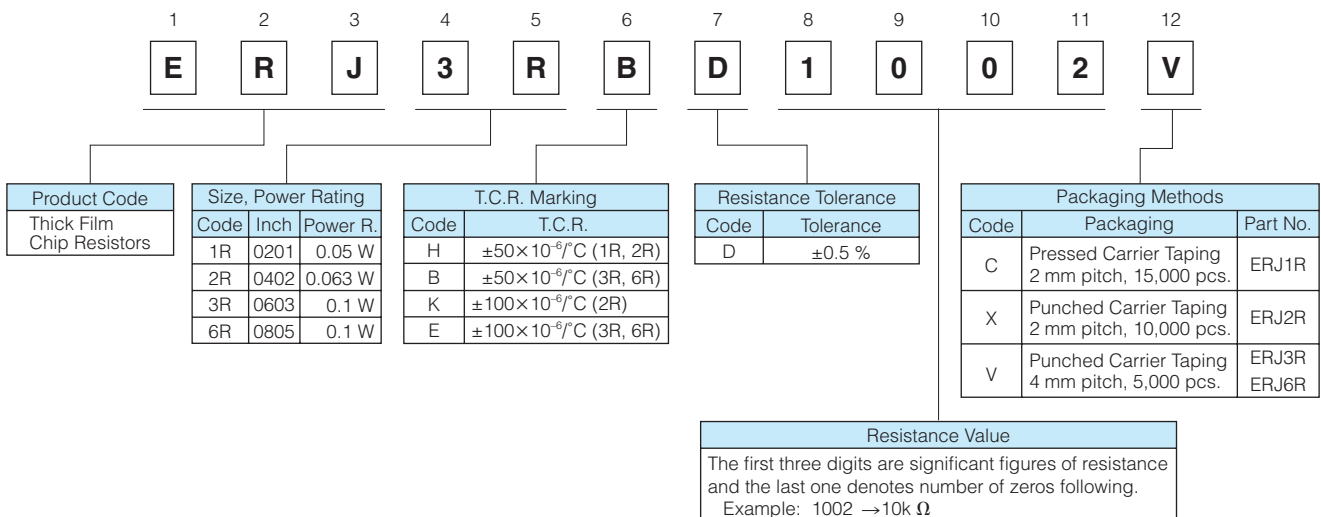

- ERJXGN, 1GN, 2RC, 2RK, 3EK, 6EN, 8EN, 14N, 12N, 12S, 1TN Type, ±1%

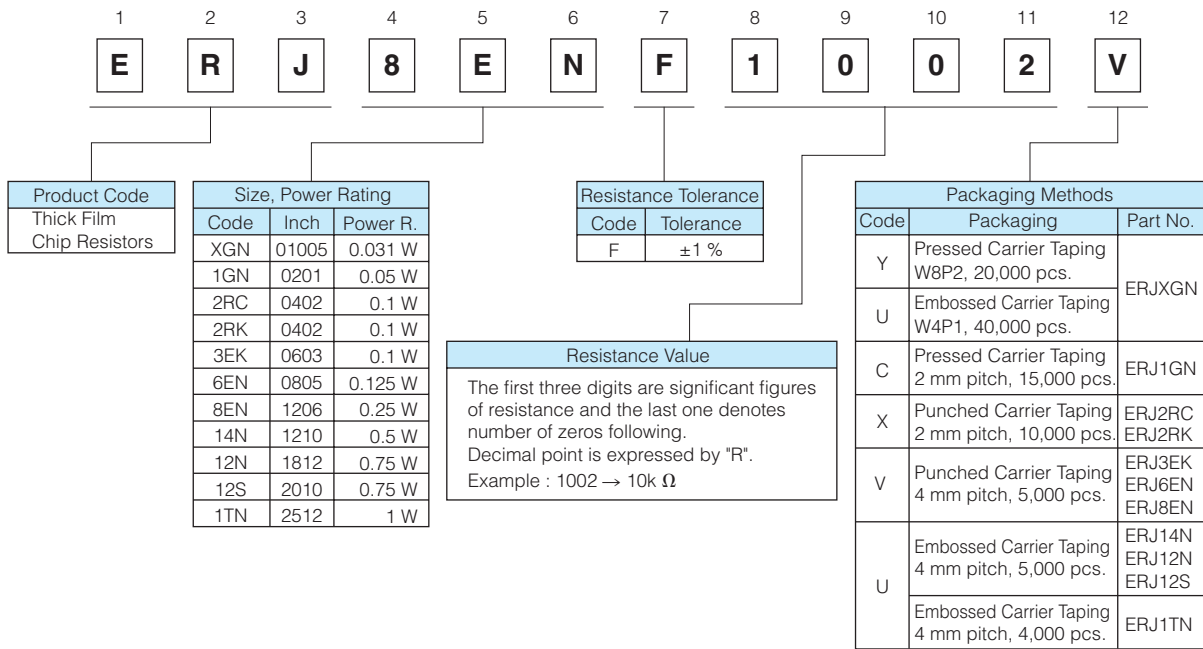

Construction

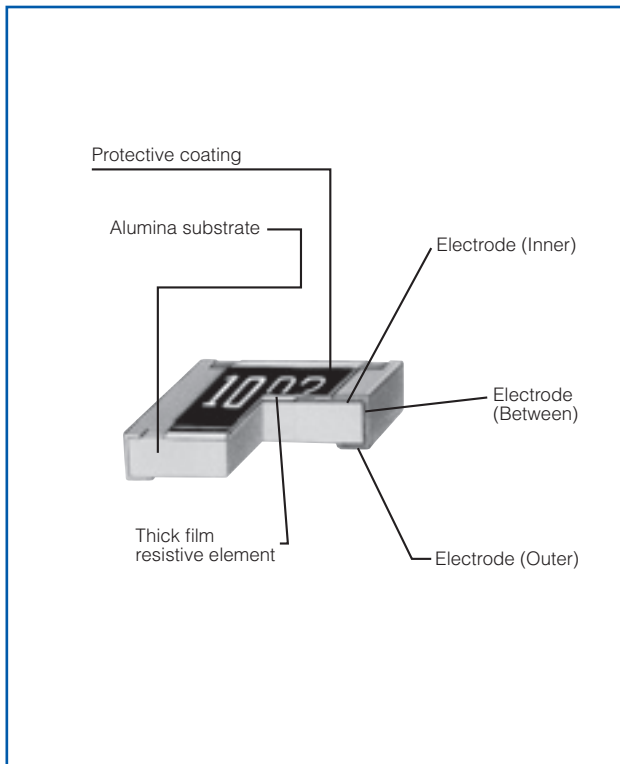

Dimensions in mm (not to scale)

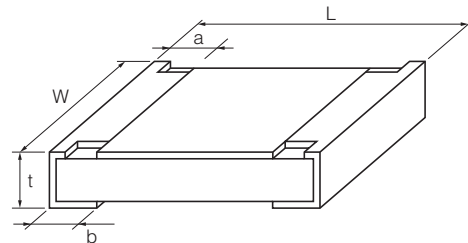

Part No.	Dimensions (mm)					Mass (Weight) [g/1000 pcs.]
	L	W	a	b	t	
ERJXG	0.40 ^{+0.02}	0.20 ^{+0.02}	0.10 ^{+0.03}	0.10 ^{+0.03}	0.13 ^{+0.02}	0.04
ERJ1G, 1R	0.60 ^{+0.03}	0.30 ^{+0.03}	0.10 ^{+0.05}	0.15 ^{+0.05}	0.23 ^{+0.03}	0.15
ERJ2R□	1.00 ^{+0.05}	0.50 ^{+0.05}	0.20 ^{+0.10}	0.25 ^{+0.05}	0.35 ^{+0.05}	0.8
ERJ3R□ ERJ3EK	1.60 ^{+0.15}	0.80 ^{+0.15}	0.30 ^{+0.20}	0.30 ^{+0.15}	0.45 ^{+0.10}	2
ERJ6R□ ERJ6EN	2.00 ^{+0.20}	1.25 ^{+0.10}	0.40 ^{+0.20}	0.40 ^{+0.20}	0.60 ^{+0.10}	4
ERJ8EN	3.20 ^{+0.05} _{-0.20}	1.60 ^{+0.05} _{-0.15}	0.50 ^{+0.20}	0.50 ^{+0.20}	0.60 ^{+0.10}	10
ERJ14N	3.20 ^{+0.20}	2.50 ^{+0.20}	0.50 ^{+0.20}	0.50 ^{+0.20}	0.60 ^{+0.10}	16
ERJ12N	4.50 ^{+0.20}	3.20 ^{+0.20}	0.50 ^{+0.20}	0.50 ^{+0.20}	0.60 ^{+0.10}	27
ERJ12S	5.00 ^{+0.20}	2.50 ^{+0.20}	0.60 ^{+0.20}	0.60 ^{+0.20}	0.60 ^{+0.10}	27
ERJ1TN	6.40 ^{+0.20}	3.20 ^{+0.20}	0.65 ^{+0.20}	0.60 ^{+0.20}	0.60 ^{+0.10}	45

Ratings

<±0.5 %>

Part No. (inch size)	Power Rating at 70 °C ⁽⁴⁾ (W)	Limiting Element Voltage ⁽¹⁾ (V)	Maximum Overload Voltage ⁽²⁾ (V)	Resistance Tolerance (%)	Resistance Range (Ω)	T.C.R. (×10 ⁻⁶ /°C)	Category Temperature Range (°C)	AEC-Q200 Grade
ERJ1RH (0201)	0.05	15	30	±0.5	1k to 1M (E24, E96)	±50	-55 to +125	-
ERJ2RH (0402)	0.063	50	100	±0.5	100 to 100k (E24, E96)	±50	-55 to +155	Grade 0
ERJ2RK (0402)	0.063	50	100	±0.5	10 to 97.6 102k to 1M (E24, E96)	±100	-55 to +155	Grade 0
ERJ3RB (0603)	0.1	50	100	±0.5	100 to 100k (E24, E96)	±50	-55 to +155	Grade 0
ERJ3RE (0603)	0.1	50	100	±0.5	10 to 97.6 102k to 1M (E24, E96)	±100	-55 to +155	Grade 0
ERJ6RB (0805)	0.1	150	200	±0.5	100 to 100k (E24, E96)	±50	-55 to +155	Grade 0
ERJ6RE (0805)	0.1	150	200	±0.5	10 to 97.6 102k to 1M (E24, E96)	±100	-55 to +155	Grade 0

<±1 %>

Part No. (inch size)	Power Rating at 70 °C ⁽⁴⁾ (W)	Limiting Element Voltage ⁽¹⁾ (V)	Maximum Overload Voltage ⁽²⁾ (V)	Resistance Tolerance (%)	Resistance Range (Ω)	T.C.R. (×10 ⁻⁶ /°C)	Category Temperature Range (°C)	AEC-Q200 Grade
ERJXGN (01005)	0.031	15	30	±1	10 to 1 M (E24, E96)	<100 Ω : ±300 100 Ω ≤ : ±200	-55 to +125	-
ERJ1GN (0201)	0.05	25	50	±1	10 to 1 M ⁽³⁾ (E24, E96)	±200	-55 to +125	Grade 1
ERJ2RC (0402)	0.1	50	100	±1	1 to 9.76 (E24, E96)	-100 to +600	-55 to +155	Grade 0
ERJ2RK (0402)	0.1	50	100	±1	10 to 1 M (E24, E96)	±100	-55 to +155	Grade 0
ERJ3EK (0603)	0.1	75	150	±1	10 to 1 M (E24, E96)	±100	-55 to +155	Grade 0
ERJ6EN (0805)	0.125	150	200	±1	10 to 2.2 M (E24, E96)	±100	-55 to +155	Grade 0
ERJ8EN (1206)	0.25	200	400	±1	10 to 2.2 M (E24, E96)	±100	-55 to +155	Grade 0
ERJ14N (1210)	0.5	200	400	±1	10 to 1 M (E24, E96)	±100	-55 to +155	Grade 0
ERJ12N (1812)	0.75	200	500	±1	10 to 1 M (E24, E96)	±100	-55 to +155	Grade 0
ERJ12S (2010)	0.75	200	500	±1	10 to 1 M (E24, E96)	±100	-55 to +155	Grade 0
ERJ1TN (2512)	1	200	500	±1	10 to 1 M (E24, E96)	±100	-55 to +155	Grade 0

(1) Rated Continuous Working Voltage (RCWV) shall be determined from $RCWV = \sqrt{\text{Power Rating} \times \text{Resistance Values}}$, or Limiting Element Voltage listed above, whichever less.
 (2) Overload Test Voltage (OTV) shall be determined from $OTV = \text{Specified Magnification (refer to performance)} \times RCWV$ or Maximum Overload Voltage listed above, whichever less.
 (3) Please contact us when you need a type with a resistance of less than 10 Ω.
 (4) Use it on the condition that the case temperature is below the upper category temperature.

Power Derating Curve

For resistors operated in ambient temperatures above 70 °C, power rating shall be derated in accordance with the figure on the right.

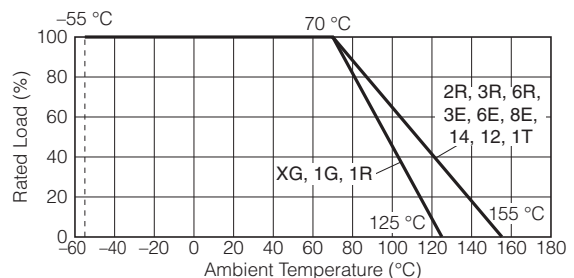

Performance

● ERJ1R, 2R, 3R, 6R Type, $\pm 0.5\%$ (D)

Test Item	Performance Requirements	Test Conditions
Resistance	Within Specified Tolerance	20 °C
T. C. R.	Within Specified T. C. R.	+25 °C/+125 °C
Overload	$\pm 2\%$	Rated Voltage \times 2.5, 5 s
Resistance to Soldering Heat	$\pm 1\%$	270 °C, 10 s
Rapid Change of Temperature	$\pm 1\%$	-55 °C (30min.) / +155 °C (ERJ1R : +125 °C) (30min.), 100 cycles
High Temperature Exposure	$\pm 1\%$	+155 °C (ERJ1R : +125 °C) , 1000 h
Damp Heat, Steady State	$\pm 1\%$	60 °C, 90% to 95 %RH, 1000 h
Load Life in Humidity	$\pm 2\%$ ERJ1R: $\pm 3\%$	60 °C, 90% to 95 %RH, Rated Voltage, 1.5 h ON/0.5 h OFF cycle, 1000 h
Endurance at 70 °C	$\pm 2\%$ ERJ1R: $\pm 3\%$	70 °C, Rated Voltage, 1.5 h ON/0.5 h OFF cycle, 1000 h

● ERJXGN, 1GN, 2RC, 2RK, 3EK, 6EN, 8EN, 14N, 12N, 12S, 1TN Type, $\pm 1\%$ (F)

Test Item	Performance Requirements	Test Conditions
Resistance	Within Specified Tolerance	20 °C
T. C. R.	Within Specified T. C. R.	+25 °C/+155 °C (ERJXG, ERJ1G : +25 °C/+125 °C)
Overload	$\pm 2\%$	Rated Voltage \times 2.5, 5 s
Resistance to Soldering Heat	$\pm 1\%$	270 °C, 10 s
Rapid Change of Temperature	$\pm 1\%$	-55 °C (30min.) / +155 °C (ERJXG, ERJ1G : +125 °C) (30min.), 100 cycles
High Temperature Exposure	$\pm 1\%$	+155 °C (ERJXG, ERJ1G : +125 °C) , 1000 h
Damp Heat, Steady State	$\pm 1\%$	60 °C, 90% to 95 %RH, 1000 h
Load Life in Humidity	$\pm 2\%$ ERJXG, ERJ1G: $\pm 3\%$	60 °C, 90% to 95 %RH, Rated Voltage, 1.5 h ON/0.5 h OFF cycle, 1000 h
Endurance at 70 °C	$\pm 2\%$ ERJXG, ERJ1G: $\pm 3\%$	70 °C, Rated Voltage, 1.5 h ON/0.5 h OFF cycle, 1000 h

Metal Film (Thin Film) Chip Resistors, High Reliability Type

Type: **ERA 1A, 2A, 3A, 6A, 8A**

Features

- High reliability Stable at high temperature and humidity
(85 °C 85 %RH rated load, Category temperature range : -55 °C to +155 °C)
- High accuracy Small resistance tolerance and Temperature Coefficient of Resistance
- High performance Low current noise, excellent linearity
- Reference Standard IEC 60115-8, JIS C 5201-8, EIAJ RC-2133B
- AEC-Q200 qualified
- RoHS compliant

As for Packaging Methods, Land Pattern, Soldering Conditions and Safety Precautions,
Please see Data Files

Explanation of Part Numbers

- E24 Series

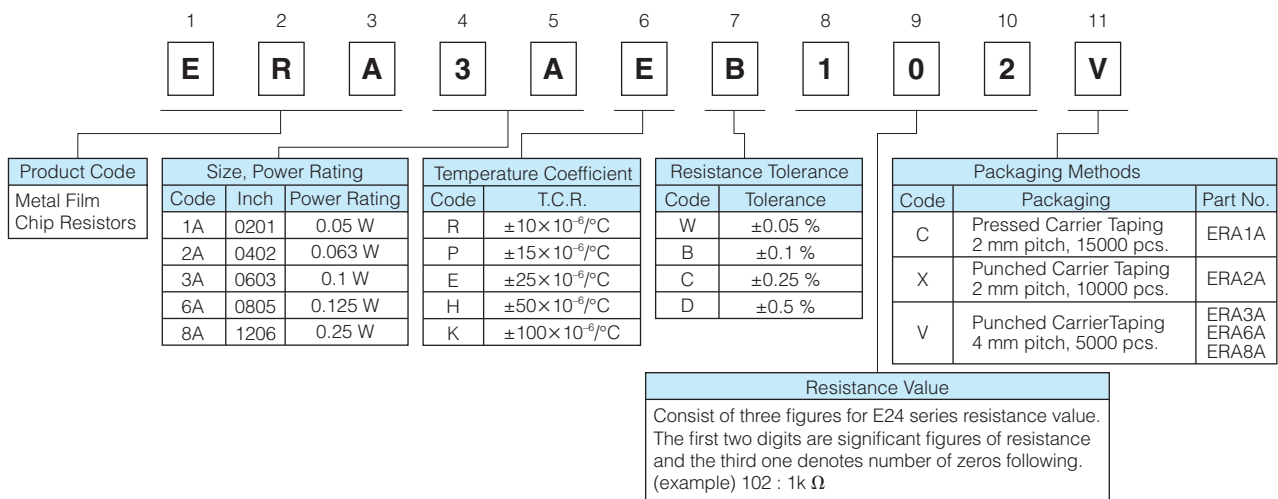

- E96 Series and other Resistance values

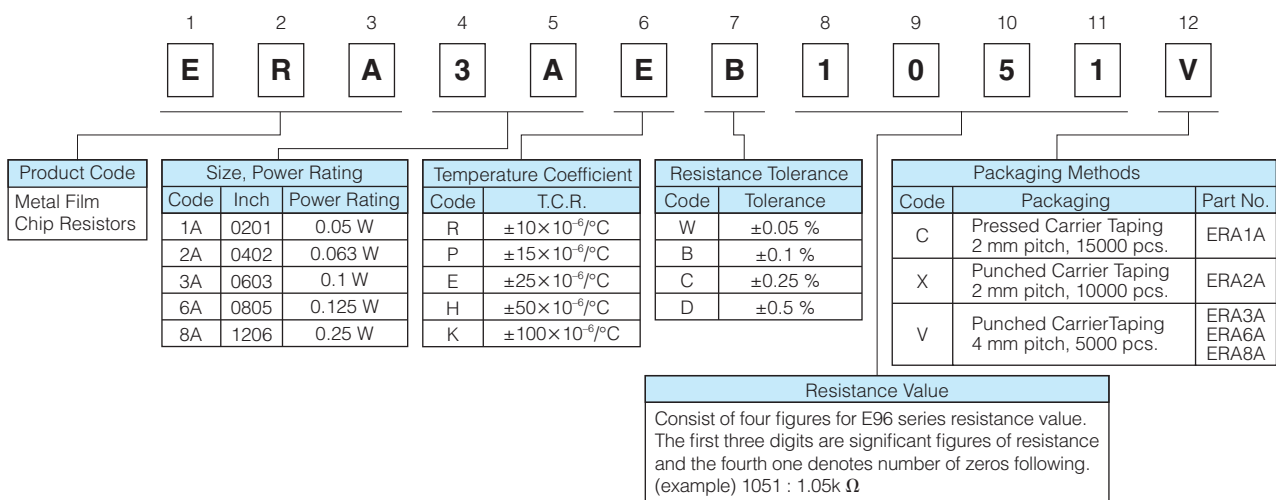

note : Duplicated resistance values as E24 series part numbers shall follow E24 part numbers.
(apply three digit resistance value)

Construction

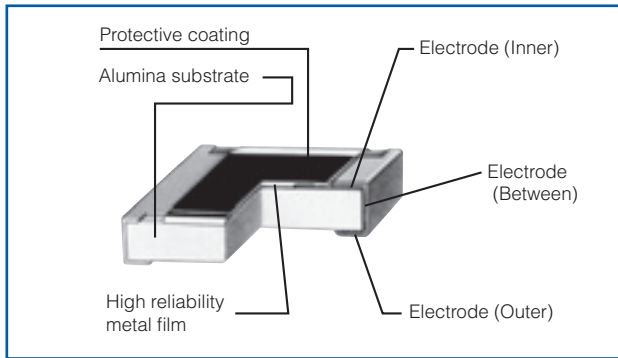

Dimensions in mm (not to scale)

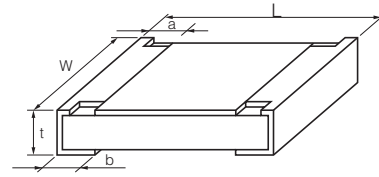

Part No. (inch size)	Dimensions (mm)					Mass (Weight) [g/1000pcs.]
	L	W	a	b	t	
ERA1A (0201)	0.60 ^{±0.03}	0.30 ^{±0.03}	0.15 ^{±0.05}	0.15 ^{±0.05}	0.23 ^{±0.03}	0.14
ERA2A (0402)	1.00 ^{±0.10}	0.50 ^{±0.05}	0.15 ^{±0.10}	0.25 ^{±0.10}	0.35 ^{±0.05}	0.6
ERA3A (0603)	1.60 ^{±0.20}	0.80 ^{±0.20}	0.30 ^{±0.20}	0.30 ^{±0.20}	0.45 ^{±0.10}	2
ERA6A (0805)	2.00 ^{±0.20}	1.25 ^{±0.10}	0.40 ^{±0.25}	0.40 ^{±0.25}	0.50 ^{±0.10}	4
ERA8A (1206)	3.20 ^{±0.20}	1.60 ^{±0.15}	0.50 ^{±0.25}	0.50 ^{±0.25}	0.60 ^{±0.10}	8

Ratings

Part No. (inch size)	Power Rating at 85 °C (W)	Limiting Element Voltage ⁽¹⁾ (V)	Maximum Overload Voltage ⁽²⁾ (V)	Part No. (detail)	Resistance Tolerance (%)	T.C.R. (×10 ⁻⁶ /°C)	Resistance Range ⁽³⁾⁽⁴⁾ (Ω)	Category Temperature Range (°C)
ERA1A (0201)	0.05	25	50	ERA1AEB	±0.1	±25	100 to 10k (E24, E96)	-55 to +155
				ERA1AEC	±0.25			
				ERA1ARC	±0.25			
				ERA1ARB	±0.1	±10	100 to 10k (E24, E96)	
				ERA1ARW	±0.05			
ERA2A (0402)	0.063	50	100	ERA2AKD	±0.5	±100	10 to 46.4 (E24, E96)	
				ERA2AED	±0.5			
				ERA2AEC	±0.25	±25	47 to 100k (E24, E96)	
				ERA2AEB	±0.1			
				ERA2APC	±0.25			
				ERA2APB	±0.1	±15	200 to 47k (E24, E96)	
				ERA2ARC	±0.25			
ERA2ARB	±0.1	±10	200 to 47k (E24, E96)					
ERA3A (0603)	0.1	75	150	ERA3AHD	±0.5	±50	10 to 46.4 (E24, E96)	
				ERA3AED	±0.5			
				ERA3AEC	±0.25	±25	47 to 330k (E24, E96)	
				ERA3AEB	±0.1			
				ERA3APC	±0.25			
				ERA3APB	±0.1	±15	470 to 100k (E24, E96)	
				ERA3ARC	±0.25			
				ERA3ARB	±0.1	±10	1k to 100k (E24, E96)	
ERA3ARW	±0.05							
ERA6A (0805)	0.125	100	200	ERA6AHD	±0.5	±50	10 to 46.4 (E24, E96)	
				ERA6AED	±0.5			
				ERA6AEC	±0.25	±25	47 to 1M (E24, E96)	
				ERA6AEB	±0.1			
				ERA6APC	±0.25			
				ERA6APB	±0.1	±15	470 to 100k (E24, E96)	
				ERA6ARC	±0.25			
ERA6ARB	±0.1	±10	1k to 100k (E24, E96)					
ERA6ARW	±0.05							
ERA8A (1206)	0.25	150	300	ERA8AHD	±0.5	±50	10 to 46.4 (E24, E96)	
				ERA8AED	±0.5			
				ERA8AEC	±0.25	±25	47 to 1M (E24, E96)	
				ERA8AEB	±0.1			
				ERA8APC	±0.25			
				ERA8APB	±0.1	±15	470 to 100k (E24, E96)	
				ERA8ARC	±0.25			
				ERA8ARB	±0.1	±10	1k to 100k (E24, E96)	
ERA8ARW	±0.05							

(1) Rated Continuous Working Voltage (RCWV) shall be determined from $RCWV = \sqrt{\text{Rated Power} \times \text{Resistance Values}}$, or Limiting Element Voltage listed above, whichever less.
 (2) Overload (Short-time Overload) Test Voltage (SOTV) shall be determined from $SOTV = 2.5 \times RCWV$ or max. Overload Voltage listed above whichever less.
 (3) E192 series resistance values are also available. Please contact us for details.
 (4) Duplicated resistance values between E96, E192 and E24 series shall follow E24 Part Numbers. (apply three digit resistance value)

Power Derating Curve

For resistors operated in ambient temperatures above 85 °C, power rating shall be derated in accordance with the figure on the right.

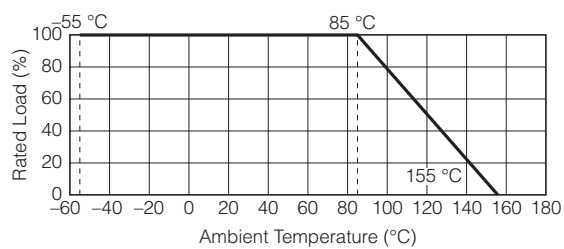

Thick Film Chip Resistors / Low Resistance Type

Type: **ERJ 2LW, 3LW, 6LW**
2BW, 3BW, 6BW,
8BW, 6CW, 8CW
ERJ 2B, 3B, 6D, 6B, 8B,
14B, 3R, 6R, 8R, 14R,
12R, 12Z, 1TR
ERJ L03, L06, L08, L14,
L12, L1D, L1W



Features

- Current Sensing resistor
- Small size and lightweight
- Realize both low-resistance & High-precision by original thick film resistive element & special electrode structure
- Suitable for both reflow and flow soldering
- Realize High-power by double-sided resistive elements structure that aimed to suppress temperature rising : ERJ2LW, 3LW, 6LW, 2BW, 3BW, 6BW, 8BW, 6CW, 8CW
- Low TCR : $\pm 75 \times 10^{-6} / ^\circ\text{C}$ (ERJ6CW, 8CW)
- Low Resistance Value : Thick film resistors available from 5m Ω (ERJ3LW, 6LW)
- Reference Standards : IEC 60115-8, JIS C 5201-8, JEITA RC-2144
- AEC-Q200 qualified
- RoHS compliant

■ **As for Packaging Methods, Land Pattern, Soldering Conditions and Safety Precautions,**
 Please see Data Files

Explanation of Part Numbers

- ERJ2LW, 3LW, 6LW, 2BW, 3BW, 6BW, 8BW, 6CW, 8CW
 <High power (double-sided resistive elements structure) type>

	1	2	3	4	5	6	7	8	9	10	11	12
	E	R	J	2	B	W	G	R	0	4	7	X

Product Code	Code	Inch	Power Rating	Resistance Value	Resistance Tolerance		Resistance Value Shown by 4 digits or letters. (Ex.) R047 : 0.047 Ω =47m Ω	Packaging Methods		
					Code	Tolerance		Code	Packaging	Part No.
Thick Film Chip Resistors	2LW	0402	0.2 W	10m Ω	D	$\pm 0.5\%$ *		X	Pressed Carrier Taping 2 mm pitch, 10,000 pcs.	ERJ2LW
	3LW	0603	0.25 W	5m Ω , 10m Ω	F	$\pm 1\%$				ERJ2BW
	6LW	0805	0.5 W	5, 6, 7, 8, 9m Ω	G	$\pm 2\%$		V	Punched Carrier Taping 4 mm pitch, 5,000 pcs.	ERJ3LW
	2BW	0402	0.25 W	47m Ω to 100m Ω	J	$\pm 5\%$				ERJ6LW
	3BW	0603	0.33 W	20m Ω to 100m Ω	* Please refer to the rating table for the resistance tolerance					ERJ3BW
	6BW	0805	0.5 W	10m Ω to 100m Ω						ERJ6BW
	8BW	1206	1 W	10m Ω to 100m Ω	ERJ8BW					
	6CW	0805	0.5 W	10m Ω to 30m Ω	ERJ6CW					
8CW	1206	1 W	10m Ω to 50m Ω	ERJ8CW						

- ERJ2BS/2BQ, 3BS/3BQ, 6BS/6BQ, 8BS/8BQ, 14BS/14BQ, 6D, 3R, 6R, 8R, 14R, 12R, 12Z, 1TR
<High power type/Standard type>

1	2	3	4	5	6	7	8	9	10	11
E	R	J	8	R	Q	F	R	2	2	V

Product Code	Size, Power Rating			Resistance Value		Resistance Tolerance		Packaging Methods		
Thick Film Chip Resistors	Type	Inch	Power R.	Code	Res. Value	Code	Tolerance	Code	Packaging	Part No.
	2B	0402	0.166 W	S	0.1 Ω to 0.2 Ω	D	± 0.5 %*	X	Punched Carrier Taping 2 mm pitch, 10,000 pcs.	ERJ2B
	3B	0603	0.25 W	Q	0.22 Ω to 9.1 Ω*	F	± 1 %	V	Punched Carrier Taping 4 mm pitch, 5,000 pcs.	ERJ3B/3R ERJ6D/6B/6R ERJ8B/8R
	3R	0603	0.1 W	* 2B : 0.22 Ω to 1.0 Ω		G	± 2 %	U	Embossed Carrier Taping 4 mm pitch, 5,000 pcs.	ERJ14B/14R ERJ12R ERJ12Z
	6D	0805	0.5 W			J	± 5 %			
	6B	0805	0.33 W			* Please refer to the rating table for the resistance tolerance				
	6R	0805	0.125 W							
	8B	1206	0.5 W							
	8R	1206	0.25 W							
	14B	1210	0.5 W							
	14R	1210	0.25 W							
	12R	1812	0.5 W							
	12Z	2010	0.5 W							
	1TR	2512	1 W							

Resistance Value	
Shown by 3 digits or letters. Only when it is D (E24, E96) or F (E96), shown by 4 digits or letters. (Ex.) R22 : 0.22 Ω R102 : 0.102 Ω	

- ERJL03, L06, L08, L14, L12, L1D, L1W <Low TCR type>

1	2	3	4	5	6	7	8	9	10	11	12
E	R	J	L	1	4	K	J	5	0	M	U

Product Code	Size, Power Rating			Code	Res. Value	Resistance Tolerance		Packaging Methods		
Thick Film Chip Resistors	Type	Inch	Power R.	K	Std.	Code	Tolerance	Code	Packaging	Part No.
	L03	0603	0.2 W		20m Ω, 22m Ω, 33m Ω, 39m Ω, 47m Ω, 50m Ω, 100m Ω	F	± 1 %	V	Punched Carrier Taping 4 mm pitch, 5,000 pcs.	ERJL03 ERJL06 ERJL08
	L06	0805	0.25 W	* L03, L06, L08 : 47m Ω to 100m Ω L1D, L1W : 40m Ω to 100m Ω	U	± 5 %	U	Embossed Carrier Taping 4 mm pitch, 5,000 pcs.	ERJL14 ERJL12 ERJL1D	
	L08	1206	0.33 W		20m Ω to 100m Ω*					
	L14	1210	0.33 W							
	L12	1812	0.5 W							
	L1D	2010	0.5 W							
	L1W	2512	1 W							

Resistance Value	
Shown by 3 digits or letters. (Ex.) 50M:50m Ω, 10 C:100m Ω	

Ratings

<High power (double-sided resistive elements structure) type>

Part No. (inch size)	Power Rating ⁽²⁾ at 70 °C (W)	Resistance Tolerance (%)	Resistance ⁽¹⁾ Range (Ω)	T.C.R. (× 10 ⁻⁶ /°C)	Category Temperature Range (°C)	AEC-Q200 Grade
ERJ2LW (0402)	0.2	±1, ±2, ±5	10m	0 to 500	-55 to +125	Grade 1
ERJ3LW (0603)	0.25	±1, ±2, ±5	5m	0 to 700	-55 to +125	Grade 1
			10m	0 to 300	-55 to +125	
ERJ6LW (0805)	0.5	±1, ±2, ±5	5, 6, 7, 8, 9m	0 to 300	-55 to +125	Grade 1
ERJ2BW (0402)	0.25	±1, ±2, ±5	47m to 100m (E24)	±300	-55 to +155	Grade 0
ERJ3BW (0603)	0.33	±1, ±2, ±5	20m to 100m (E24)	20m Ω ≤ R < 39m Ω : ±250 39m Ω ≤ R ≤ 100m Ω : ±150	-55 to +155	Grade 0
ERJ6BW (0805)	0.5	±1, ±2, ±5	10m to 100m (E24)	10m Ω ≤ R < 15m Ω : ±300 15m Ω ≤ R ≤ 100m Ω : ±200	-55 to +155	Grade 0
ERJ8BW (1206)	1	±1, ±2, ±5	10m to 100m (E24)	10m Ω ≤ R < 20m Ω : ±200	-55 to +155	Grade 0
				20m Ω ≤ R < 47m Ω : ±150 47m Ω ≤ R ≤ 100m Ω : ±100		
ERJ6CW (0805)	0.5	±0.5, ±1, ±2, ±5	10m to 30m (E24)	±75	-55 to +125	Grade 1
ERJ8CW (1206)	1	±1, ±2, ±5	10m to 50m (E24)	±75	-55 to +125	Grade 1

(1) Please contact us when resistors of irregular series are needed.

(2) Use it on the condition that the case temperature is below the upper category temperature.

- Rated Continuous Working Voltage (RCWV) shall be determined from RCWV = √ Power Rating × Resistance Values.
- Overload Test Voltage (OTV) shall be determined from OTV = Specified Magnification (refer to performance) × RCWV.

Design and specifications are each subject to change without notice. Ask factory for the current technical specifications before purchase and/or use.

Should a safety concern arise regarding this product, please be sure to contact us immediately.

Ratings

<High power type>

Part No. (inch size)	Power Rating ⁽²⁾ at 70 °C (W)	Resistance ⁽³⁾ Tolerance (%)	Resistance ⁽¹⁾ Range (Ω)	T.C.R. (× 10 ⁻⁶ /°C)	Category Temperature Range (°C)	AEC-Q200 Grade
ERJ2BS (0402)	0.166	±1, ±2, ±5	0.10 to 0.20 (E24)	±300	-55 to +155	Grade 0
ERJ2BQ (0402)			0.22 to 1.0 (E24)	±250		
ERJ3BS (0603)	0.25	±1, ±2, ±5	0.10 to 0.20 (E24)	±300	-55 to +155	Grade 0
ERJ3BQ (0603)			0.22 to 0.91 (E24)			
			1.0 to 9.1 (E24)	±200		
ERJ6DS (0805)	0.5	±0.5, ±1, ±2, ±5	0.10 to 0.20 (E24, E96)	±150	-55 to +155	Grade 0
ERJ6DQ (0805)			0.22 to 9.1 (E24, E96)	±100		
ERJ6BS (0805)	0.33	±1, ±2, ±5	0.10 to 0.20 (E24)	±250	-55 to +155	Grade 0
ERJ6BQ (0805)			0.22 to 0.91 (E24)			
			1.0 to 9.1 (E24)	±200		
ERJ8BS (1206)	0.5	±1, ±2, ±5	0.10 to 0.20 (E24)	±250	-55 to +155	Grade 0
ERJ8BQ (1206)			0.22 to 0.91 (E24)			
			1.0 to 9.1 (E24)	±200		
ERJ14BS (1210)	0.5	±1, ±2, ±5	0.10 to 0.20 (E24)	±200	-55 to +155	Grade 0
ERJ14BQ (1210)			0.22 to 0.91 (E24)			
			1.0 to 9.1 (E24)	±100		

(1) Please contact us when resistors of irregular series are needed.

(2) Use it on the condition that the case temperature is below the upper category temperature.

(3) E96 series also have ±0.5 %, ±1 % line-up.

- Rated Continuous Working Voltage (RCWV) shall be determined from $RCWV = \sqrt{\text{Power Rating} \times \text{Resistance Values}}$.
- Overload Test Voltage (OTV) shall be determined from $OTV = \text{Specified Magnification (refer to performance)} \times RCWV$.

<Standard type>

Part No. (inch size)	Power Rating ⁽²⁾ at 70 °C (W)	Resistance Tolerance (%)	Resistance ⁽¹⁾ Range (Ω)	T.C.R. (× 10 ⁻⁶ /°C)	Category Temperature Range (°C)	AEC-Q200 Grade
ERJ3RS (0603)	0.1	±1, ±2, ±5	0.10 to 0.20 (E24)	±300	-55 to +155	Grade 0
ERJ3RQ (0603)			0.22 to 0.91 (E24)			
			1.0 to 9.1 (E24)	±200		
ERJ6RS (0805)	0.125	±1, ±2, ±5	0.10 to 0.20 (E24)	±250	-55 to +155	Grade 0
ERJ6RQ (0805)			0.22 to 0.91 (E24)			
			1.0 to 9.1 (E24)	±200		
ERJ8RS (1206)	0.25	±1, ±2, ±5	0.10 to 0.20 (E24)	±250	-55 to +155	Grade 0
ERJ8RQ (1206)			0.22 to 0.91 (E24)			
			1.0 to 9.1 (E24)	±200		
ERJ14RS (1210)	0.25	±1, ±2, ±5	0.10 to 0.20 (E24)	±200	-55 to +155	Grade 0
ERJ14RQ (1210)			0.22 to 0.91 (E24)			
			1.0 to 9.1 (E24)	±100		
ERJ12RS (1812)	0.5	±1, ±2, ±5	0.10 to 0.20 (E24)	±200	-55 to +155	Grade 0
ERJ12RQ (1812)			0.22 to 0.91 (E24)			
			1.0 to 9.1 (E24)	±100		
ERJ12ZS (2010)	0.5	±1, ±2, ±5	0.10 to 0.20 (E24)	±200	-55 to +155	Grade 0
ERJ12ZQ (2010)			0.22 to 0.91 (E24)			
			1.0 to 9.1 (E24)	±100		
ERJ1TRS (2512)	1	±1, ±2, ±5	0.10 to 0.20 (E24)	±200	-55 to +155	Grade 0
ERJ1TRQ (2512)			0.22 to 0.91 (E24)			
			1.0 to 9.1 (E24)	±100		

(1) Please contact us when resistors of irregular series are needed.

(2) Use it on the condition that the case temperature is below the upper category temperature.

- Rated Continuous Working Voltage (RCWV) shall be determined from $RCWV = \sqrt{\text{Power Rating} \times \text{Resistance Values}}$.
- Overload Test Voltage (OTV) shall be determined from $OTV = \text{Specified Magnification (refer to performance)} \times RCWV$.

<Low TCR type>

Part No. (inch size)	Power Rating ⁽²⁾ at 70 °C (W)	Resistance Tolerance (%)	Resistance Range ⁽¹⁾ (Ω)	T.C.R. ($\times 10^{-6}/^{\circ}\text{C}$)	Category Temperature Range (°C)	AEC-Q200 Grade
ERJL03 (0603)	0.2	$\pm 1, \pm 5$	47m to 100m	± 200	-55 to +125	Grade 1
ERJL06 (0805)	0.25	$\pm 1, \pm 5$	47m to 100m	± 100	-55 to +125	Grade 1
ERJL08 (1206)	0.33	$\pm 1, \pm 5$	47m to 100m	± 100	-55 to +125	Grade 1
ERJL14 (1210)	0.33	$\pm 1, \pm 5$	20m to 100m	R < 47m Ω : ± 300 R ≥ 47m Ω : ± 100	-55 to +125	Grade 1
ERJL12 (1812)	0.5	$\pm 1, \pm 5$	20m to 100m		-55 to +125	Grade 1
ERJL1D (2010)	0.5	$\pm 1, \pm 5$	40m to 100m		-55 to +125	Grade 1
ERJL1W (2512)	1	$\pm 1, \pm 5$	40m to 100m		-55 to +125	Grade 1

(1) Standard R.V. : 20m Ω, 22m Ω, 33m Ω, 39m Ω, 47m Ω, 50m Ω, 100m Ω, Custom R.V. : Each 1m Ω within upper range.

(2) Use it on the condition that the case temperature is below the upper category temperature.

- Rated Continuous Working Voltage (RCWV) shall be determined from $\text{RCWV} = \sqrt{\text{Power Rating} \times \text{Resistance Values}}$.
- Overload Test Voltage (OTV) shall be determined from $\text{OTV} = \text{Specified Magnification (refer to performance)} \times \text{RCWV}$.

Construction

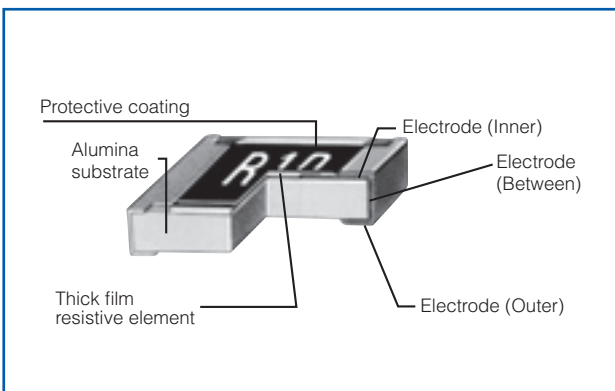

Power Derating Curve

For resistors operated in ambient temperatures above 70 °C, power rating shall be derated in accordance with the figure below.

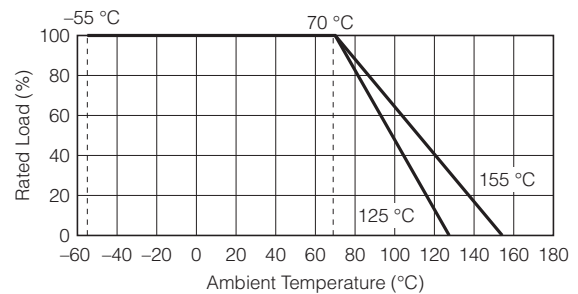

Dimensions in mm (not to scale)

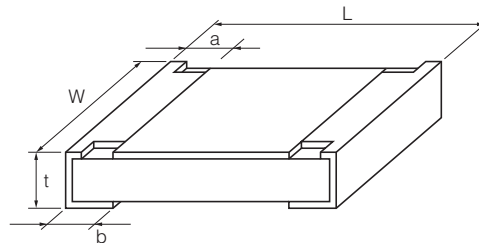

Part No.	Dimensions (mm)					Mass(Weight) [g/1000 pcs.]
	L	W	a	b	t	
ERJ2LW	1.00 $^{\pm 0.10}$	0.50 $^{+0.10}_{-0.05}$	0.25 $^{\pm 0.10}$	0.25 $^{\pm 0.10}$	0.40 $^{\pm 0.05}$	0.8
ERJ2BW	1.00 $^{\pm 0.10}$	0.50 $^{+0.10}_{-0.05}$	0.24 $^{\pm 0.10}$	0.24 $^{\pm 0.10}$	0.35 $^{\pm 0.05}$	0.8
ERJ2BS	1.00 $^{\pm 0.10}$	0.50 $^{+0.10}_{-0.05}$	0.20 $^{\pm 0.10}$	0.27 $^{\pm 0.10}$	0.35 $^{\pm 0.05}$	0.8
ERJ2BQ			0.20 $^{\pm 0.10}$	0.27 $^{\pm 0.10}$		
ERJ3LW (5m Ω)	1.60 $^{\pm 0.15}$	0.80 $^{\pm 0.15}$	0.50 $^{\pm 0.20}$	0.50 $^{\pm 0.20}$	0.55 $^{\pm 0.10}$	3
ERJ3LW (10m Ω)	1.60 $^{\pm 0.15}$	0.80 $^{\pm 0.15}$	0.40 $^{\pm 0.20}$	0.40 $^{\pm 0.20}$	0.55 $^{\pm 0.10}$	3
ERJ3BW			0.40 $^{\pm 0.20}$	0.40 $^{\pm 0.20}$		
ERJ3R	1.60 $^{\pm 0.15}$	0.80 $^{+0.15}_{-0.05}$	0.30 $^{\pm 0.20}$	0.30 $^{\pm 0.15}$	0.45 $^{\pm 0.10}$	2
ERJ3B						
ERJL03	2.00 $^{\pm 0.20}$	1.25 $^{\pm 0.20}$	0.63 $^{\pm 0.20}$	0.63 $^{\pm 0.20}$	0.70 $^{\pm 0.10}$	6
ERJ6LW			0.63 $^{\pm 0.20}$	0.63 $^{\pm 0.20}$		
ERJ6BW	2.00 $^{\pm 0.20}$	1.25 $^{\pm 0.20}$	0.55 $^{\pm 0.20}$	0.55 $^{\pm 0.20}$	0.65 $^{\pm 0.10}$	6
ERJ6CW (10 to 13m Ω)			0.60 $^{\pm 0.20}$	0.60 $^{\pm 0.20}$		
ERJ6CW (15 to 30m Ω)	2.05 $^{\pm 0.20}$	1.30 $^{\pm 0.20}$	0.45 $^{\pm 0.20}$	0.45 $^{\pm 0.20}$	0.65 $^{\pm 0.10}$	6
ERJ6D			0.45 $^{\pm 0.20}$	0.45 $^{\pm 0.20}$		
ERJ6R	2.00 $^{\pm 0.20}$	1.25 $^{\pm 0.10}$	0.40 $^{\pm 0.20}$	0.55 $^{\pm 0.25}$	0.60 $^{\pm 0.10}$	5
ERJ6B						
ERJL06						

Part No.	Dimensions (mm)					Mass(Weight) [g/1000 pcs.]
	L	W	a	b	t	
ERJ8BW	3.20 $^{\pm 0.20}$	1.60 $^{\pm 0.20}$	1.00 $^{\pm 0.20}$	1.00 $^{\pm 0.20}$	0.65 $^{\pm 0.10}$	13
ERJ8CW (10 to 16m Ω)	3.20 $^{\pm 0.20}$	1.60 $^{\pm 0.20}$	1.10 $^{\pm 0.20}$	1.10 $^{\pm 0.20}$	0.65 $^{\pm 0.10}$	13
ERJ8CW (18 to 50m Ω)			0.60 $^{\pm 0.20}$	0.60 $^{\pm 0.20}$		
ERJ8R	3.20 $^{+0.05}_{-0.20}$	1.60 $^{+0.05}_{-0.15}$	0.50 $^{\pm 0.20}$	0.50 $^{\pm 0.20}$	0.60 $^{\pm 0.10}$	10
ERJ8B						
ERJL08						
ERJ14R	3.20 $^{\pm 0.20}$	2.50 $^{\pm 0.20}$	0.50 $^{\pm 0.20}$	0.50 $^{\pm 0.20}$	0.60 $^{\pm 0.10}$	16
ERJ14B						
ERJL14	4.50 $^{\pm 0.20}$	3.20 $^{\pm 0.20}$	0.50 $^{\pm 0.20}$	0.50 $^{\pm 0.20}$	0.60 $^{\pm 0.10}$	27
ERJ12R						
ERJL12	5.00 $^{\pm 0.20}$	2.50 $^{\pm 0.20}$	0.60 $^{\pm 0.20}$	0.60 $^{\pm 0.20}$	0.60 $^{\pm 0.10}$	27
ERJ12Z ERJL1D						
ERJ1TR	6.40 $^{\pm 0.20}$	3.20 $^{\pm 0.20}$	0.65 $^{\pm 0.20}$	0.60 $^{\pm 0.20}$	0.60 $^{\pm 0.10}$	45
ERJL1W	6.40 $^{\pm 0.20}$	3.20 $^{\pm 0.20}$	0.65 $^{\pm 0.20}$	1.30 $^{\pm 0.20}$	1.10 $^{\pm 0.10}$	79

Design and specifications are each subject to change without notice. Ask factory for the current technical specifications before purchase and/or use.
Should a safety concern arise regarding this product, please be sure to contact us immediately.

Performance

- ERJ2LW, 3LW, 6LW, 2BW, 3BW, 6BW, 8BW, 6CW, 8CW
<High power (double-sided resistive elements structure) type>

Test Item	Performance Requirements	Test Conditions
Resistance	Within Specified Tolerance	20 °C
T. C. R.	Within Specified T. C. R.	+25 °C/+125 °C
Overload	±2%	Rated Voltage × 2.0, 5 s ERJ6LW : × 1.77, 5 s ERJ8BW (R > 0.05 Ω) : × 1.77, 5 s
Resistance to Soldering Heat	±1%	270 °C, 10 s
Rapid Change of Temperature	±1% ERJ2LW : ±2%	−55 °C (30 min.) / +155 °C (ERJ*LW, ERJ*CW : +125 °C) (30 min.), 100 cycles
High Temperature Exposure	±1%	+155 °C (ERJ*LW, ERJ*CW : +125 °C), 1000 h
Damp Heat, Steady State	±1%	60 °C, 90% to 95%RH, 1000 h
Load Life in Humidity	±3%	60 °C, 90% to 95%RH, Rated Voltage, 1.5 h ON/0.5 h OFF cycle, 1000 h
Endurance at 70 °C	±3%	70 °C, Rated Voltage, 1.5 h ON/0.5 h OFF cycle, 1000 h

- ERJ2BS/2BQ, 3BS/3BQ, 6BS/6BQ, 8BS/8BQ, 14BS/14BQ, 6D, 3R, 6R, 8R, 14R, 12R, 12Z, 1TR
<High power type/Standard type>

Test Item	Performance Requirements	Test Conditions
Resistance	Within Specified Tolerance	20 °C
T. C. R.	Within Specified T. C. R.	+25 °C/+125 °C
Overload	±2%	Rated Voltage × 2.5 (ERJ6D : × 1.77), 5 s
Resistance to Soldering Heat	±1%	270 °C, 10 s
Rapid Change of Temperature	±1%	−55 °C (30 min.) / +155 °C (30 min.), 100 cycles
High Temperature Exposure	±1%	+155 °C, 1000 h
Damp Heat, Steady State	±1%	60 °C, 90% to 95%RH, 1000 h
Load Life in Humidity	±3%	60 °C, 90% to 95%RH, Rated Voltage, 1.5 h ON/0.5 h OFF cycle, 1000 h
Endurance at 70 °C	±3%	70 °C, Rated Voltage, 1.5 h ON/0.5 h OFF cycle, 1000 h

- ERJL03, L06, L08, L14, L12, L1D, L1W <Low TCR type>

Test Item	Performance Requirements	Test Conditions
Resistance	Within Specified Tolerance	20 °C
T. C. R.	Within Specified T. C. R.	+25 °C/+125 °C
Overload	±2%	Rated Voltage × 2.5, 5 s
Resistance to Soldering Heat	±1%	270 °C, 10 s
Rapid Change of Temperature	±1%	−55 °C (30 min.) / +125 °C (30 min.), 100 cycles
High Temperature Exposure	±1%	+125 °C, 1000 h
Damp Heat, Steady State	±1%	60 °C, 90% to 95%RH, 1000 h
Load Life in Humidity	±3%	60 °C, 90% to 95%RH, Rated Voltage, 1.5 h ON/0.5 h OFF cycle, 1000 h
Endurance at 70 °C	±3%	70 °C, Rated Voltage, 1.5 h ON/0.5 h OFF cycle, 1000 h

Current Sensing Resistors, Metal Plate Type

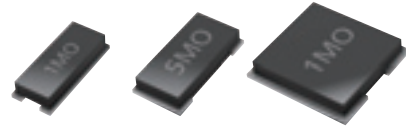

Type: ERJ MS4, MS6, MB1

Features

- Ideal for current sensing solution
- Small case size with high power
- Metal plate bonding technology. Excellent long term stability
- Outer Resin with high heat dissipation. Wide temperature range (-65 °C to +170 °C)
- AEC-Q200 qualified
- RoHS compliant
- ISO9001, ISO/TS16949 certified

As for Packaging Methods, Soldering Conditions and Safety Precautions,

Please see Data Files

Explanation of Part Numbers

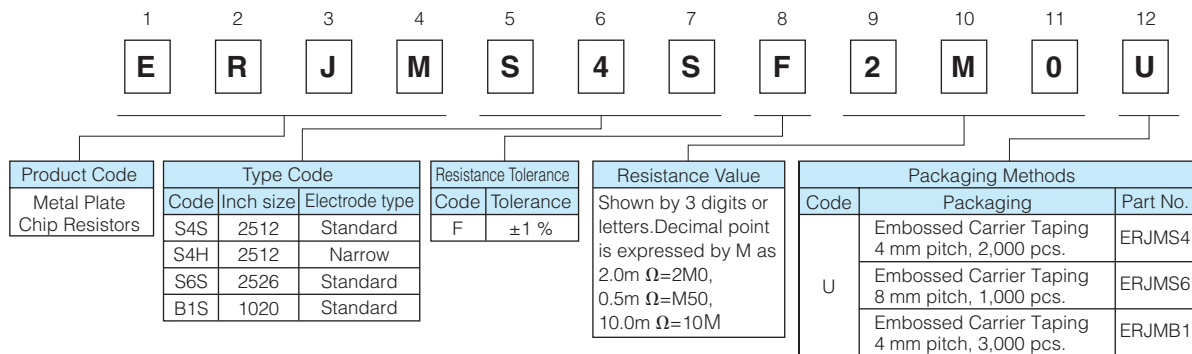

Ratings

Part No. (inch size)	Power Rating at 70 °C (W)	Resistance Range (mΩ)	Resistance Tolerance (%)	T.C.R. (×10 ⁻⁶ /°C)	Category Temperature Range (°C)	Terminal temp. upper limit (°C)
ERJMS4S (2512)	3	1, 2, 3, 4	F : ±1	±75	-65 to +170	130
ERJMS4H (2512)	3	5, 6	F : ±1	±75	-65 to +170	130
	2	7, 8, 9, 10	F : ±1	±75	-65 to +170	100
ERJMS6S (2526)	5	0.5, 1, 2	F : ±1	±75	-65 to +170	130
ERJMB1S (1020)	2	1, 2, 3, 4, 5	F : ±1	±75	-65 to +170	130

* Please contact us when resistors of irregular series are needed.

Power Derating Curve

If the terminal temperature of the resistor is more than terminal temperature upper limit value of the rated table, please reduce the rated power according to the Power Derating Curve shown in the figure on the right.

<Supplemented>

In the case of the temperature measurement of the terminal portion of the resistor, Please perform under the following conditions.

- 1) Terminal temperature measurement, please apply the temperature of the higher of either the left or right electrode upper surface of the resistor.
- 2) Please measure the temperature of the resistor in the land pattern printed of circuit board and plan to use by real conditions.

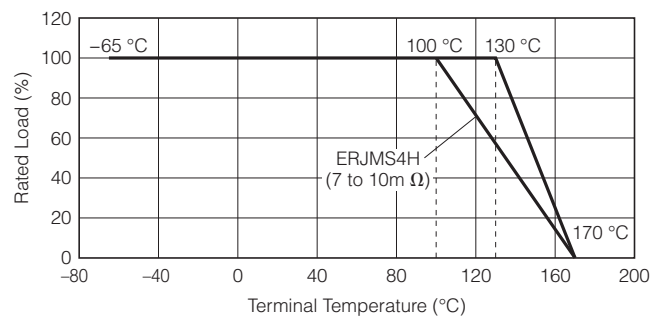

Panasonic Current Sensing Resistors, Metal Plate Type

Construction

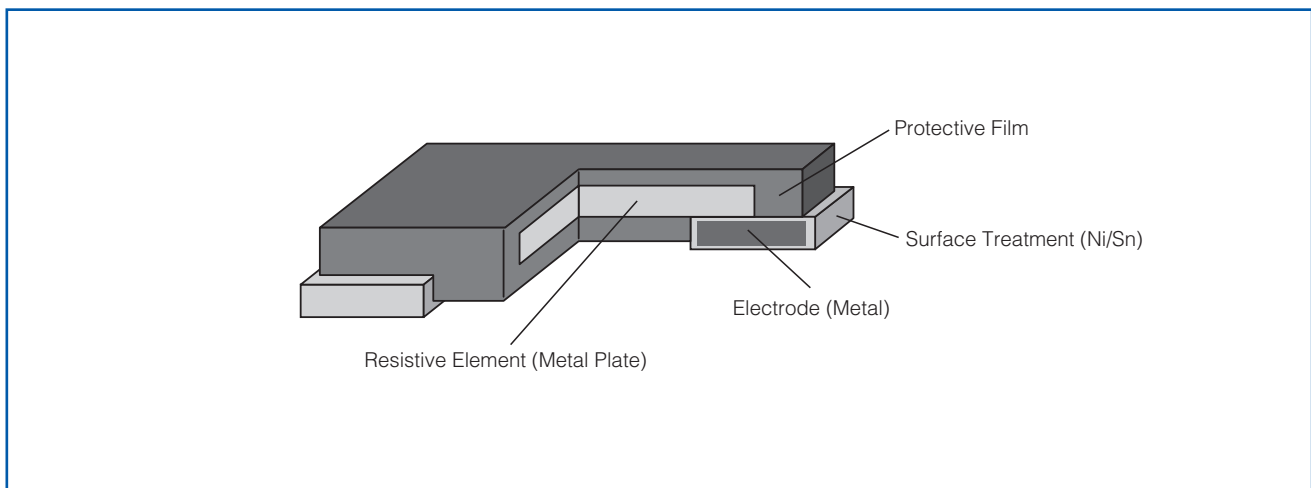

Dimensions in mm (not to scale), Recommended Land Pattern

● ERJMS4S/ERJMS4H

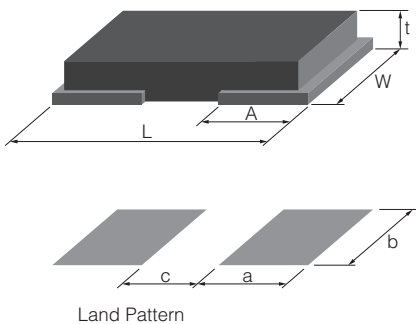

● ERJMS6S

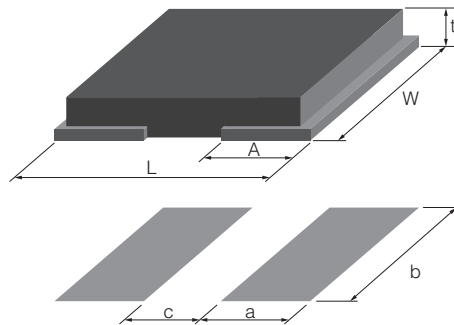

● ERJMB1S

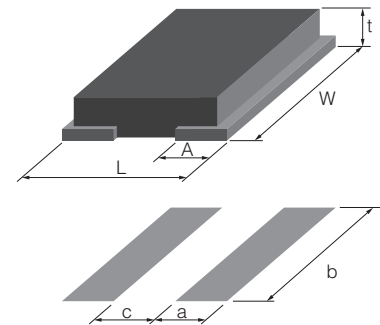

Part No. (inch size)	Dimension (mm)				Recommended Land Pattern (mm)			Mass (Weight) (g/1000 pcs.)
	L	W	A	t	a	b	c	
ERJMS4S (2512)	6.40±0.25	3.20±0.25	2.20±0.25	1.20±0.15	2.7	3.4	2.0	120
ERJMS4H (2512)	6.40±0.25	3.20±0.25	1.25±0.25	1.20±0.15	1.7	3.4	4.0	115
ERJMS6S (2526)	6.40±0.25	6.80±0.25	2.20±0.25	1.20±0.15	2.7	7.0	2.0	260
ERJMB1S (1020)	2.55±0.25	5.00±0.25	0.68 ^{+0.15} _{-0.20}	0.90±0.15	1.15	5.5	1.1	40

Typical Temperature dependence of electrical resistance

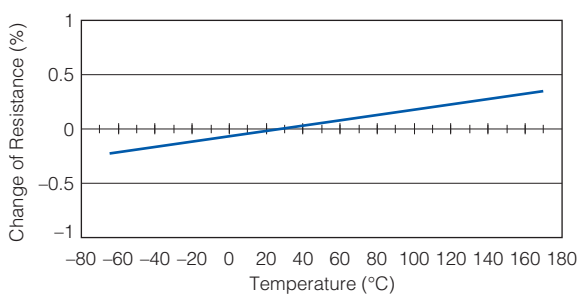

Long-term stability

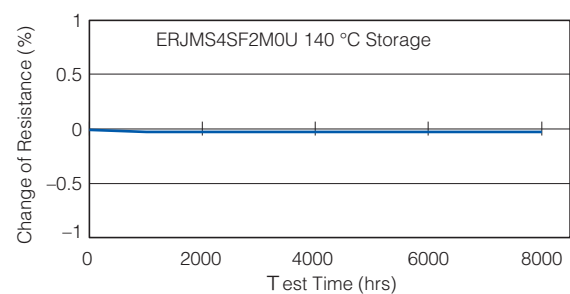

Maximum pulse energy respectively pulse power for continuous operation

Reference Data
 Condition : Room Temperature, OFF : 10 s, 1000 cycle, Wave form : Square
 Change of Resistance = $\pm 1\%$

● ERJMS4 type

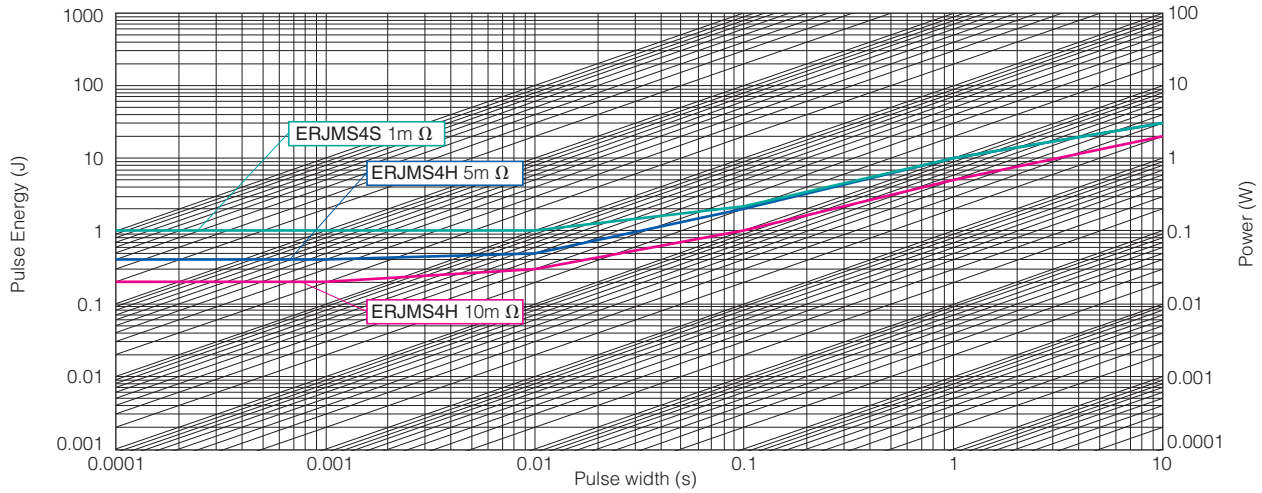

● ERJMS6 type

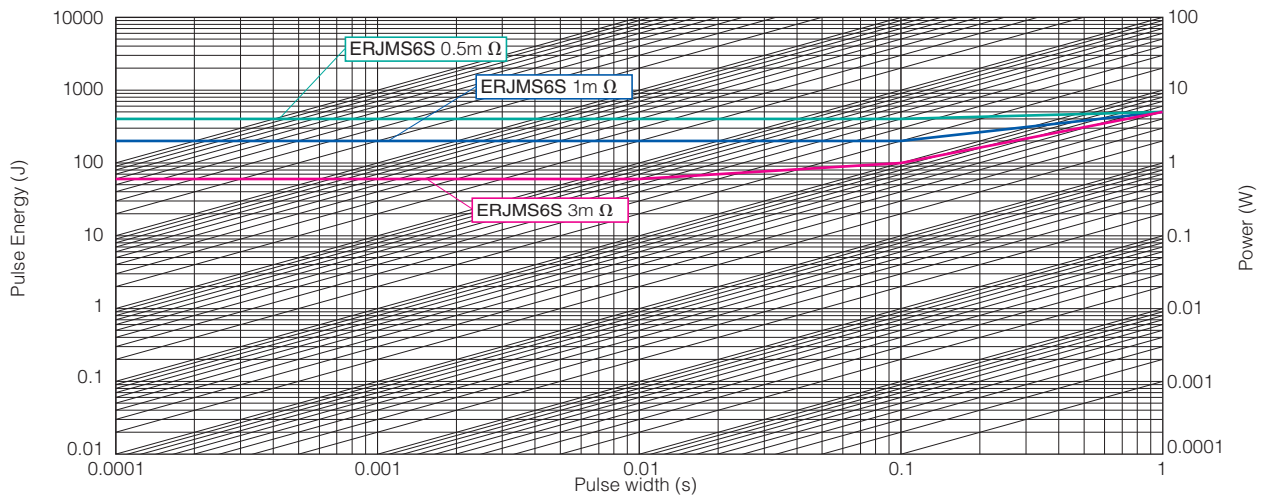

● ERJMB1 type

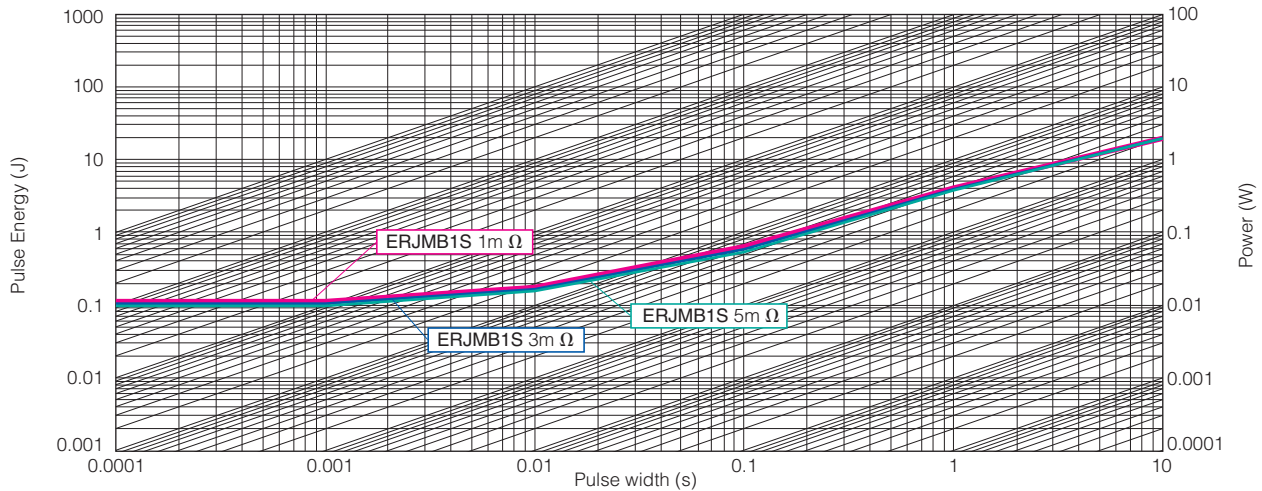

Performance (AEC-Q200)

● ERJMS4, ERJMS6 type

Test Item	Test Condition	Specification	Typical value
Thermal Shock	-55 °C/155 °C, 1000cycles	±1 %	0.20 %
Overload	3 × Rated Power, 5 sec	±0.5 %	0.10 %
Solderability	245 °C, 3 sec	> 95% coverage	> 95% coverage
Resistance to Solvents	MIL-STD-202 method 215, 2.1a, 2.1d	No damage	No damage
Low Temperature Storage and Operation	-65 °C, 24 h	±0.5 %	0.03 %
Resistance to Soldering Heat	MIL-STD-202 method 210 (260 °C, 10s)	±0.5 %	0.10 %
Moisture Resistance	MIL-STD-202 method 106	±0.5 %	0.10 %
Shock	MIL-STD-202 method 213-A	±0.5 %	0.10 %
Vibration, High Frequency	10 to 2000 (Hz)	±0.5 %	0.05 %
Life	70 °C, Rated Power, 2000 h	±1 %	0.30 %
Storage Life at Elevated Temperature	170 °C, 2000 h	±1 %	0.30 %
High Temperature Characteristics	140 °C, 2000 h	±0.5 %	0.05 %
Frequency Characteristics	Inductance	< 5 nH	< 2 nH

● ERJMB1 type

Test Item	Test Condition	Specification	Typical value
Thermal Shock	-55 °C/155 °C, 1000cycles	±1 %	0.30 %
Overload	2.5 × Rated Power, 5 sec	±1 %	0.30 %
Solderability	245 °C, 3 sec	> 95% coverage	> 95% coverage
Resistance to Solvents	MIL-STD-202 method 215, 2.1a, 2.1d	No damage	No damage
Low Temperature Storage and Operation	-65 °C, 24 h	±0.5 %	0.03 %
Resistance to Soldering Heat	MIL-STD-202 method 210 (260 °C, 10s)	±0.5 %	0.10 %
Moisture Resistance	MIL-STD-202 method 106	±0.5 %	0.10 %
Shock	MIL-STD-202 method 213-A	±0.5 %	0.10 %
Vibration, High Frequency	10 to 2000 (Hz)	±0.5 %	0.05 %
Life	70 °C, Rated Power, 2000 h	±1 %	0.30 %
Storage Life at Elevated Temperature	170 °C, 2000 h	±1 %	0.30 %
High Temperature Characteristics	140 °C, 2000 h	±0.5 %	0.05 %
Frequency Characteristics	Inductance	< 5 nH	< 2 nH

Temperature Rise

● ERJMS4HF5M0U

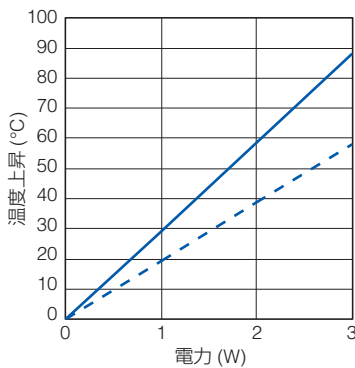

● ERJMS6SF2M0U

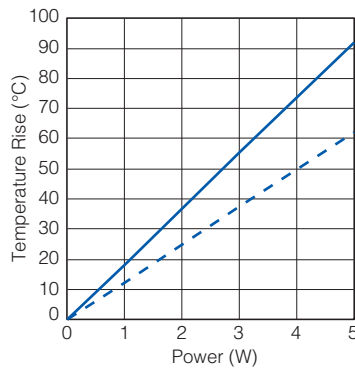

● ERJMB1SF3M0U

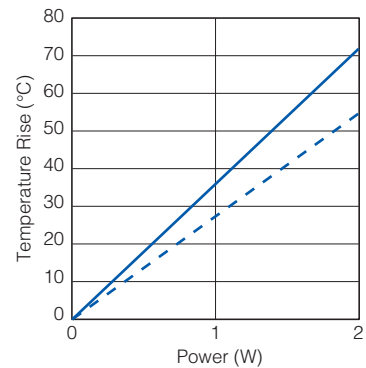

① ———— <Condition>
 Base material : FR-4 (t1.6mm)
 Copper Thickness : 70 μm, Two layer

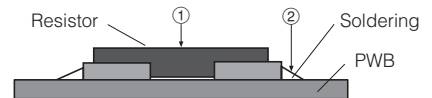

Sense terminal-Layout

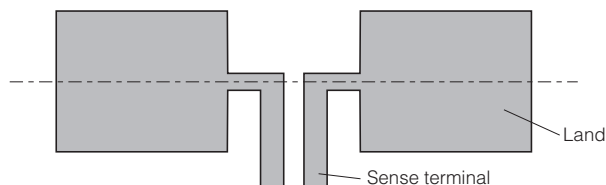

Current Sensing Resistors, Metal Plate Type

Type: **ERJM1W**



Features

- Low resistance values and high precision (1 mΩ to 20 mΩ)
- Stable resistance not influenced by measurement position
- High heat emission
- Low profile, strong body
- Inductance less than 1.0 nH for the metal plate structure
- RoHS compliant

As for Packaging Methods, Soldering Conditions and Safety Precautions,

Please see Data Files

Explanation of Part Numbers

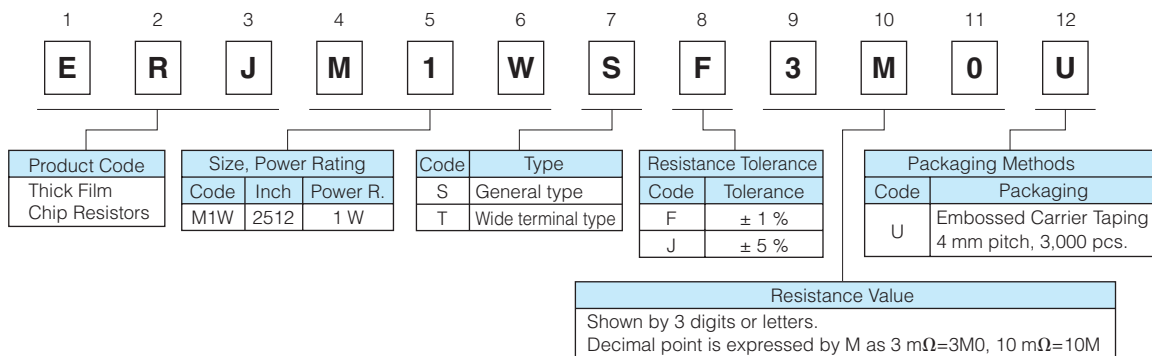

Ratings

Part No. (inch size)	Power Rating at 70 °C (W)	Standard Resistance (mΩ)	Resistance Tolerance (%)	T.C.R. (×10 ⁻⁶ /°C)	Category Temperature Range (°C)	Circuit board of use
ERJM1WS (2512)	1	3, 4	F: ±1, J: ±5	±350	-55 to +170	You should use the aluminum substrate when the added wattage exceeds 0.5 W.
		5, 6, 10, 15, 20		±100		
ERJM1WT (2512)		1, 1.5		350±100		
		2, 3, 4		100±50		

* Please contact the factory for other values and the range

Power Derating Curve

For resistors operated in ambient temperatures above 70 °C, power rating shall be derated in accordance with the figure on the right.

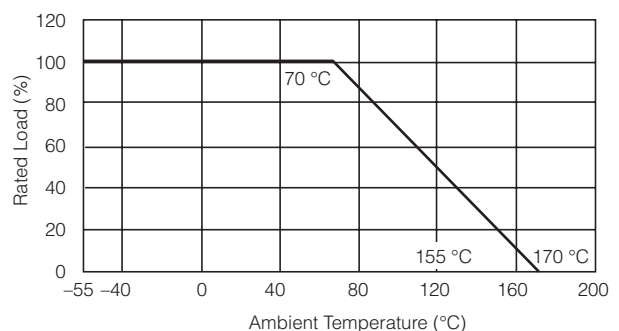

Construction

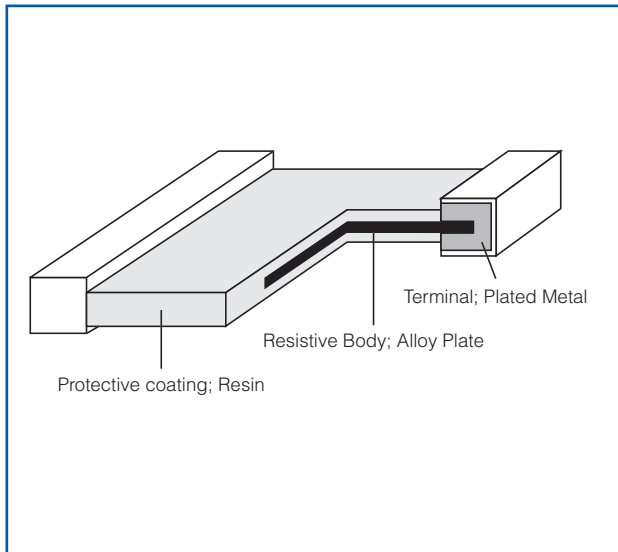

Dimensions in mm (not to scale)

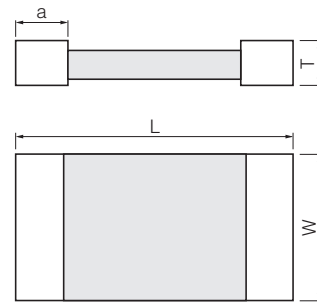

Type	Part No. (inch size)	Dimensions (mm)				Mass (Weight) [g/1000 pcs.]
		L	W	T	a	
S Type	ERJM1WS (2512)	6.40 \pm 0.25	3.20 \pm 0.25	0.80 \pm 0.30	1.00 \pm 0.25	70
T Type	ERJM1WT (2512)	6.40 \pm 0.40			2.10 \pm 0.30	

Recommended Land Pattern

- An example of a land pattern

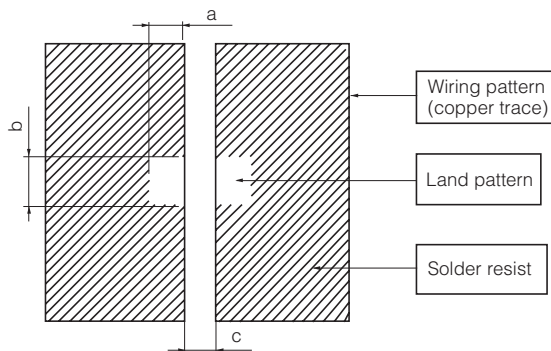

Part No.	Dimensions (mm)		
	a	b	c
ERJM1WS	2.1	3.4	4.2
ERJM1WT	3.1	3.4	2.2

Current Sensing Resistors, Metal Foil Type



Type: **ERJ MFBA**

Features

- Suitable for current sensing for smartphones and other small devices
- Unique metal foil process achieved high power and low temperature coefficient
- RoHS compliant
- ISO9001 certified

As for Packaging Methods, Soldering Conditions and Safety Precautions,

Please see Data Files

Explanation of Part Numbers

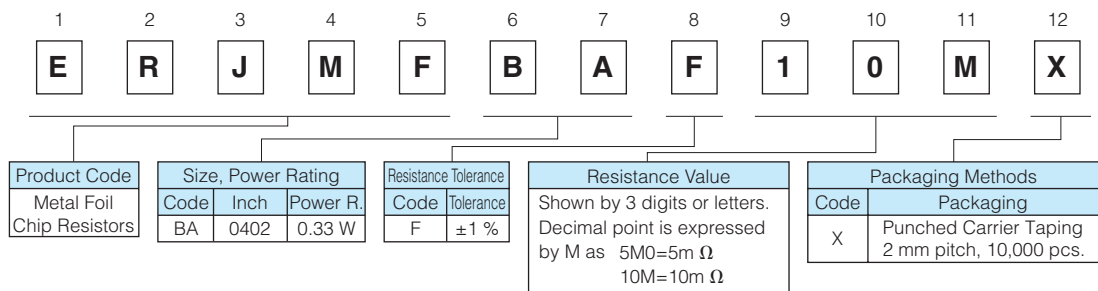

Ratings

Part No. (inch size)	Power Rating at 70 °C (W)	Resistance Range* (mΩ)	Resistance Tolerance (%)	T.C.R. (×10 ⁻⁶ /°C)	Category Temperature Range (°C)
ERJMFBA (0402)	0.33	5, 10, 20	F : ±1	±150	-55 to +125

* Use it on the condition that the case temperature is below 125 °C.

Power Derating Curve

If the ambient temperature of the resistor is more than ambient temperature upper limit value of the rated table, please reduce the rated power according to the Power Derating Curve shown in the figure on the right.

