

Chipsmall Limited consists of a professional team with an average of over 10 year of expertise in the distribution of electronic components. Based in Hongkong, we have already established firm and mutual-benefit business relationships with customers from,Europe,America and south Asia,supplying obsolete and hard-to-find components to meet their specific needs.

With the principle of “Quality Parts,Customers Priority,Honest Operation,and Considerate Service”,our business mainly focus on the distribution of electronic components. Line cards we deal with include Microchip,ALPS,ROHM,Xilinx,Pulse,ON,Everlight and Freescale. Main products comprise IC,Modules,Potentiometer,IC Socket,Relay,Connector.Our parts cover such applications as commercial,industrial, and automotives areas.

We are looking forward to setting up business relationship with you and hope to provide you with the best service and solution. Let us make a better world for our industry!



Contact us

Tel: +86-755-8981 8866 Fax: +86-755-8427 6832

Email & Skype: info@chipsmall.com Web: www.chipsmall.com

Address: A1208, Overseas Decoration Building, #122 Zhenhua RD., Futian, Shenzhen, China

図面番号 (DRAWING NO.) SJ114446

版数 VER.	年月日 DATE	CN NO.	変更内容 DESCRIPTION	製図 DR.	担当 CHK.	査閲 APPD.	承認 APPD.

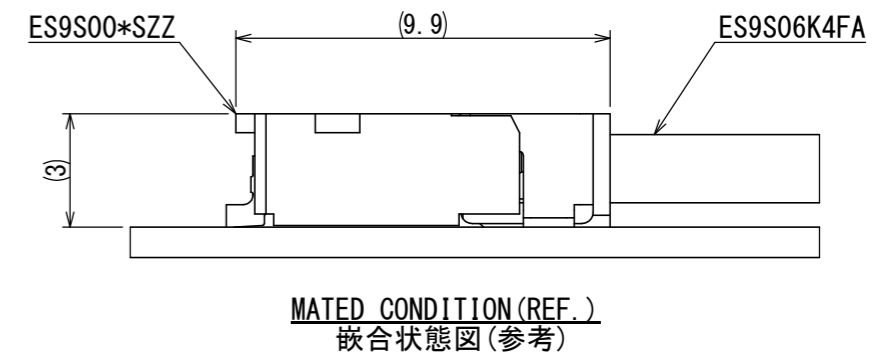
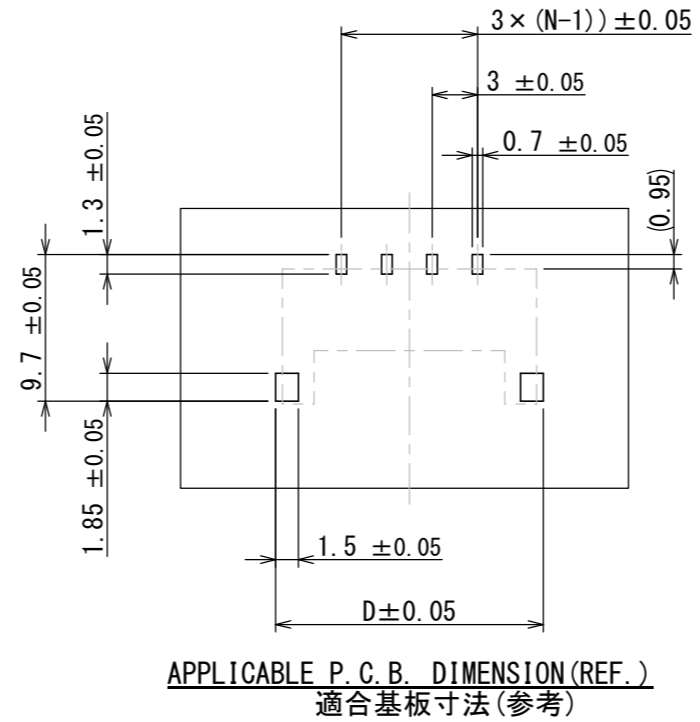
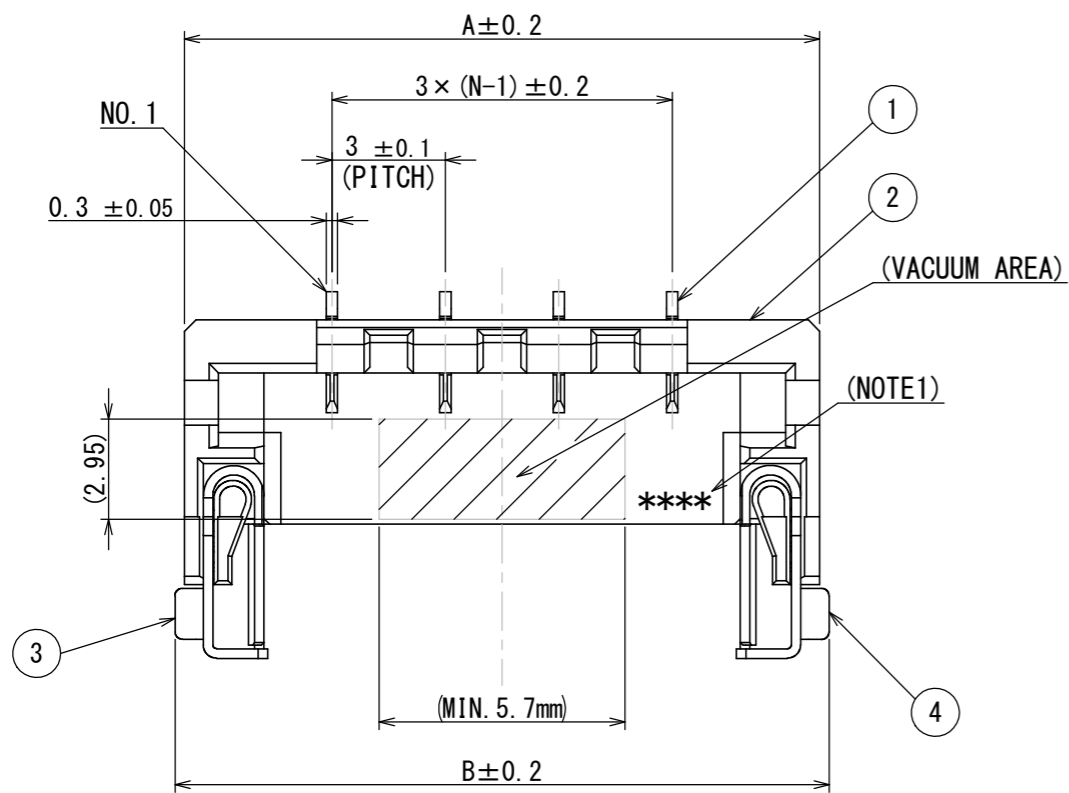

APPLICABLE P. C. B. DIMENSION (REF.)
適合基板寸法 (参考)

TABLE1

NO. OF CONTACTS	A	B	C	D
2	10.8	11.3	7.3	11.7
4	16.8	17.3	9.8	17.7

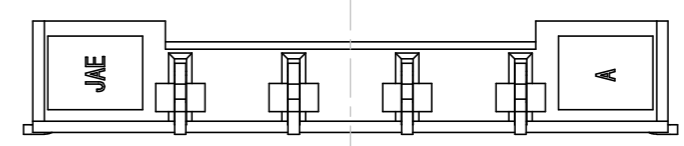
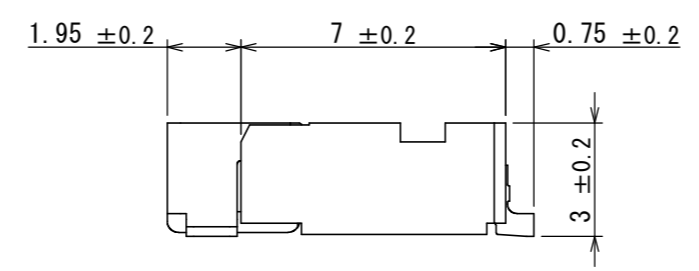
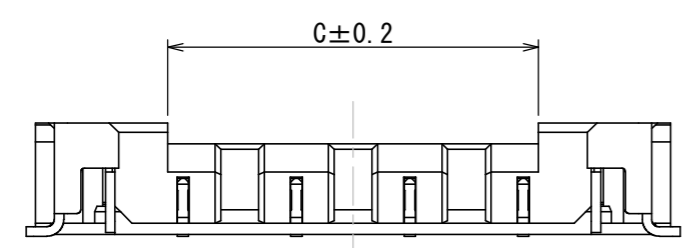

NOTE1. LOT MARKING
注1. 組立ロットを表示する

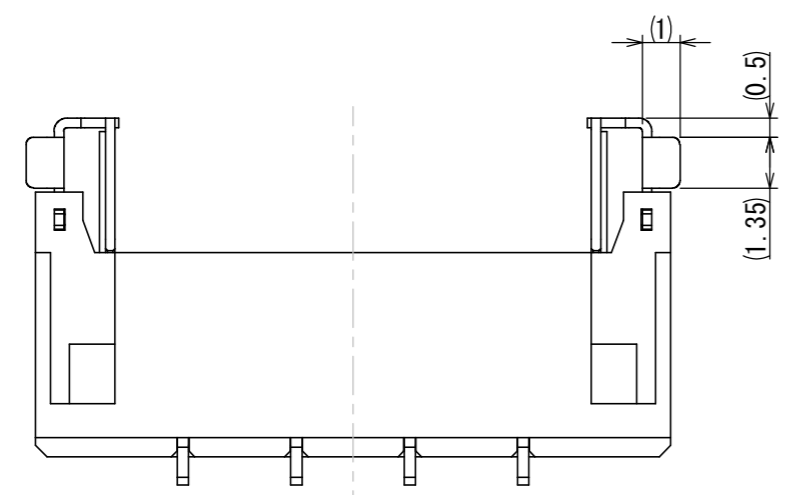

符号 NO.	名称 DESCRIPTION	個数 QTY.	材料 MATERIAL	仕上 FINISH	備考 REMARKS
4	HOLD DOWN R	1	COPPER ALLOY	LEAD FREE TIN ALLOY PLATING	
3	HOLD DOWN L	1	COPPER ALLOY	LEAD FREE TIN ALLOY PLATING	
2	INSULATOR	1	LCP		COLOR: IVORY
1	CONTACT	TABLE1	COPPER ALLOY	LEAD FREE TIN ALLOY PLATING	

仕様書 (SPECIFICATION) JACS-11001 JABL-11001		第1版 (ORIGINAL DATE) 29/AUG/2013		尺度 (SCALE) 5:1		シリーズ (SERIES) ES9		日本航空電子工業株式会社		SIZE A3	
一般公差 (GENERAL TOLERANCE)		製図 DR.		名称 (TITLE) ES9P00*VFZ		質量 (MASS)		JAE JAPAN AVIATION ELECTRONICS INDUSTRY, LTD.			
寸法 (DIMENSION)		担当 CHK. T. URANO		査閲 APPD. H. KANNO						承認 APPD. T. KUDOU	
角度 (ANGLES)		査閲 APPD. H. KANNO				承認 APPD. T. KUDOU		SJ114446			
単位 (UNIT) : mm		承認 APPD. T. KUDOU		質量 (MASS)		承認 APPD. T. KUDOU		SJ114446		1	

DCF-C-212H(12.08)

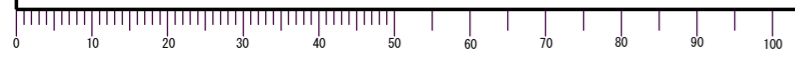

WISDOM承認 2013/09/03