



Chipsmall Limited consists of a professional team with an average of over 10 year of expertise in the distribution of electronic components. Based in Hongkong, we have already established firm and mutual-benefit business relationships with customers from,Europe,America and south Asia,supplying obsolete and hard-to-find components to meet their specific needs.

With the principle of "Quality Parts,Customers Priority,Honest Operation,and Considerate Service",our business mainly focus on the distribution of electronic components. Line cards we deal with include Microchip,ALPS,ROHM,Xilinx,Pulse,ON,Everlight and Freescale. Main products comprise IC,Modules,Potentiometer,IC Socket,Relay,Connector.Our parts cover such applications as commercial,industrial, and automotives areas.

We are looking forward to setting up business relationship with you and hope to provide you with the best service and solution. Let us make a better world for our industry!



## Contact us

Tel: +86-755-8981 8866 Fax: +86-755-8427 6832

Email & Skype: info@chipsmall.com Web: www.chipsmall.com

Address: A1208, Overseas Decoration Building, #122 Zhenhua RD., Futian, Shenzhen, China



# TVS Diodes

Transient Voltage Suppressor Diodes

## ESD102-U2-099EL

2-Line Ultra-low Capacitance ESD / Transient Protection Diodes

ESD102-U2-099EL

## Data Sheet

Revision 1.1, 2013-05-15  
Final

**Edition 2013-05-15**

**Published by  
Infineon Technologies AG  
81726 Munich, Germany**

**© 2013 Infineon Technologies AG  
All Rights Reserved.**

### **Legal Disclaimer**

The information given in this document shall in no event be regarded as a guarantee of conditions or characteristics. With respect to any examples or hints given herein, any typical values stated herein and/or any information regarding the application of the device, Infineon Technologies hereby disclaims any and all warranties and liabilities of any kind, including without limitation, warranties of non-infringement of intellectual property rights of any third party.

### **Information**

For further information on technology, delivery terms and conditions and prices, please contact the nearest Infineon Technologies Office ([www.infineon.com](http://www.infineon.com)).

### **Warnings**

Due to technical requirements, components may contain dangerous substances. For information on the types in question, please contact the nearest Infineon Technologies Office.

Infineon Technologies components may be used in life-support devices or systems only with the express written approval of Infineon Technologies, if a failure of such components can reasonably be expected to cause the failure of that life-support device or system or to affect the safety or effectiveness of that device or system. Life support devices or systems are intended to be implanted in the human body or to support and/or maintain and sustain and/or protect human life. If they fail, it is reasonable to assume that the health of the user or other persons may be endangered.

**Revision History: Revision 1.0, 2013-03-21**

Page or Item	Subjects (major changes since previous revision)
<b>Revision 1.1, 2013-05-15</b>	

**Trademarks of Infineon Technologies AG**

AURIX™, BlueMoon™, COMNEON™, C166™, CROSSAVE™, CanPAK™, CIPOS™, CoolMOS™, CoolSET™, CORECONTROL™, DAVE™, EasyPIM™, EconoBRIDGE™, EconoDUAL™, EconoPACK™, EconoPIM™, EiceDRIVER™, EUPEC™, FCOS™, HITFET™, HybridPACK™, ISOFACE™, I<sup>2</sup>RF™, IsoPACK™, MIPAQ™, ModSTACK™, my-d™, NovalithIC™, OmniTune™, OptiMOS™, ORIGA™, PROFET™, PRO-SIL™, PRIMARION™, PrimePACK™, RASIC™, ReverSave™, SatRIC™, SIEGET™, SINDRION™, SMARTi™, SmartLEWIS™, TEMPFET™, thinQ!™, TriCore™, TRENCHSTOP™, X-GOLD™, XMM™, X-PMU™, XPOSYS™.

**Other Trademarks**

Advance Design System™ (ADS) of Agilent Technologies, AMBA™, ARM™, MULTI-ICE™, PRIMECELL™, REALVIEW™, THUMB™ of ARM Limited, UK. AUTOSAR™ is licensed by AUTOSAR development partnership. Bluetooth™ of Bluetooth SIG Inc. CAT-iq™ of DECT Forum. COLOSSUS™, FirstGPS™ of Trimble Navigation Ltd. EMV™ of EMVCo, LLC (Visa Holdings Inc.). EPCOS™ of Epcos AG. FLEXGO™ of Microsoft Corporation. FlexRay™ is licensed by FlexRay Consortium. HYPERTERMINAL™ of Hilgraeve Incorporated. IEC™ of Commission Electrotechnique Internationale. IrDA™ of Infrared Data Association Corporation. ISO™ of INTERNATIONAL ORGANIZATION FOR STANDARDIZATION. MATLAB™ of MathWorks, Inc. MAXIM™ of Maxim Integrated Products, Inc. MICROTEC™, NUCLEUS™ of Mentor Graphics Corporation. Mifare™ of NXP. MIPI™ of MIPI Alliance, Inc. MIPS™ of MIPS Technologies, Inc., USA. muRata™ of MURATA MANUFACTURING CO., MICROWAVE OFFICE™ (MWO) of Applied Wave Research Inc., OmniVision™ of OmniVision Technologies, Inc. Openwave™ Openwave Systems Inc. RED HAT™ Red Hat, Inc. RFMD™ RF Micro Devices, Inc. SIRIUS™ of Sirius Sattelite Radio Inc. SOLARIS™ of Sun Microsystems, Inc. SPANSION™ of Spansion LLC Ltd. Symbian™ of Symbian Software Limited. TAIYO YUDEN™ of Taiyo Yuden Co. TEAKLITE™ of CEVA, Inc. TEKTRONIX™ of Tektronix Inc. TOKO™ of TOKO KABUSHIKI KAISHA TA. UNIX™ of X/Open Company Limited. VERILOG™, PALLADIUM™ of Cadence Design Systems, Inc. VLYNQ™ of Texas Instruments Incorporated. VXWORKS™, WIND RIVER™ of WIND RIVER SYSTEMS, INC. ZETEX™ of Diodes Zetex Limited.

Last Trademarks Update 2010-06-09

# 1 2-Line Ultra-low Capacitance ESD / Transient Protection Diodes

## 1.1 Features

- ESD / transient protection of high speed data lines exceeding:
  - IEC61000-4-2 (ESD):  $\pm 20$  kV (air / contact)
  - IEC61000-4-4 (EFT):  $\pm 2.5$  kV / 50 A (5/50ns)
  - IEC61000-4-5 (Surge):  $\pm 3$  A (8/20 $\mu$ s)
- Maximum working voltage:  $V_{RWM} = 3.3$  V
- Ultra low capacitance  $C_L = 0.4$  pF (typ.) I/O to GND,  $0.2$  pF (typ.) I/O to I/O
- Very low clamping voltage:  $V_{CL} = 8$  V (typ.) at  $I_{PP} = 16$  A
- Very low dynamic resistance:  $R_{DYN} = 0.19$   $\Omega$  (typ.)
- TSLP-4-10 package with pad pitch 0.4 mm, smallest 2 line package
- Pb-free and halogen free package (RoHS compliant)



## 1.2 Application Examples

- USB 3.0, 10/100/1000 Ethernet, Firewire
- DVI, HDMI, S-ATA, DisplayPort
- Mobile HDMI Link, MDDI, MIPI, etc.

## 1.3 Product Description

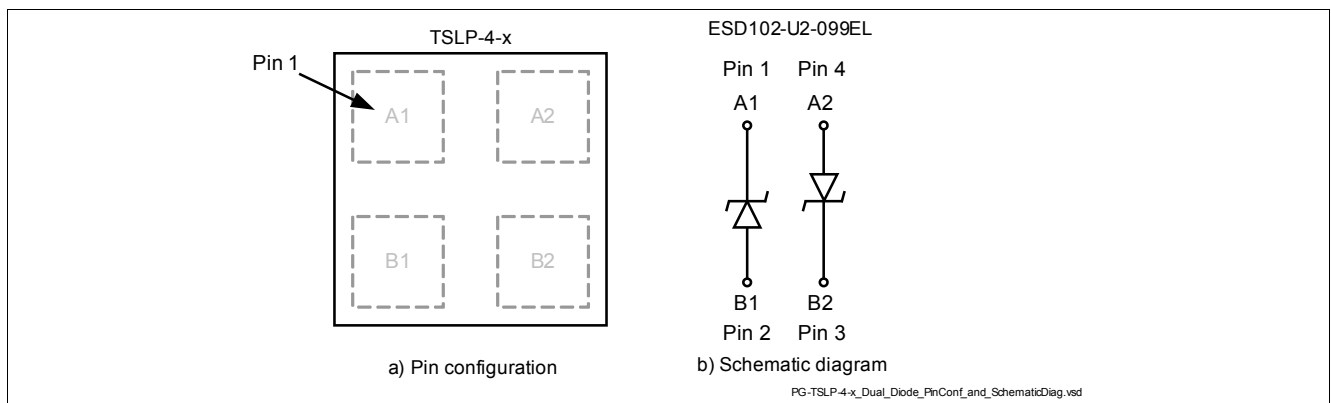

Figure 1 Pin Configuration and Schematic Diagram

Table 1 Ordering Information

Type	Package	Configuration	Marking code
ESD102-U2-099EL	TSLP-4-10	2 Lines anti-parallel, uni-directional	B

## 2 Characteristics

**Table 2 Maximum Rating at  $T_A = 25\text{ }^\circ\text{C}$ , unless otherwise specified**

Parameter	Symbol	Values			Unit
		Min.	Typ.	Max.	
ESD air / contact discharge <sup>1)</sup>	$V_{ESD}$	-20	–	20	kV
Peak pulse current ( $t_p = 8/20\ \mu\text{s}$ ) <sup>2)</sup>	$I_{PP}$	-3	–	3	A
Operating temperature	$T_{OP}$	-40	–	125	$^\circ\text{C}$
Storage temperature	$T_{stg}$	-65	–	150	$^\circ\text{C}$

1)  $V_{ESD}$  according to IEC61000-4-2

2)  $I_{PP}$  according to IEC61000-4-5

### 2.1 Electrical Characteristics at $T_A = 25\text{ }^\circ\text{C}$ , unless otherwise specified

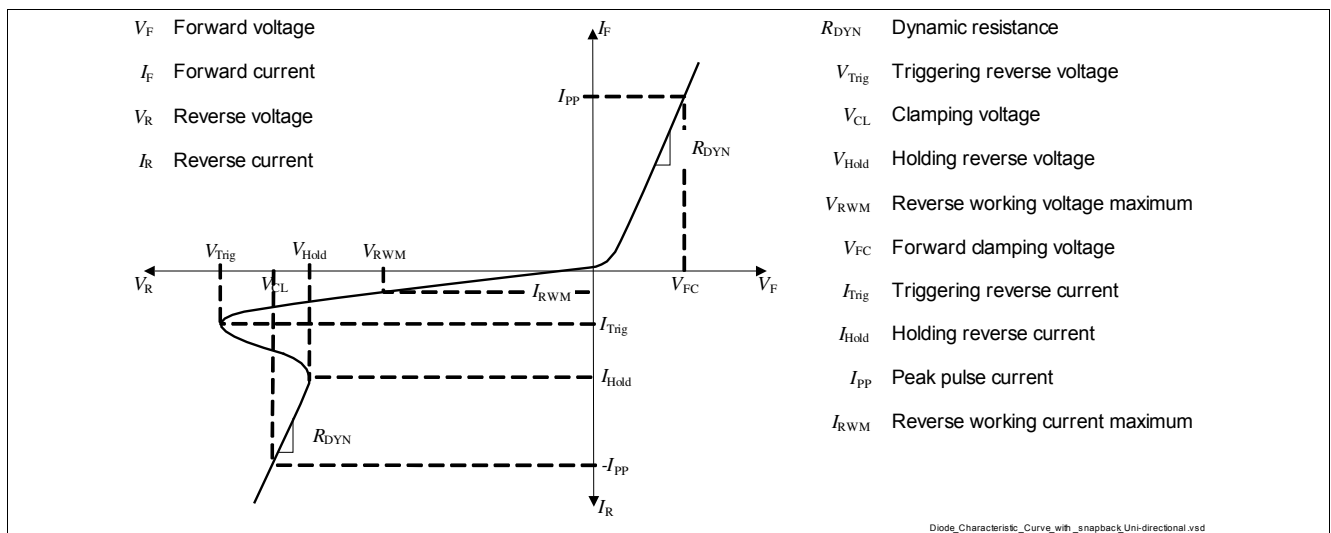

**Figure 2 Definitions of electrical characteristics[1]**

**Table 3 DC Characteristics at  $T_A = 25\text{ }^\circ\text{C}$ , unless otherwise specified**

Parameter	Symbol	Values			Unit	Note / Test Condition
		Min.	Typ.	Max.		
Reverse working voltage	$V_{RWM}$	–	–	3.3	V	I/O to GND
Reverse current	$I_R$	–	1	50	nA	$V_R = 3.3\text{ V}$ , I/O to GND

## Characteristics

**Table 4 RF Characteristics at  $T_A = 25\text{ }^\circ\text{C}$ , unless otherwise specified**

Parameter	Symbol	Values			Unit	Note / Test Condition
		Min.	Typ.	Max.		
Line capacitance <sup>1)</sup>	$C_L$	–	0.4	0.65	pF	$V_R = 0\text{ V}$ , $f = 1\text{ MHz}$ , I/O to GND
		–	0.2	0.35	pF	$V_R = 0\text{ V}$ , $f = 1\text{ MHz}$ , I/O to I/O
Channel capacitance matching between I/O to GND	$\Delta C_{i/o-GND}$	–	0.01	–	pF	$V_R = 0\text{ V}$ , $f = 1\text{ MHz}$ , I/O to GND
Channel capacitance matching between I/O to I/O	$\Delta C_{i/o-i/o}$	–	0.005	–	pF	$V_R = 0\text{ V}$ , $f = 1\text{ MHz}$ , I/O to I/O

1) Total capacitance line to ground

**Table 5 ESD Characteristics at  $T_A = 25\text{ }^\circ\text{C}$ , unless otherwise specified**

Parameter	Symbol	Values			Unit	Note / Test Condition
		Min.	Typ.	Max.		
Clamping voltage <sup>1)</sup> [2]	$V_{CL}$	–	8	–	V	$I_{TLP} = 16\text{ A}$ , from I/O to GND
		–	11	–	V	$I_{TLP} = 30\text{ A}$ , from I/O to GND
Forward clamping voltage <sup>1)</sup> [2]	$V_{FC}$	–	6	–	V	$I_{TLP} = 16\text{ A}$ , from GND to I/O
		–	9	–	V	$I_{TLP} = 30\text{ A}$ , from GND to I/O
Dynamic resistance <sup>1)</sup> [2]	$R_{DYN}$	–	0.19	–	$\Omega$	I/O to GND
		–	0.23	–	$\Omega$	GND to I/O

 1) Please refer to Application Note AN210. TLP parameter:  $Z_0 = 50\text{ }\Omega$ ,  $t_p = 100\text{ ns}$ ,  $t_r = 300\text{ ps}$ , averaging window:  $t_1 = 30\text{ ns}$  to  $t_2 = 60\text{ ns}$ , extraction of dynamic resistance using least squares fit of TLP characteristic between  $I_{TLP1} = 10\text{ A}$  and  $I_{TLP2} = 40\text{ A}$ .

Typical Characteristics at  $T_A = 25\text{ }^\circ\text{C}$ , unless otherwise specified

### 3 Typical Characteristics at $T_A = 25\text{ }^\circ\text{C}$ , unless otherwise specified

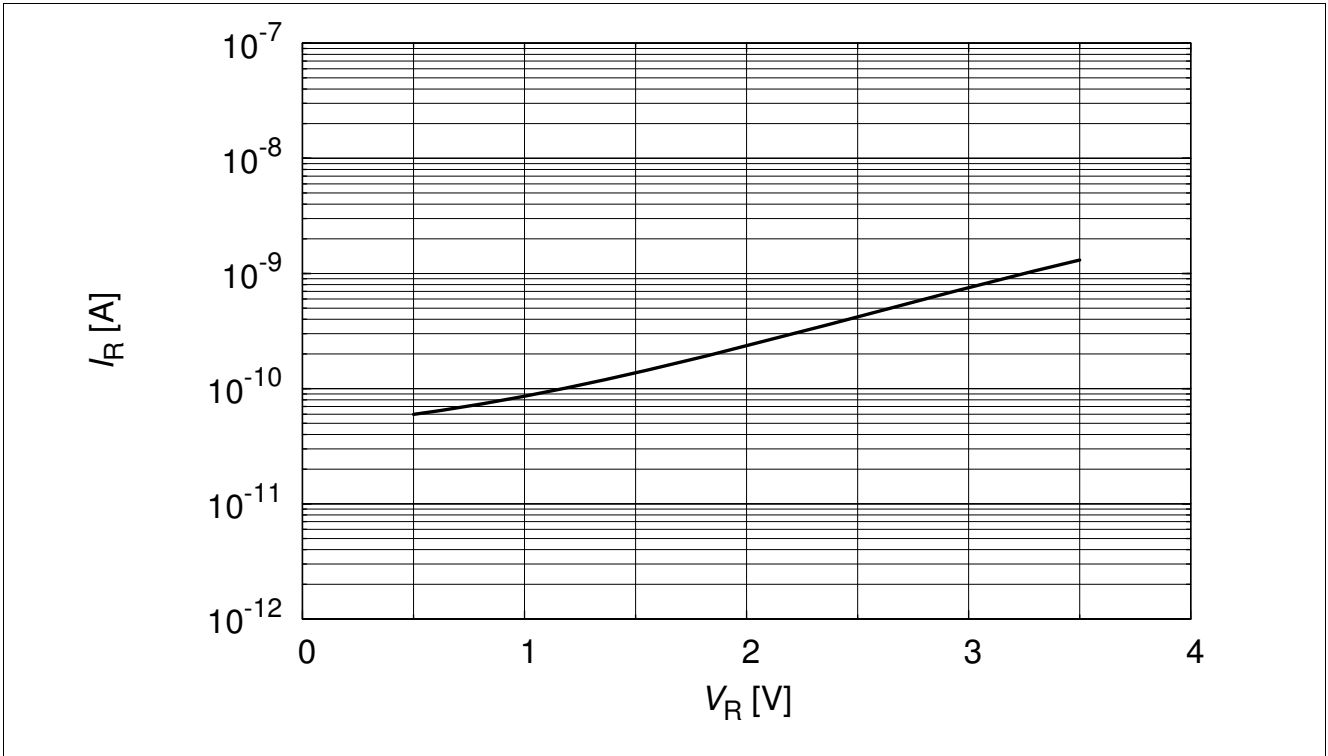

Figure 3 Reverse current,  $I_R = (V_R)$

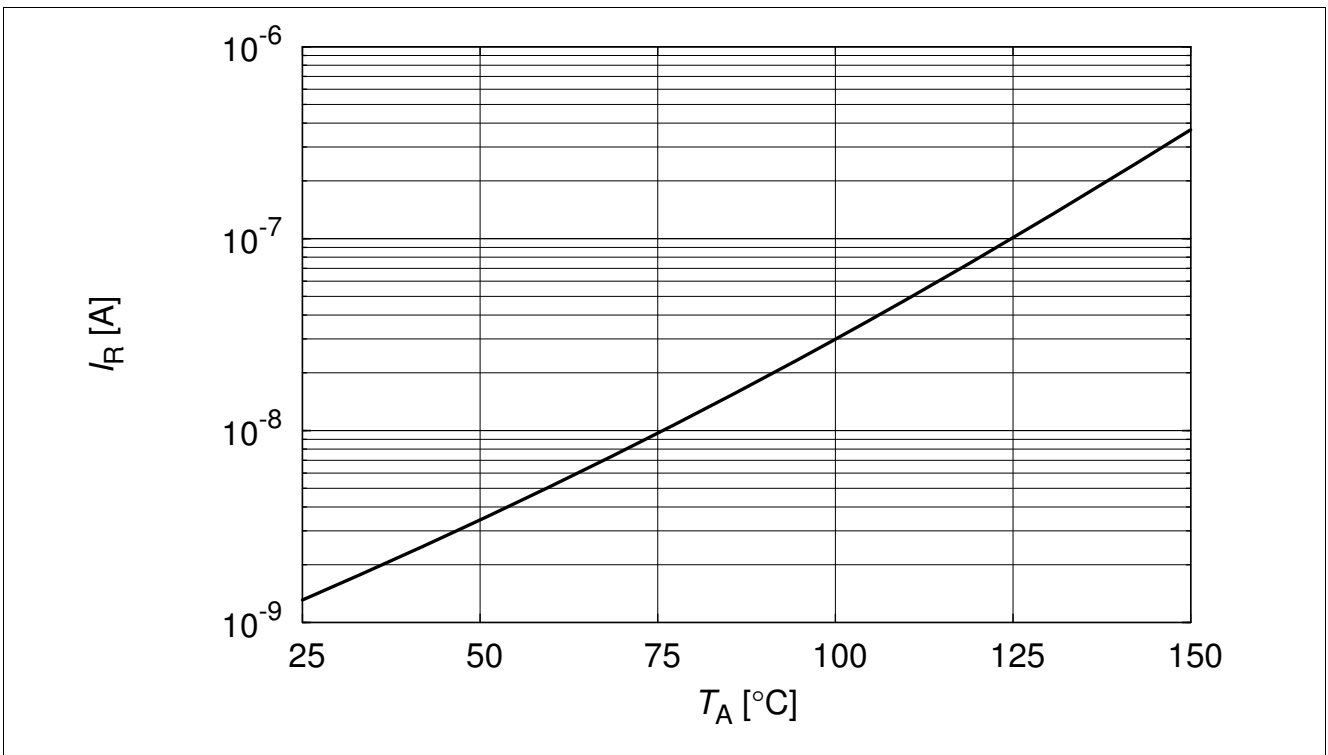

Figure 4 Reverse current:  $I_R = f(T_A)$ ,  $V_R = 3.3\text{ V}$



Typical Characteristics at  $T_A = 25\text{ }^\circ\text{C}$ , unless otherwise specified

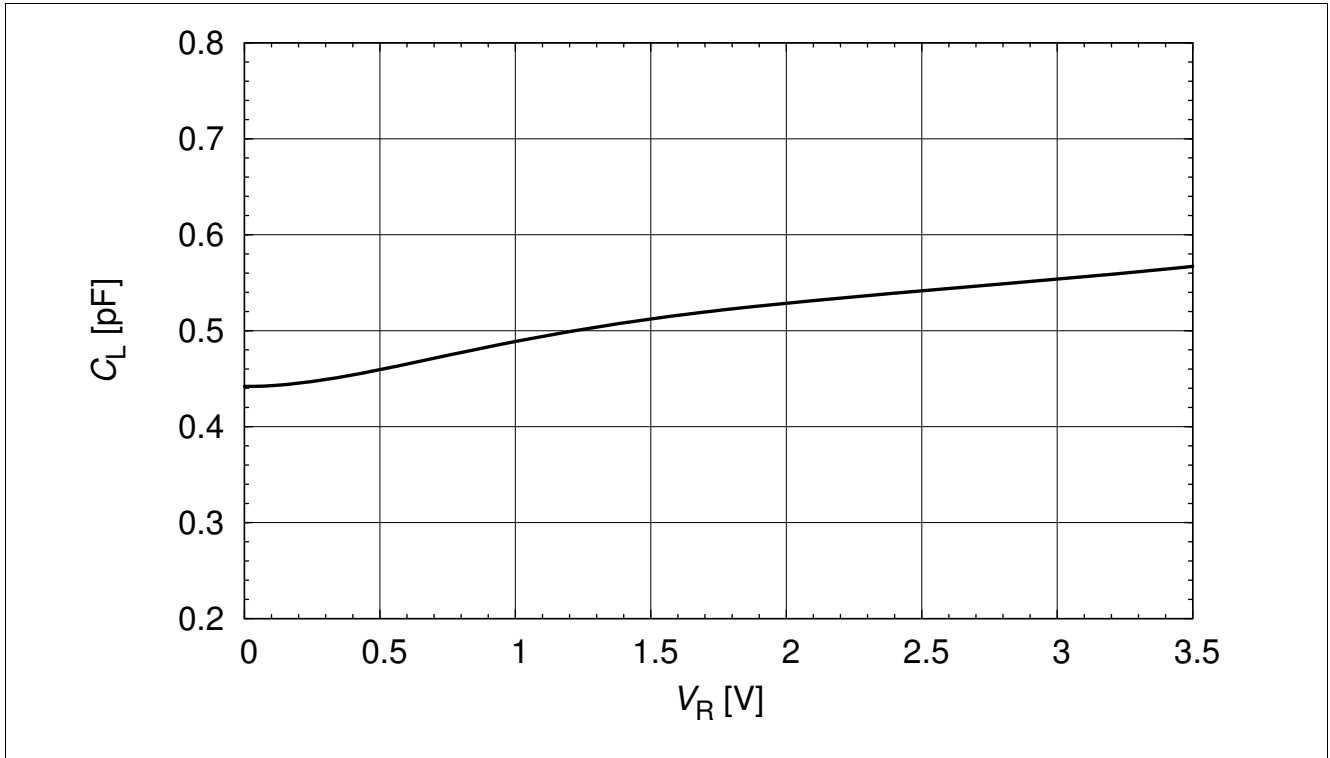
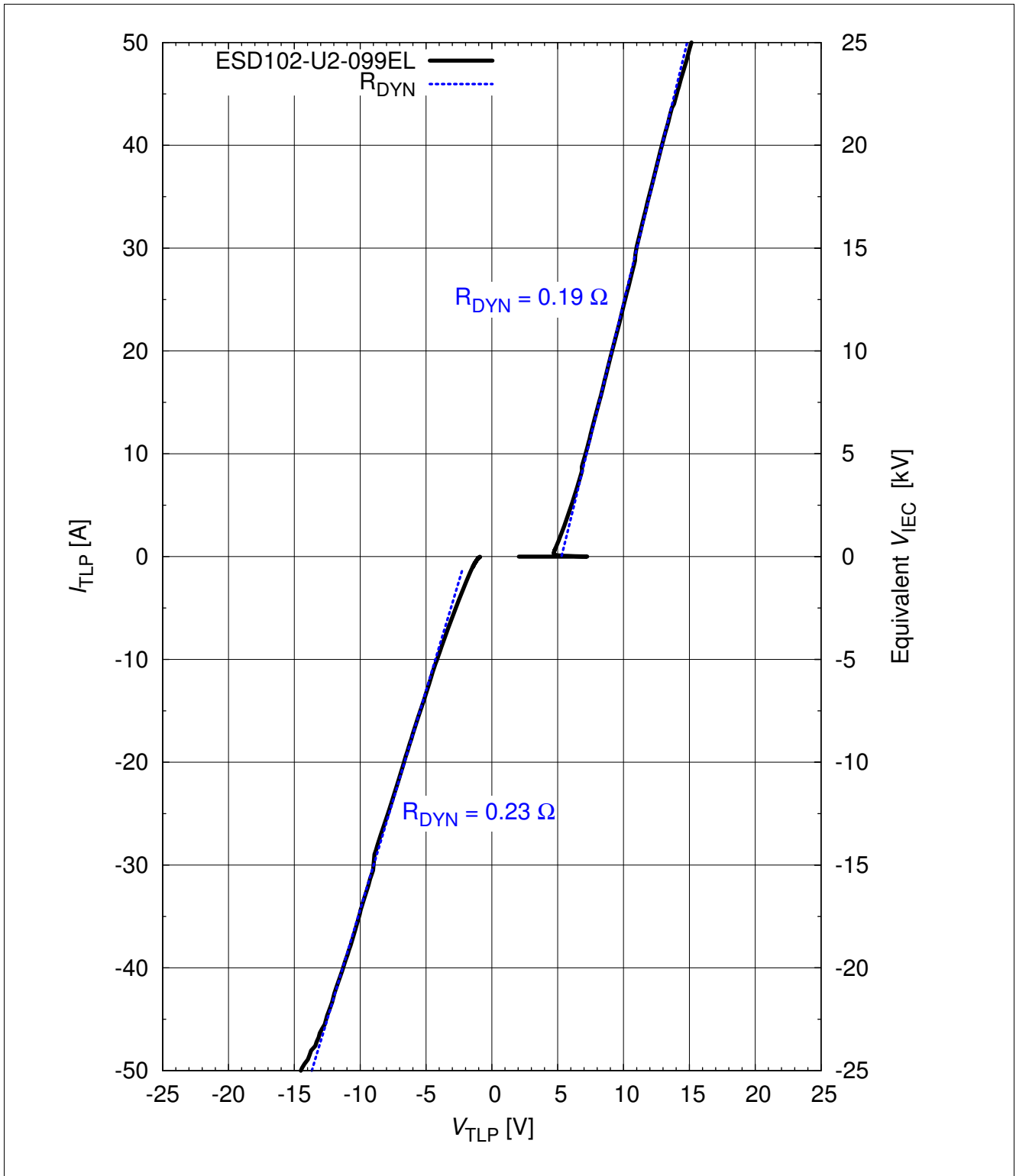

Figure 5 Line capacitance:  $C_L = f(V_R)$ ,  $f = 1\text{MHz}$ , from I/O to GND

Typical Characteristics at  $T_A = 25\text{ }^\circ\text{C}$ , unless otherwise specified



**Figure 6 Clamping voltage  $V_{TLP} = f(I_{TLP})$ [2]**

Note: TLP parameter:  $Z_0 = 50\ \Omega$ ,  $t_p = 100\text{ ns}$ ,  $t_r = 300\text{ ps}$ , averaging window:  $t_1 = 30\text{ ns}$  to  $t_2 = 60\text{ ns}$ , extraction of dynamic resistance using least squares fit of TLP characteristic between  $I_{TLP1} = 10\text{ A}$  and  $I_{TLP2} = 40\text{ A}$ . The equivalent stress level  $V_{IEC}$  according IEC 61000-4-2 ( $R = 330\ \Omega$ ,  $C = 150\text{ pF}$ ) is calculated at the broad peak of the IEC waveform at  $t = 30\text{ ns}$  with  $2\text{ A/kV}$

Typical Characteristics at  $T_A = 25\text{ }^\circ\text{C}$ , unless otherwise specified

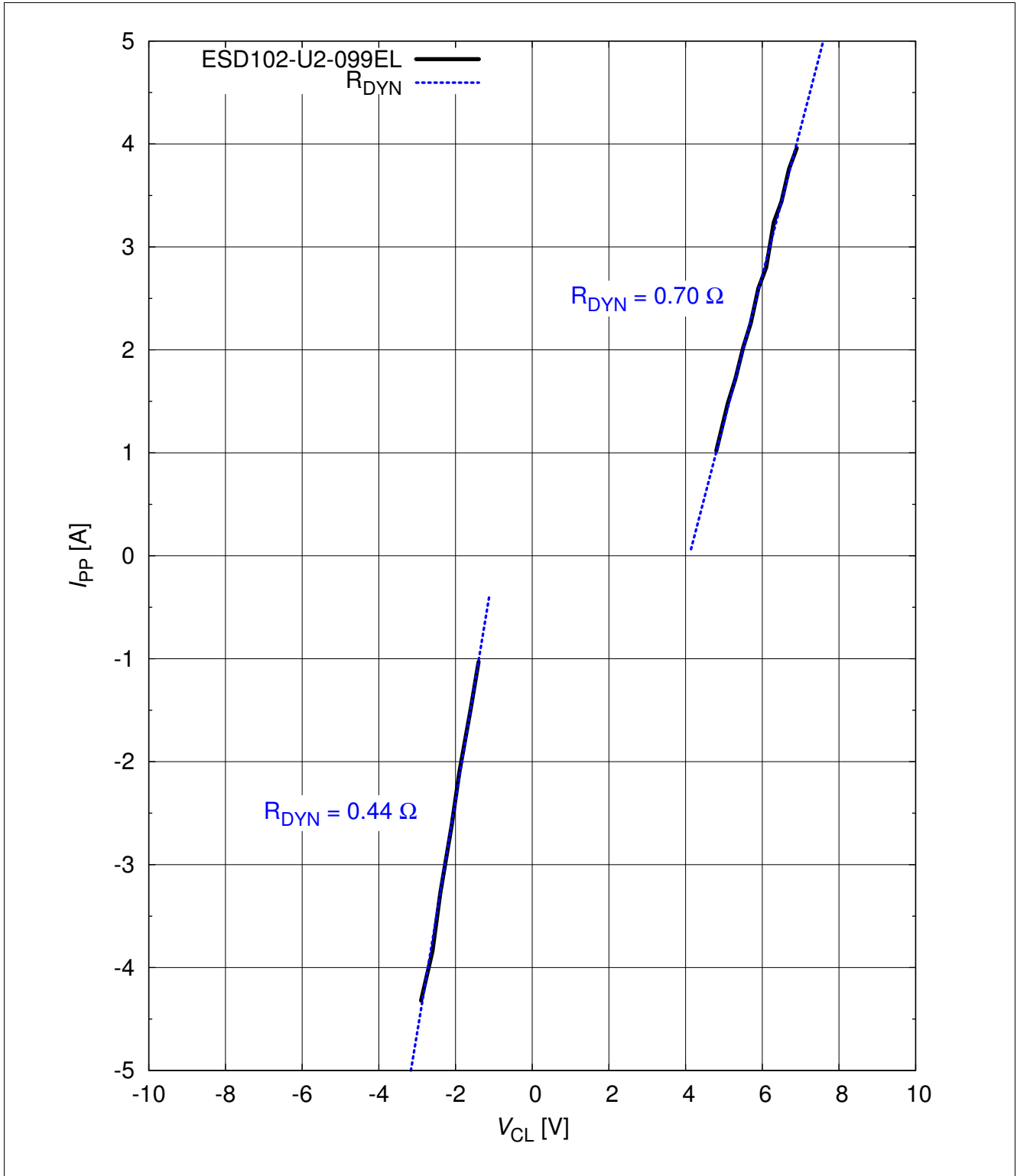

Figure 7 Pulse current (IEC61000-4-5) versus clamping voltage:  $I_{PP} = f(V_{CL})$

Typical Characteristics at  $T_A = 25\text{ }^\circ\text{C}$ , unless otherwise specified

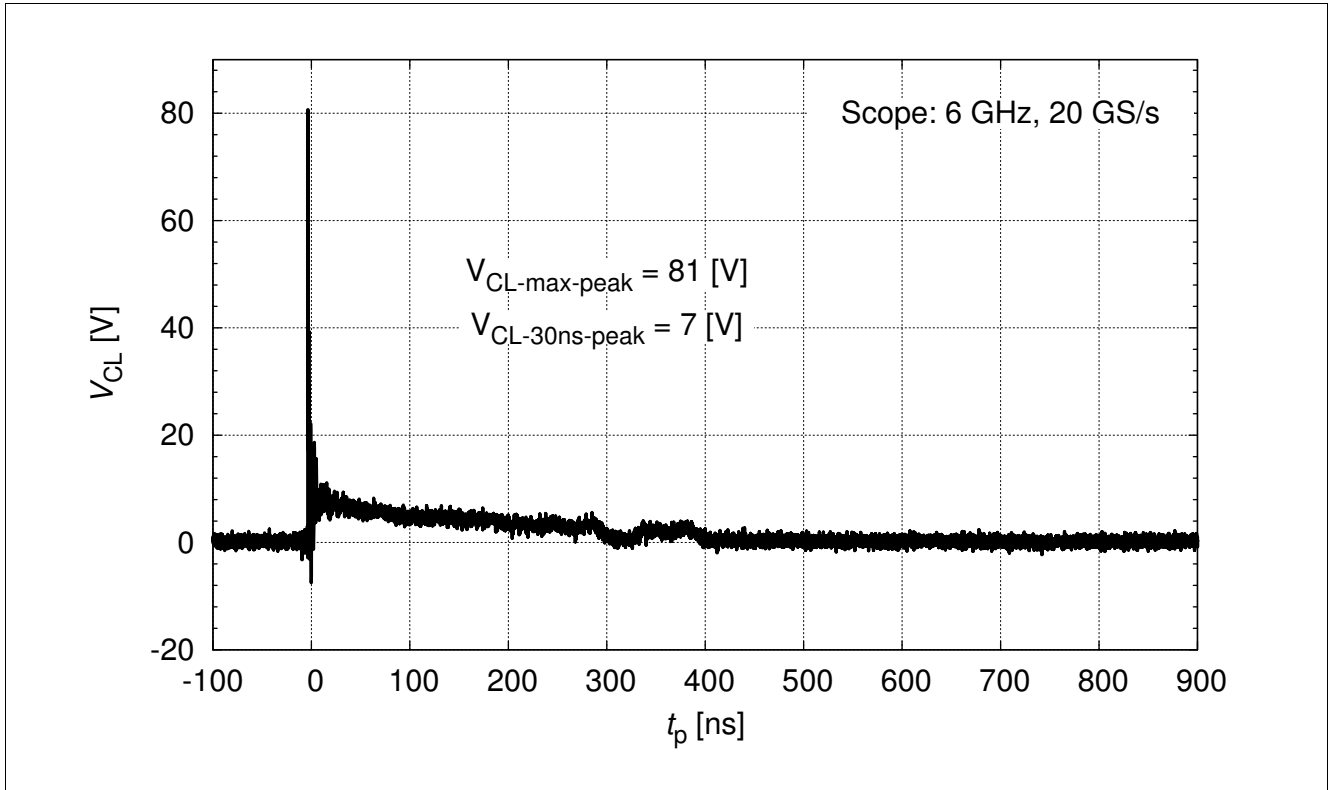

Figure 8 IEC61000-4-2  $V_{CL} = f(t)$ , 8 kV positive pulse from pin 1 to pin 2

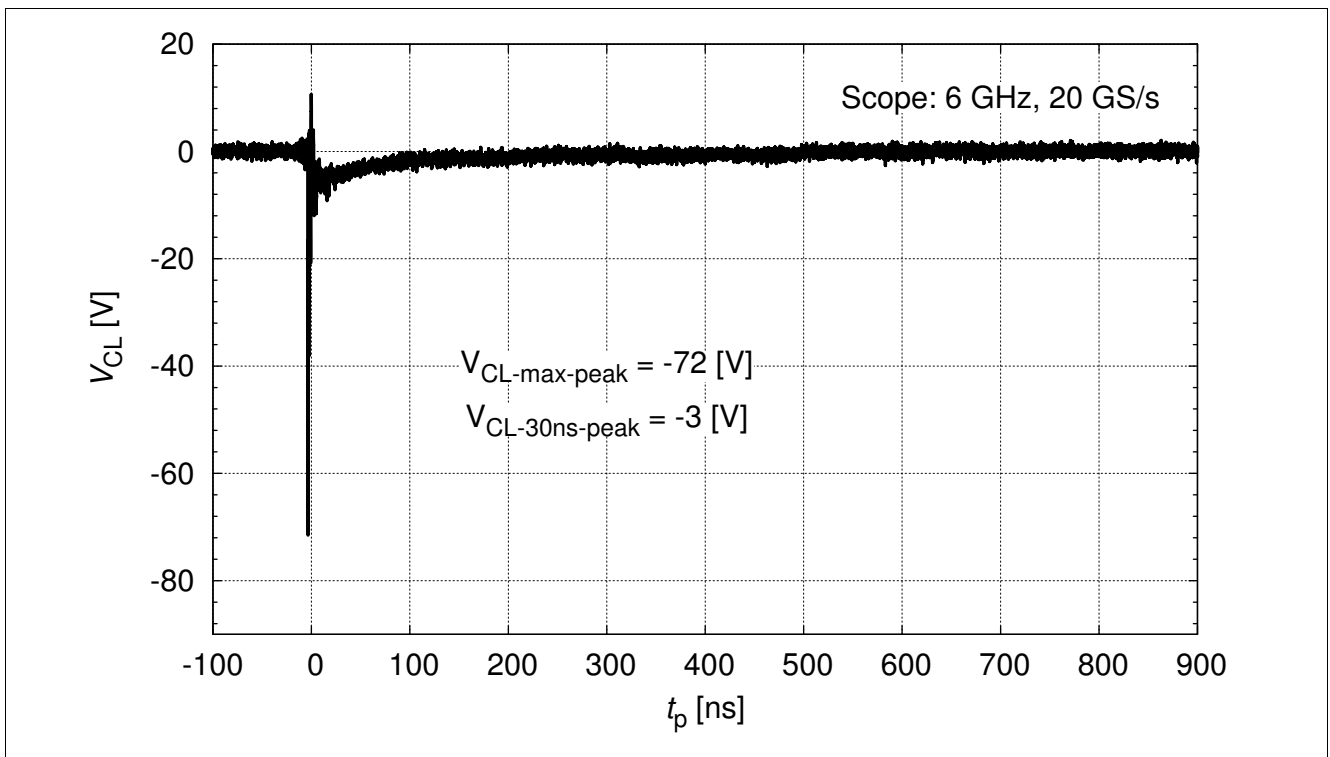

Figure 9 IEC61000-4-2  $V_{CL} = f(t)$ , 8 kV negative pulse from pin 1 to pin 2

Typical Characteristics at  $T_A = 25\text{ }^\circ\text{C}$ , unless otherwise specified

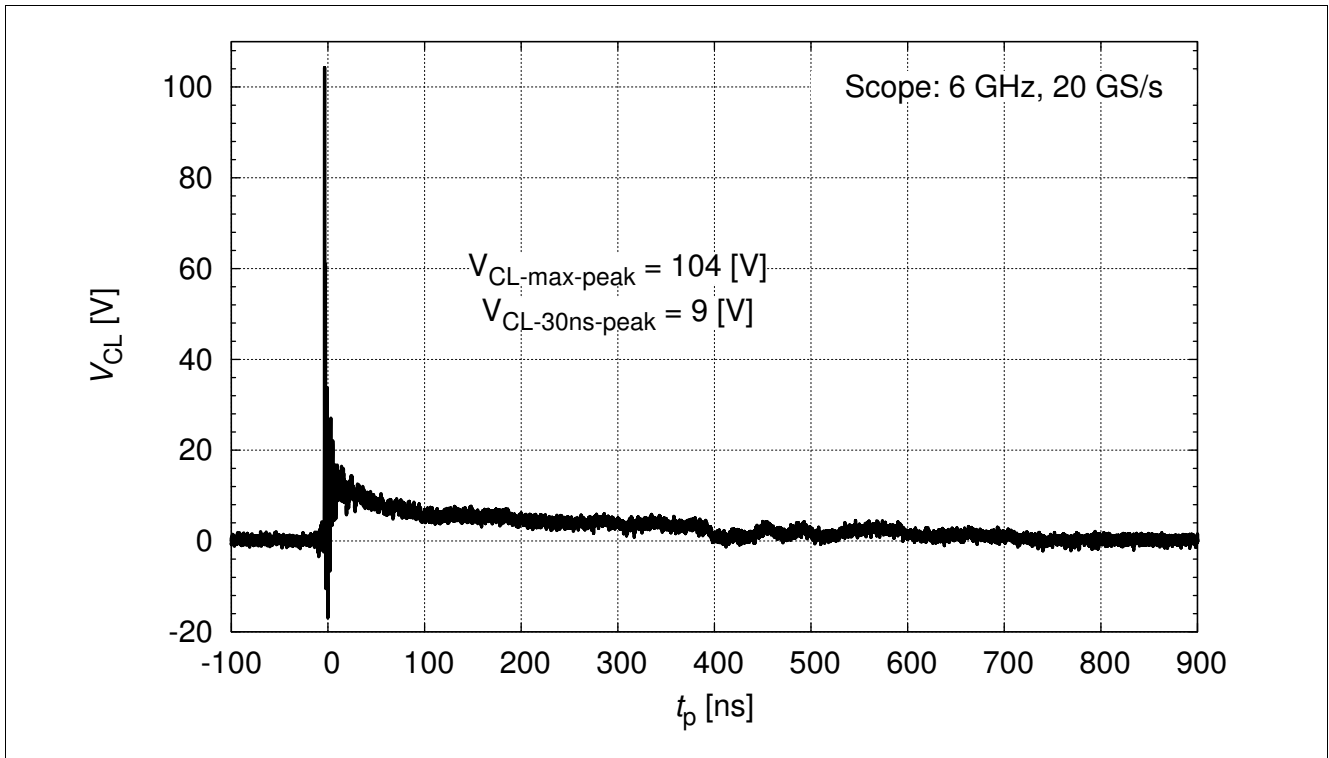

Figure 10 IEC61000-4-2  $V_{CL} = f(t)$ , 15 kV positive pulse from pin 1 to pin 2

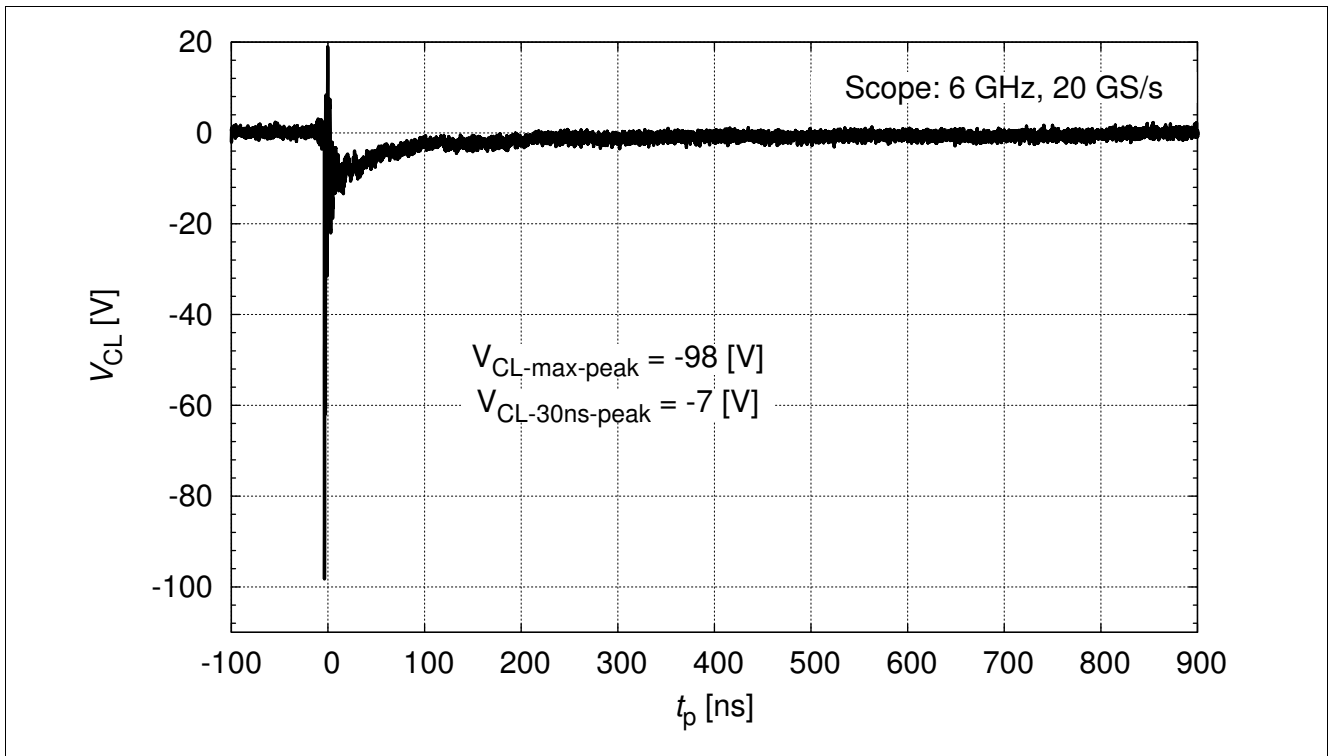

Figure 11 IEC61000-4-2  $V_{CL} = f(t)$ , 15 kV negative pulse from pin 1 to pin 2

## 4 Package Information

### 4.1 TSLP-4-10 (mm)

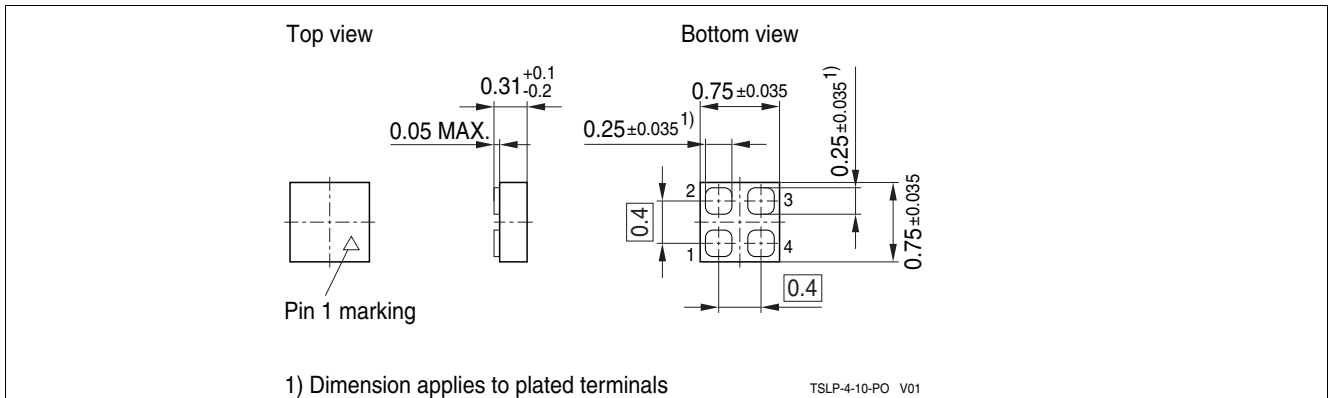

Figure 12 TSLP-4-10: Package outline (dimension in mm)

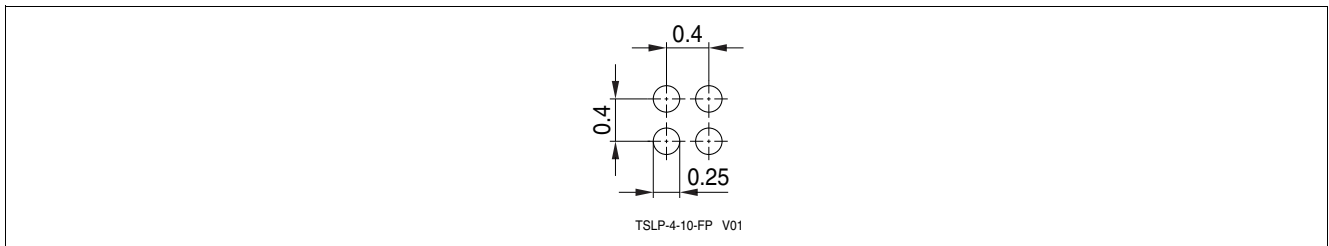

Figure 13 TSLP-4-10: Footprint (dimension in mm)

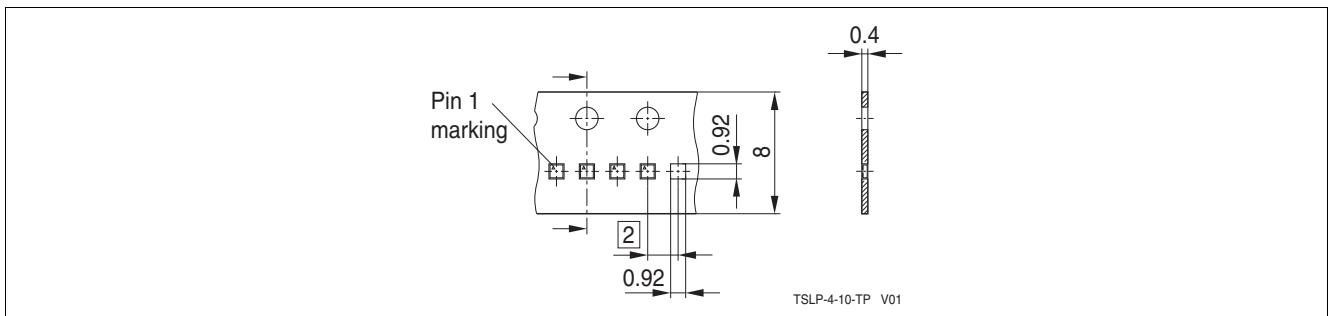

Figure 14 TSLP-4-10: Packing dimension in mm)

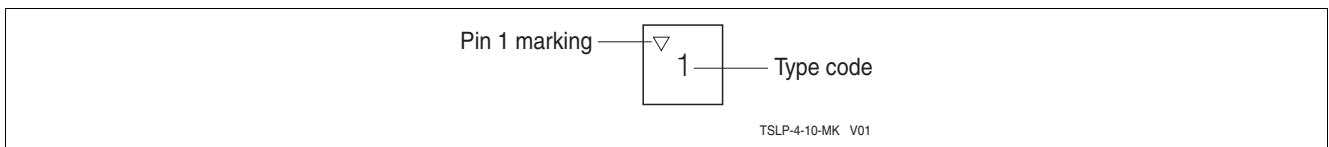

Figure 15 TSLP-4-10: Marking (example)

**References**

- [1] **On-chip ESD protection for integrated circuits**, Albert Z. H. Wang, ISBN:0-7923-7647-1
- [2] Infineon Technologie AG - **Application Note AN210**: Effective ESD Protection Design at System Level Using VF-TLP Characterization Methodology
- [3] Infineon Technologie AG - **Application Note AN240**: Effective ESD Protection for USB3.0, combined with perfect Signal Integrity.

[www.infineon.com](http://www.infineon.com)

Published by Infineon Technologies AG