



Chipsmall Limited consists of a professional team with an average of over 10 year of expertise in the distribution of electronic components. Based in Hongkong, we have already established firm and mutual-benefit business relationships with customers from,Europe,America and south Asia,supplying obsolete and hard-to-find components to meet their specific needs.

With the principle of “Quality Parts,Customers Priority,Honest Operation,and Considerate Service”,our business mainly focus on the distribution of electronic components. Line cards we deal with include Microchip,ALPS,ROHM,Xilinx,Pulse,ON,Everlight and Freescale. Main products comprise IC,Modules,Potentiometer,IC Socket,Relay,Connector.Our parts cover such applications as commercial,industrial, and automotives areas.

We are looking forward to setting up business relationship with you and hope to provide you with the best service and solution. Let us make a better world for our industry!



Contact us

Tel: +86-755-8981 8866 Fax: +86-755-8427 6832

Email & Skype: info@chipsmall.com Web: www.chipsmall.com

Address: A1208, Overseas Decoration Building, #122 Zhenhua RD., Futian, Shenzhen, China



TVS Diode

Transient Voltage Suppressor Diodes

ESD3V3S1B Series

Ultra Low Clamping Bi-directional ESD / Transient Protection Diode

ESD3V3S1B-02LRH
ESD3V3S1B-02LS

Data Sheet

Revision 1.1, 2011-11-28
Final

Industrial and Multi-Market

Edition 2011-11-28

**Published by
Infineon Technologies AG
81726 Munich, Germany**

**© 2011 Infineon Technologies AG
All Rights Reserved.**

Legal Disclaimer

The information given in this document shall in no event be regarded as a guarantee of conditions or characteristics. With respect to any examples or hints given herein, any typical values stated herein and/or any information regarding the application of the device, Infineon Technologies hereby disclaims any and all warranties and liabilities of any kind, including without limitation, warranties of non-infringement of intellectual property rights of any third party.

Information

For further information on technology, delivery terms and conditions and prices, please contact the nearest Infineon Technologies Office (www.infineon.com).

Warnings

Due to technical requirements, components may contain dangerous substances. For information on the types in question, please contact the nearest Infineon Technologies Office.

Infineon Technologies components may be used in life-support devices or systems only with the express written approval of Infineon Technologies, if a failure of such components can reasonably be expected to cause the failure of that life-support device or system or to affect the safety or effectiveness of that device or system. Life support devices or systems are intended to be implanted in the human body or to support and/or maintain and sustain and/or protect human life. If they fail, it is reasonable to assume that the health of the user or other persons may be endangered.

Revision History

Page or Item	Subjects (major changes since previous revision)
Revision 1.1, 2011-11-28	
Revision 1.1; 2011-11-28	Features 1.1; Table 3-1; Table 3-3; Table 3-4

Trademarks of Infineon Technologies AG

AURIX™, BlueMoon™, C166™, CanPAK™, CIPOS™, CIPURSE™, COMNEON™, EconoPACK™, CoolMOS™, CoolSET™, CORECONTROL™, CROSSAVE™, DAVE™, EasyPIM™, EconoBRIDGE™, EconoDUAL™, EconoPIM™, EiceDRIVER™, eupec™, FCOS™, HITFET™, HybridPACK™, I²RF™, ISOFACE™, IsoPACK™, MIPAQ™, ModSTACK™, my-d™, NovalithIC™, OmniTune™, OptiMOS™, ORIGA™, PRIMARION™, PrimePACK™, PrimeSTACK™, PRO-SIL™, PROFET™, RASIC™, ReverSave™, SatRIC™, SIEGET™, SINDRION™, SIPMOS™, SMARTi™, SmartLEWIS™, SOLID FLASH™, TEMPFET™, thinQ!™, TRENCHSTOP™, TriCore™, X-GOLD™, X-PMU™, XMM™, XPOSYS™.

Other Trademarks

Advance Design System™ (ADS) of Agilent Technologies, AMBA™, ARM™, MULTI-ICE™, KEIL™, PRIMECELL™, REALVIEW™, THUMB™, μVision™ of ARM Limited, UK. AUTOSAR™ is licensed by AUTOSAR development partnership. Bluetooth™ of Bluetooth SIG Inc. CAT-iq™ of DECT Forum. COLOSSUS™, FirstGPS™ of Trimble Navigation Ltd. EMV™ of EMVCo, LLC (Visa Holdings Inc.). EPCOS™ of Epcos AG. FLEXGO™ of Microsoft Corporation. FlexRay™ is licensed by FlexRay Consortium. HYPERTERMINAL™ of Hilgraeve Incorporated. IEC™ of Commission Electrotechnique Internationale. IrDA™ of Infrared Data Association Corporation. ISO™ of INTERNATIONAL ORGANIZATION FOR STANDARDIZATION. MATLAB™ of MathWorks, Inc. MAXIM™ of Maxim Integrated Products, Inc. MICROTEC™, NUCLEUS™ of Mentor Graphics Corporation. Mifare™ of NXP. MIPI™ of MIPI Alliance, Inc. MIPS™ of MIPS Technologies, Inc., USA. muRata™ of MURATA MANUFACTURING CO., MICROWAVE OFFICE™ (MWO) of Applied Wave Research Inc., OmniVision™ of OmniVision Technologies, Inc. Openwave™ Openwave Systems Inc. RED HAT™ Red Hat, Inc. RFMD™ RF Micro Devices, Inc. SIRIUS™ of Sirius Satellite Radio Inc. SOLARIS™ of Sun Microsystems, Inc. SPANSION™ of Spansion LLC Ltd. Symbian™ of Symbian Software Limited. TAIYO YUDEN™ of Taiyo Yuden Co. TEAKLITE™ of CEVA, Inc. TEKTRONIX™ of Tektronix Inc. TOKO™ of TOKO KABUSHIKI KAISHA TA. UNIX™ of X/Open Company Limited. VERILOG™, PALLADIUM™ of Cadence Design Systems, Inc. VLYNQ™ of Texas Instruments Incorporated. VXWORKS™, WIND RIVER™ of WIND RIVER SYSTEMS, INC. ZETEX™ of Diodes Zetex Limited.

Last Trademarks Update 2010-10-26

Table of Contents

	Table of Contents	4
	List of Figures	5
	List of Tables	6
1	Ultra Low Clamping Bi-directional ESD / Transient Protection Diode	7
1.1	Features	7
1.2	Application Examples	7
2	Product Description	7
3	Characteristics	8
3.1	Electrical Characteristics at $T_A = 25\text{ °C}$, unless otherwise specified	8
3.2	Typical Characteristics at $T_A = 25\text{ °C}$, unless otherwise specified	9
4	Application Information	14
5	Ordering Information Scheme (Examples)	15
6	Package Information	16
6.1	PG-TSLP-2-17 (mm) [2]	16
6.2	PG-TSSLP-2-1 (mm) [2]	17
	References	18
	Terminology	19
	Predefined Names	20

List of Figures

Figure 2-1	Pin Configuration and Schematic Diagram	7
Figure 3-1	Definitions of electrical characteristics	8
Figure 3-2	Reverse current: $I_R = f(V_R)$	9
Figure 3-3	Reverse current: $I_R = f(T_A)$, $V_R = 3.3 V$	10
Figure 3-4	Line capacitance: $C_L = f(V_R)$, $f = 1MHz$	10
Figure 3-5	Clamping voltage (TLP): $I_{TLP} = f(V_{TLP})$, from pin 1 to pin 2 [1]	11
Figure 3-6	Clamping voltage (TLP): $I_{TLP} = f(V_{TLP})$, from pin 2 to pin 1 [1]	11
Figure 3-7	IEC61000-4-2 : $V_{CL} = f(t)$, 8 kV positive pulse from pin 1 to pin 2	12
Figure 3-8	IEC61000-4-2 : $V_{CL} = f(t)$, 8 kV negative pulse from pin 1 to pin 2	12
Figure 3-9	IEC61000-4-2 : $V_{CL} = f(t)$, 15 kV positive pulse from pin 1 to pin 2	13
Figure 3-10	IEC61000-4-2 : $V_{CL} = f(t)$, 15 kV negative pulse from pin 1 to pin 2	13
Figure 4-1	Single line, bi-directional ESD / Transient protection	14
Figure 5-1	Ordering information scheme	15
Figure 6-1	PG-TSLP-2-17: Package overview	16
Figure 6-2	PG-TSLP-2-17: Footprint	16
Figure 6-3	PG-TSLP-2-17: Packing	16
Figure 6-4	PG-TSLP-2-17: Marking (example)	16
Figure 6-5	PG-TSSLP-2-1: Package overview	17
Figure 6-6	PG-TSSLP-2-1: Footprint	17
Figure 6-7	PG-TSSLP-2-1: Packing	17
Figure 6-8	PG-TSSLP-2-1: Marking (example)	17

List of Tables

Table 2-1	Ordering Information	7
Table 3-1	Maximum Ratings at $T_A = 25\text{ }^\circ\text{C}$, unless otherwise specified	8
Table 3-2	DC Characteristics at $T_A = 25\text{ }^\circ\text{C}$, unless otherwise specified	8
Table 3-3	RF Characteristics at $T_A = 25\text{ }^\circ\text{C}$, unless otherwise specified	9
Table 3-4	ESD Characteristics at $T_A = 25\text{ }^\circ\text{C}$, unless otherwise specified	9

1 Ultra Low Clamping Bi-directional ESD / Transient Protection Diode

1.1 Features

- ESD / transient protection of signal lines in low voltage applications according to:
 - IEC61000-4-2 (ESD): ± 30 kV (contact)
 - IEC61000-4-4 (EFT): 40 A (5/50 ns)
 - IEC61000-4-5 (surge): 8 A (8/20 μ s)
- Bi-directional, symmetrical working voltage up to $V_{RWM} = \pm 3.3$ V
- Ultra low clamping voltage $V_{CL} = 7$ V typ. @ $I_{PP} = 16$ A (TLP)
- Ultra low dynamic resistance $R_{DYN} = 0.13 \Omega$ typ.
- Smallest form factor: $0.62 \times 0.32 \times 0.31$ mm³
- Pb-free (RoHS compliant) and halogen free package



1.2 Application Examples

- Audio Line, Speaker, Headset, Microphone Protection
- Human Interface Devices (Keyboard, Touchpad, Buttons)

2 Product Description

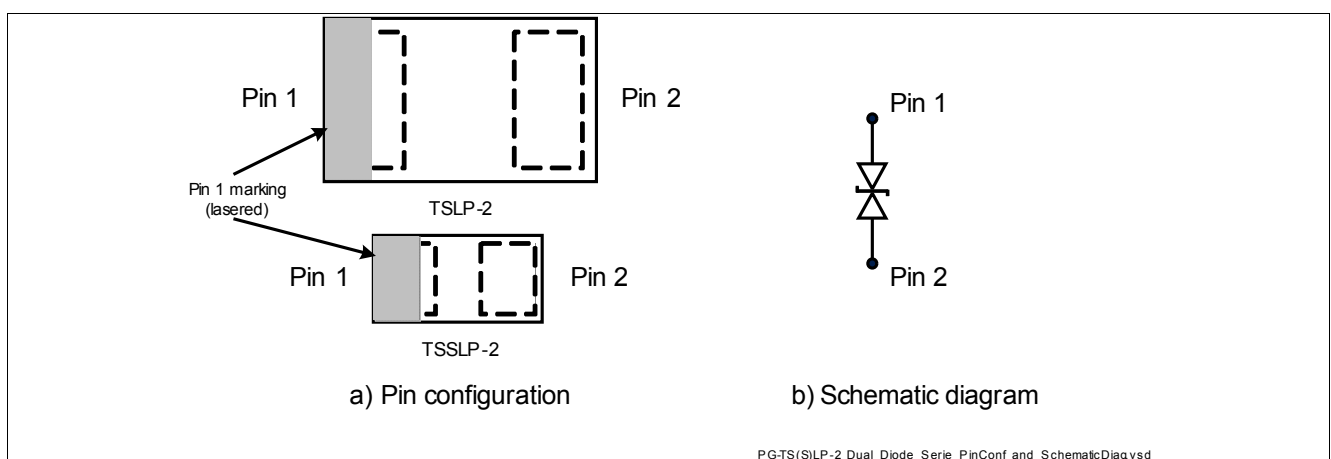

Figure 2-1 Pin Configuration and Schematic Diagram

Table 2-1 Ordering Information

Type	Package	Configuration	Marking code
ESD3V3S1B-02LRH	PG-TSLP-2-17	1 line, bi-directional	Y
ESD3V3S1B-02LS	PG-TSSLP-2-1	1 line, bi-directional	Y

3 Characteristics

Table 3-1 Maximum Ratings at $T_A = 25\text{ }^\circ\text{C}$, unless otherwise specified

Parameter	Symbol	Values			Unit
		Min.	Typ.	Max.	
ESD contact discharge ¹⁾	V_{ESD}	–	–	30	kV
Peak pulse current ($t_p = 8/20\text{ }\mu\text{s}$) ²⁾	I_{PP}	–	–	8	A
Operating temperature range	T_{OP}	-40	–	125	$^\circ\text{C}$
Storage temperature	T_{stg}	-65	–	150	$^\circ\text{C}$

1) V_{ESD} according to IEC61000-4-2

2) I_{PP} according to IEC61000-4-5

3.1 Electrical Characteristics at $T_A = 25\text{ }^\circ\text{C}$, unless otherwise specified

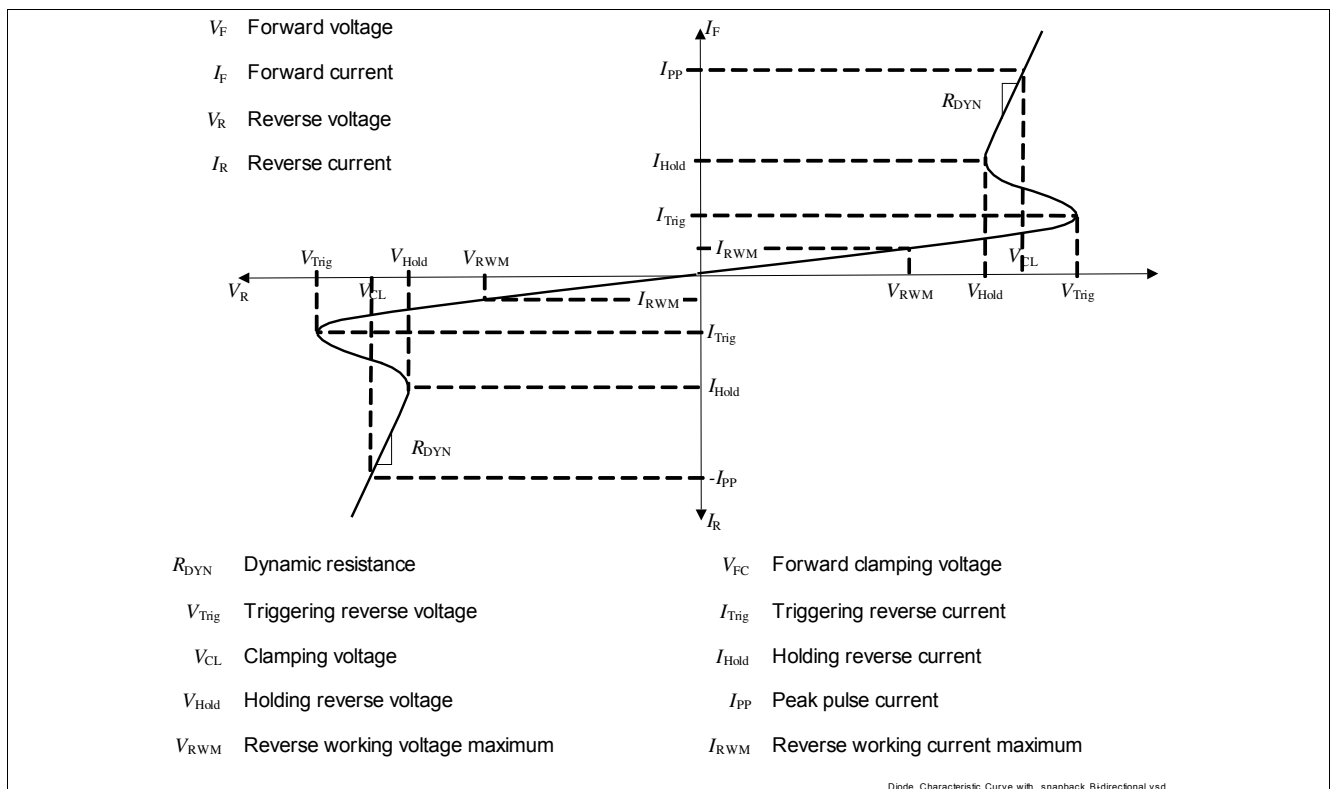

Figure 3-1 Definitions of electrical characteristics

Table 3-2 DC Characteristics at $T_A = 25\text{ }^\circ\text{C}$, unless otherwise specified

Parameter	Symbol	Values			Unit	Note / Test Condition
		Min.	Typ.	Max.		
Reverse working voltage	V_{RWM}	-3.3	–	3.3	V	
Reverse current	I_R	–	–	50	nA	$V_R = 3.3\text{ V}$

Table 3-3 RF Characteristics at $T_A = 25\text{ }^\circ\text{C}$, unless otherwise specified

Parameter	Symbol	Values			Unit	Note / Test Condition
		Min.	Typ.	Max.		
Line capacitance	C_L	–	14	20	pF	$V_R = 0\text{ V}, f = 1\text{ MHz}$

Table 3-4 ESD Characteristics at $T_A = 25\text{ }^\circ\text{C}$, unless otherwise specified

Parameter	Symbol	Values			Unit	Note / Test Condition
		Min.	Typ.	Max.		
Clamping voltage ¹⁾	V_{CL}	–	7	–	V	$I_{PP} = 16\text{ A}, t_p = 100\text{ ns}$
		–	9	–	V	$I_{PP} = 30\text{ A}, t_p = 100\text{ ns}$
Clamping voltage ²⁾	V_{CL}	–	4.5	–	V	$I_{PP} = 1\text{ A}, t_p = 8/20\text{ }\mu\text{s}$
		–	6.8	–	V	$I_{PP} = 8\text{ A}, t_p = 8/20\text{ }\mu\text{s}$
Dynamic resistance ¹⁾	R_{DYN}	–	0.13	–	Ω	

1) Please refer to Application Note AN210 [1]. TLP parameter: $Z_0 = 50\text{ }\Omega$, $t_p = 100\text{ ns}$, $t_r = 300\text{ ps}$, averaging window: $t_1 = 30\text{ ns}$ to $t_2 = 60\text{ ns}$, extraction of dynamic resistance using least squares fit of TLP characteristics between $I_{PP1} = 10\text{ A}$ and $I_{PP2} = 40\text{ A}$.

2) I_{PP} according to IEC61000-4-5

3.2 Typical Characteristics at $T_A = 25\text{ }^\circ\text{C}$, unless otherwise specified

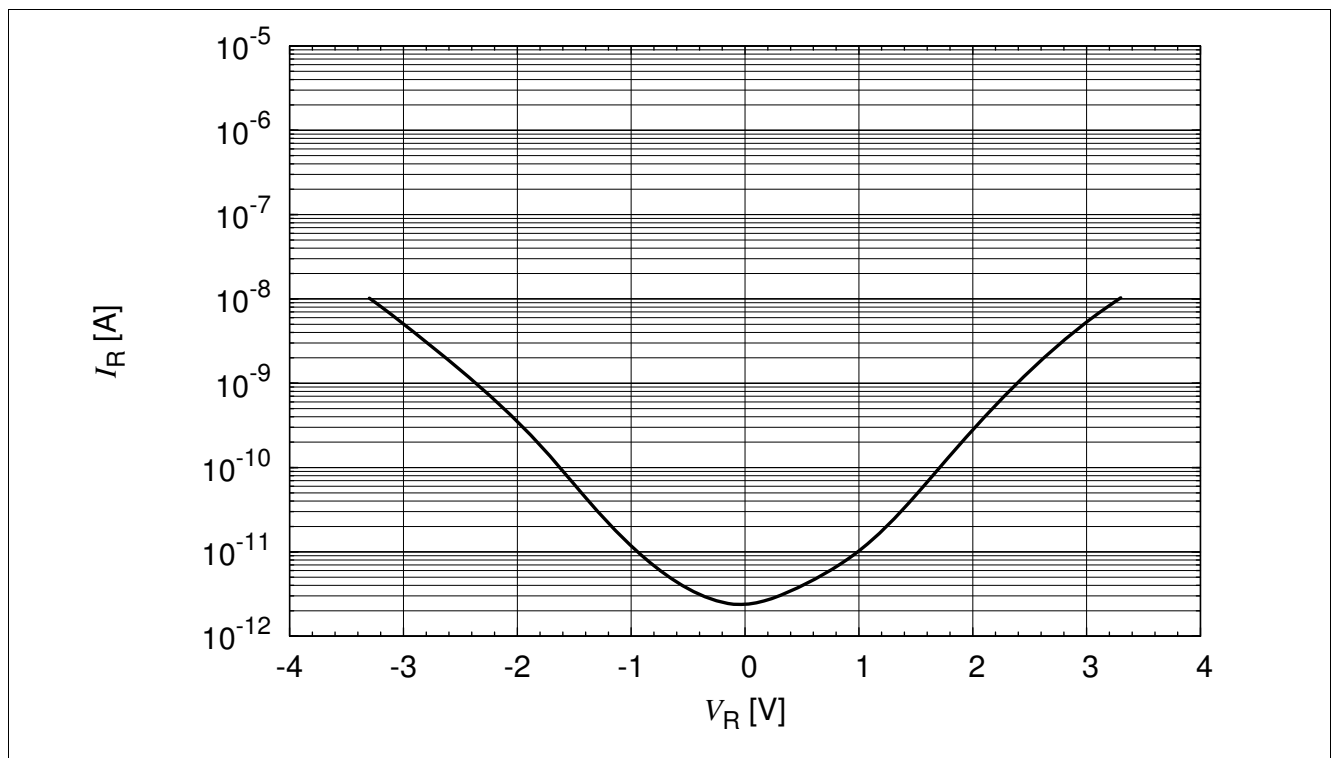
Figure 3-2 Reverse current: $I_R = f(V_R)$

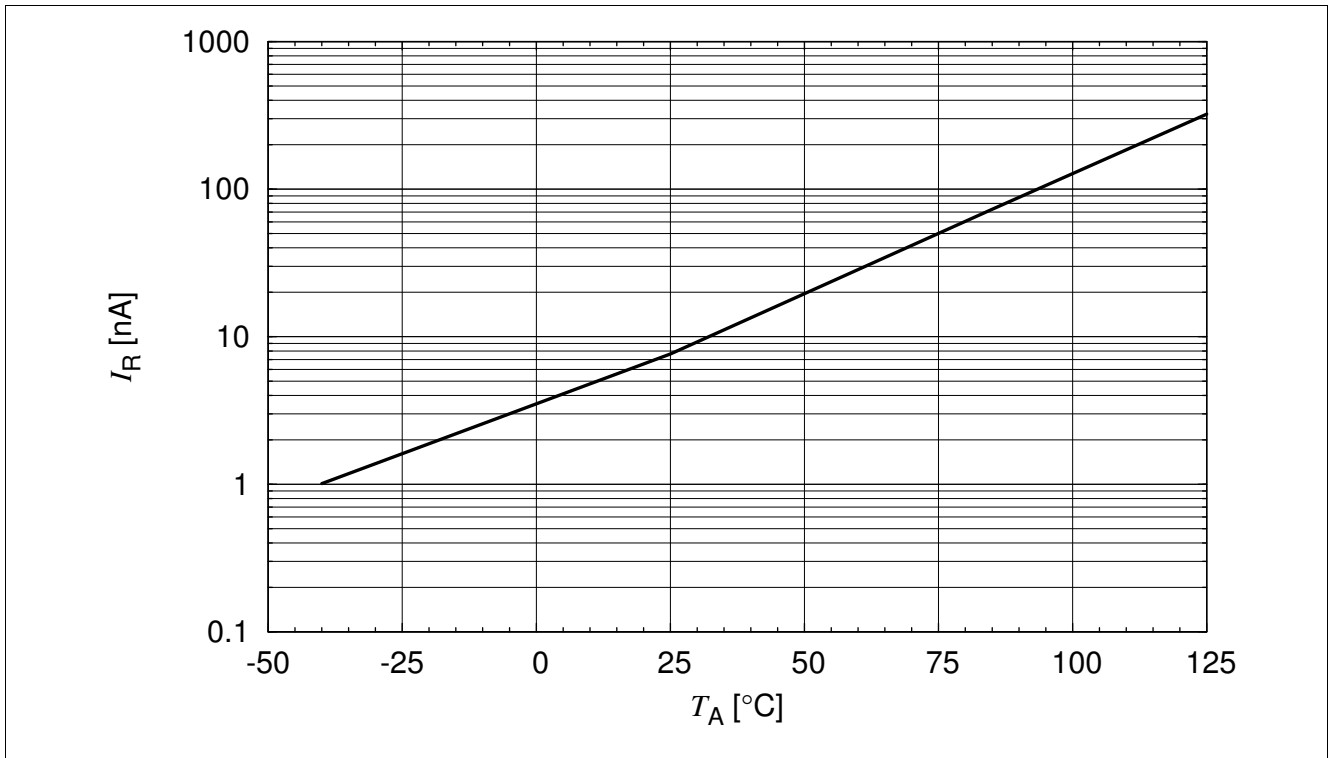

Figure 3-3 Reverse current: $I_R = f(T_A)$, $V_R = 3.3 V$

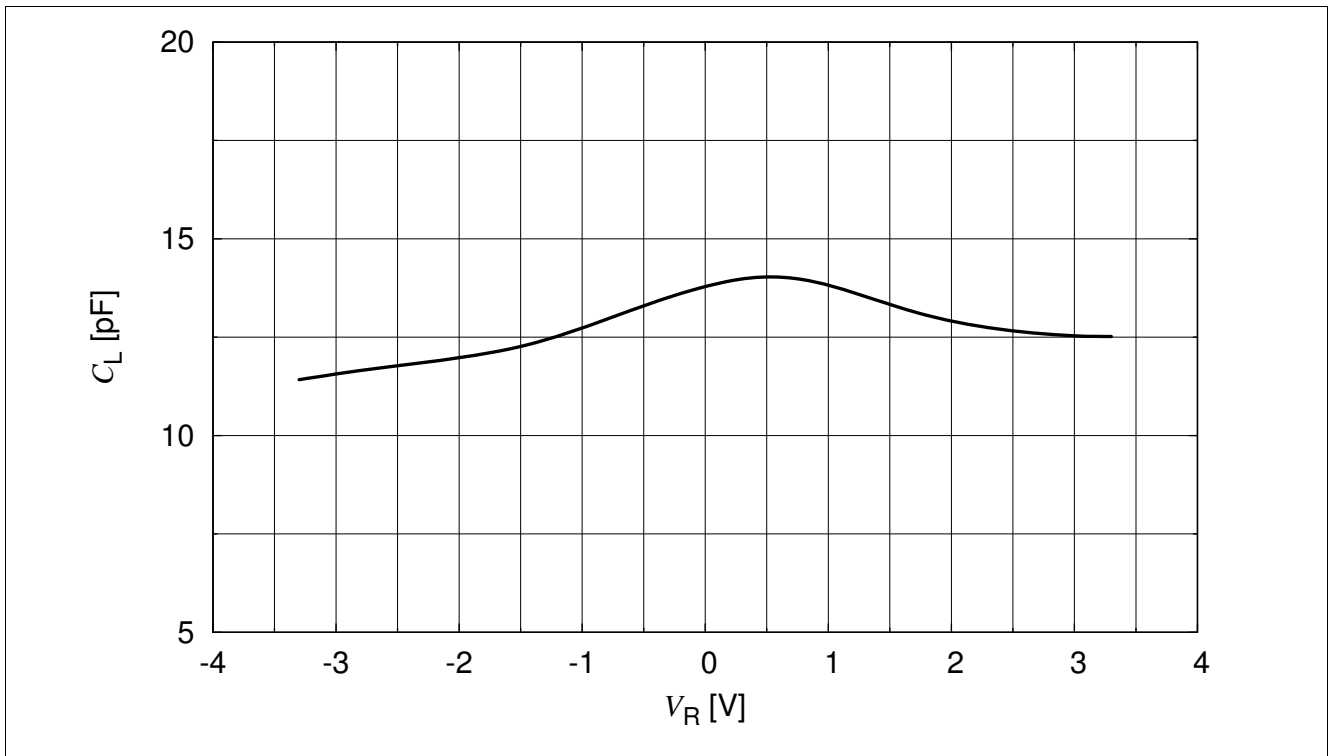

Figure 3-4 Line capacitance: $C_L = f(V_R)$, $f = 1 MHz$

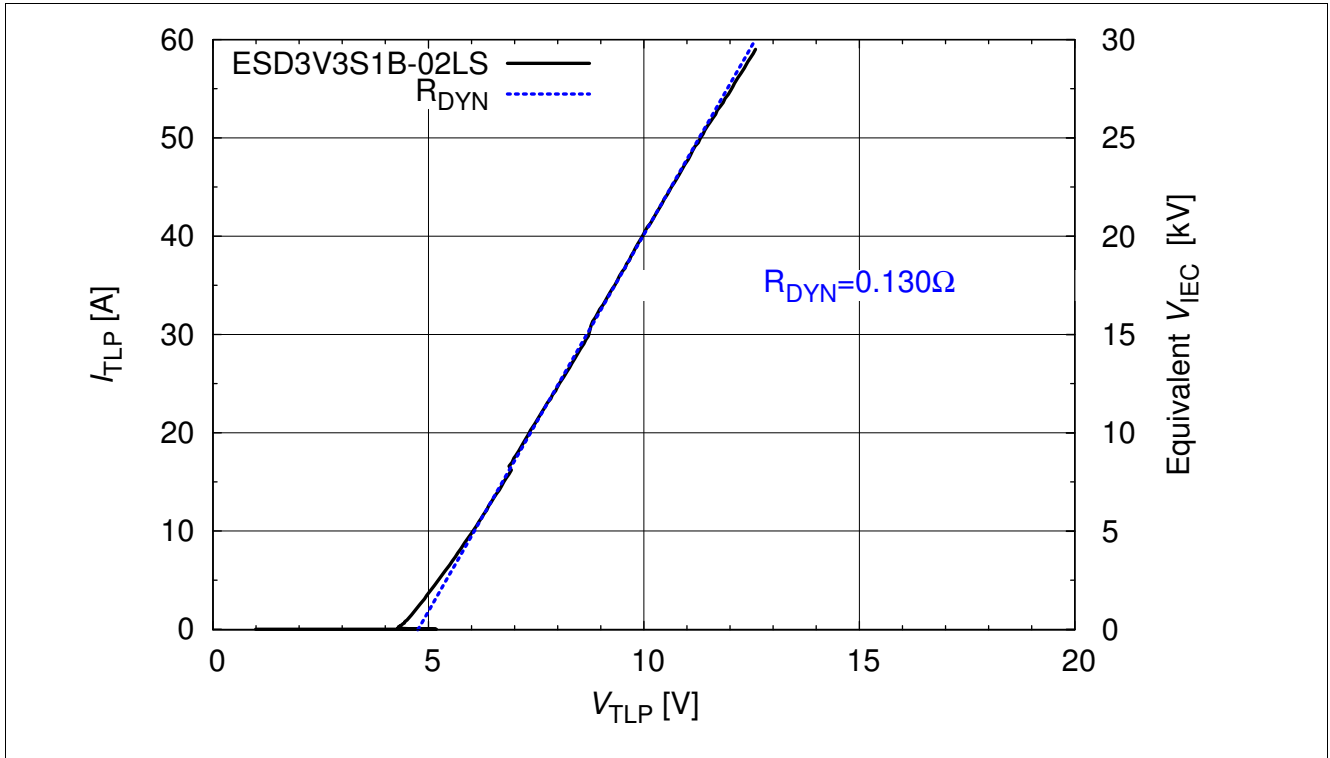

Figure 3-5 Clamping voltage (TLP): $I_{TLP} = f(V_{TLP})$, from pin 1 to pin 2 [1]

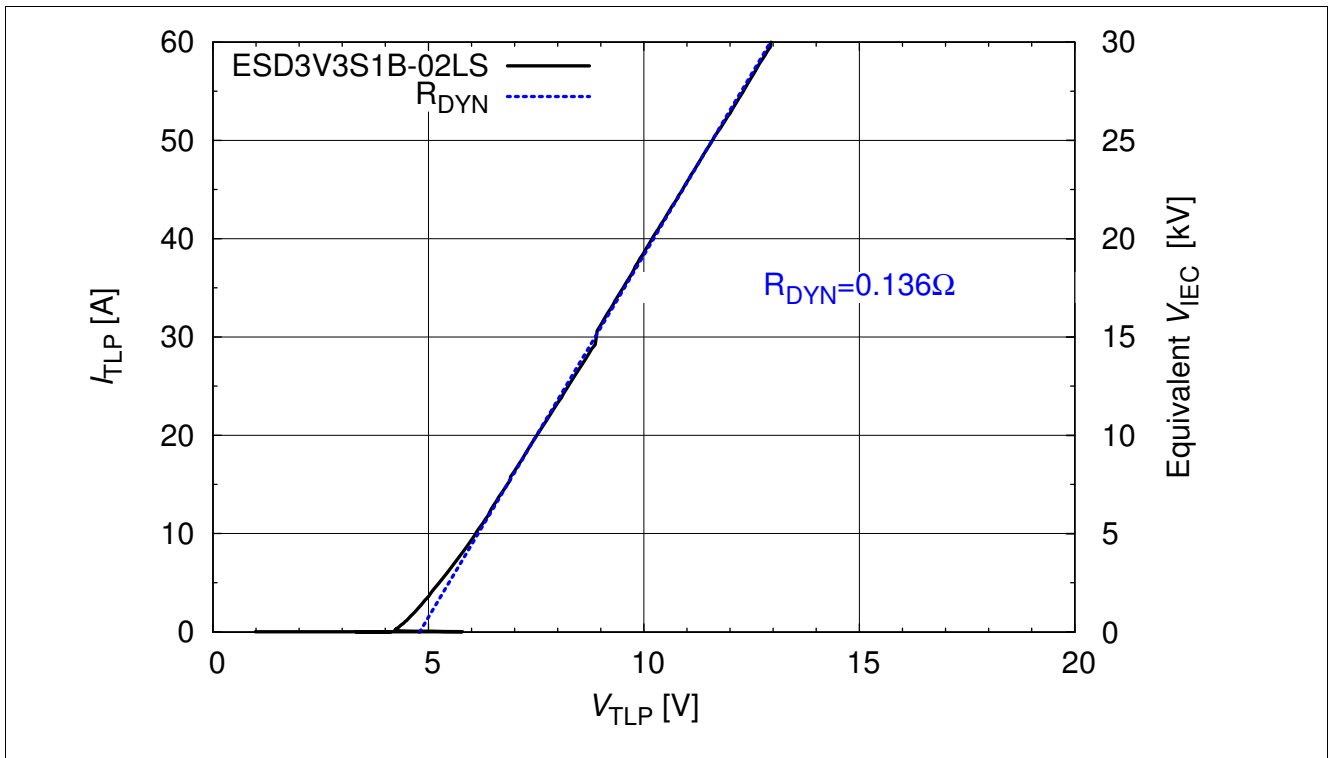

Figure 3-6 Clamping voltage (TLP): $I_{TLP} = f(V_{TLP})$, from pin 2 to pin 1 [1]

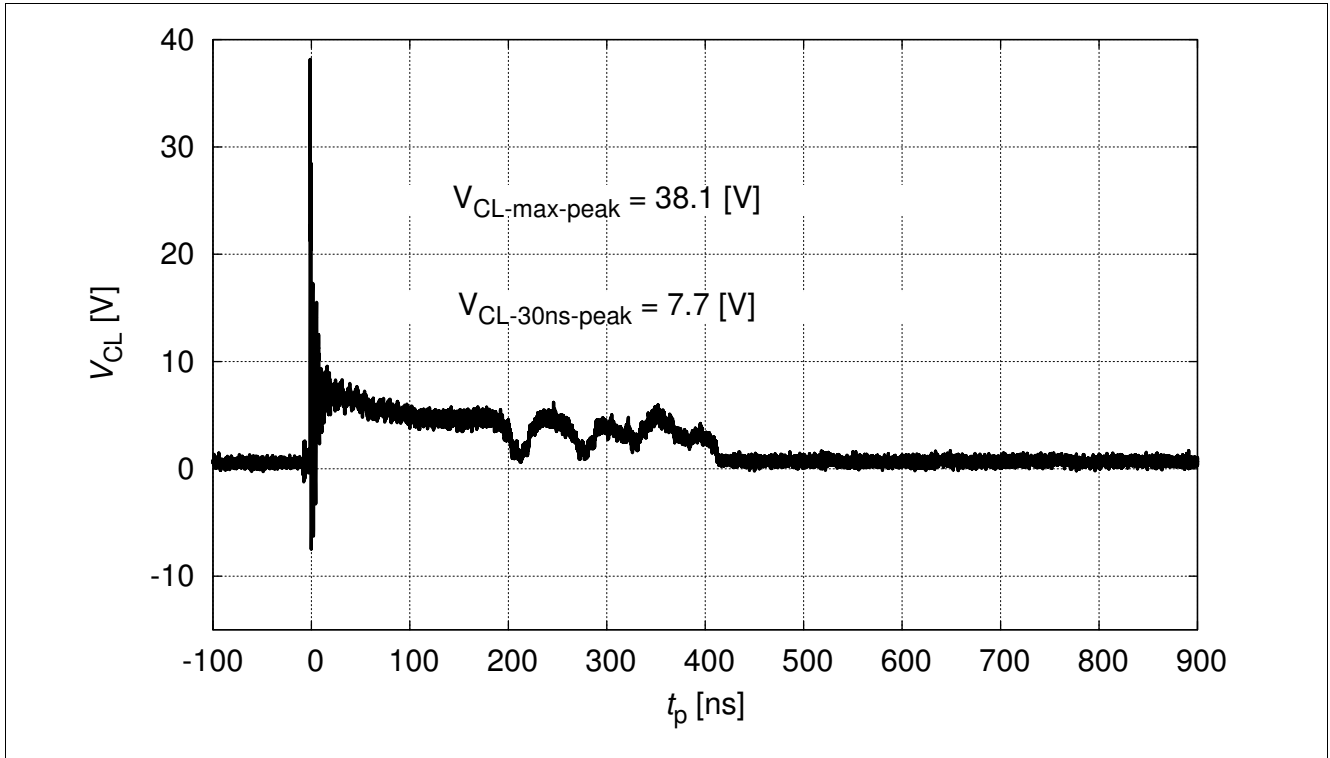

Figure 3-7 IEC61000-4-2 : $V_{CL} = f(t)$, 8 kV positive pulse from pin 1 to pin 2

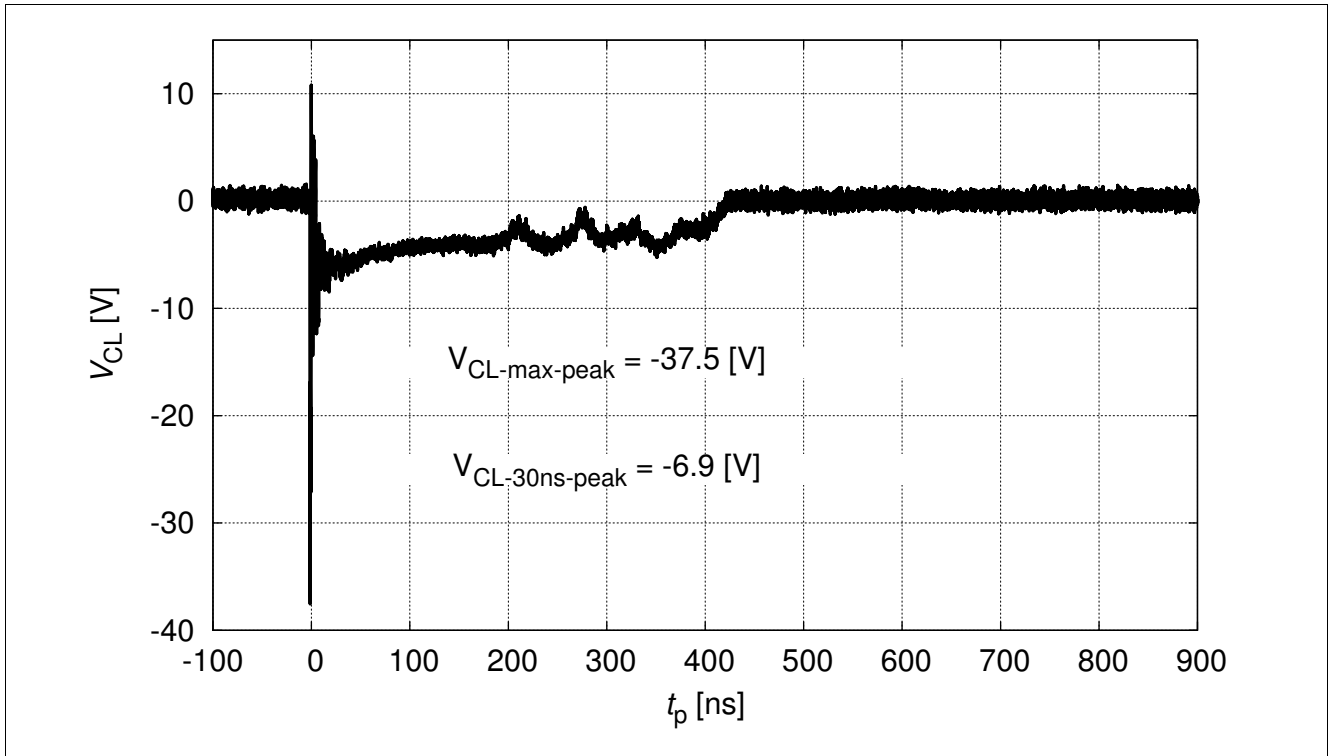

Figure 3-8 IEC61000-4-2 : $V_{CL} = f(t)$, 8 kV negative pulse from pin 1 to pin 2

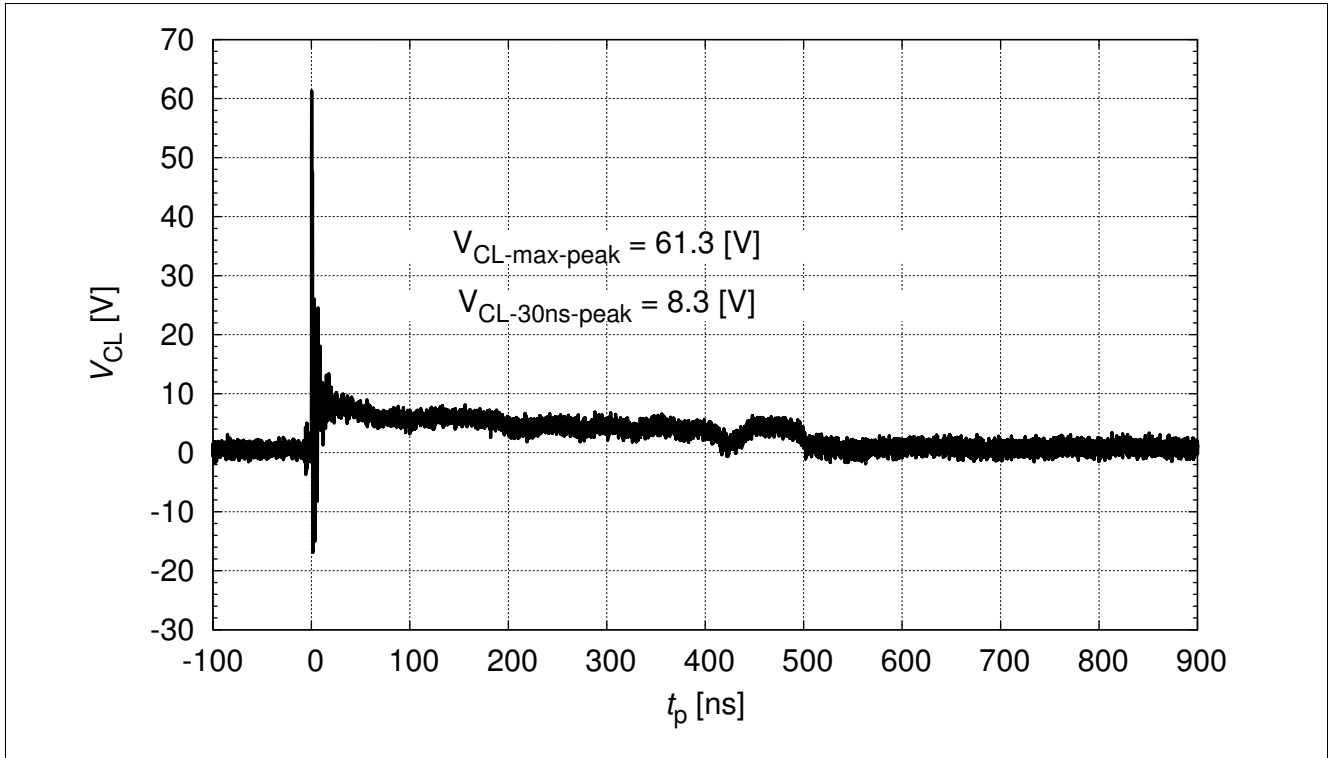

Figure 3-9 IEC61000-4-2 : $V_{CL} = f(t)$, 15 kV positive pulse from pin 1 to pin 2

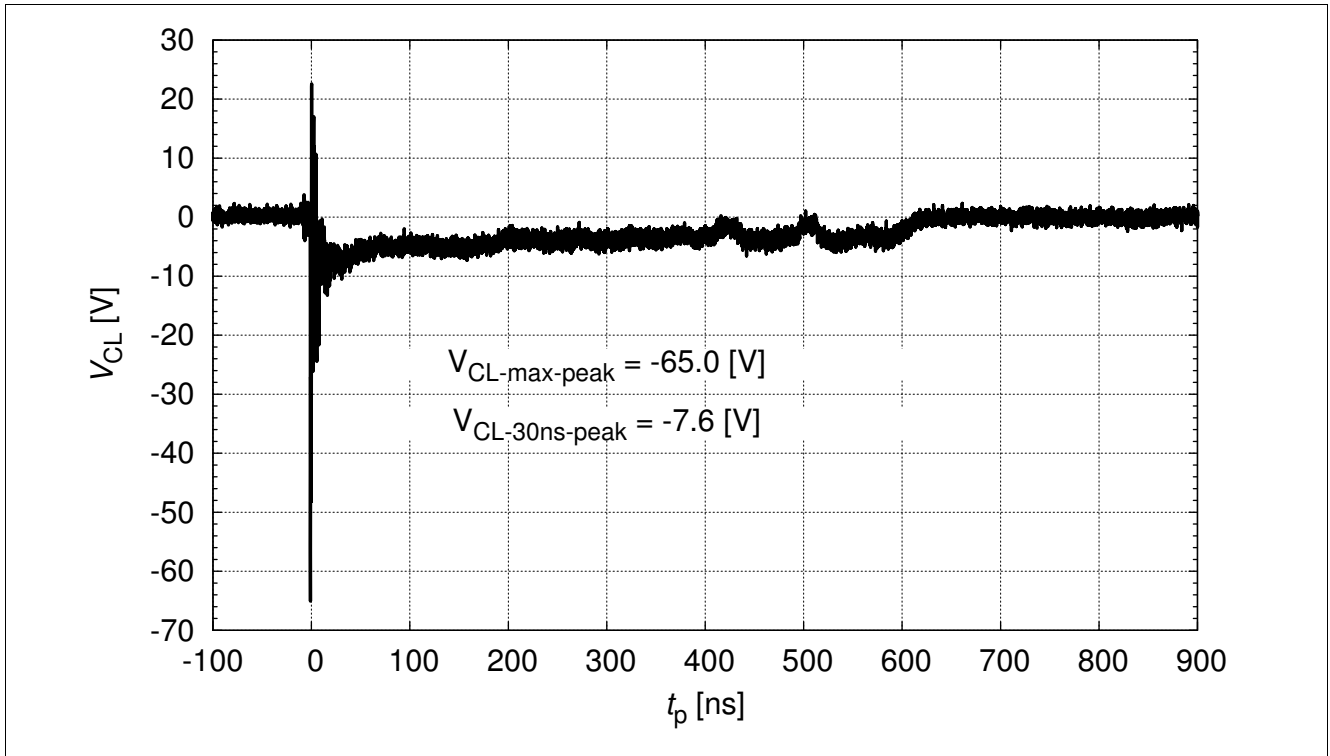

Figure 3-10 IEC61000-4-2 : $V_{CL} = f(t)$, 15 kV negative pulse from pin 1 to pin 2

4 Application Information

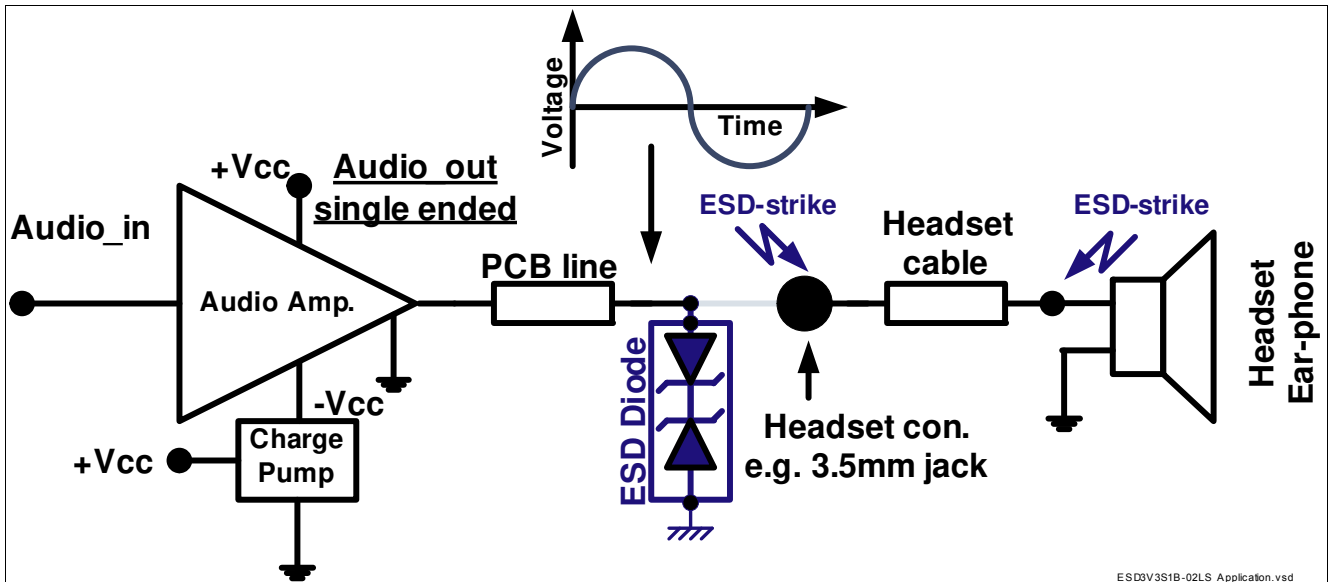

Figure 4-1 Single line, bi-directional ESD / Transient protection

5 Ordering Information Scheme (Examples)

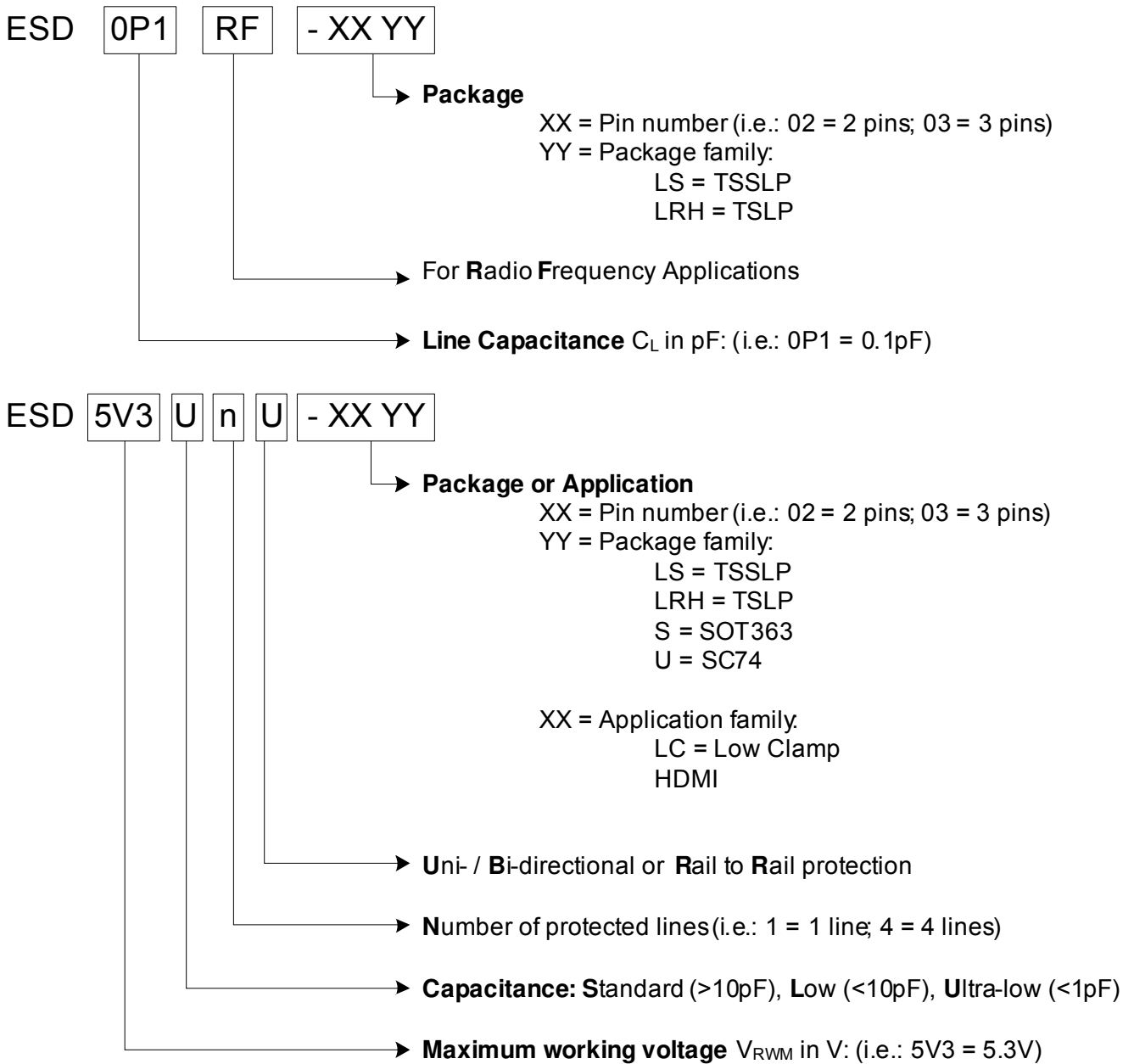

Figure 5-1 Ordering information scheme

6 Package Information

6.1 PG-TSLP-2-17 (mm) [2]

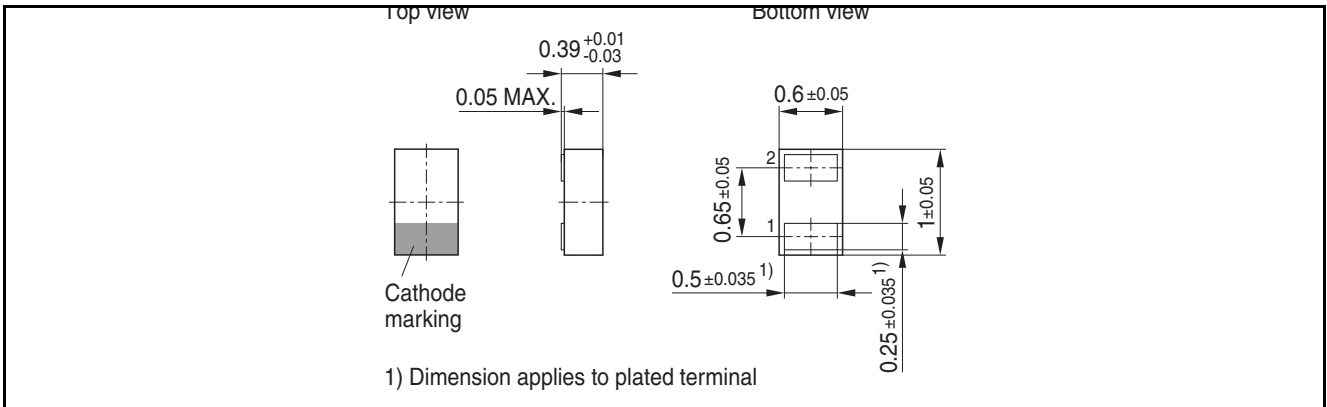

Figure 6-1 PG-TSLP-2-17: Package overview

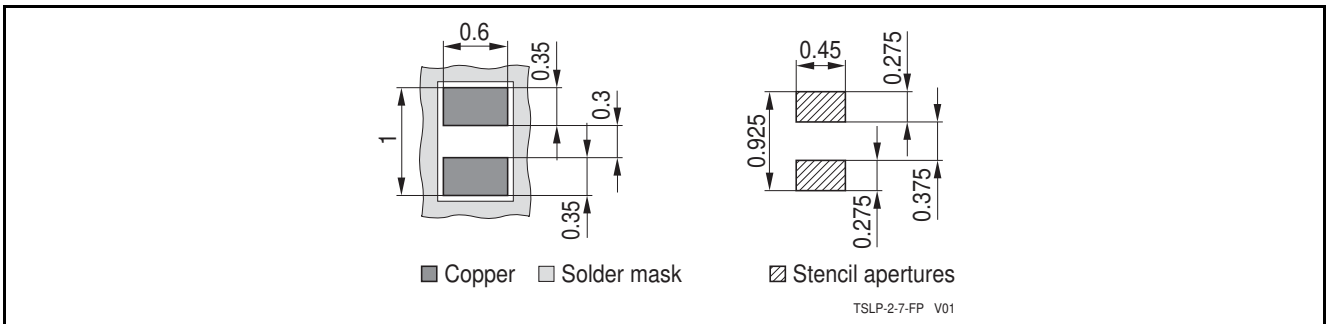

Figure 6-2 PG-TSLP-2-17: Footprint

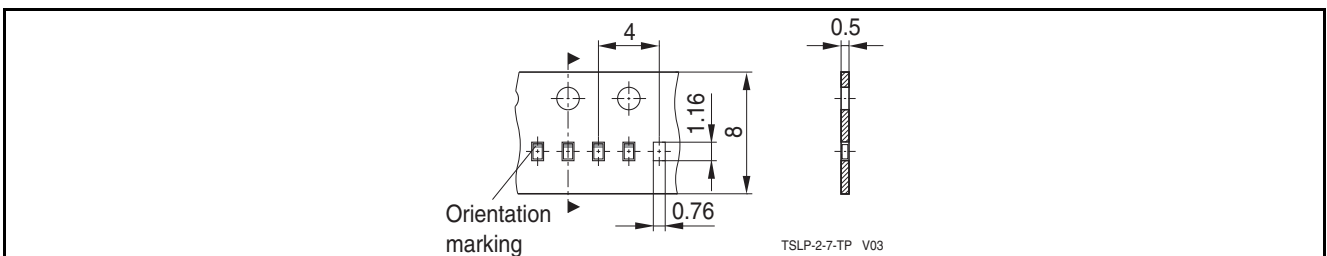

Figure 6-3 PG-TSLP-2-17: Packing

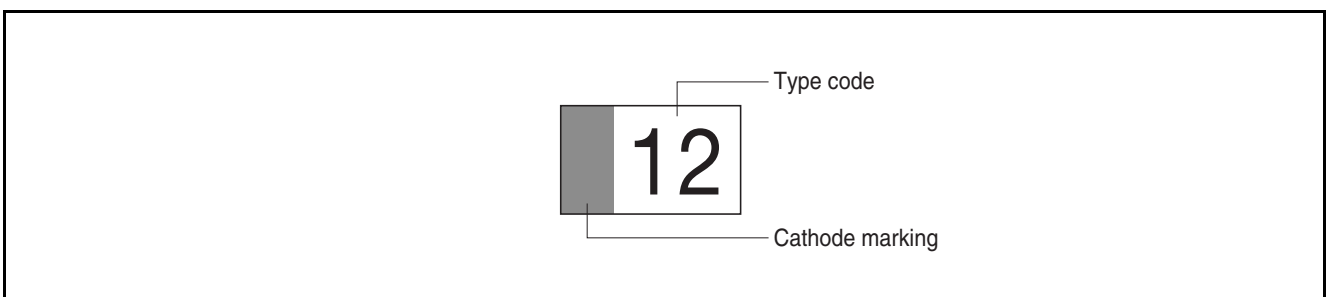

Figure 6-4 PG-TSLP-2-17: Marking (example)

6.2 PG-TSSLP-2-1 (mm) [2]

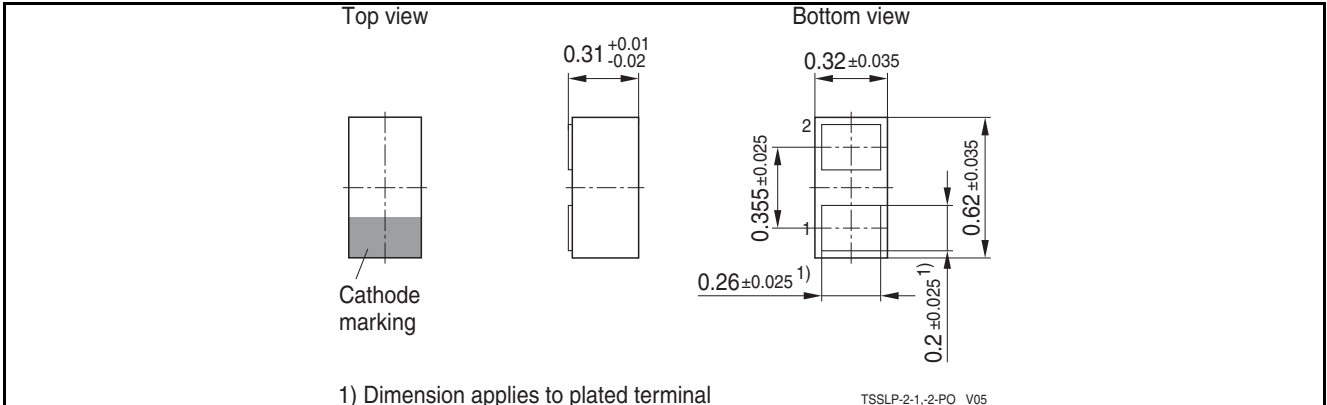

Figure 6-5 PG-TSSLP-2-1: Package overview

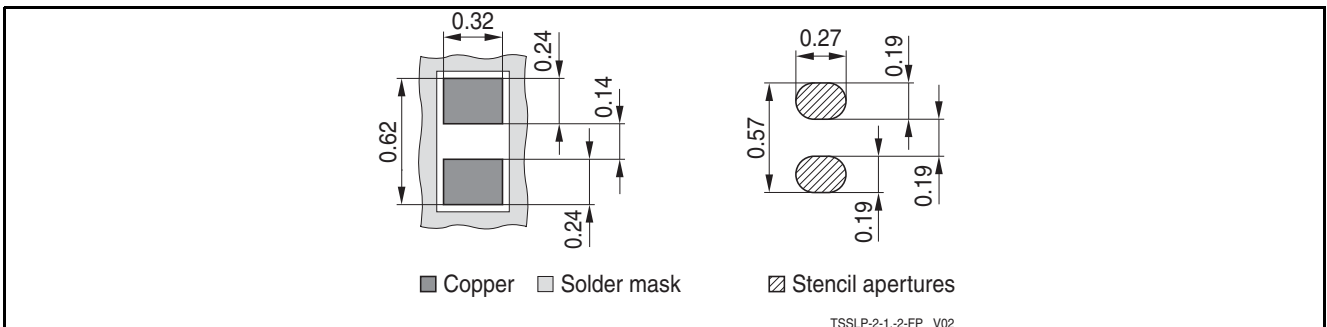

Figure 6-6 PG-TSSLP-2-1: Footprint

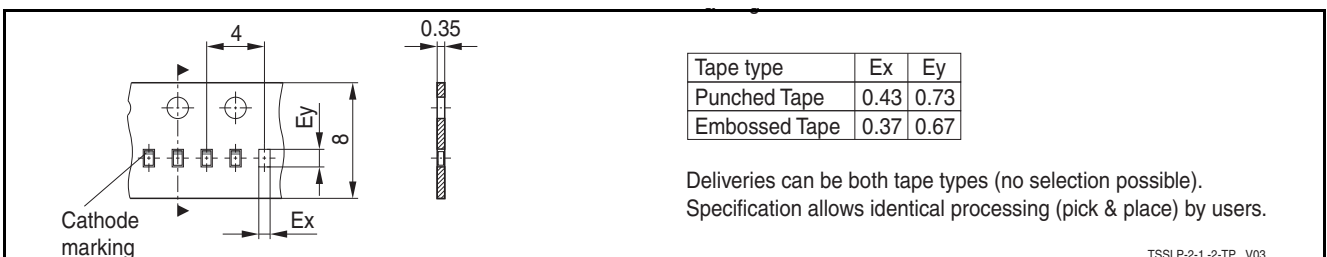

Figure 6-7 PG-TSSLP-2-1: Packing

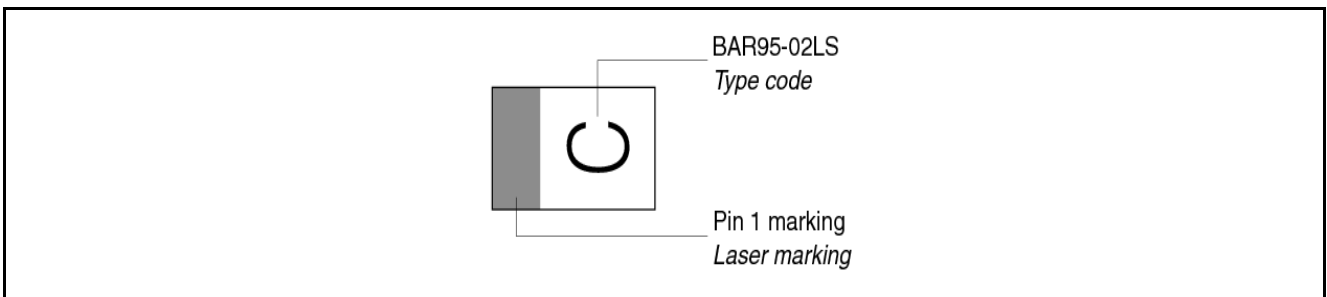

Figure 6-8 PG-TSSLP-2-1: Marking (example)

References

- [1] Infineon AG - **Application Note AN210**: Effective ESD Protection design at System Level Using VF-TLP Characterization Methodology
- [2] Infineon AG - Recommendations for PCB Assembly of Infineon TSLP and TSSLP Packages

Terminology

C_L	Line capacitance
EFT	Electrical Fast Transient
ESD	Electrostatic Discharge
I_{PP}	Peak pulse current
I_R	Reverse current
LCD	Liquid Crystal Display
P_{PK}	Peak pulse power
R_{DYN}	Dynamic resistance
RoHs	Restriction of Hazardous Substance directive
T_A	Ambient temperature
T_{OP}	Operation temperature
t_p	Pulse duration
T_{stg}	Storage temperature
V_{BR}	Breakdown voltage
V_{CL}	Reverse clamping voltage
V_{ESD}	Electrostatic discharge voltage
V_R	Reverse voltage
V_{RWM}	Reverse working voltage maximum

Predefined Names

Name	Initial Cross-Reference
X-GOLD	X-GOLD
XMM	XMM

Definition of “Predefined Names”

Frequently used expressions, such as component names, file names, tools releases, version numbers, proprietary variables and software links, can be used in a similar way as user variables. However, they must be listed in a special table and **not** in the standard file “Variables”.

Correct Usage

Steps:

1. Insert all expressions into the left column of the above table.
2. Insert an initial Cross-Reference into the right column of the same row. The initial Cross-Reference is necessary to ensure that a single ID is used in all your documents using the “Predefined_Names.fm” file (Example: **X-GOLD** has the unique ID = CHDGHJGH).
3. Insert a Cross-Reference (Element “CrossReference”) into your document to the Element Identifier of the “Predefined_Names.fm” file. Set the output format of the Cross-Reference to “Variable” (example: X-GOLD).

Notes

1. All documents in a project (such as XMM) and within a book should use the same file “Predefined Names”. This allows copying content between different documents. For this reason, local versions of “Predefined Names” must not be produced.
2. New definitions must be inserted in a new row. Never change existing definitions, as they might be used in other documents.
3. This file does not need to be included in your book, but it must be in the fm sub-folder of your document.
4. You can sort the above table with FrameMaker only if the initial cross-reference in the right column has been properly inserted. Otherwise, the table may only be sorted by hand, as the cross-references to your document would get lost.

www.infineon.com

Published by Infineon Technologies AG