



Chipsmall Limited consists of a professional team with an average of over 10 year of expertise in the distribution of electronic components. Based in Hongkong, we have already established firm and mutual-benefit business relationships with customers from,Europe,America and south Asia,supplying obsolete and hard-to-find components to meet their specific needs.

With the principle of “Quality Parts,Customers Priority,Honest Operation,and Considerate Service”,our business mainly focus on the distribution of electronic components. Line cards we deal with include Microchip,ALPS,ROHM,Xilinx,Pulse,ON,Everlight and Freescale. Main products comprise IC,Modules,Potentiometer,IC Socket,Relay,Connector.Our parts cover such applications as commercial,industrial, and automotives areas.

We are looking forward to setting up business relationship with you and hope to provide you with the best service and solution. Let us make a better world for our industry!



Contact us

Tel: +86-755-8981 8866 Fax: +86-755-8427 6832

Email & Skype: info@chipsmall.com Web: www.chipsmall.com

Address: A1208, Overseas Decoration Building, #122 Zhenhua RD., Futian, Shenzhen, China



ESD5384

5-Line HDMI Control Line ESD Protection

Functional Description

The ESD5384 chip is a low capacitance ESD protection for HDMI control pins. It also integrates pull-up resistor for I²C bus and pull-down resistor for hot plug detect and pull-up resistor for CEC line.

The ESD protection circuitry prevents damage to the protected device when subjected to ESD surges up to 15 kV.

The ESD5384 is available in 9 bump CSP package.

Features

- Line Capacitance: 12 pF max
- IEC 61000-4-2 Level 4
 - ◆ ±15 kV (air discharge)
 - ◆ ±8 kV (contact discharge)
- This is a Pb-Free Device

Applications

- HDMI Control Line Interfaces
 - ◆ Smart Phones
 - ◆ Tablets
 - ◆ Consumer Electronics



ON Semiconductor[®]

<http://onsemi.com>



**WLCSP9
CASE 567CX**

MARKING DIAGRAM

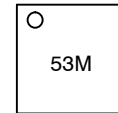

53 = Specific Device Code
M = Date Code

PINOUT

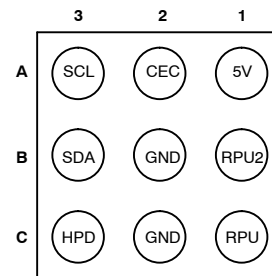

(Bump Side)

ORDERING INFORMATION

See detailed ordering and shipping information in the package dimensions section on page 7 of this data sheet.

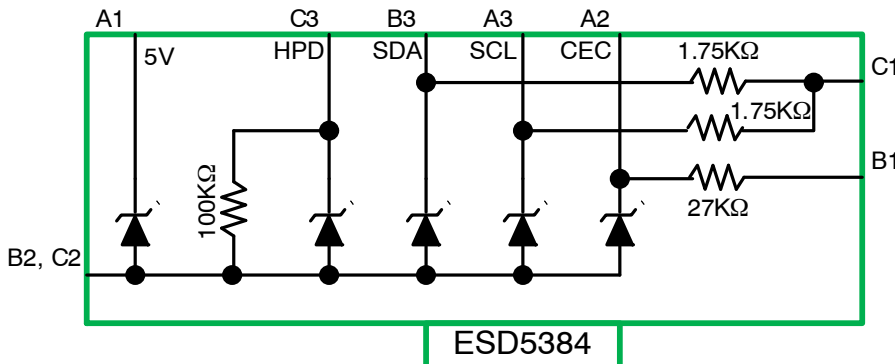

Figure 1. Electrical Schematic

ESD5384

ABSOLUTE MAXIMUM RATINGS

Symbol	Parameter	Value	Unit
V _{PP}	External pins (A1, A2, A3, B3 and C3): ESD IEC 61000-4-2, level 4 – air discharge ESD IEC 61000-4-2, level 4 – contact discharge Internal pins (B1, C1): ESD IEC 61000-4-2, level 1 – air discharge ESD IEC 61000-4-2, level 1 – contact discharge	± 15 ± 8 ± 2 ± 2	kV
T _{op}	Operating Temperature Range	-30 to +85	°C
T _{stg}	Storage Temperature Range	-55 to +150	°C

Stresses exceeding Maximum Ratings may damage the device. Maximum Ratings are stress ratings only. Functional operation above the Recommended Operating Conditions is not implied. Extended exposure to stresses above the Recommended Operating Conditions may affect device reliability.

ELECTRICAL CHARACTERISTICS (Note 1)

Symbol	Test Condition	Min	Typ	Max	Unit
V _{BR}	Breakdown Voltage (I _r = 1mA)	6		20	V
I _{RM}	Leakage Current @ V _{rm} (V _{rm} = 3 V per line), excluding HPD line		50	200	nA
I _{RM}	Leakage Current @ V _{rm} (V _{rm} = 3 V per line), HPD line			32	µA
R1, R2	Resistance	1575	1750	1925	Ω
R3	Pull-up Resistance	80	100	120	kΩ
R4	Pull-up Resistance	22	27	32	kΩ
C _{line}	V _{line} = 0 V, V _{osc} = 30 mV, F = 1 MHz, A2 with B1 not connected		14	17	pF
	V _{line} = 0 V, V _{osc} = 30 mV, F = 1 MHz, A3, B3 with C1 not connected.		24	29	
	V _{line} = 0 V, V _{osc} = 30 mV, F = 1 MHz, A2, A3, B3 with C1 and B1 grounded		10	12	

1. All parameters specified at T_A = 25°C unless otherwise noted.

TYPICAL CHARACTERISTICS

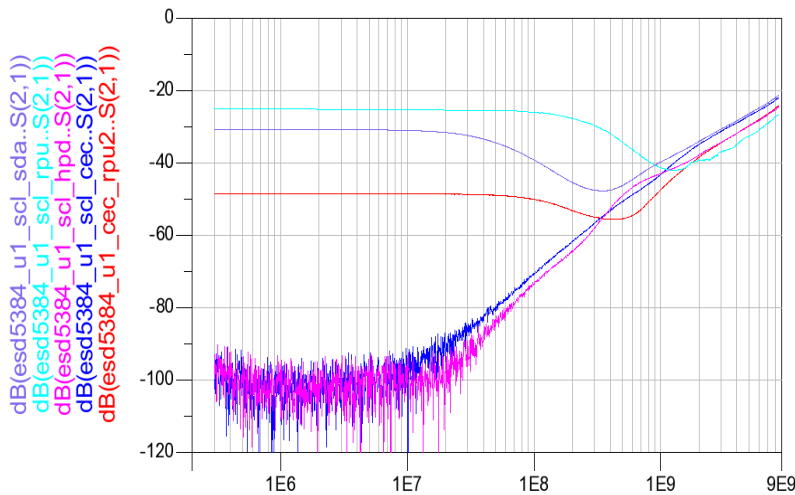

Figure 2. Crosstalk Measurements

TYPICAL CHARACTERISTICS

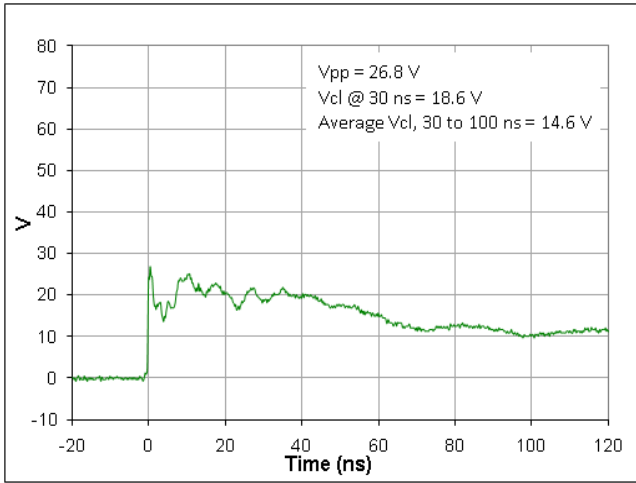

Figure 3. ESD Clamping Voltage Screenshot Positive 8 kV Contact per IEC61000-4-2, CEC line

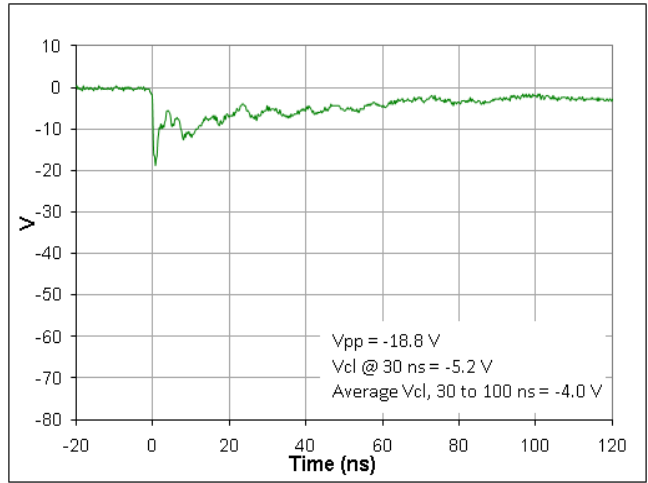

Figure 4. ESD Clamping Voltage Screenshot Negative 8 kV Contact per IEC61000-4-2, CEC line

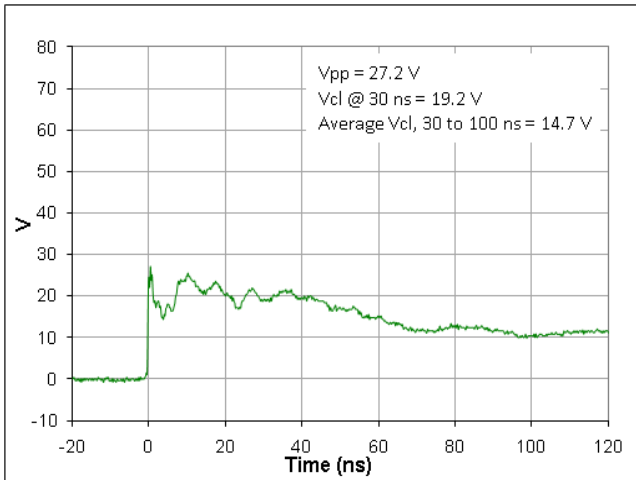

Figure 5. ESD Clamping Voltage Screenshot Positive 8 kV Contact per IEC61000-4-2, SCL line

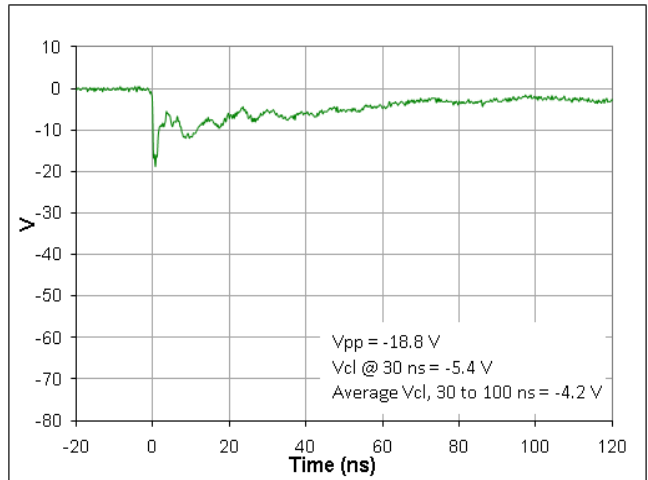

Figure 6. ESD Clamping Voltage Screenshot Negative 8 kV Contact per IEC61000-4-2, SCL line

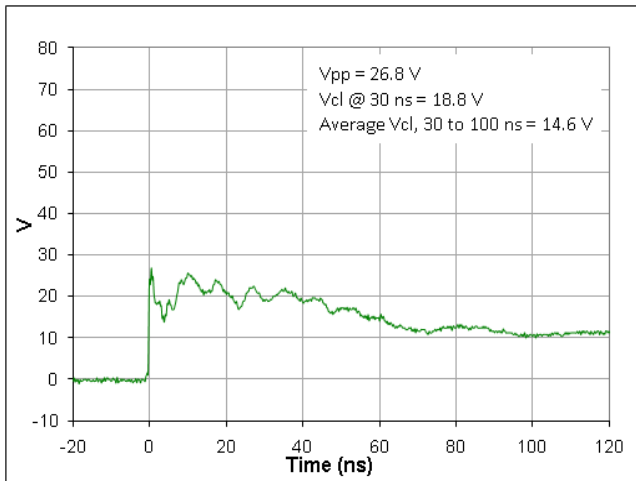

Figure 7. ESD Clamping Voltage Screenshot Positive 8 kV Contact per IEC61000-4-2, SDA line

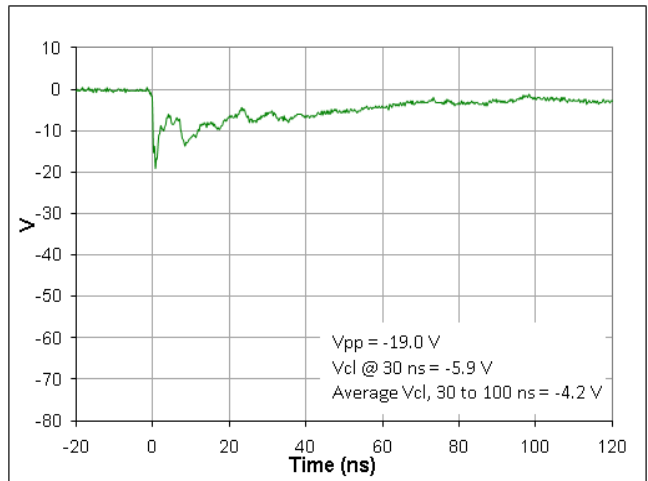

Figure 8. ESD Clamping Voltage Screenshot Negative 8 kV Contact per IEC61000-4-2, SDA line

TYPICAL CHARACTERISTICS

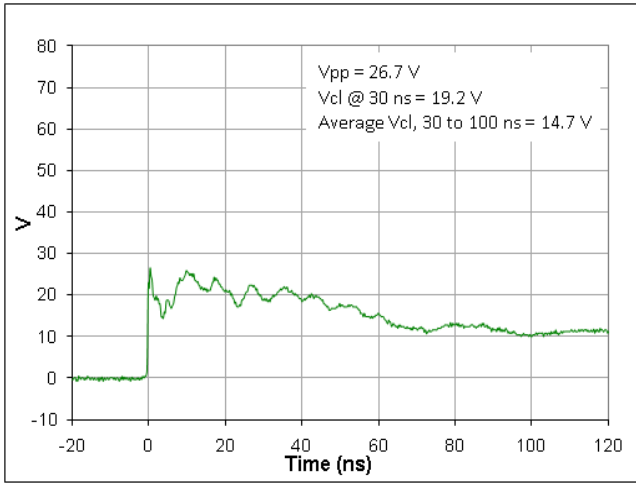

Figure 9. ESD Clamping Voltage Screenshot Positive 8 kV Contact per IEC61000-4-2, HPD line

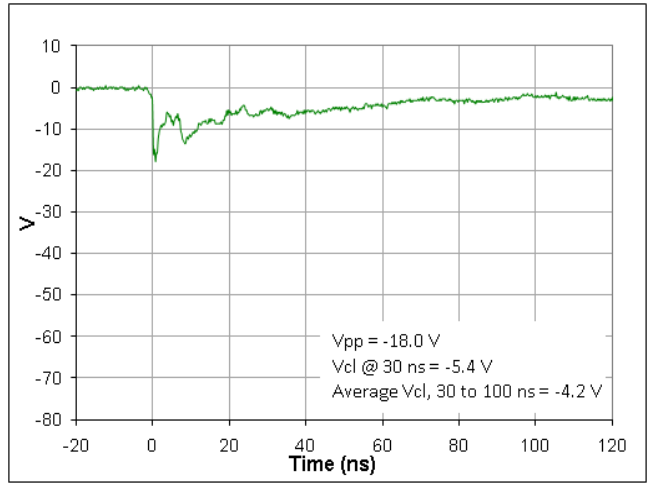

Figure 10. ESD Clamping Voltage Screenshot Negative 8 kV Contact per IEC61000-4-2, HPD line

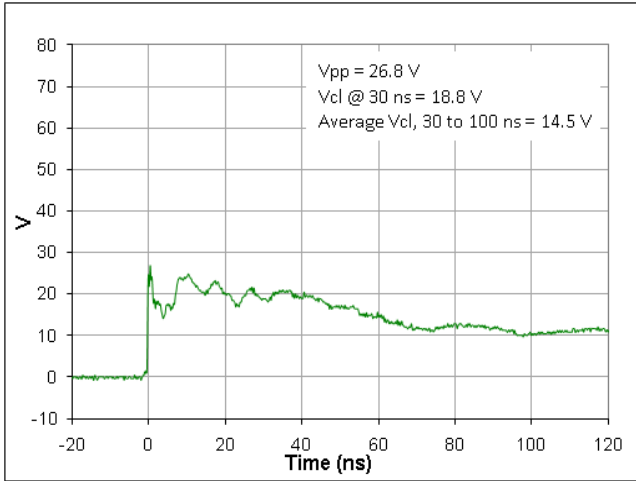

Figure 11. ESD Clamping Voltage Screenshot Positive 8 kV Contact per IEC61000-4-2, 5 V line

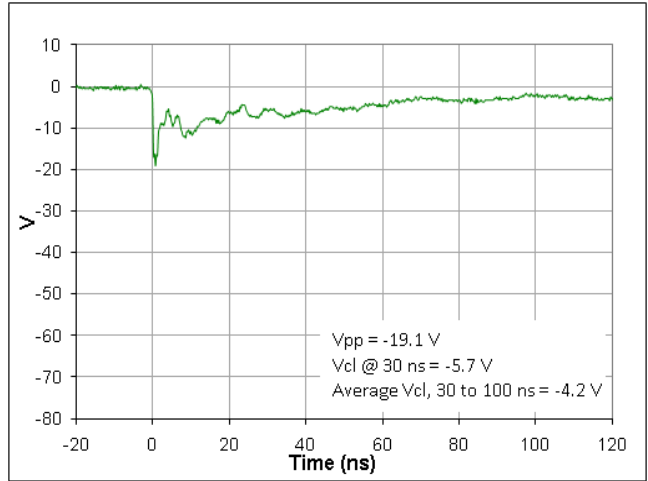

Figure 12. ESD Clamping Voltage Screenshot Negative 8 kV Contact per IEC61000-4-2, 5 V line

IEC61000-4-2 Spec.

Level	Test Voltage (kV)	First Peak Current (A)	Current at 30 ns (A)	Current at 60 ns (A)
1	2	7.5	4	2
2	4	15	8	4
3	6	22.5	12	6
4	8	30	16	8

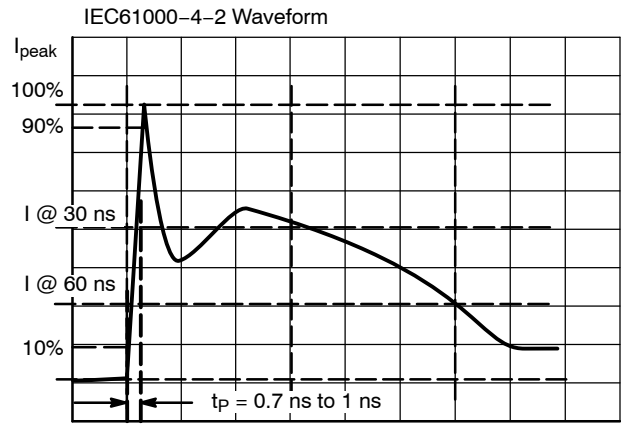

Figure 13. IEC61000-4-2 Spec

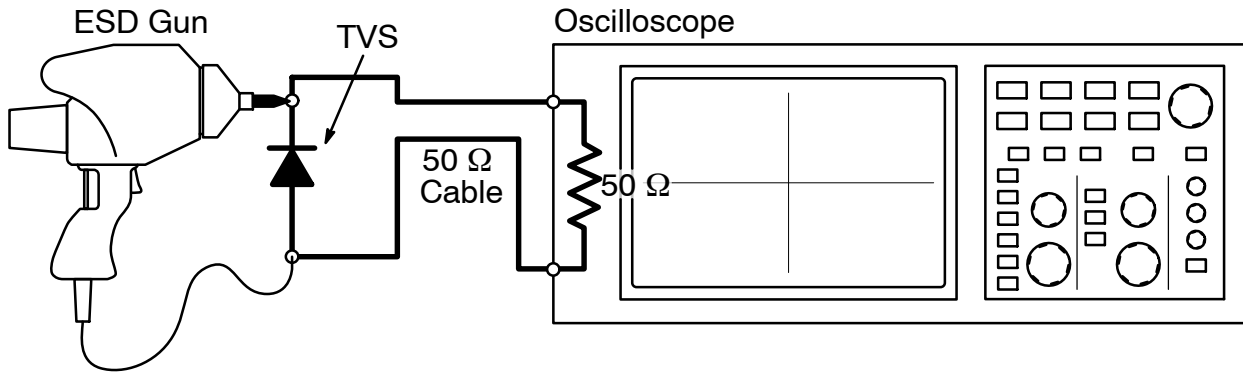

Figure 14. Diagram of ESD Clamping Voltage Test Setup

The following is taken from Application Note AND8308/D – Interpretation of Datasheet Parameters for ESD Devices.

ESD Voltage Clamping

For sensitive circuit elements it is important to limit the voltage that an IC will be exposed to during an ESD event to as low a voltage as possible. The ESD clamping voltage is the voltage drop across the ESD protection diode during an ESD event per the IEC61000-4-2 waveform. Since the IEC61000-4-2 was written as a pass/fail spec for larger

systems such as cell phones or laptop computers it is not clearly defined in the spec how to specify a clamping voltage at the device level. ON Semiconductor has developed a way to examine the entire voltage waveform across the ESD protection diode over the time domain of an ESD pulse in the form of an oscilloscope screenshot, which can be found on the datasheets for all ESD protection diodes. For more information on how ON Semiconductor creates these screenshots and how to interpret them please refer to AND8307/D.

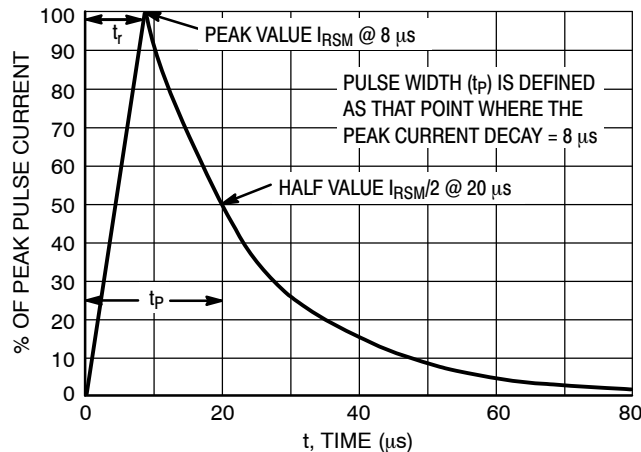

Figure 15. 8 x 20 μs Pulse Waveform

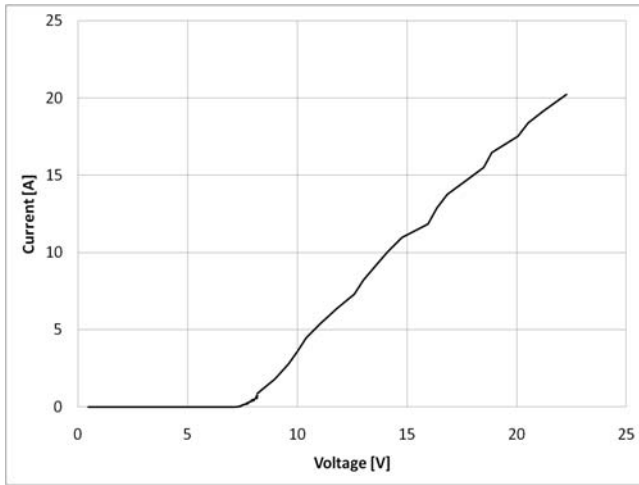

Figure 16. Positive TLP I-V Curve

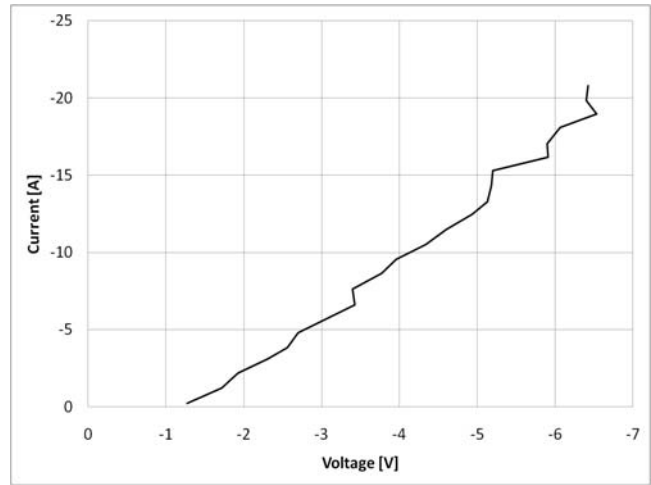

Figure 17. Negative TLP I-V Curve

Transmission Line Pulse (TLP) Measurement

Transmission Line Pulse (TLP) provides current versus voltage (I-V) curves in which each data point is obtained from a 100 ns long rectangular pulse from a charged transmission line. A simplified schematic of a typical TLP system is shown in Figure 18. TLP I-V curves of ESD protection devices accurately demonstrate the product’s ESD capability because the 10s of amps current levels and under 100 ns time scale match those of an ESD event. This is illustrated in Figure 19 where an 8 kV IEC61000-4-2 current waveform is compared with TLP current pulses at 8 A and 16 A. A TLP I-V curve shows the voltage at which the device turns on as well as how well the device clamps voltage over a range of current levels. A typical TLP I-V curve for the ESD7383 is shown in Figures 16 and 17.

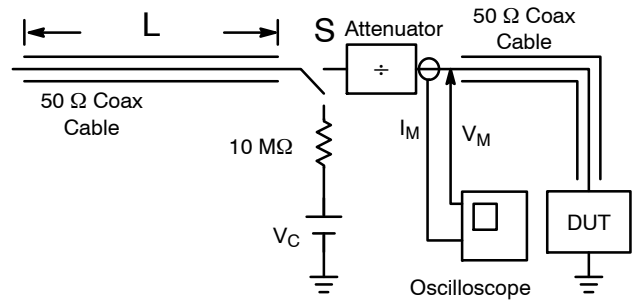

Figure 18. Simplified Schematic of a Typical TLP System

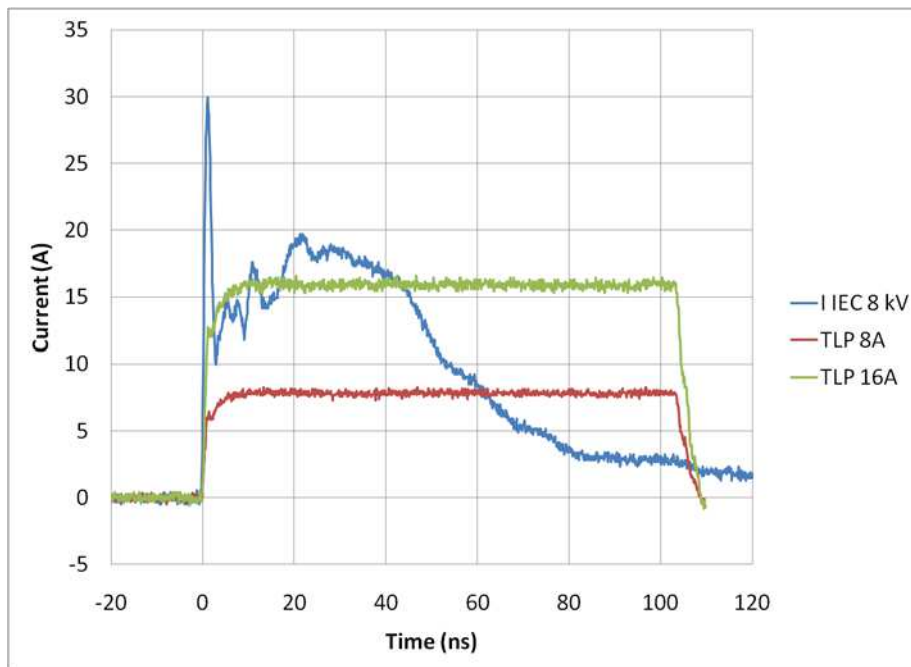

Figure 19. Comparison Between 8 kV IEC61000-4-2 and 8 A and 16 A TLP Waveforms

ESD5384

TYPICAL APPLICATION SCHEMATIC

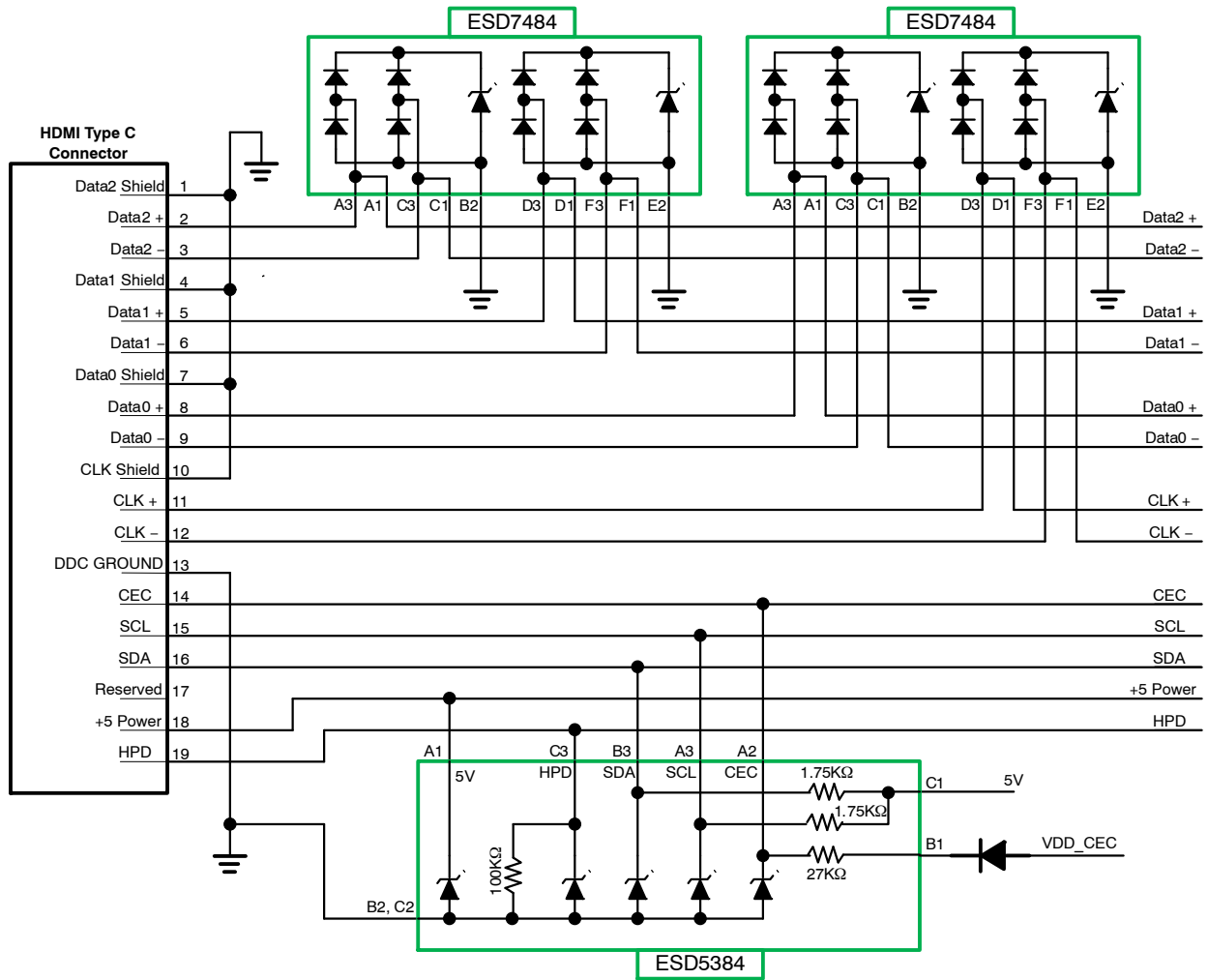

Figure 20. Typical Application Schematic

ORDERING INFORMATION

Part Number	Chip Size (mm)	Package	Shipping†
ESD5384	1.14 x 1.14 x 0.605	WLCSP9 (Pb-Free)	5000 / Tape & Reel

†For information on tape and reel specifications, including part orientation and tape sizes, please refer to our Tape and Reel Packaging Specifications Brochure, BRD8011/D.

ESD5384

PACKAGE DIMENSIONS

WLCSP9, 1.14x1.14
CASE 567CX-01
ISSUE O

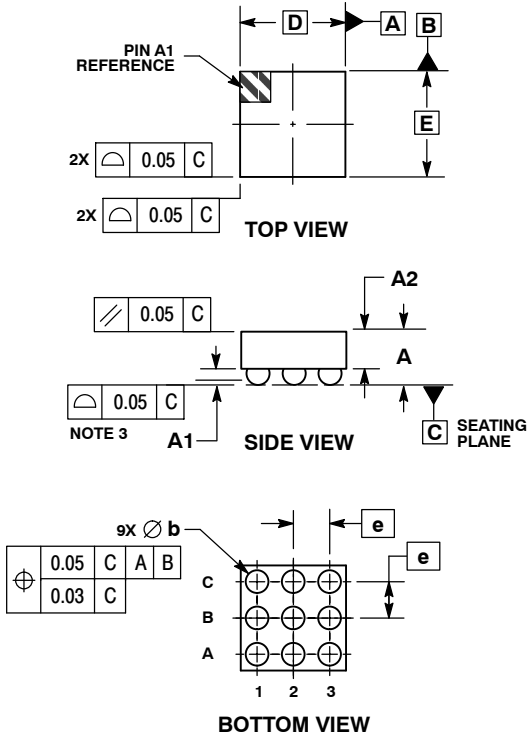

NOTES:

1. DIMENSIONING AND TOLERANCING PER ASME Y14.5M, 1994.
2. CONTROLLING DIMENSION: MILLIMETERS.
3. COPLANARITY APPLIES TO SPHERICAL CROWNS OF SOLDER BALLS.

DIM	MILLIMETERS	
	MIN	MAX
A	0.57	0.63
A1	0.17	0.24
A2	0.41 REF	
b	0.24	0.29
D	1.14 BSC	
E	1.14 BSC	
e	0.40 BSC	

RECOMMENDED SOLDERING FOOTPRINT*

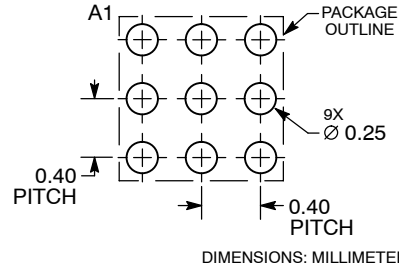

*For additional information on our Pb-Free strategy and soldering details, please download the ON Semiconductor Soldering and Mounting Techniques Reference Manual, SOLDERRM/D.

ON Semiconductor and are registered trademarks of Semiconductor Components Industries, LLC (SCILLC). SCILLC reserves the right to make changes without further notice to any products herein. SCILLC makes no warranty, representation or guarantee regarding the suitability of its products for any particular purpose, nor does SCILLC assume any liability arising out of the application or use of any product or circuit, and specifically disclaims any and all liability, including without limitation special, consequential or incidental damages. "Typical" parameters which may be provided in SCILLC data sheets and/or specifications can and do vary in different applications and actual performance may vary over time. All operating parameters, including "Typicals" must be validated for each customer application by customer's technical experts. SCILLC does not convey any license under its patent rights nor the rights of others. SCILLC products are not designed, intended, or authorized for use as components in systems intended for surgical implant into the body, or other applications intended to support or sustain life, or for any other application in which the failure of the SCILLC product could create a situation where personal injury or death may occur. Should Buyer purchase or use SCILLC products for any such unintended or unauthorized application, Buyer shall indemnify and hold SCILLC and its officers, employees, subsidiaries, affiliates, and distributors harmless against all claims, costs, damages, and expenses, and reasonable attorney fees arising out of, directly or indirectly, any claim of personal injury or death associated with such unintended or unauthorized use, even if such claim alleges that SCILLC was negligent regarding the design or manufacture of the part. SCILLC is an Equal Opportunity/Affirmative Action Employer. This literature is subject to all applicable copyright laws and is not for resale in any manner.

PUBLICATION ORDERING INFORMATION

LITERATURE FULFILLMENT:

Literature Distribution Center for ON Semiconductor
P.O. Box 5163, Denver, Colorado 80217 USA
Phone: 303-675-2175 or 800-344-3860 Toll Free USA/Canada
Fax: 303-675-2176 or 800-344-3867 Toll Free USA/Canada
Email: orderlit@onsemi.com

N. American Technical Support: 800-282-9855 Toll Free
USA/Canada
Europe, Middle East and Africa Technical Support:
Phone: 421 33 790 2910
Japan Customer Focus Center
Phone: 81-3-5773-3850

ON Semiconductor Website: www.onsemi.com
Order Literature: <http://www.onsemi.com/orderlit>

For additional information, please contact your local Sales Representative