



Chipsmall Limited consists of a professional team with an average of over 10 year of expertise in the distribution of electronic components. Based in Hongkong, we have already established firm and mutual-benefit business relationships with customers from,Europe,America and south Asia,supplying obsolete and hard-to-find components to meet their specific needs.

With the principle of “Quality Parts,Customers Priority,Honest Operation,and Considerate Service”,our business mainly focus on the distribution of electronic components. Line cards we deal with include Microchip,ALPS,ROHM,Xilinx,Pulse,ON,Everlight and Freescale. Main products comprise IC,Modules,Potentiometer,IC Socket,Relay,Connector.Our parts cover such applications as commercial,industrial, and automotives areas.

We are looking forward to setting up business relationship with you and hope to provide you with the best service and solution. Let us make a better world for our industry!



Contact us

Tel: +86-755-8981 8866 Fax: +86-755-8427 6832

Email & Skype: info@chipsmall.com Web: www.chipsmall.com

Address: A1208, Overseas Decoration Building, #122 Zhenhua RD., Futian, Shenzhen, China



TVS Diode

Transient Voltage Suppressor Diode

ESD5V3U4U-HDMI

Uni-directional Ultra-low Capacitance ESD / Transient Protection Array

ESD5V3U4U-HDMI

Data Sheet

Revision 1.1, 2012-07-03
Final

Edition 2012-07-03

**Published by
Infineon Technologies AG
81726 Munich, Germany**

**© 2012 Infineon Technologies AG
All Rights Reserved.**

Legal Disclaimer

The information given in this document shall in no event be regarded as a guarantee of conditions or characteristics. With respect to any examples or hints given herein, any typical values stated herein and/or any information regarding the application of the device, Infineon Technologies hereby disclaims any and all warranties and liabilities of any kind, including without limitation, warranties of non-infringement of intellectual property rights of any third party.

Information

For further information on technology, delivery terms and conditions and prices, please contact the nearest Infineon Technologies Office (www.infineon.com).

Warnings

Due to technical requirements, components may contain dangerous substances. For information on the types in question, please contact the nearest Infineon Technologies Office.

Infineon Technologies components may be used in life-support devices or systems only with the express written approval of Infineon Technologies, if a failure of such components can reasonably be expected to cause the failure of that life-support device or system or to affect the safety or effectiveness of that device or system. Life support devices or systems are intended to be implanted in the human body or to support and/or maintain and sustain and/or protect human life. If they fail, it is reasonable to assume that the health of the user or other persons may be endangered.

Revision History Revision 1.0, 2012-06-30

Page or Item	Subjects (major changes since previous revision)
--------------	--------------------------------------------------

Revision 1.1, 2012-07-03

7	Figure 2-1

Trademarks of Infineon Technologies AG

AURIX™, BlueMoon™, C166™, CanPAK™, CIPOS™, CIPURSE™, COMNEON™, EconoPACK™, CoolMOS™, CoolSET™, CORECONTROL™, CROSSAVE™, DAVE™, EasyPIM™, EconoBRIDGE™, EconoDUAL™, EconoPIM™, EiceDRIVER™, eupec™, FCOS™, HITFET™, HybridPACK™, I²RF™, ISOFACE™, IsoPACK™, MIPAQ™, ModSTACK™, my-d™, NovalithIC™, OmniTune™, OptiMOS™, ORIGA™, PRIMARION™, PrimePACK™, PrimeSTACK™, PRO-SIL™, PROFET™, RASIC™, ReverSave™, SatRIC™, SIEGET™, SINDRION™, SIPMOS™, SMARTi™, SmartLEWIS™, SOLID FLASH™, TEMPFET™, thinQ!™, TRENCHSTOP™, TriCore™, X-GOLD™, X-PMU™, XMM™, XPOSYS™.

Other Trademarks

Advance Design System™ (ADS) of Agilent Technologies, AMBA™, ARM™, MULTI-ICE™, KEIL™, PRIMECELL™, REALVIEW™, THUMB™, μVision™ of ARM Limited, UK. AUTOSAR™ is licensed by AUTOSAR development partnership. Bluetooth™ of Bluetooth SIG Inc. CAT-ig™ of DECT Forum. COLOSSUS™, FirstGPS™ of Trimble Navigation Ltd. EMV™ of EMVCo, LLC (Visa Holdings Inc.). EPCOS™ of Epcos AG. FLEXGO™ of Microsoft Corporation. FlexRay™ is licensed by FlexRay Consortium. HYPERTERMINAL™ of Hilgraeve Incorporated. IEC™ of Commission Electrotechnique Internationale. IrDA™ of Infrared Data Association Corporation. ISO™ of INTERNATIONAL ORGANIZATION FOR STANDARDIZATION. MATLAB™ of MathWorks, Inc. MAXIM™ of Maxim Integrated Products, Inc. MICROTEC™, NUCLEUS™ of Mentor Graphics Corporation. Mifare™ of NXP. MIPI™ of MIPI Alliance, Inc. MIPS™ of MIPS Technologies, Inc., USA. muRata™ of MURATA MANUFACTURING CO., MICROWAVE OFFICE™ (MWO) of Applied Wave Research Inc., OmniVision™ of OmniVision Technologies, Inc. Openwave™ Openwave Systems Inc. RED HAT™ Red Hat, Inc. RFMD™ RF Micro Devices, Inc. SIRIUS™ of Sirius Satellite Radio Inc. SOLARIS™ of Sun Microsystems, Inc. SPANSION™ of Spansion LLC Ltd. Symbian™ of Symbian Software Limited. TAIYO YUDEN™ of Taiyo Yuden Co. TEAKLITE™ of CEVA, Inc. TEKTRONIX™ of Tektronix Inc. TOKO™ of TOKO KABUSHIKI KAISHA TA. UNIX™ of X/Open Company Limited. VERILOG™, PALLADIUM™ of Cadence Design Systems, Inc. VLYNQ™ of Texas Instruments Incorporated. VXWORKS™, WIND RIVER™ of WIND RIVER SYSTEMS, INC. ZETEX™ of Diodes Zetex Limited.

Last Trademarks Update 2010-10-26

1 Uni-directional Ultra-low Capacitance ESD / Transient Protection Array

1.1 Features

- ESD / Transient protection of high speed data lines exceeding:
 - IEC61000-4-2 (ESD): ± 20 kV (air / contact)
 - IEC61000-4-4 (EFT): 2.5 kV / 50 A (5/50 ns)
 - IEC61000-4-5 (surge): 3 A (8/20 μ s)
- Maximum working voltage: $V_R = 5.3$ V
- Very low reverse current: $I_R < 1$ nA typ.
- Extremely low capacitance: 0.4 pF typ. (I/O to GND)
- Four-lines protection array with pad pitch = 0.5 mm
- Flow-through design for optimal PCB layout of differential lines
- Pb-free package (RoHS compliant) and halogen free package



1.2 Application Examples

- Protection of high speed digital interfaces like:
- HDMI 1.3, HDMI 1.4a, MHL, DisplayPort, S-ATA, DVI, MIPI, MDDI
- USB2.0, 10/100/1000 Ethernet, FireWire

2 Product Description

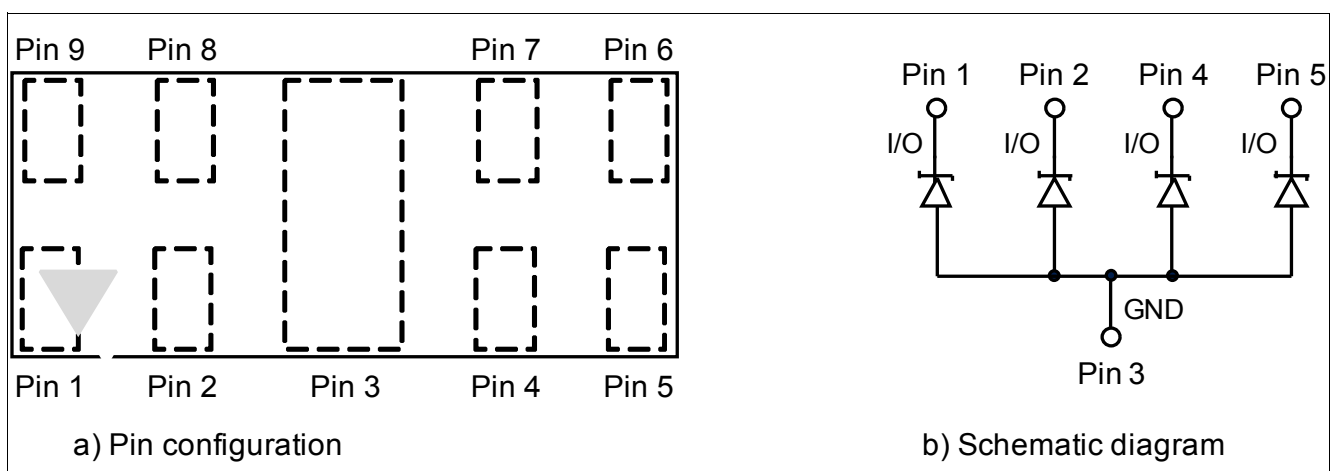

Figure 2-1 Pin Configuration and Schematic Diagram

Table 2-1 Ordering information

Type	Package	Configuration	Marking code
ESD5V3U4U-HDMI	PG-TSLP-9-1	4 lines, uni-directional	Z1

3 Characteristics

Table 3-1 Maximum Rating at $T_A = 25\text{ }^\circ\text{C}$, unless otherwise specified

Parameter	Symbol	Values			Unit
		Min.	Typ.	Max.	
ESD (air / contact) discharge ¹⁾	V_{ESD}	–	–	20	kV
Peak pulse current ($t_p = 8/20\ \mu\text{s}$) ²⁾	I_{PP}	–	–	3	A
Operating temperature range	T_{OP}	-40	–	125	$^\circ\text{C}$
Storage temperature	T_{stg}	-65	–	150	$^\circ\text{C}$

1) V_{ESD} according to IEC61000-4-2

2) I_{PP} according to IEC61000-4-5

3.1 Electrical Characteristics at $T_A = 25\text{ }^\circ\text{C}$, unless otherwise specified

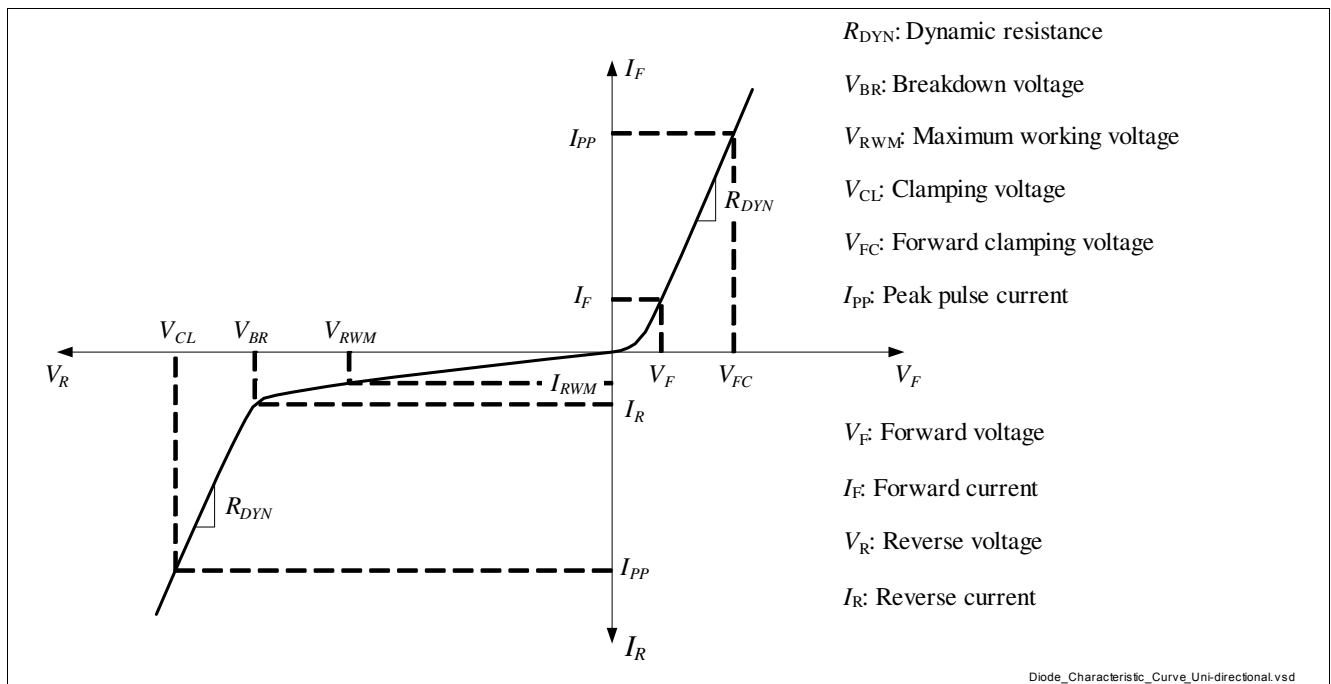

Figure 3-1 Definitions of Electrical Characteristics

Table 3-2 DC Characteristics at $T_A = 25\text{ }^\circ\text{C}$, unless otherwise specified

Parameter	Symbol	Values			Unit	Note / Test Condition
		Min.	Typ.	Max.		
Reverse working voltage	V_{RWM}	–	–	5.3	V	
Breakdown voltage	V_{BR}	6	–	–	V	$I_{BR} = 1\text{ mA}$ (I/O to GND)
Reverse current	I_R	–	<1	50	nA	$V_R = 5.3\text{ V}$ (I/O to GND)

Table 3-3 RF Characteristics at $T_A = 25\text{ }^\circ\text{C}$, unless otherwise specified

Parameter	Symbol	Values			Unit	Note / Test Condition
		Min.	Typ.	Max.		
Line capacitance ¹⁾	C_L	–	0.4	0.6	pF	$V_R = 0\text{ V}$, $f = 1\text{ MHz}$ (I/O to GND)
Line capacitance ¹⁾	C_L	–	0.2	0.3	pF	$V_R = 0\text{ V}$, $f = 1\text{ MHz}$ (I/O to I/O)

1) Total capacitance line to ground

Table 3-4 ESD Characteristics at $T_A = 25\text{ }^\circ\text{C}$, unless otherwise specified

Parameter	Symbol	Values			Unit	Note / Test Condition
		Min.	Typ.	Max.		
Clamping voltage ¹⁾	V_{CL}	–	19	–	V	$I_{PP} = 16\text{ A}$ (I/O to GND)
		–	28	–	V	$I_{PP} = 30\text{ A}$ (I/O to GND)
Forward clamping voltage ¹⁾	V_{FC}	–	10	–	V	$I_{PP} = 16\text{ A}$ (GND to I/O)
		–	17	–	V	$I_{PP} = 30\text{ A}$ (GND to I/O)
Dynamic resistance ¹⁾	R_{DYN}	–	0.6	–	Ω	I/O to GND
		–	0.5	–		GND to I/O

1) Please refer to Application Note AN210 [1]. TLP parameter: $Z_0 = 50\ \Omega$, $t_p = 100\text{ ns}$, $t_r = 300\text{ ps}$, averaging window: $t_1 = 30\text{ ns}$ to $t_2 = 60\text{ ns}$, extraction of dynamic resistance using least squares fit of TLP characteristic between $I_{PP1} = 10\text{ A}$ and $I_{PP2} = 40\text{ A}$.

3.2 Typical Characteristics at $T_A = 25^\circ\text{C}$, unless otherwise specified

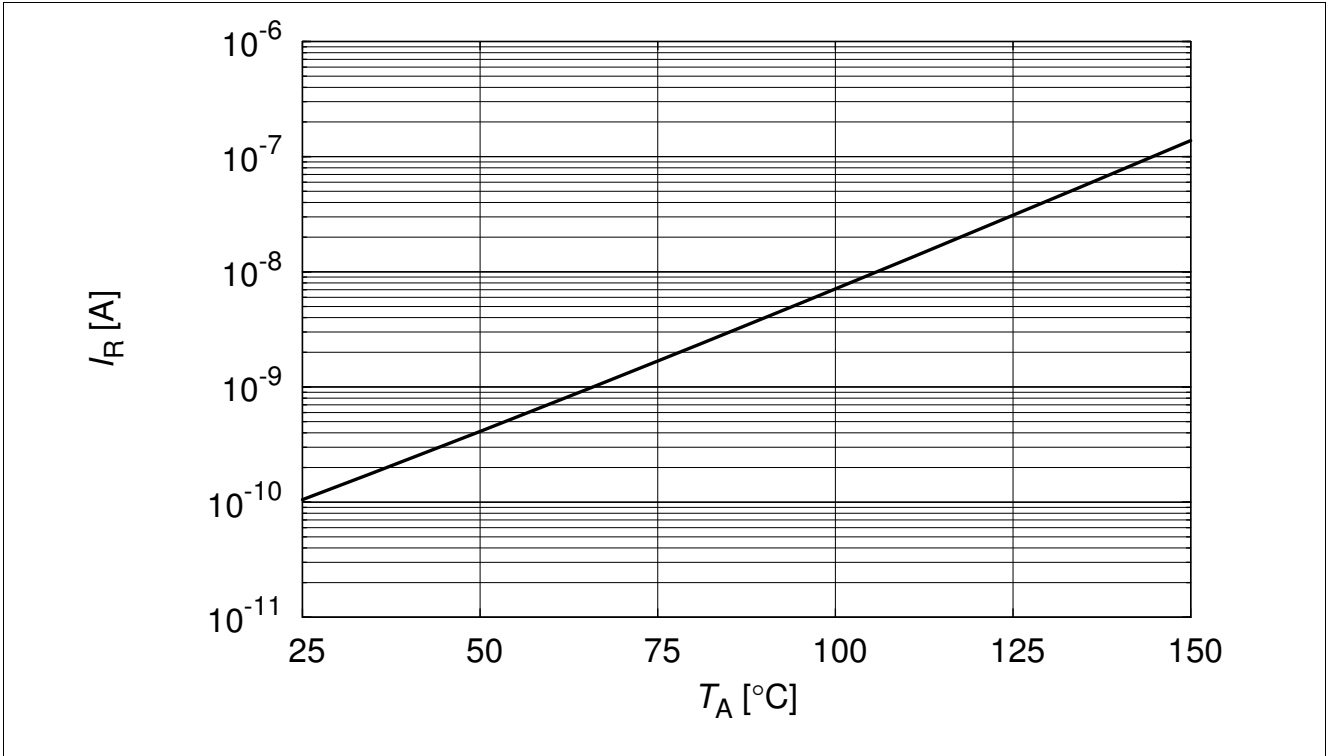

Figure 3-2 Reverse current: $I_R = f(T_A)$, $V_R = 5.3\text{ V}$, (I/O to GND)

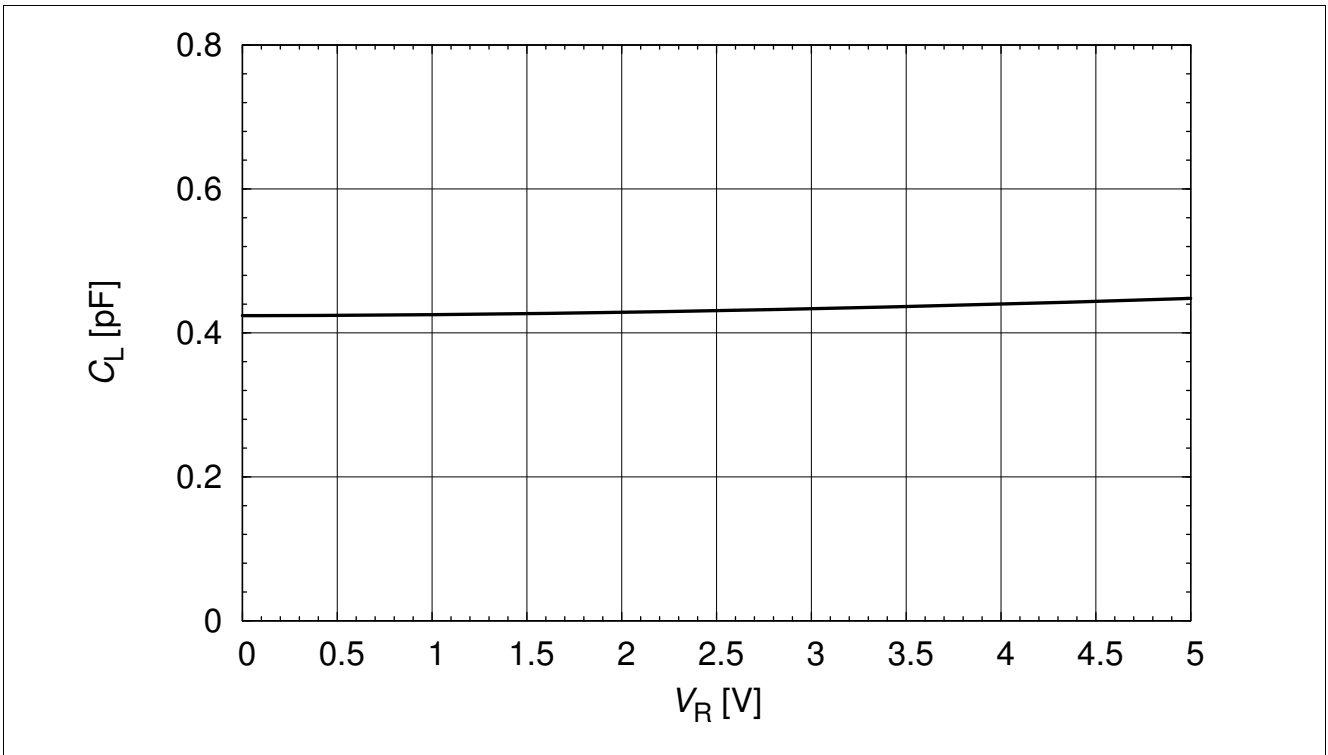

Figure 3-3 Diode capacitance: $C_L = f(V_R)$, (I/O to GND)

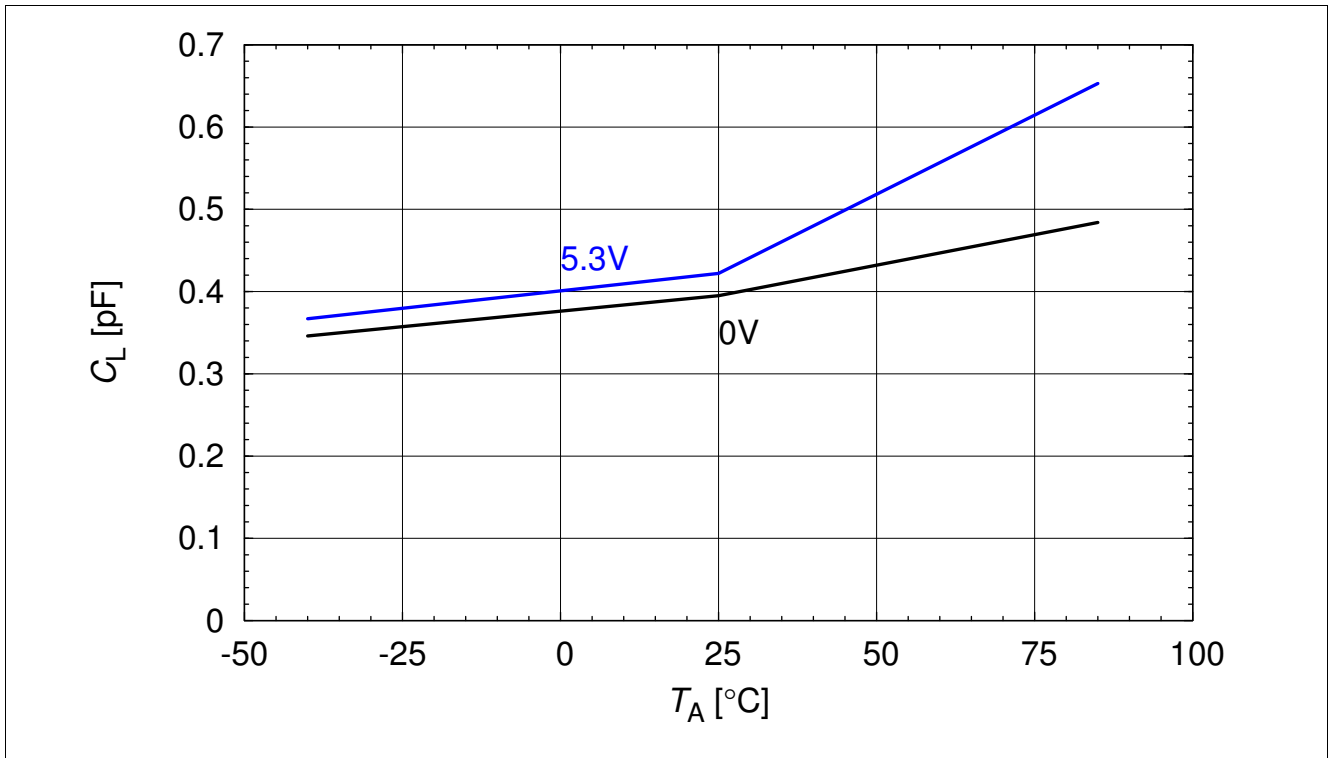

Figure 3-4 Line capacitance: $C_L = f(T_A)$

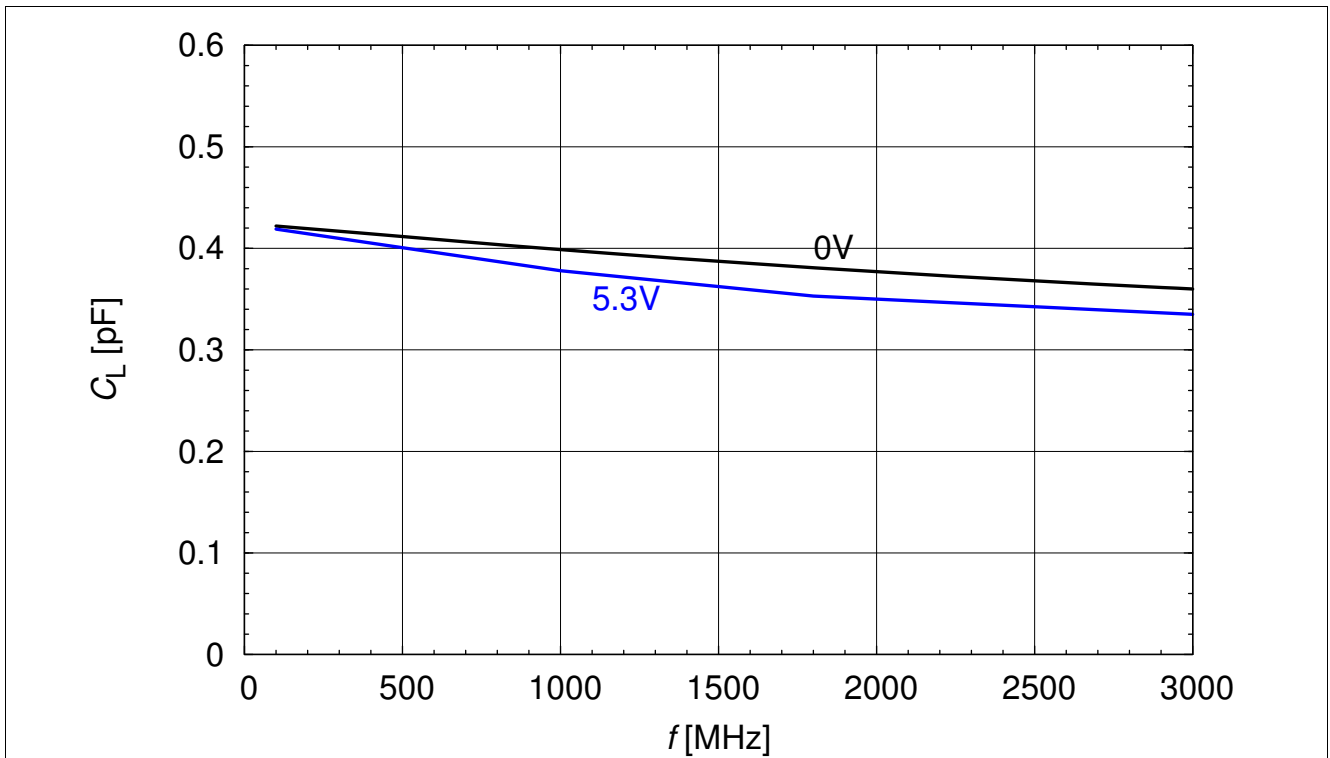

Figure 3-5 Line capacitance: $C_L = f(f)$, (I/O to GND)

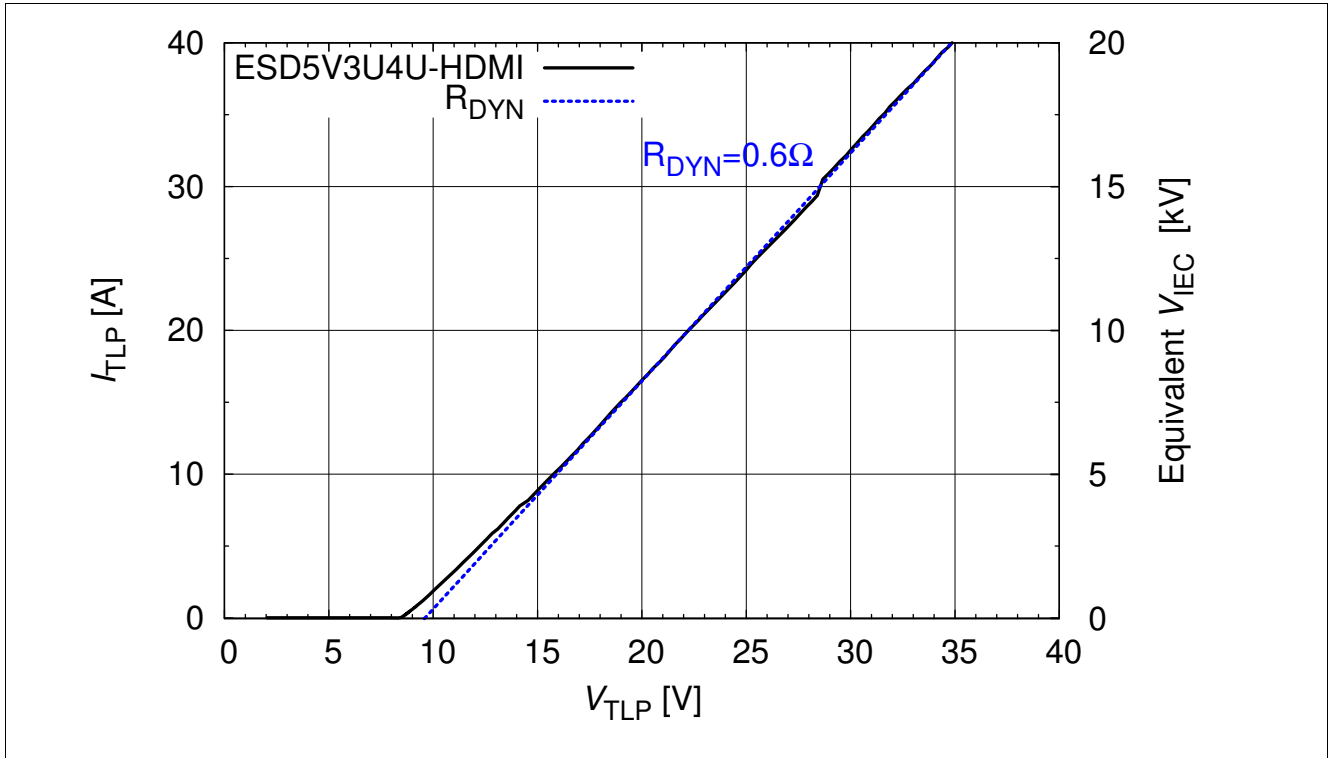

Figure 3-6 Forward clamping voltage: $I_{TLP} = f(V_{TLP})$, (GND to I/O) [1]

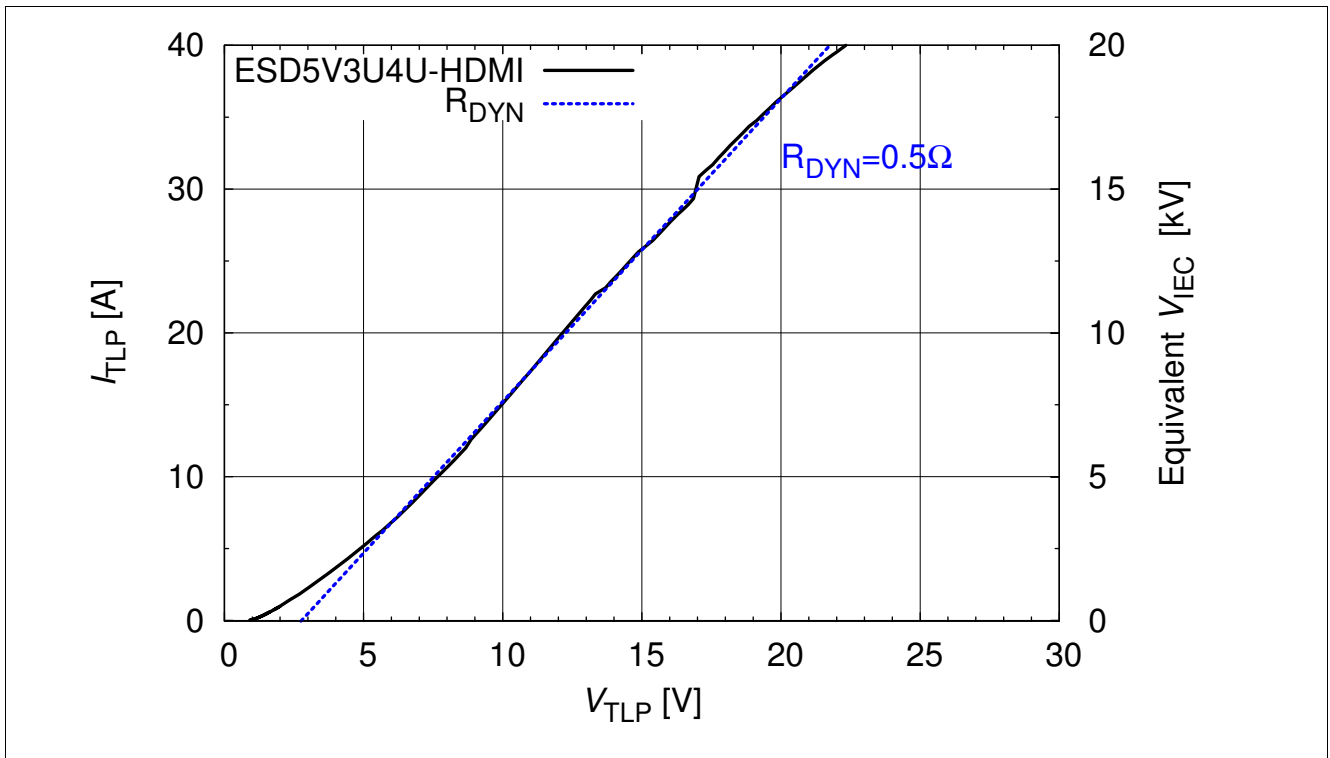

Figure 3-7 Reverse clamping voltage: $I_{TLP} = f(V_{TLP})$, (I/O to GND) [1]

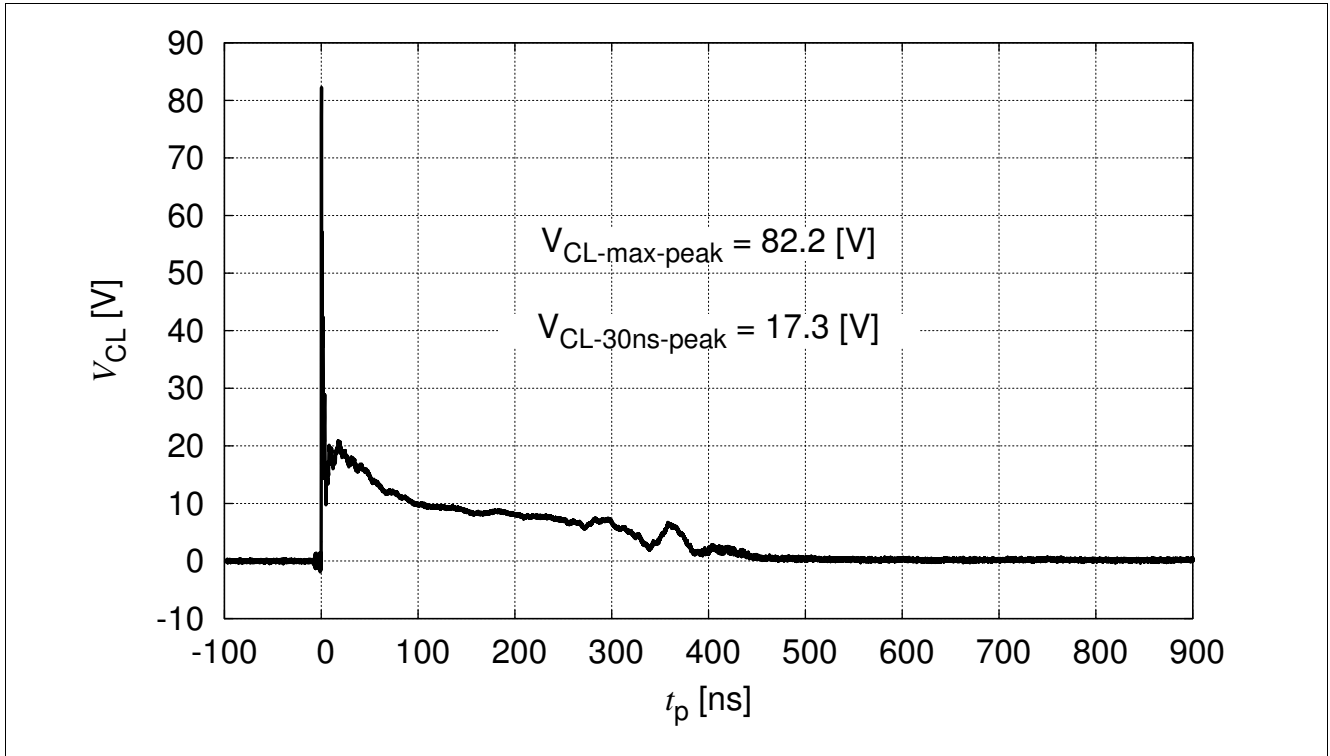

Figure 3-8 IEC61000-4-2 $V_{CL} = f(t)$, 8 kV positive pulse, (I/O to GND)

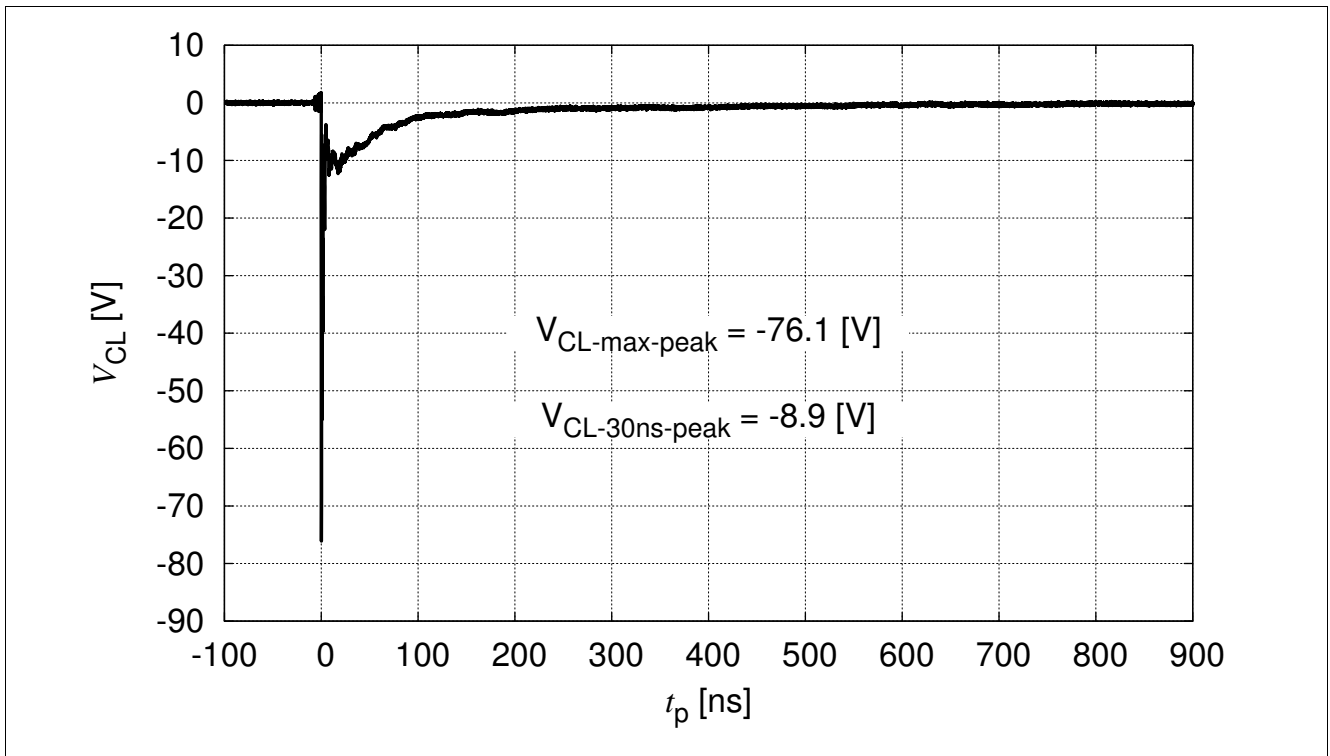

Figure 3-9 IEC61000-4-2 $V_{CL} = f(t)$, 8 kV negative pulse, (I/O to GND)

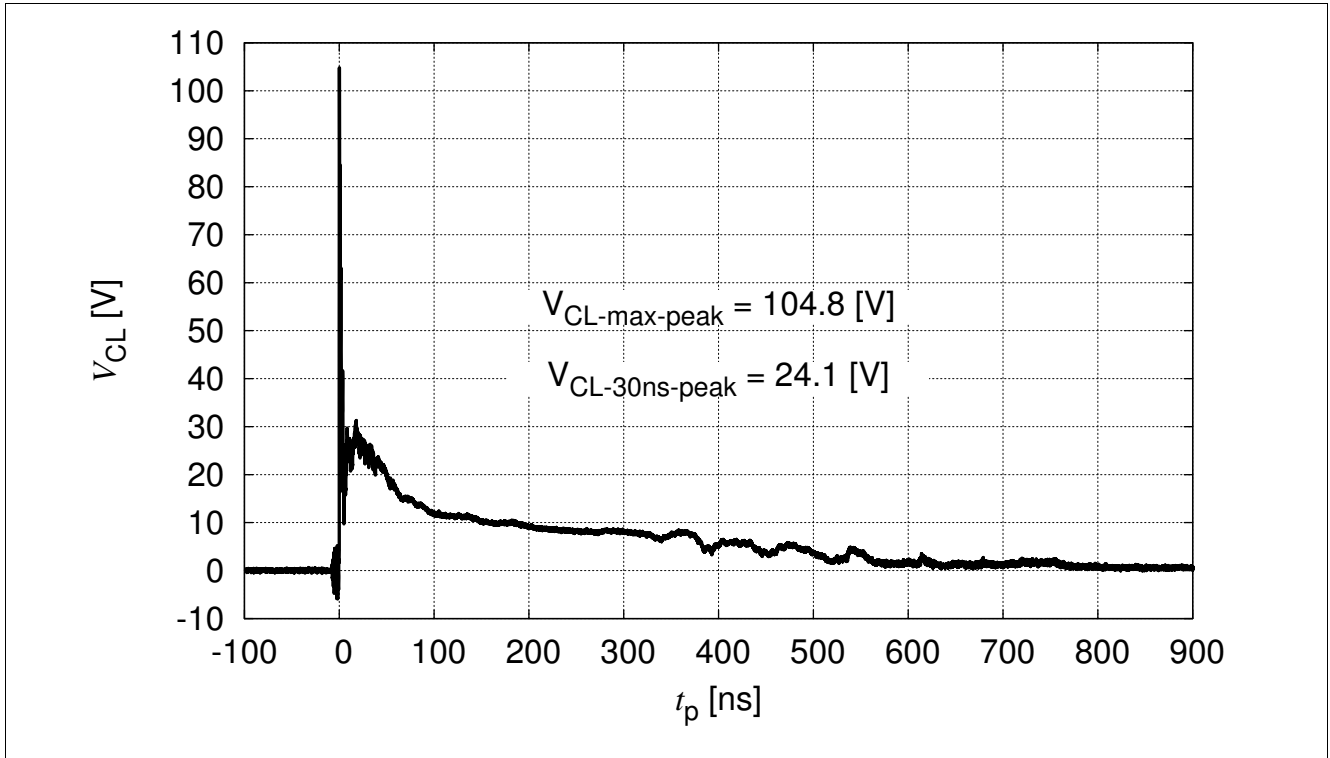

Figure 3-10 IEC61000-4-2 $V_{CL} = f(t)$, 15 kV positive pulse, (I/O to GND)

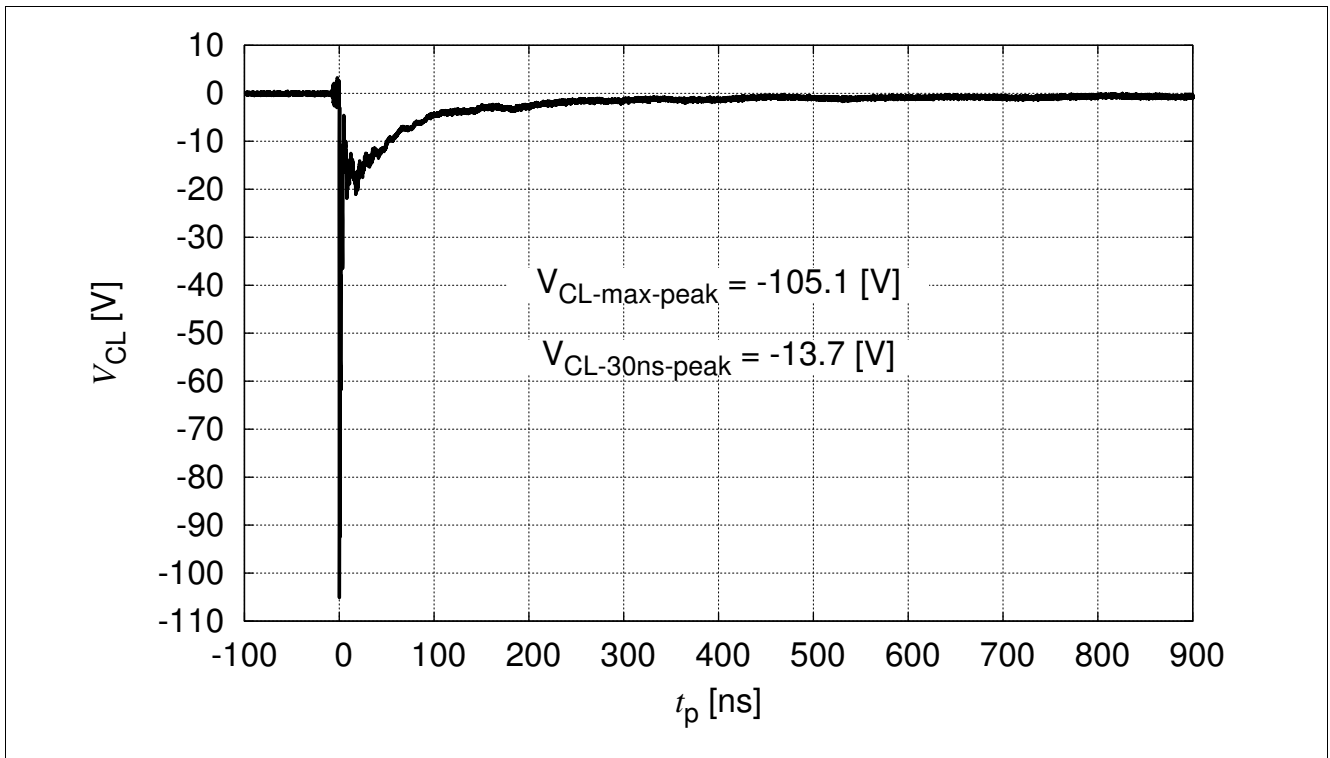

Figure 3-11 IEC61000-4-2 $V_{CL} = f(t)$, 15 kV negative pulse, (I/O to GND)

4 Application Information

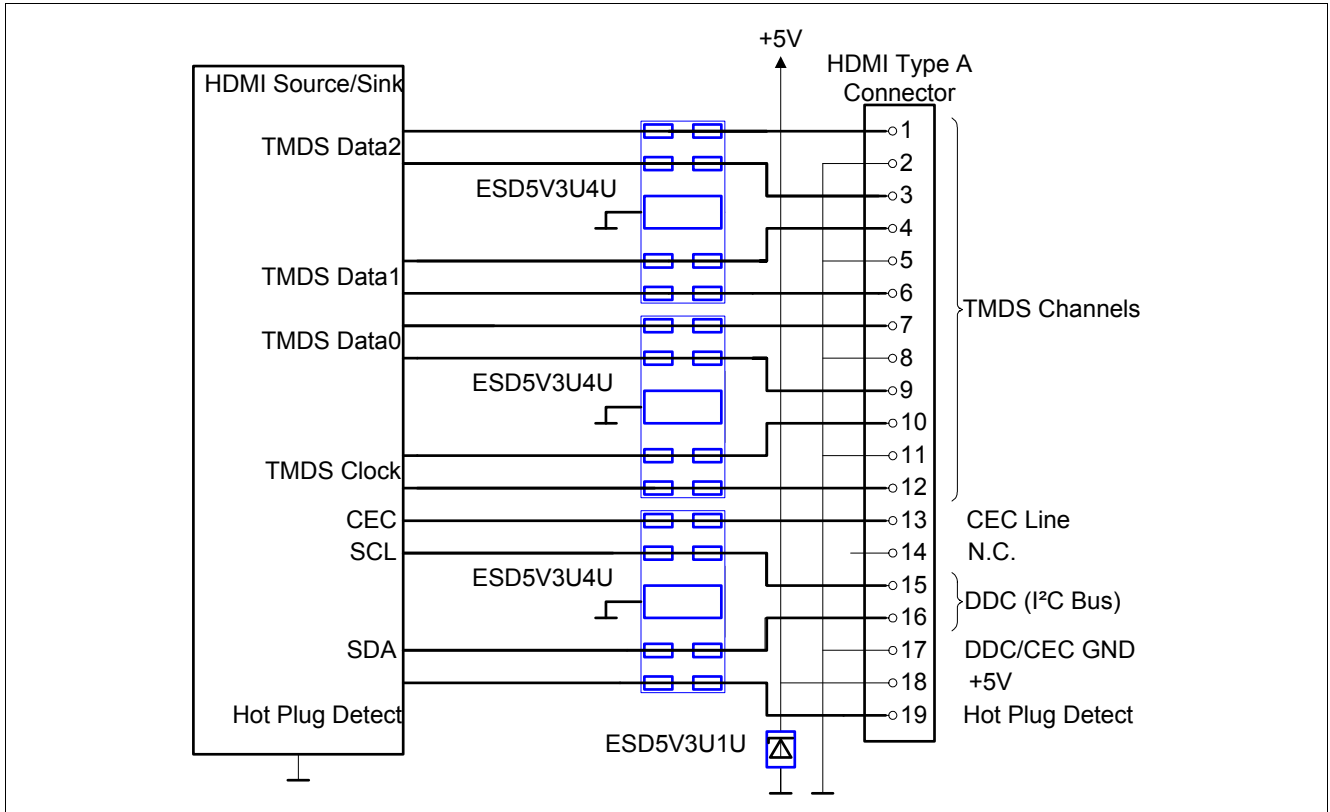

Figure 4-1 4 lines, uni-directional ESD5V3U4U-HDMI

For protection on the 5 V supply rail please refer to ESD5V3U1U- TVS diode data sheet.

5 Ordering Information Scheme (Examples)

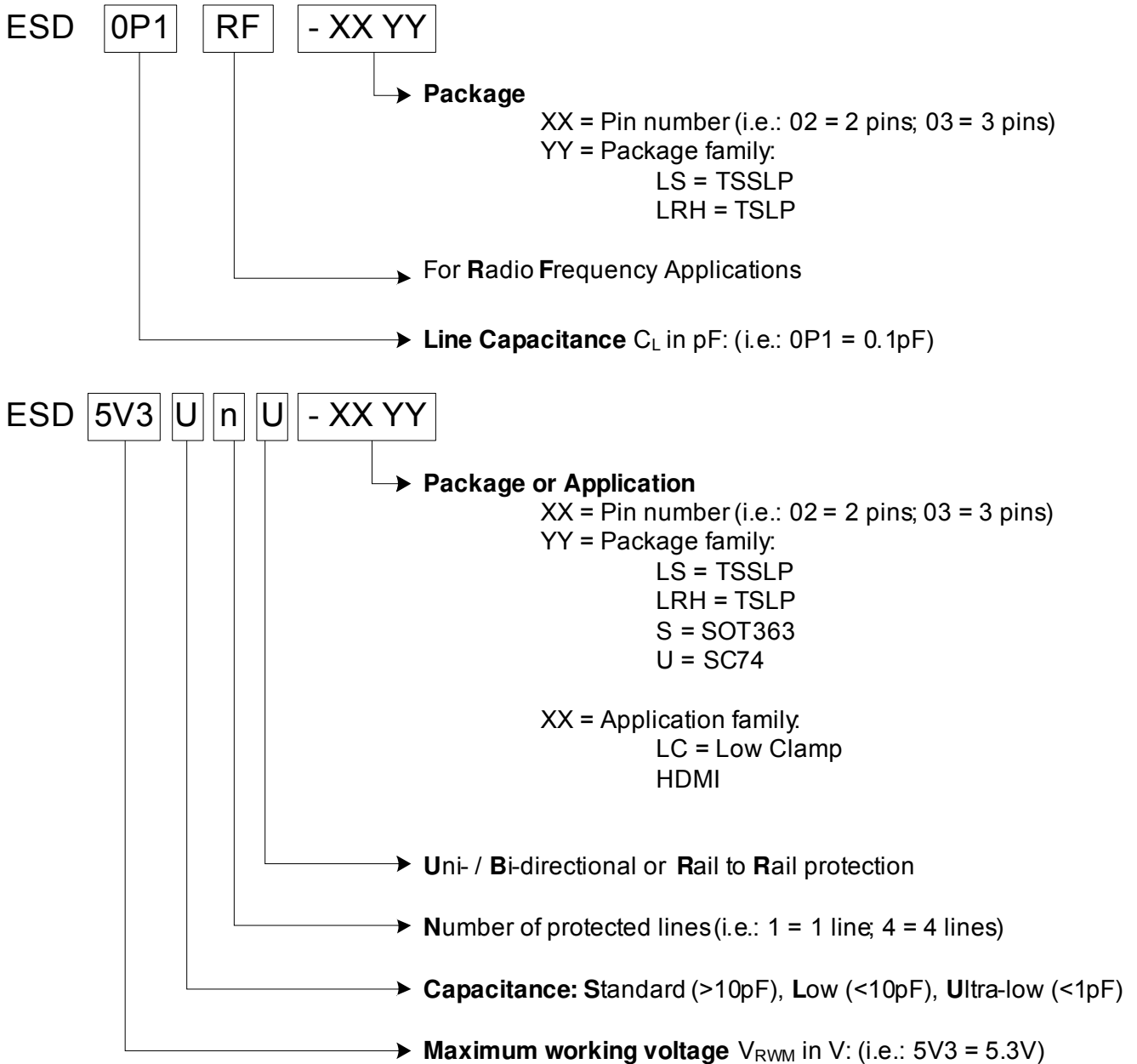

Figure 5-1 Ordering information scheme

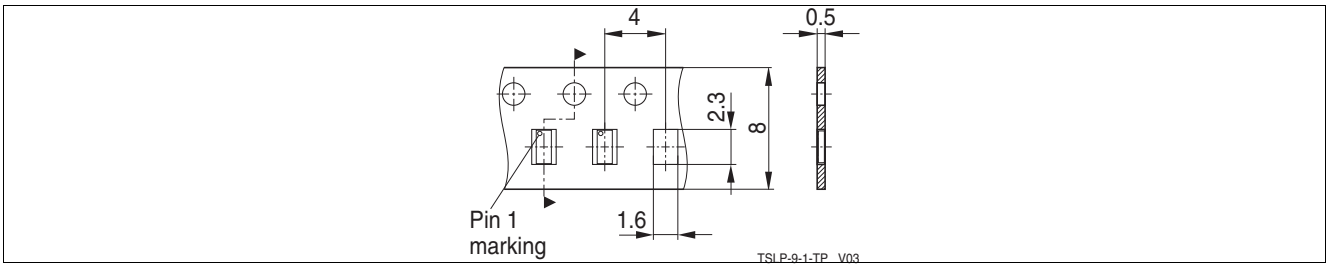

Figure 6-3 PG-TSLP-9-1: Packing

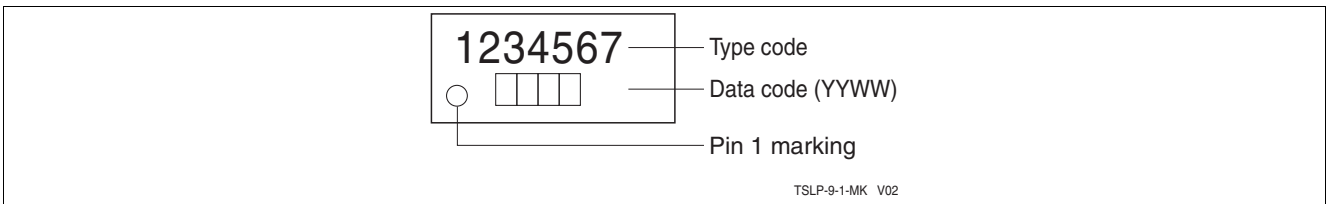

Figure 6-4 PG-TSLP-9-1: Marking (example)

References

- [1] Infineon AG - **Application Note AN210**: Effective ESD Protection Design at System Level Using VF-TLP Characterization Methodology

www.infineon.com

Published by Infineon Technologies AG