



Chipsmall Limited consists of a professional team with an average of over 10 year of expertise in the distribution of electronic components. Based in Hongkong, we have already established firm and mutual-benefit business relationships with customers from,Europe,America and south Asia,supplying obsolete and hard-to-find components to meet their specific needs.

With the principle of "Quality Parts,Customers Priority,Honest Operation,and Considerate Service",our business mainly focus on the distribution of electronic components. Line cards we deal with include Microchip,ALPS,ROHM,Xilinx,Pulse,ON,Everlight and Freescale. Main products comprise IC,Modules,Potentiometer,IC Socket,Relay,Connector.Our parts cover such applications as commercial,industrial, and automotives areas.

We are looking forward to setting up business relationship with you and hope to provide you with the best service and solution. Let us make a better world for our industry!



## Contact us

Tel: +86-755-8981 8866 Fax: +86-755-8427 6832

Email & Skype: info@chipsmall.com Web: www.chipsmall.com

Address: A1208, Overseas Decoration Building, #122 Zhenhua RD., Futian, Shenzhen, China



# ESD9B, SZESD9B

## Transient Voltage Suppressors

### Micro-Packaged Diodes for ESD Protection

The ESD9B Series is designed to protect voltage sensitive components from ESD. Excellent clamping capability, low leakage, and fast response time provide best in class protection on designs that are exposed to ESD. Because of its small size, it is suited for use in cellular phones, MP3 players, digital cameras and many other portable applications where board space comes at a premium.

#### Specification Features

- Low Capacitance 15 pF
- Low Clamping Voltage
- Small Body Outline Dimensions: 0.039" x 0.024" (1.0mm x 0.60mm)
- Low Body Height: 0.016" (0.4 mm)
- Stand-off Voltage: 3.3 V, 5 V
- Low Leakage
- Response Time is < 1 ns
- IEC61000-4-2 Level 4 ESD Protection
- AEC-Q101 Qualified and PPAP Capable
- SZ Prefix for Automotive and Other Applications Requiring Unique Site and Control Change Requirements
- This is a Pb-Free Device

#### Mechanical Characteristics

**CASE:** Void-free, transfer-molded, thermosetting plastic  
Epoxy Meets UL 94 V-0

**LEAD FINISH:** 100% Matte Sn (Tin)

**MOUNTING POSITION:** Any

**QUALIFIED MAX REFLOW TEMPERATURE:** 260°C

Device Meets MSL 1 Requirements

#### MAXIMUM RATINGS

Rating	Symbol	Value	Unit
IEC 61000-4-2 (ESD) Contact Air		±18 ±18	kV
IEC 61000-4-4 (EFT)		40	A
Total Power Dissipation on FR-5 Board (Note 1) @ T <sub>A</sub> = 25°C	P <sub>D</sub>	300	mW
Thermal Resistance, Junction-to-Ambient	R <sub>θJA</sub>	400	°C/W
Junction and Storage Temperature Range	T <sub>J</sub> , T <sub>stg</sub>	-55 to +150	°C
Lead Solder Temperature - Maximum (10 Second Duration)	T <sub>L</sub>	260	°C

Stresses exceeding Maximum Ratings may damage the device. Maximum Ratings are stress ratings only. Functional operation above the Recommended Operating Conditions is not implied. Extended exposure to stresses above the Recommended Operating Conditions may affect device reliability.

1. FR-5 = 1.0 x 0.75 x 0.62 in.



ON Semiconductor®

<http://onsemi.com>



SOD-923  
CASE 514AB

#### MARKING DIAGRAM

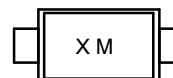

X = Specific Device Code  
M = Date Code

#### ORDERING INFORMATION

Device	Package	Shipping†
ESD9B3.3ST5G	SOD-923 (Pb-Free)	8000/Tape & Reel
ESD9B5.0ST5G	SOD-923 (Pb-Free)	8000/Tape & Reel
SZESD9B5.0ST5G	SOD-923 (Pb-Free)	8000/Tape & Reel

†For information on tape and reel specifications, including part orientation and tape sizes, please refer to our Tape and Reel Packaging Specifications Brochure, BRD8011/D.

# ESD9B, SZESD9B

## ELECTRICAL CHARACTERISTICS

( $T_A = 25^\circ\text{C}$  unless otherwise noted)

Symbol	Parameter
$I_{PP}$	Maximum Reverse Peak Pulse Current
$V_C$	Clamping Voltage @ $I_{PP}$
$V_{RWM}$	Working Peak Reverse Voltage
$I_R$	Maximum Reverse Leakage Current @ $V_{RWM}$
$V_{BR}$	Breakdown Voltage @ $I_T$
$I_T$	Test Current
C	Capacitance @ $V_R = 0\text{ V}$ and $f = 1.0\text{ MHz}$

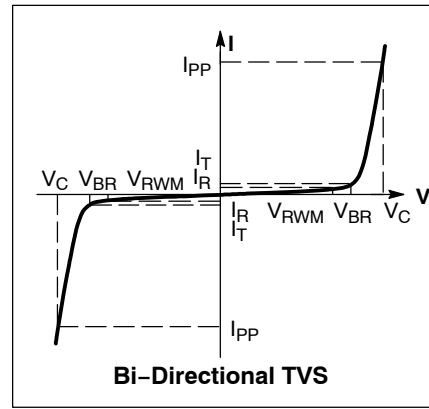

## ELECTRICAL CHARACTERISTICS ( $T_A = 25^\circ\text{C}$ unless otherwise noted)

Device	Device Marking	$V_{RWM}$ (V)	$I_R$ ( $\mu\text{A}$ ) @ $V_{RWM}$	$V_{BR}$ (V) @ $I_T$ (Note 2)		$I_T$ (mA)	C (pF)	$V_C$ (Per IEC61000-4-2 (Note 3))	$V_C$ (V) @ $I_{PP} = 1\text{ A}$ (Max Per 8 x 20 $\mu\text{s}$ (Note 4))
		Max	Max	Min	Max				
ESD9B3.3ST5G	2*	3.3	1.0	5.0	7.0	1.0	15	Figures 1 and 2 See Below	10.5
ESD9B5.0ST5G, SZESD9B5.0ST5G	E	5.0	1.0	5.8	7.8	1.0	15	Figures 1 and 2 See Below	12.5

\* Rotated  $270^\circ$ .

2.  $V_{BR}$  is measured with a pulse test current  $I_T$  at an ambient temperature of  $25^\circ\text{C}$ .

3. For test procedure see Figures 3 and 4 and Application Note AND8307/D.

4. Surge current waveforms per Figure 5.

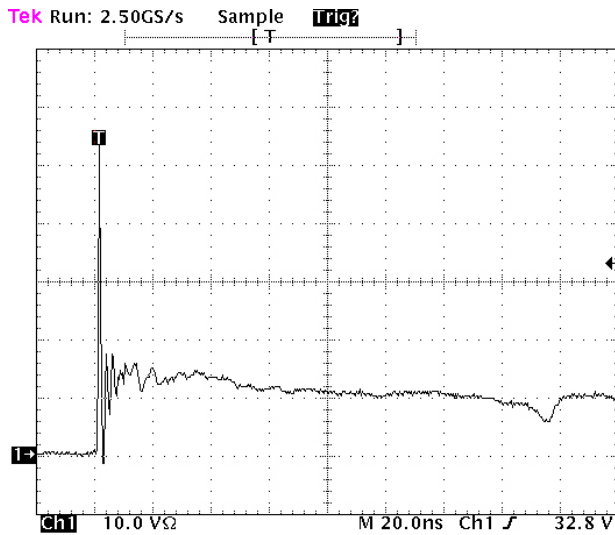

**Figure 1. ESD Clamping Voltage Screenshot Positive 8 kV Contact per IEC61000-4-2**

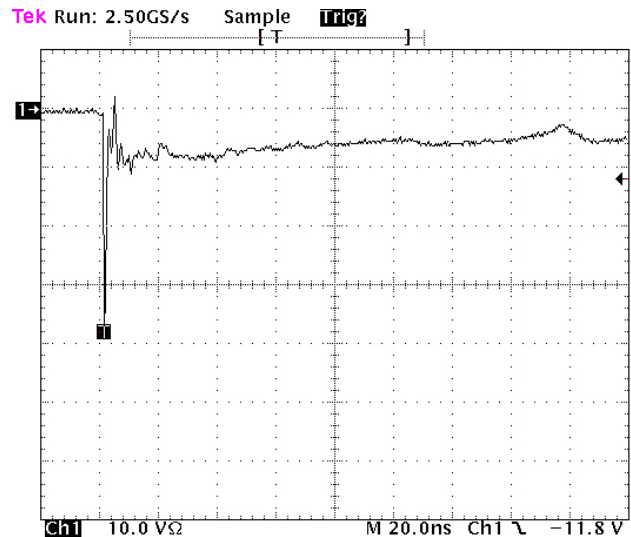

**Figure 2. ESD Clamping Voltage Screenshot Negative 8 kV Contact per IEC61000-4-2**

# ESD9B, SZESD9B

## IEC 61000-4-2 Spec.

Level	Test Voltage (kV)	First Peak Current (A)	Current at 30 ns (A)	Current at 60 ns (A)
1	2	7.5	4	2
2	4	15	8	4
3	6	22.5	12	6
4	8	30	16	8

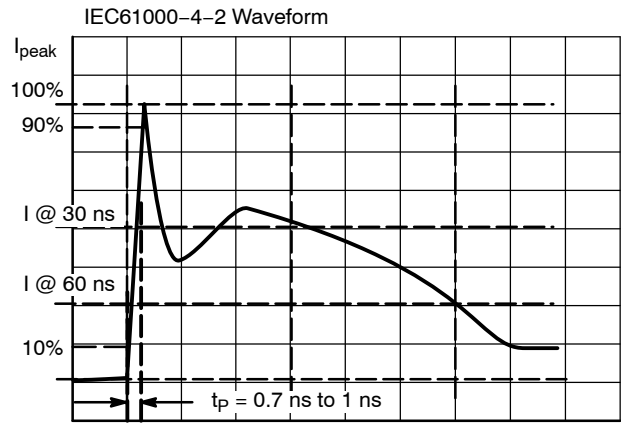

Figure 3. IEC61000-4-2 Spec

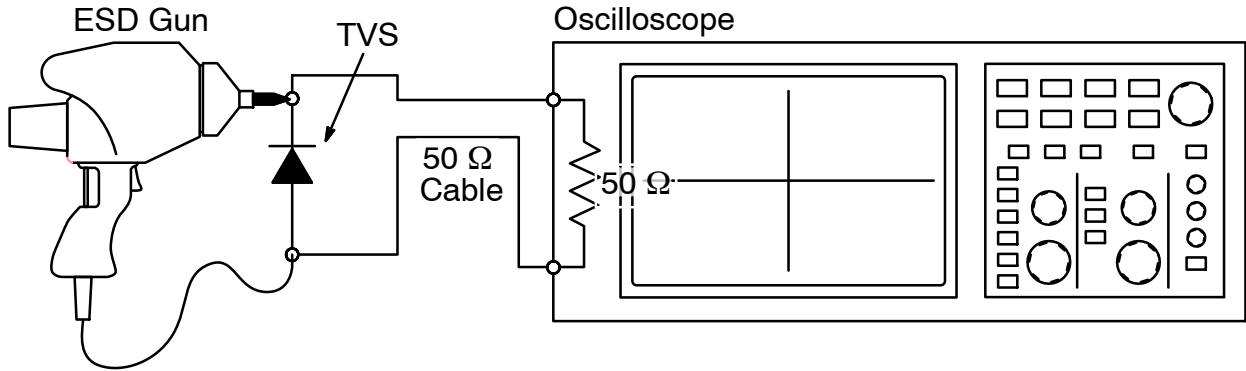

Figure 4. Diagram of ESD Test Setup

The following is taken from Application Note AND8308/D – Interpretation of Datasheet Parameters for ESD Devices.

### ESD Voltage Clamping

For sensitive circuit elements it is important to limit the voltage that an IC will be exposed to during an ESD event to as low a voltage as possible. The ESD clamping voltage is the voltage drop across the ESD protection diode during an ESD event per the IEC61000-4-2 waveform. Since the IEC61000-4-2 was written as a pass/fail spec for larger

systems such as cell phones or laptop computers it is not clearly defined in the spec how to specify a clamping voltage at the device level. ON Semiconductor has developed a way to examine the entire voltage waveform across the ESD protection diode over the time domain of an ESD pulse in the form of an oscilloscope screenshot, which can be found on the datasheets for all ESD protection diodes. For more information on how ON Semiconductor creates these screenshots and how to interpret them please refer to AND8307/D.

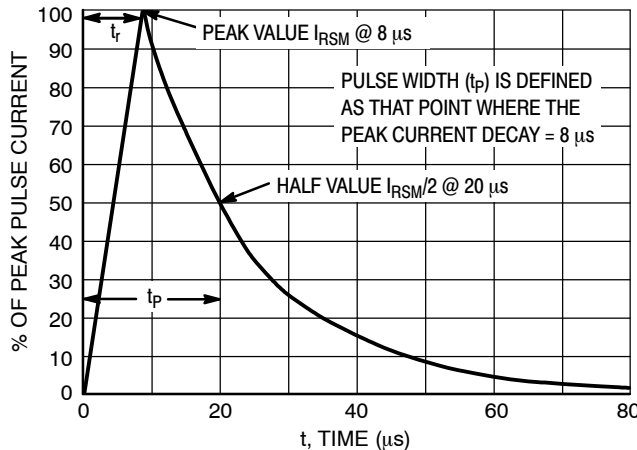

Figure 5. 8 X 20 μs Pulse Waveform



# ESD9B, SZESD9B

## PACKAGE DIMENSIONS

SOD-923  
CASE 514AB-01  
ISSUE B

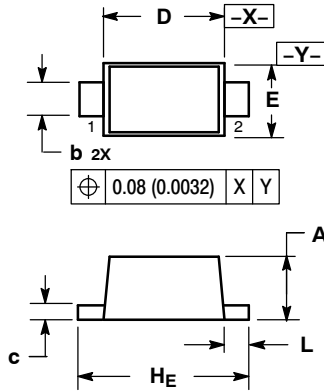

### NOTES:

1. DIMENSIONING AND TOLERANCING PER ANSI Y14.5M, 1982.
2. CONTROLLING DIMENSION: MILLIMETERS.
3. MAXIMUM LEAD THICKNESS INCLUDES LEAD FINISH THICKNESS. MINIMUM LEAD THICKNESS IS THE MINIMUM THICKNESS OF BASE MATERIAL.

DIM	MILLIMETERS			INCHES		
	MIN	NOM	MAX	MIN	NOM	MAX
A	0.34	0.37	0.40	0.013	0.015	0.016
b	0.15	0.20	0.25	0.006	0.008	0.010
c	0.07	0.12	0.17	0.003	0.005	0.007
D	0.75	0.80	0.85	0.030	0.031	0.033
E	0.55	0.60	0.65	0.022	0.024	0.026
H <sub>E</sub>	0.95	1.00	1.05	0.037	0.039	0.041
L	0.05	0.10	0.15	0.002	0.004	0.006

### SOLDERING FOOTPRINT\*

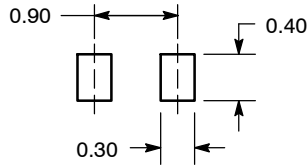

DIMENSIONS: MILLIMETERS

\*For additional information on our Pb-Free strategy and soldering details, please download the ON Semiconductor Soldering and Mounting Techniques Reference Manual, SOLDERRM/D.

ON Semiconductor and  are registered trademarks of Semiconductor Components Industries, LLC (SCILLC). SCILLC reserves the right to make changes without further notice to any products herein. SCILLC makes no warranty, representation or guarantee regarding the suitability of its products for any particular purpose, nor does SCILLC assume any liability arising out of the application or use of any product or circuit, and specifically disclaims any and all liability, including without limitation special, consequential or incidental damages. "Typical" parameters which may be provided in SCILLC data sheets and/or specifications can and do vary in different applications and actual performance may vary over time. All operating parameters, including "Typicals" must be validated for each customer application by customer's technical experts. SCILLC does not convey any license under its patent rights nor the rights of others. SCILLC products are not designed, intended, or authorized for use as components in systems intended for surgical implant into the body, or other applications intended to support or sustain life, or for any other application in which the failure of the SCILLC product could create a situation where personal injury or death may occur. Should Buyer purchase or use SCILLC products for any such unintended or unauthorized application, Buyer shall indemnify and hold SCILLC and its officers, employees, subsidiaries, affiliates, and distributors harmless against all claims, costs, damages, and expenses, and reasonable attorney fees arising out of, directly or indirectly, any claim of personal injury or death associated with such unintended or unauthorized use, even if such claim alleges that SCILLC was negligent regarding the design or manufacture of the part. SCILLC is an Equal Opportunity/Affirmative Action Employer. This literature is subject to all applicable copyright laws and is not for resale in any manner.

### PUBLICATION ORDERING INFORMATION

**LITERATURE FULFILLMENT:**  
Literature Distribution Center for ON Semiconductor  
P.O. Box 5163, Denver, Colorado 80217 USA  
**Phone:** 303-675-2175 or 800-344-3860 Toll Free USA/Canada  
**Fax:** 303-675-2176 or 800-344-3867 Toll Free USA/Canada  
**Email:** orderlit@onsemi.com

**N. American Technical Support:** 800-282-9855 Toll Free  
USA/Canada  
**Europe, Middle East and Africa Technical Support:**  
Phone: 421 33 790 2910  
**Japan Customer Focus Center**  
Phone: 81-3-5817-1050

**ON Semiconductor Website:** [www.onsemi.com](http://www.onsemi.com)

**Order Literature:** <http://www.onsemi.com/orderlit>

For additional information, please contact your local Sales Representative