



Chipsmall Limited consists of a professional team with an average of over 10 year of expertise in the distribution of electronic components. Based in Hongkong, we have already established firm and mutual-benefit business relationships with customers from,Europe,America and south Asia,supplying obsolete and hard-to-find components to meet their specific needs.

With the principle of “Quality Parts,Customers Priority,Honest Operation,and Considerate Service”,our business mainly focus on the distribution of electronic components. Line cards we deal with include Microchip,ALPS,ROHM,Xilinx,Pulse,ON,Everlight and Freescale. Main products comprise IC,Modules,Potentiometer,IC Socket,Relay,Connector.Our parts cover such applications as commercial,industrial, and automotives areas.

We are looking forward to setting up business relationship with you and hope to provide you with the best service and solution. Let us make a better world for our industry!



## Contact us

Tel: +86-755-8981 8866 Fax: +86-755-8427 6832

Email & Skype: info@chipsmall.com Web: www.chipsmall.com

Address: A1208, Overseas Decoration Building, #122 Zhenhua RD., Futian, Shenzhen, China



## Power Choke Coil for Automotive application

Series: **PCC-M0530M-LP(MC)**  
**PCC-M0630M-LP(MC)**  
**PCC-M0840M-LP(MC)**  
**PCC-M1040M-LP(MC)**



High heat resistance and high reliability  
 Using metal composite core (MC)

Industrial Property : patents 3 (Registered 2/Pending 1)

### Features

- High heat resistance : Operation up to 155 °C including self-heating
- Low profile : 3 mm max. height (PCC-M0530M-LP, PCC-M0630M-LP)  
4 mm max. height (PCC-M0840M-LP, PCC-M1040M-LP)
- SMD type
- High-reliability : High vibration resistance as result of newly developed integral construction; under severe reliability conditions of automotive and other strenuous applications
- High bias current : Excellent inductance stability using ferrous alloy magnetic material (Fig.1)
- Temp. stability : Excellent inductance stability over broad temp. range
- Low audible (buzz) noise : New metal composite core technology
- High efficiency : Low  $R_{DC}$  of winding and low eddy-current loss of the core
- Shielded construction
- AEC-Q200 Automotive qualified
- RoHS compliant

● Fig.1 Inductance v.s. DC current

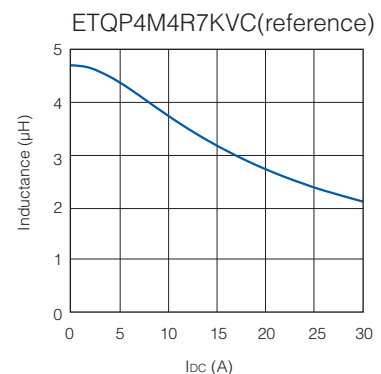

### Recommended Applications

- Noise filter for various drive circuitry requiring high temp. operation and peak current handling capability
- Boost-Converter, Buck-Converter DC/DC

### Standard Packing Quantity (Minimum Quantity/Packing Unit)

- 4,000 pcs./box (2 reel) : PCC-M0530M-LP, PCC-M0630M-LP
- 1,000 pcs./box (2 reel) : PCC-M0840M-LP, PCC-M1040M-LP

### Explanation of Part Numbers

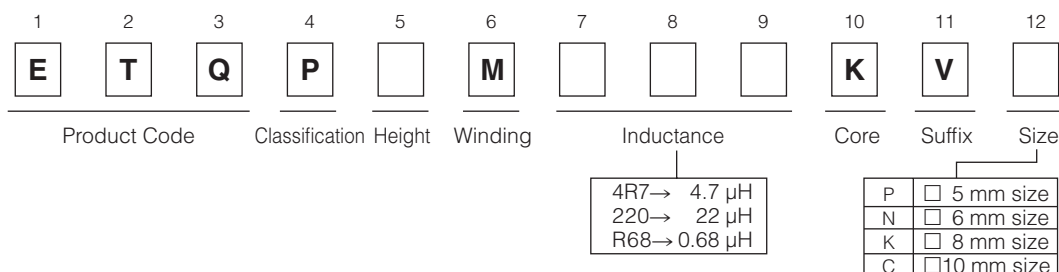

### Temperature rating

Operating temperature range		Tc : -55 °C to +155 °C(Including self-temperature rise)
Storage condition	After PWB mounting	
	Before PWB mounting	Ta : -5 °C to +35 °C 85%RH max.

## 1. Series PCC-M0530M-LP (ETQP3M□□□KVP)

### Standard Parts

Series	Part No.	Inductance *1		DCR (at 20 °C) (mΩ)		Rated Current (Typ. : A)		
		L0 (μH)	Tolerance (%)	Typ. (max.)	Tolerance (%)	ΔT=40K		ΔL=-30%
						(*2)	(*3)	(*4)
PCC-M0530M-LP [5.5×5.0×3.0(mm)]	ETQP3M100KVP	10.00	±20	96 (105.6)	±10	2.4	2.9	4.2
	ETQP3M6R8KVP	6.80		65.7 (72.27)		2.9	3.5	6.1
	ETQP3M4R7KVP	4.70		45.6 (50.16)		3.4	4.1	6.7
	ETQP3M3R3KVP	3.30		27.3 (30.03)		4.4	5.4	8.0
	ETQP3M2R2KVP	2.20		20 (22)		5.2	6.3	10.1
	ETQP3M1R5KVP	1.50		12 (13.2)		6.7	8.1	12.0
	ETQP3M1R0KVP	1.00		9.6 (10.56)		7.5	9.0	14.1
	ETQP3MR68KVP	0.68		7.6 (8.36)		8.4	10.2	15.9

(\*1) Measured at 100k Hz.

(\*2) DC current which causes temperature rise of 40K. Parts are soldered by reflow on four-layer PWB (1.6 mm FR4) and measured at room temperature. See also (\*5)

(\*3) DC current which causes temperature rise of 40K. Parts are soldered by reflow on multilayer PWB with high heat dissipation performance. Note: Heat radiation constant are approx. 51 K/W measured on 5.5×5.0×3.0 mm case size. See also (\*5)

(\*4) Saturation rated current : DC current which causes L(0) drop -30 %.

(\*5) Within a suitable application, the part's temperature depends on circuit design and certain heat dissipation conditions. This should be double checked in a worst case operation mode.

In normal case, the max.standard operating temperature of +155 °C should not be exceeded.

For higher operating temperature conditions, please contact Panasonic representative in your area.

### Performance Characteristics (Reference)

#### ● Inductance vs DC Current

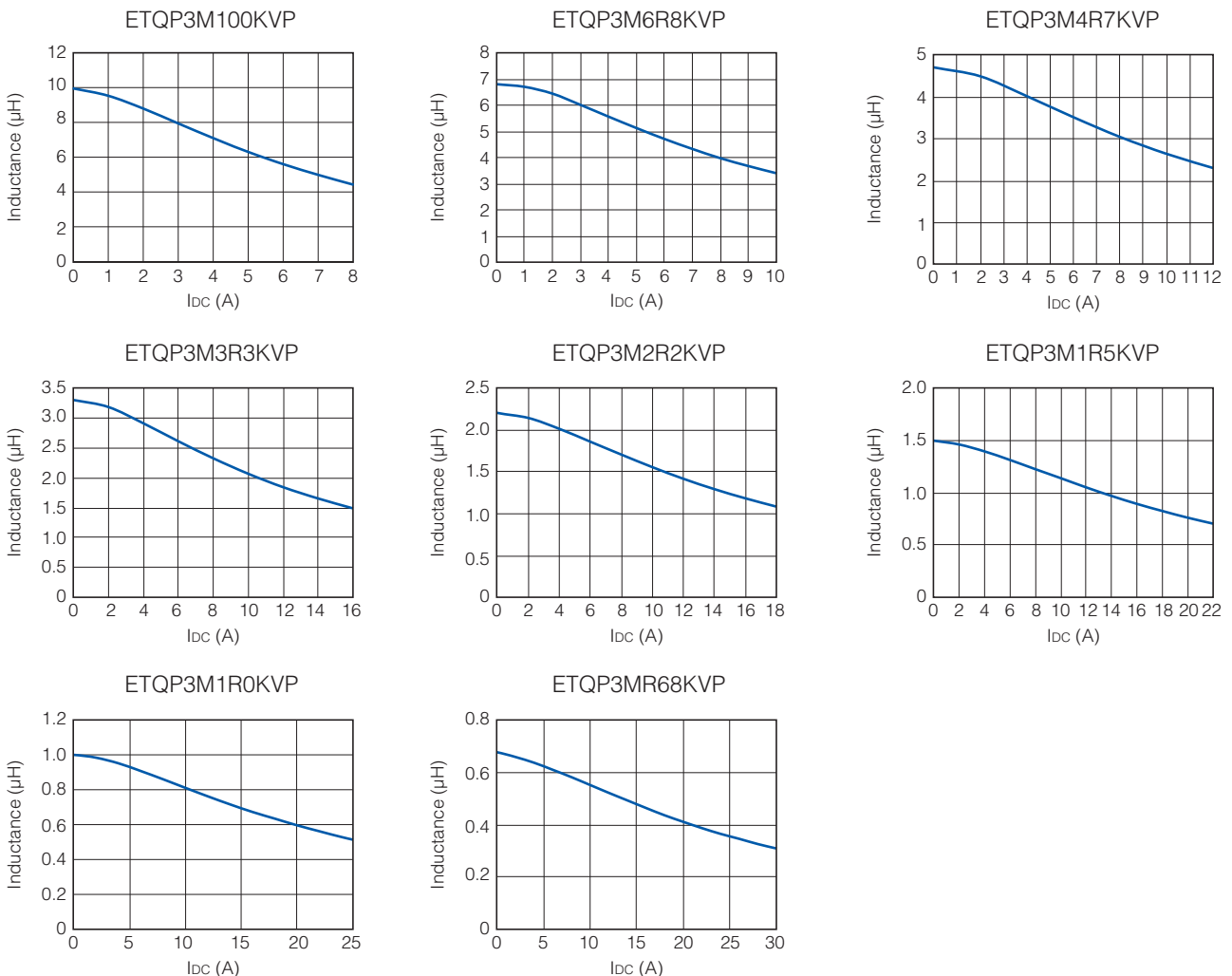



## Performance Characteristics (Reference)

### ● Case Temperature vs DC Current

PWB condition A : Four-layer PWB (1.6 mm FR4), See also (\*2)

PWB condition B : Multilayer PWB with high heat dissipation performance. See also (\*3)

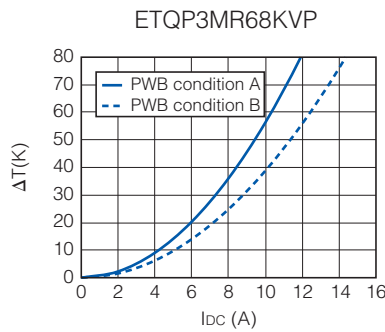
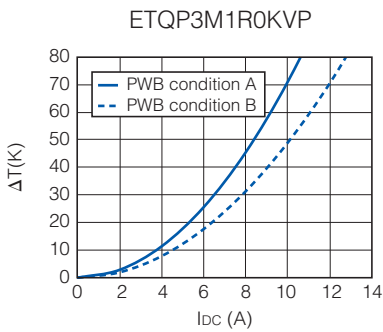
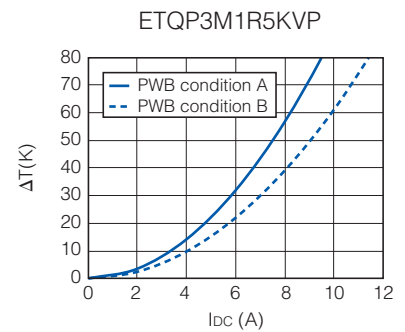
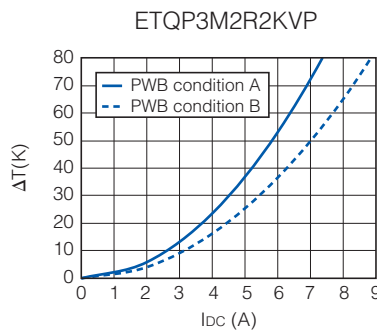
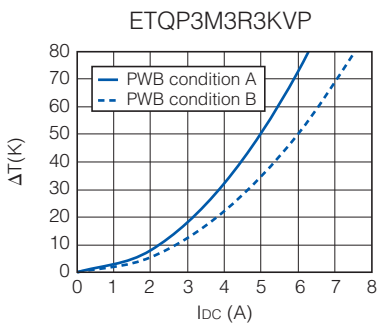
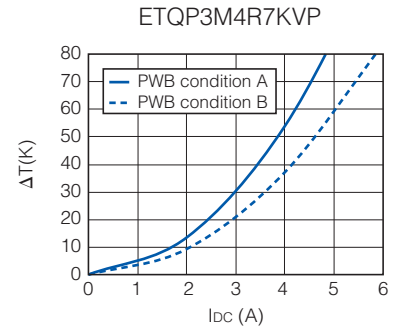
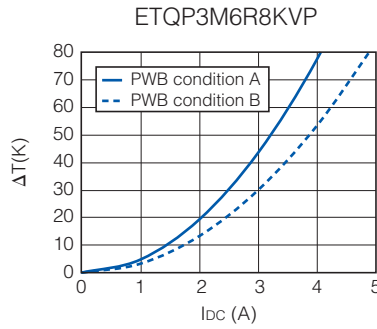
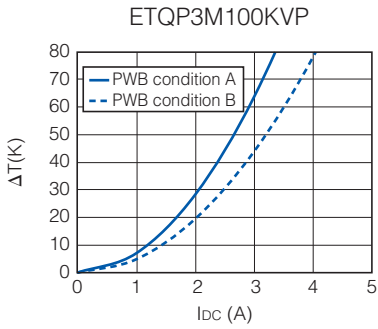

## 2. Series PCC-M0630M-LP (ETQP3M□□□KVN)

### Standard Parts

Series	Part No.	Inductance *1		DCR (at 20 °C) (mΩ)		Rated Current (Typ. : A)		
		L0 (μH)	Tolerance (%)	Typ. (max.)	Tolerance (%)	ΔT=40K		ΔL=-30%
						(*2)	(*3)	(*4)
PCC-M0630M-LP [6.4×6.0×3.0(mm)]	ETQP3M330KVN	33.00	±20	206 (226.6)	±10	1.7	2.1	3.0
	ETQP3M220KVN	22.00		128 (140.8)		2.2	2.7	4.3
	ETQP3M150KVN	15.00		99.2 (109.12)		2.5	3.0	5.1
	ETQP3M100KVN	10.00		71 (78.1)		2.9	3.6	5.8
	ETQP3M6R8KVN	6.80		45.6 (50.16)		3.6	4.5	8.1
	ETQP3M4R7KVN	4.70		29 (31.9)		4.6	5.6	9.8
	ETQP3M3R3KVN	3.30		24.1 (26.51)		5.0	6.1	11.5
	ETQP3M2R2KVN	2.20		14.5 (15.95)		6.5	7.9	12.8
	ETQP3M1R5KVN	1.50		11 (12.1)		7.4	9.1	14.2
	ETQP3M1R0KVN	1.00		6.2 (6.82)		9.9	12.1	16.0
ETQP3MR68KVN	0.68	5.2 (5.72)	10.8	13.2	20.2			

(\*1) Measured at 100k Hz.

(\*2) DC current which causes temperature rise of 40K. Parts are soldered by reflow on four-layer PWB (1.6 mm FR4) and measured at room temperature. See also (\*5)

(\*3) DC current which causes temperature rise of 40K. Parts are soldered by reflow on multilayer PWB with high heat dissipation performance. Note: Heat radiation constant are approx. 44 K/W measured on 6.5×6.0×3.0 mm case size. See also (\*5)

(\*4) Saturation rated current : DC current which causes L(0) drop -30 %.

(\*5) Within a suitable application, the part's temperature depends on circuit design and certain heat dissipation conditions. This should be double checked in a worst case operation mode.

In normal case, the max.standard operating temperature of +155 °C should not be exceeded.

For higher operating temperature conditions, please contact Panasonic representative in your area.

### Performance Characteristics (Reference)

#### ● Inductance vs DC Current

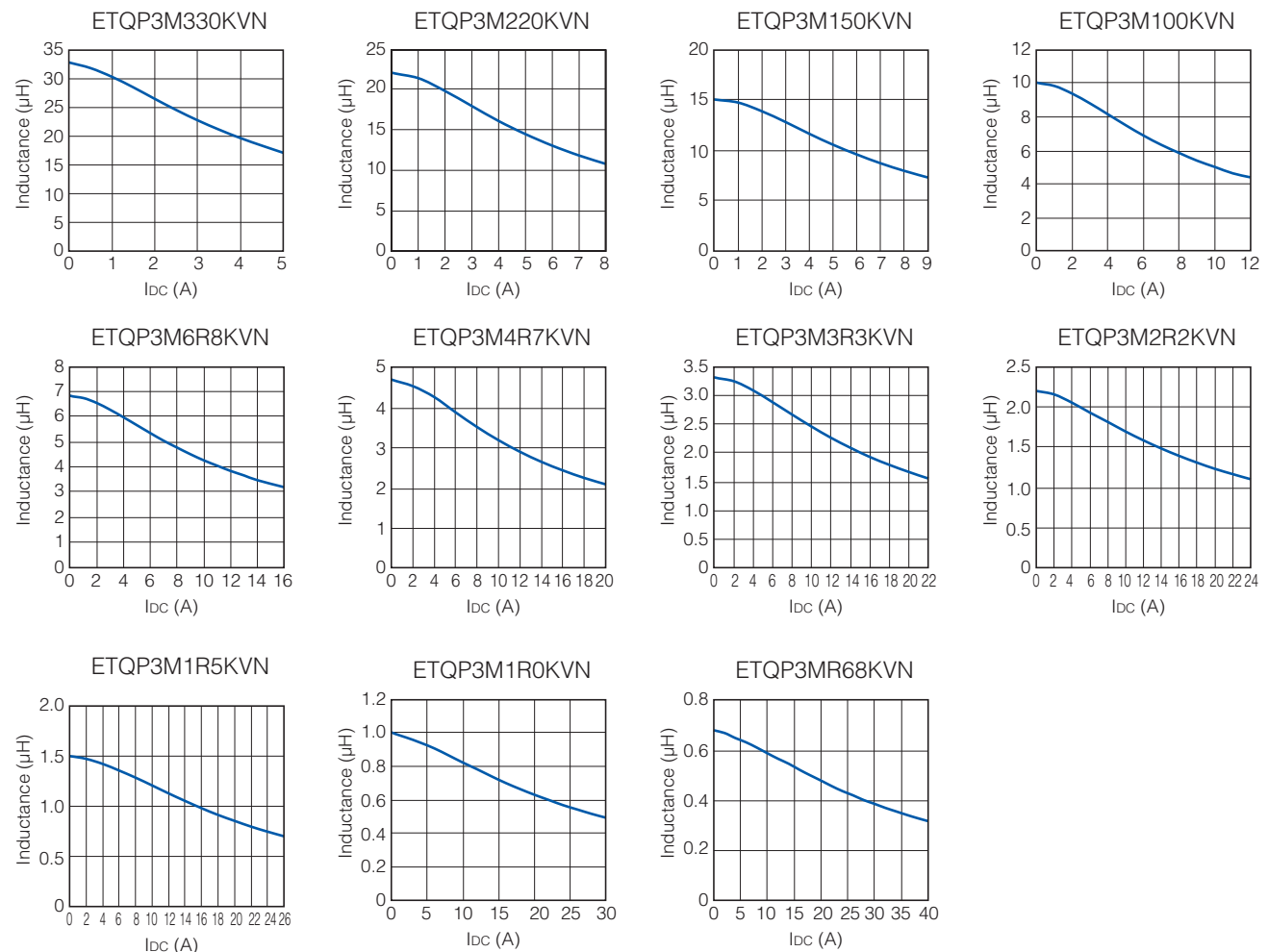

## Performance Characteristics (Reference)

### ● Case Temperature vs DC Current

PWB condition A : Four-layer PWB (1.6 mm FR4), See also (\*2)

PWB condition B : Multilayer PWB with high heat dissipation performance. See also (\*3)

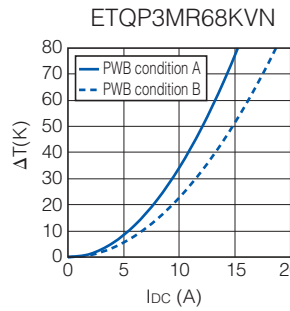
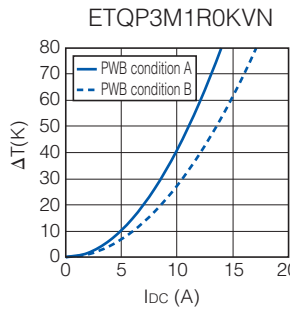
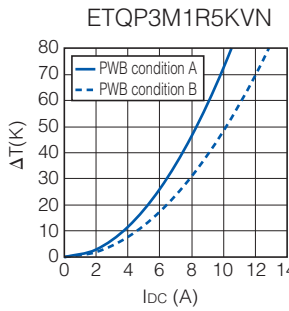
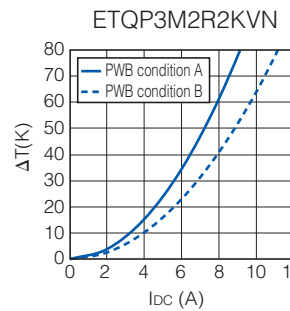
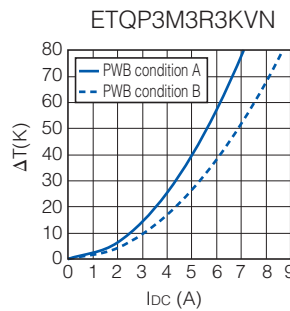
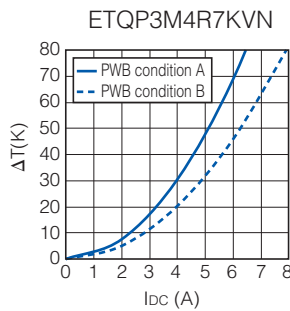
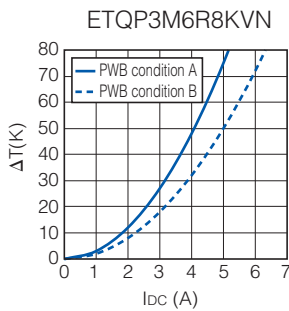
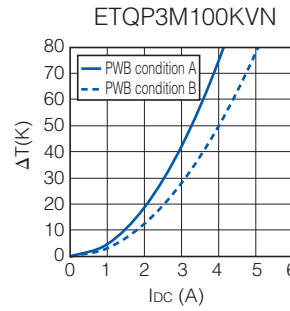
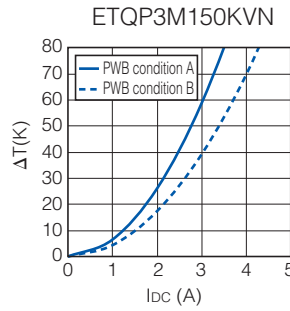
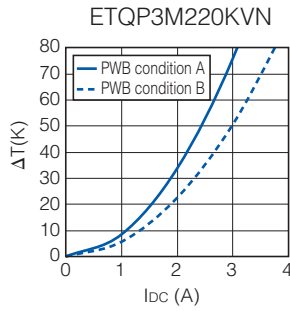
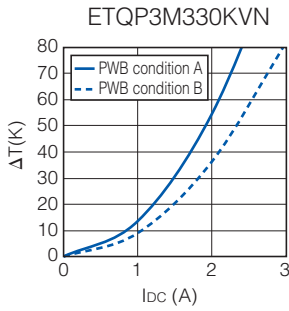

### 3. Series PCC-M0840M-LP (ETQP4M□□□KVK)

#### Standard Parts

Series	Part No.	Inductance *1		DCR (at 20 °C) (mΩ)		Rated Current (Typ. : A)		
		L0 (μH)	Tolerance (%)	Typ. (max.)	Tolerance (%)	ΔT=40K		ΔL=-30%
						(*2)	(*3)	(*4)
PCC-M0840M-LP [8.5×8.0×4.0(mm)]	▲ETQP4M330KVK	33.00	±20	118 (129.8)	±10	2.6	3.1	5.3
	▲ETQP4M220KVK	22.00		76.3 (83.93)		3.3	3.8	6.7
	▲ETQP4M150KVK	15.00		55 (60.5)		3.8	4.5	7.7
	▲ETQP4M100KVK	10.00		41.6 (45.76)		4.4	5.2	9.1
	▲ETQP4M6R8KVK	6.80		23.5 (25.85)		5.9	6.9	11.0
	ETQP4M4R7KVK	4.70		16.1 (17.71)		7.1	8.3	15.1
	▲ETQP4M3R3KVK	3.30		14 (15.4)		7.6	8.9	17.4
	▲ETQP4M2R2KVK	2.20		8.5 (9.35)		9.8	11.4	20.4
	▲ETQP4M1R5KVK	1.50		4.9 (5.39)		12.8	15.1	22.5
	▲ETQP4M1R0KVK	1.00		3.7 (4.07)		14.8	17.3	24.4
▲ETQP4MR68KVK	0.68	2.9 (3.19)	16.7	19.6	29.0			

(\*1) Measured at 100k Hz.

(\*2) DC current which causes temperature rise of 40K. Parts are soldered by reflow on four-layer PWB (1.6 mm FR4) and measured at room temperature. See also (\*5)

(\*3) DC current which causes temperature rise of 40K. Parts are soldered by reflow on multilayer PWB with high heat dissipation performance. Note: Heat radiation constant are approx. 36 K/W measured on 8.5×8.0×4.0 mm case size. See also (\*5)

(\*4) Saturation rated current : DC current which causes L(0) drop -30 %.

(\*5) Within a suitable application, the part's temperature depends on circuit design and certain heat dissipation conditions. This should be double checked in a worst case operation mode.

In normal case, the max.standard operating temperature of +155 °C should not be exceeded.

For higher operating temperature conditions, please contact Panasonic representative in your area.

▲ Under development (Start of mass production: the 2nd half of 2017) Please contact us for customized part no.

#### Performance Characteristics (Reference)

##### ● Inductance vs DC Current

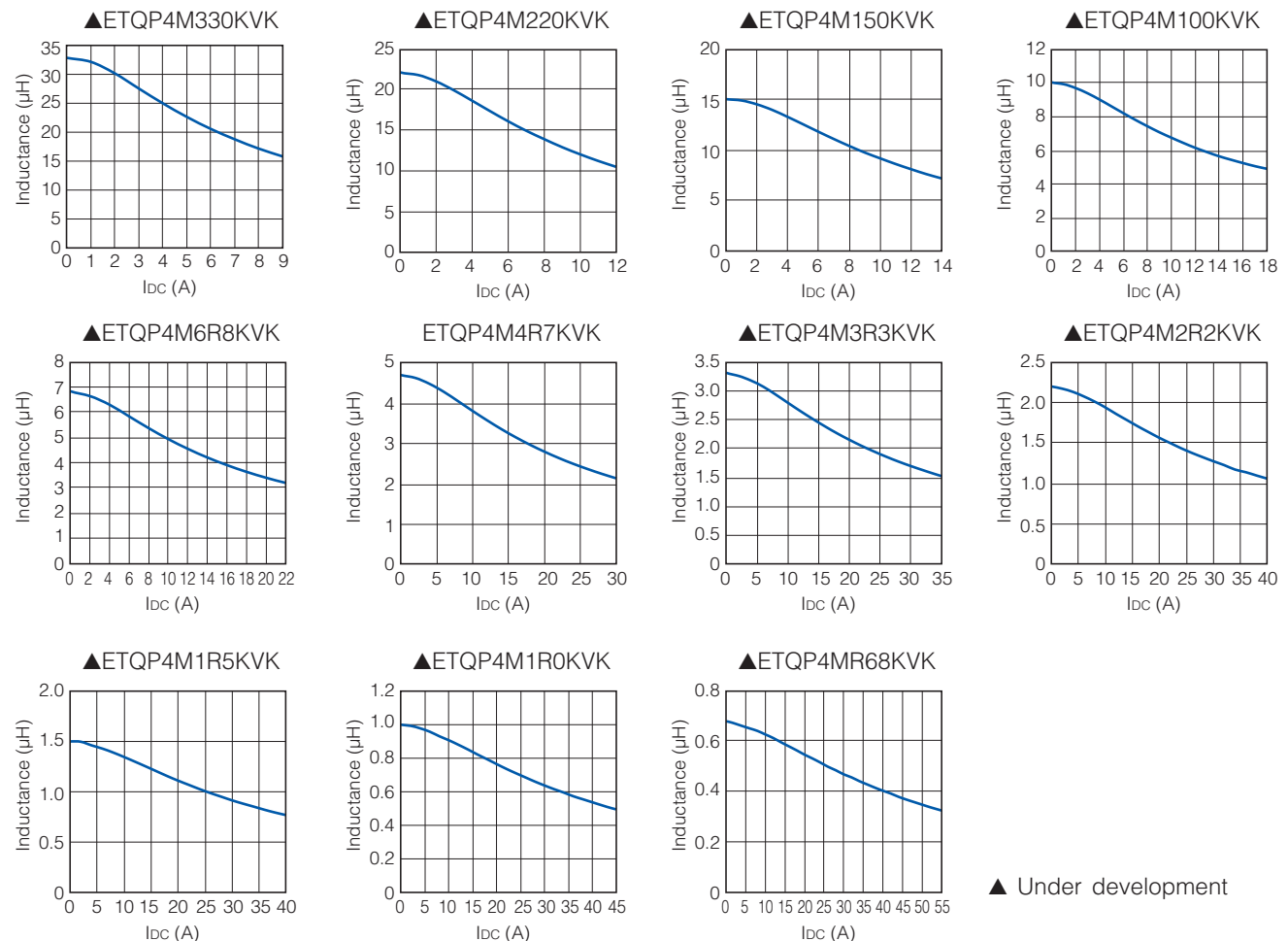

## Performance Characteristics (Reference)

### ● Case Temperature vs DC Current

PWB condition A : Four-layer PWB (1.6 mm FR4), See also (\*2)

PWB condition B : Multilayer PWB with high heat dissipation performance. See also (\*3)

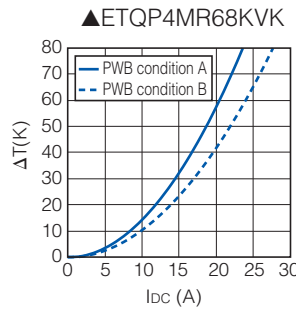
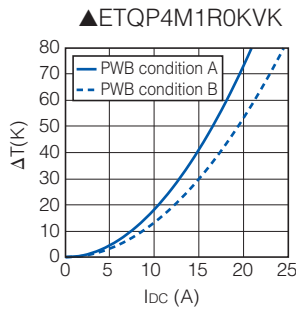
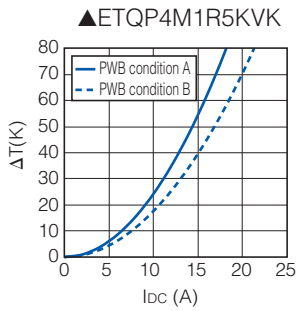
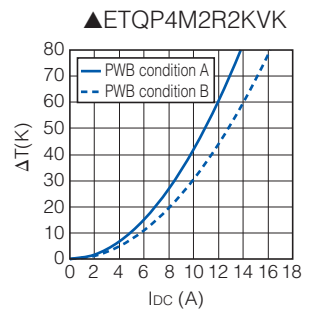
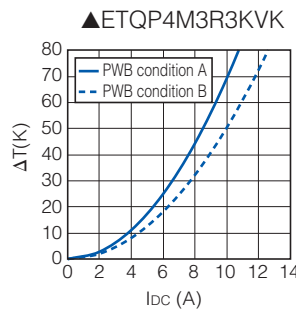
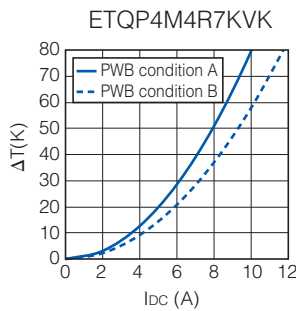
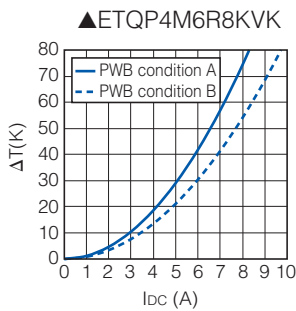
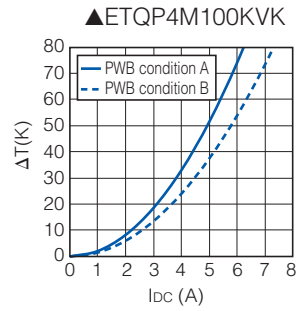
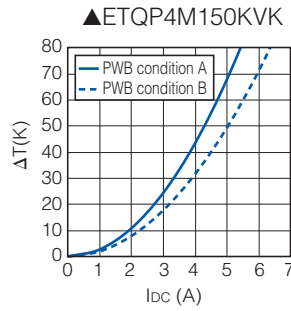
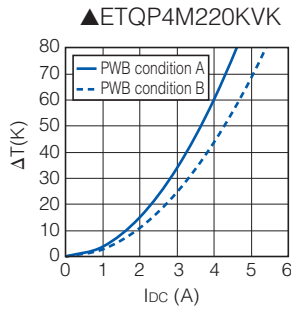
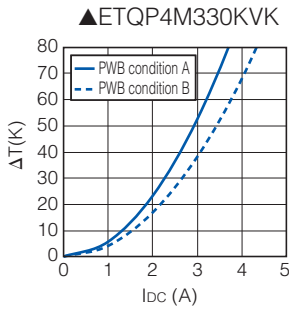

▲ Under development



## 4. Series PCC-M1040M-LP (ETQP4M□□□KVC)

### Standard Parts

Series	Part No.	Inductance *1		DCR (at 20 °C) (mΩ)		Rated Current (Typ. : A)		
		L0 (μH)	Tolerance (%)	Typ. (max.)	Tolerance (%)	ΔT=40K		ΔL=-30%
						(*2)	(*3)	(*4)
PCC-M1040M-LP [10.7×10.0×4.0(mm)]	▲ETQP4M470KVC	47.00	±20	132 (145.2)	±10	2.8	3.4	4.7
	▲ETQP4M330KVC	33.00		84.6 (93.06)		3.4	4.2	5.6
	▲ETQP4M220KVC	22.00		60 (66)		4.1	5.0	7.4
	▲ETQP4M150KVC	15.00		37 (40.7)		5.2	6.3	9.2
	▲ETQP4M100KVC	10.00		25.4 (27.94)		6.3	7.6	10.8
	▲ETQP4M6R8KVC	6.80		18.5 (20.35)		7.4	8.9	12.1
	▲ETQP4M4R7KVC	4.70		11.8 (12.98)		9.2	11.2	13.9
	▲ETQP4M3R3KVC	3.30		9.4 (10.34)		10.3	12.6	17.1
	▲ETQP4M2R2KVC	2.20		6.8 (7.48)		12.1	14.8	21.0
	▲ETQP4M1R5KVC	1.50		4.9 (5.39)		14.3	17.4	25.0
▲ETQP4M1R0KVC	1.00	2.6 (2.86)	19.6	23.9	34.6			

(\*1) Measured at 100k Hz.

(\*2) DC current which causes temperature rise of 40K. Parts are soldered by reflow on four-layer PWB (1.6 mm FR4) and measured at room temperature. See also (\*5)

(\*3) DC current which causes temperature rise of 40K. Parts are soldered by reflow on multilayer PWB with high heat dissipation performance. Note: Heat radiation constant are approx. 27 K/W measured on 10.7×10.0×4.0 mm case size. See also (\*5)

(\*4) Saturation rated current : DC current which causes L(0) drop -30 %.

(\*5) Within a suitable application, the part's temperature depends on circuit design and certain heat dissipation conditions. This should be double checked in a worst case operation mode.

In normal case, the max.standard operating temperature of +155 °C should not be exceeded.

For higher operating temperature conditions, please contact Panasonic representative in your area.

▲ Under development (Start of mass production: the 2nd half of 2017) Please contact us for customized part no.

### Performance Characteristics (Reference)

#### ● Inductance vs DC Current

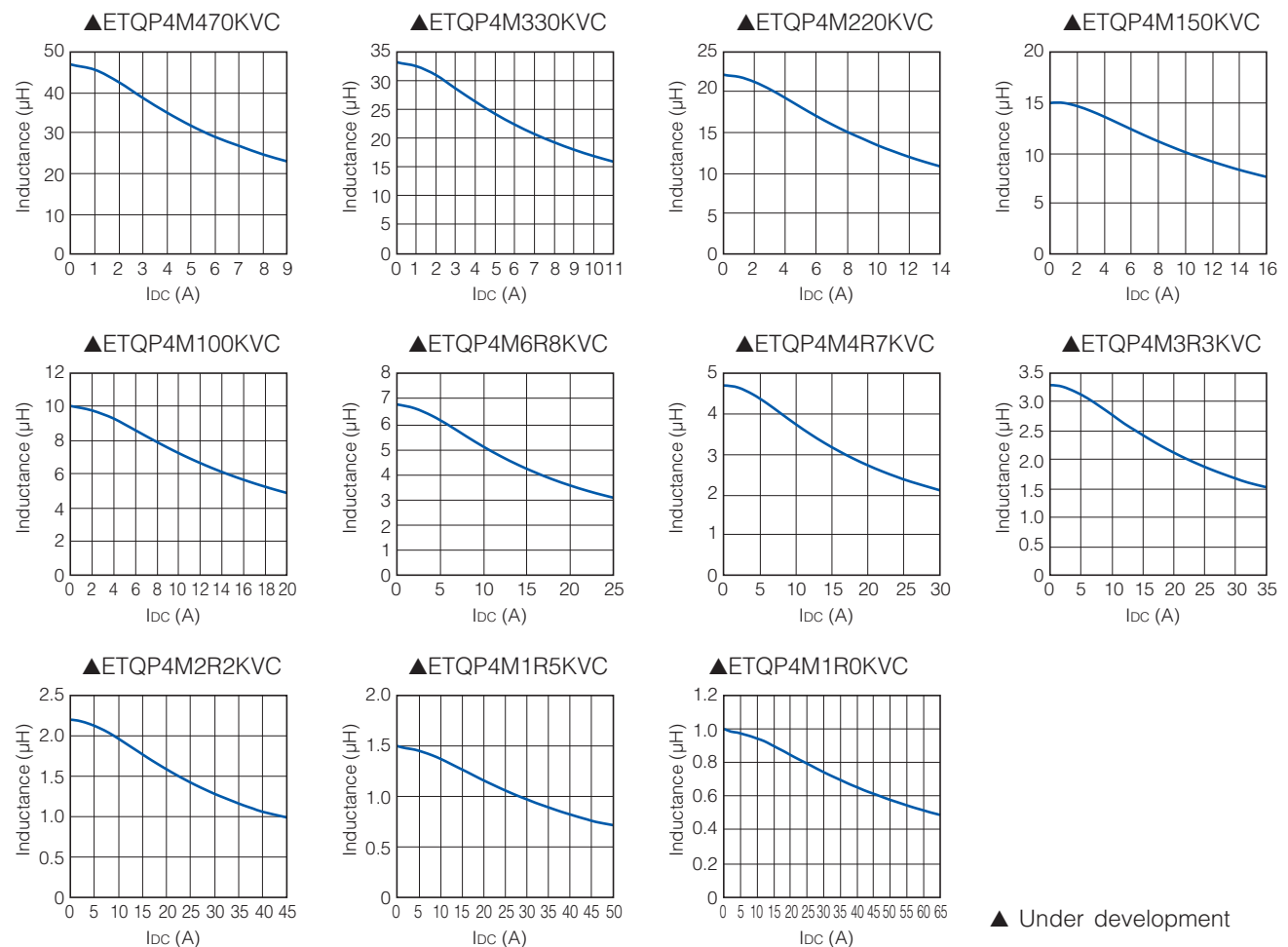

## Performance Characteristics (Reference)

### ● Case Temperature vs DC Current

PWB condition A : Four-layer PWB (1.6 mm FR4), See also (\*2)

PWB condition B : Multilayer PWB with high heat dissipation performance. See also (\*3)

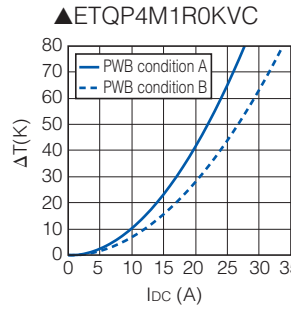
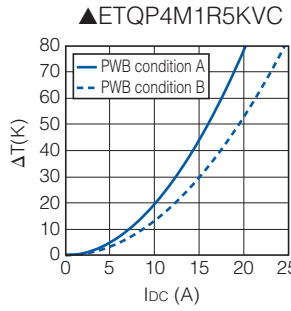
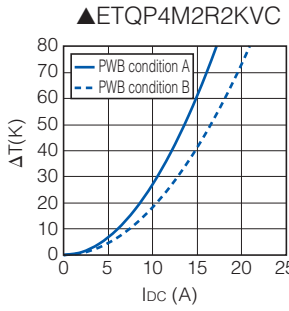
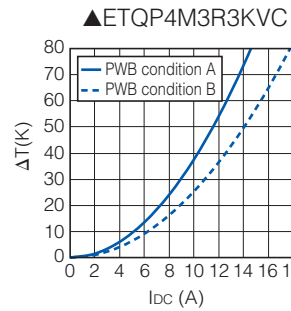
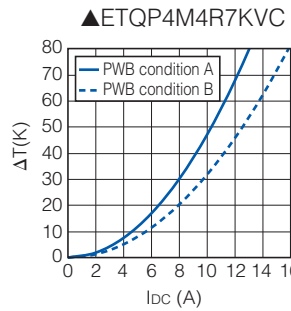
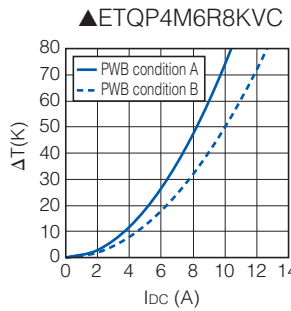
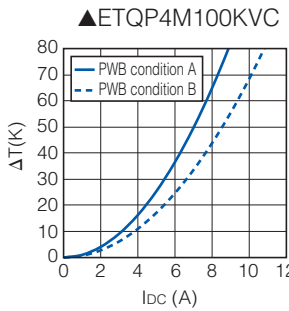
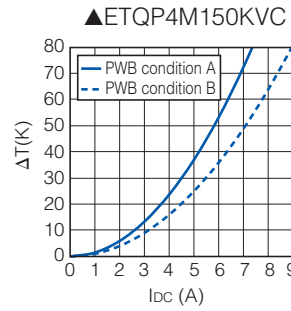
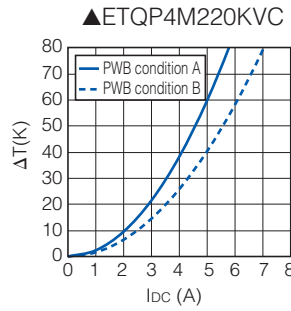
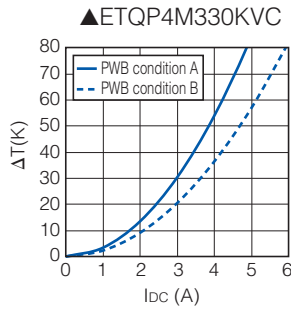
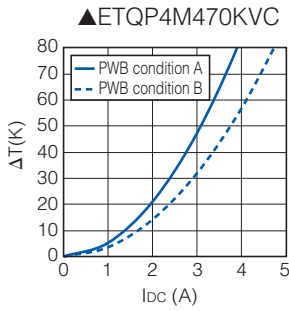

▲ Under development

## Dimensions in mm (not to scale)

Dimensional tolerance unless noted :  $\pm 0.5$

**Series PCC-M0530M-LP**  
(ETQP3M□□□KVP)

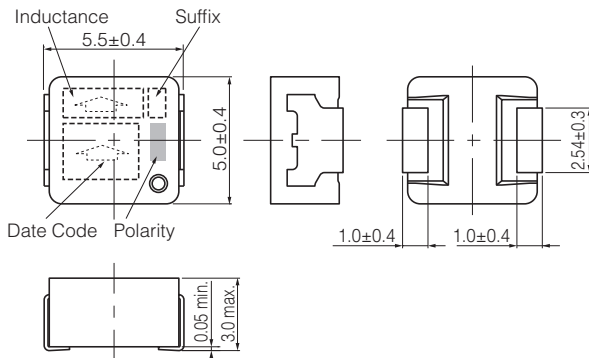

**Series PCC-M0630M-LP**  
(ETQP3M□□□KVN)

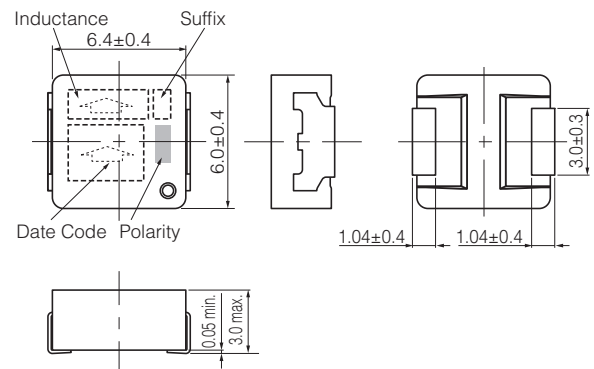

**Series PCC-M0840M-LP**  
(ETQP4M□□□KVK)

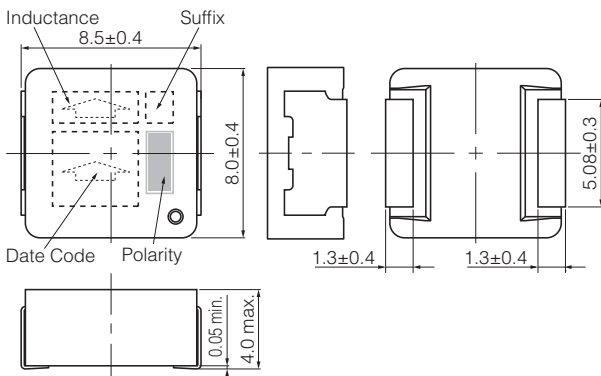

**Series PCC-M1040M-LP**  
(ETQP4M□□□\*KVC)  
\* Exemption "1R0"

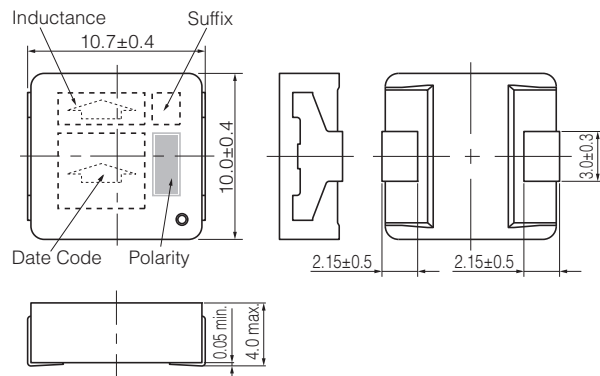

**Series PCC-M1040M-LP**  
(ETQP4M1R0KVC)

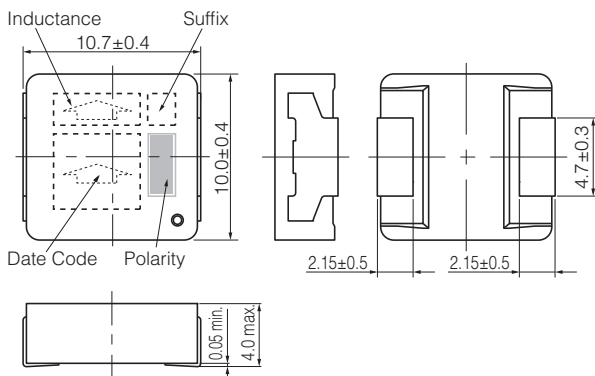

## Recommended Land Pattern in mm (not to scale)

Dimensional tolerance unless noted :  $\pm 0.5$

Series PCC-M0530M-LP  
(ETQP3M□□□KVP)

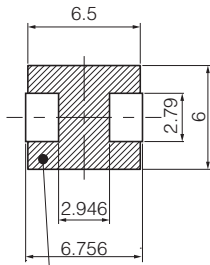

Don't wire on the pattern on shaded portion the PWB.

Series PCC-M0630M-LP  
(ETQP3M□□□KVN)

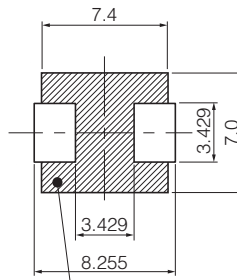

The same as the left.

Series PCC-M0840M-LP  
(ETQP4M□□□KVK)

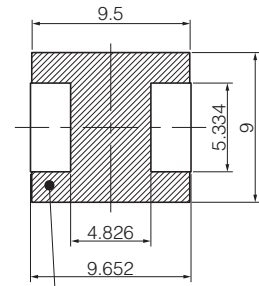

The same as the left.

Series PCC-M1040M-LP  
(ETQP4M□□□\*KVC)  
\* Exemption "1R0"

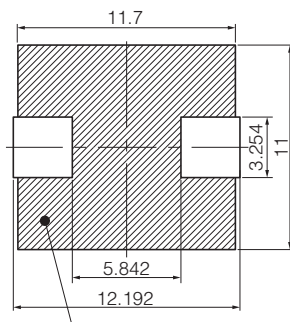

Don't wire on the pattern on shaded portion the PWB.

Series PCC-M1040M-LP  
(ETQP4M1R0KVC)

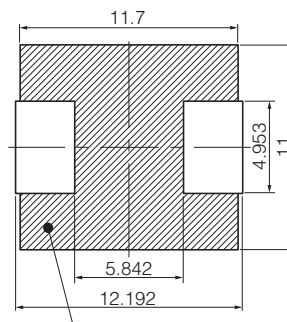

The same as the left.

### ■ As for Soldering Conditions and Safety Precautions (Power Choke Coils for Automotive application),

Please see Data Files

## Packaging Methods (Taping)

- Embossed Carrier Tape Dimensions in mm (not to scale)

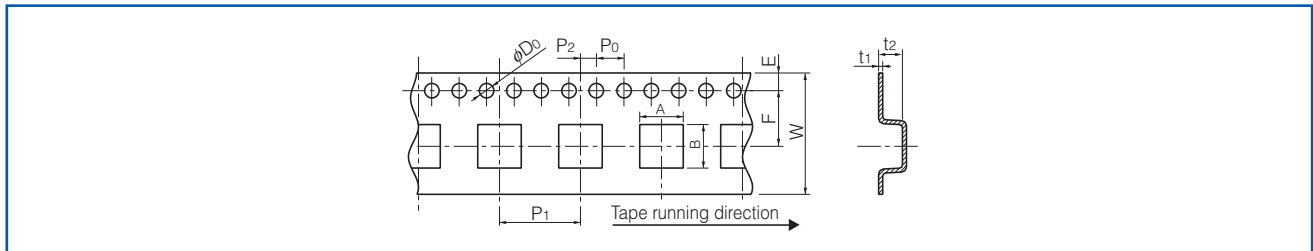

Series	A	B	W	E	F	P <sub>1</sub>	P <sub>2</sub>	P <sub>0</sub>	φD <sub>0</sub>	t <sub>1</sub>	t <sub>2</sub>
PCC-M0530M-LP	5.6	6.1	16	1.75	7.5	8	2	4	1.5	0.3	3.3
PCC-M0630M-LP	6.5	7.1	16	1.75	7.5	8	2	4	1.5	0.3	3.3
PCC-M0840M-LP	8.63	9.1	16	1.75	7.5	12	2	4	1.5	0.4	6.0
PCC-M1040M-LP	10.65	11.75	24	1.75	11.5	16	2	4	1.5	0.5	6.35

- Taping Reel Dimensions in mm (not to scale)

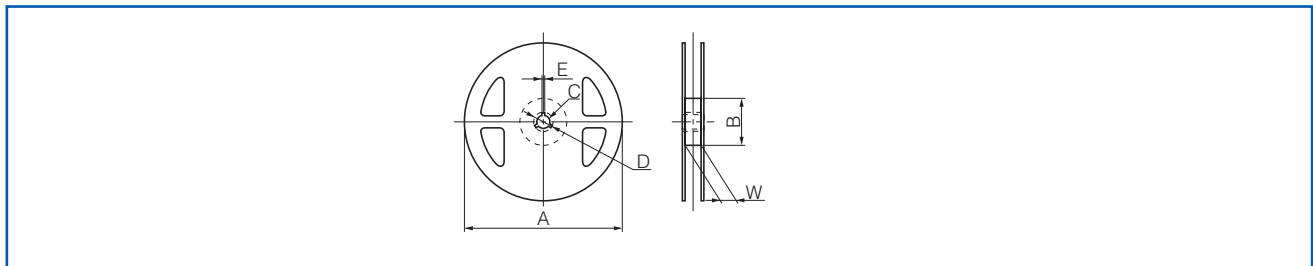

Series	A	B	C	D	E	W
PCC-M0530M-LP PCC-M0630M-LP PCC-M0840M-LP	330	(100)	13	21	2	17.5
PCC-M1040M-LP						25.5

## Component Placement (Taping)

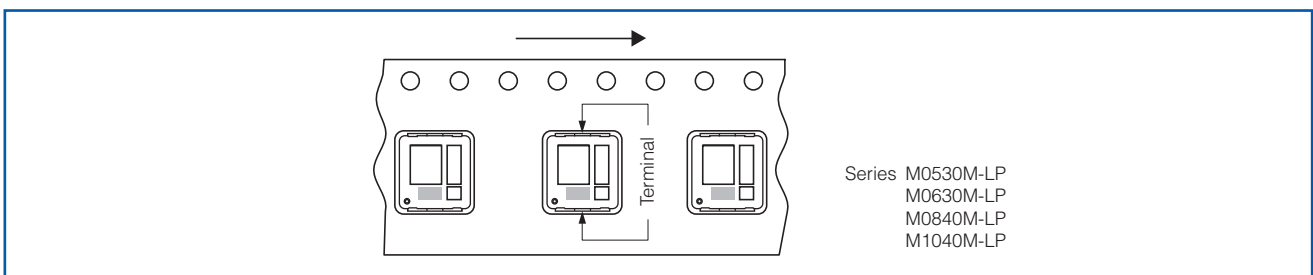

## Standard Packing Quantity/Reel

Series	Part No.	Minimum Quantity / Packing Unit	Quantity per reel
PCC-M0530M-LP	ETQP3M□□□KVP	4,000 pcs. / box (2 reel)	2,000 pcs.
PCC-M0630M-LP	ETQP3M□□□KVN	4,000 pcs. / box (2 reel)	2,000 pcs.
PCC-M0840M-LP	ETQP4M□□□KVK	1,000 pcs. / box (2 reel)	500 pcs.
PCC-M1040M-LP	ETQP4M□□□KVC	1,000 pcs. / box (2 reel)	500 pcs.