



Chipsmall Limited consists of a professional team with an average of over 10 year of expertise in the distribution of electronic components. Based in Hongkong, we have already established firm and mutual-benefit business relationships with customers from,Europe,America and south Asia,supplying obsolete and hard-to-find components to meet their specific needs.

With the principle of "Quality Parts,Customers Priority,Honest Operation,and Considerate Service",our business mainly focus on the distribution of electronic components. Line cards we deal with include Microchip,ALPS,ROHM,Xilinx,Pulse,ON,Everlight and Freescale. Main products comprise IC,Modules,Potentiometer,IC Socket,Relay,Connector.Our parts cover such applications as commercial,industrial, and automotives areas.

We are looking forward to setting up business relationship with you and hope to provide you with the best service and solution. Let us make a better world for our industry!



Contact us

Tel: +86-755-8981 8866 Fax: +86-755-8427 6832

Email & Skype: info@chipsmall.com Web: www.chipsmall.com

Address: A1208, Overseas Decoration Building, #122 Zhenhua RD., Futian, Shenzhen, China



Evaluation Board for the **AD4000** Series 16-/18-Bit Precision SAR ADCs

FEATURES

- Fully featured evaluation board for 10-lead precision ADCs
- Versatile analog signal conditioning circuitry
- On-board reference, reference buffers, and ADC drivers
- PC software for control and data analysis of time and frequency domain
- System demonstration platform-compatible ([EVAL-SDP-CH1Z](#))

EVALUATION BOARD KIT CONTENTS

- [AD4000/AD4001/AD4003](#) evaluation board (see Table 6)
- 12 V wall adapter power supply

EQUIPMENT NEEDED

- [SDP-H1](#) board ([EVAL-SDP-CH1Z](#))
- Precision signal source
- Cable (SMA input to evaluation board)
- Standard USB A to mini-B USB cable
- Band-pass filter suitable for 16-bit and 18-bit testing (value based on signal frequency)

GENERAL DESCRIPTION

The [AD4000/AD4001/AD4003](#) family evaluation board covers the ease of use, 16-/18-bit, precision successive approximation register (SAR) analog-to-digital converters (ADCs). The [AD4000/AD4001/AD4003](#) are low power, 16-bit/18-bit, precision SAR ADCs that offer very high performance with throughputs up to 2 MSPS. The evaluation board is designed to demonstrate the performance of the [AD4000/AD4001/AD4003](#) family of ADCs and to provide an easy to understand interface for a variety of system applications. A full description of these products is available in their respective data sheets, which must be consulted when using this evaluation board.

The [EVAL-AD4000FMZ/EVAL-AD4001FMZ/EVAL-AD4003FMCZ](#) evaluation boards (see Figure 1) are ideal for use with the Analog Devices, Inc., high speed system demonstration platform ([EVAL-SDP-CH1Z](#)). These evaluation boards interface to the [SDP-H1](#) board via a 120-pin connector. SMA connectors, JP2 and JP3, are provided for the low noise analog signal source.

On-board components include a high precision buffered band gap 5.0 V reference (the [ADR4550](#)), a reference buffer (the [ADA4807-1](#)), a common-mode buffer (the [ADA4807-1](#)), a signal conditioning circuit with two op amps (the [ADA4807-1](#)), and a power supply to derive the necessary voltage levels to supply all voltage needs.

EVALUATION BOARD PHOTOGRAPH

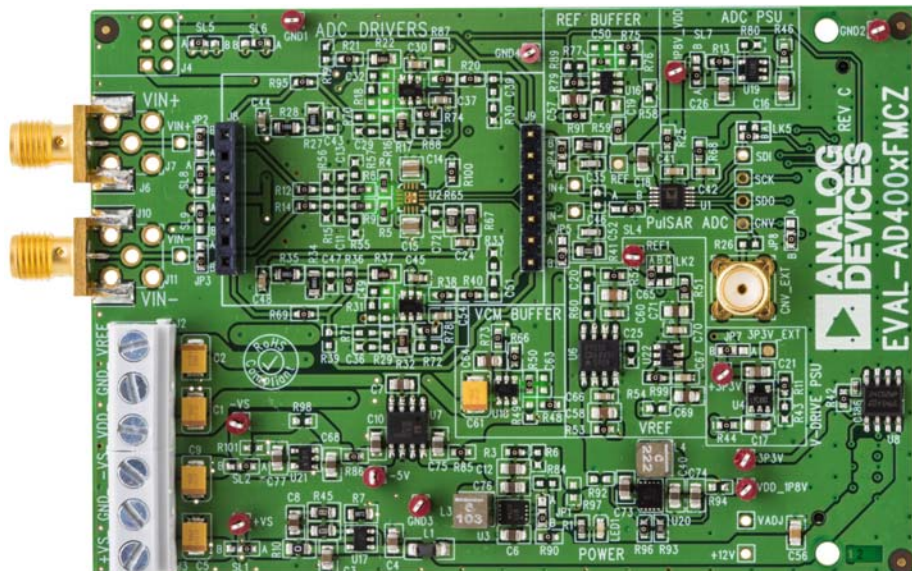

Figure 1.

TABLE OF CONTENTS

Features	1	Board Operation/Connection Sequence	7
Evaluation Board Kit Contents	1	Running the Software with the Hardware Connected	7
Equipment Needed	1	Software Operation	8
General Description	1	Description of the User Panel	9
Evaluation Board Photograph	1	Waveform Capture	11
Revision History	2	AC Testing—Histogram	12
Evaluation Board Hardware	3	DC Testing—Histogram	12
Setting Up the Evaluation Board	3	AC Testing—FFT Capture	13
Power Supplies	3	Summary Tab	14
Reference, Reference Buffer, and Common-Mode Buffer	3	Troubleshooting	15
SDP-H1 Controller Board	3	Software	15
Solder Links	4	Hardware	15
Analog Inputs	4	Evaluation Board Schematics	16
Evaluation Board Software	5	Products on This Evaluation Board	22
Installing the Software	5	AD4000/AD4001/AD4003 Bill of Materials	22
Installation Steps	5	Related Links	23

REVISION HISTORY

1/2017—Rev. A to Rev. B

Added AD4001	Universal
Changes to User Guide Title	Throughout
Changes to User Guide Subject Line	1
Changes to Figure 2	3
Changes to Table 3	4
Moved Troubleshooting Section	15
Changes to Table 5	22
Changes to Table 6	23

11/2016—Rev. 0 to Rev. A

Added Figure 1, Renumbered Sequentially	1
Changes to General Description Section	1
Changes to Setting Up the Evaluation Board	3

12/2016—Revision 0: Initial Version

EVALUATION BOARD HARDWARE

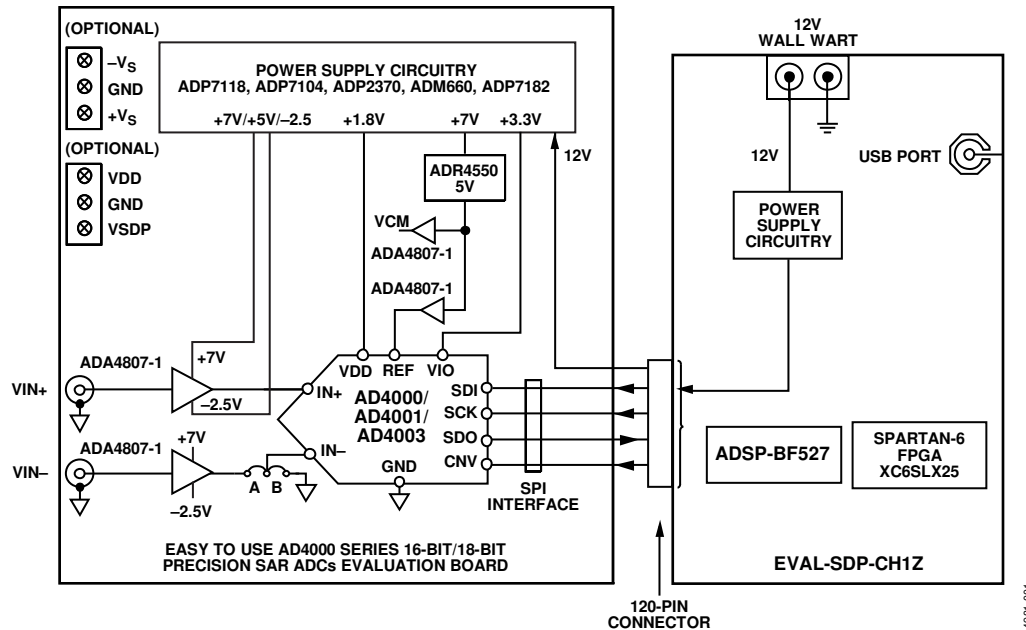

Figure 2. Simplified Evaluation Board Block Diagram

SETTING UP THE EVALUATION BOARD

Figure 2 shows the simplified evaluation board block diagram. Figure 25 shows the evaluation board schematic. The board consists of the ADC, U1, with a reference, U6 (ADR4550), and ADC drivers, U12 and U14, the ADA4807-1 for the AD4003/AD4001 and the ADA4805-1 for the AD4000 (see Table 5). The user also has an option to use a low power, fully differential ADC driver, U2, by populating the ADA4940-1. The evaluation board is a flexible design that enables the user to select components in addition to operating from an adjustable bench top power supply.

POWER SUPPLIES

The system demonstration platform (SDP-H1) board supplies 12 V to power necessary rails for the AD4000/AD4001/AD4003 evaluation board.

Table 1. Power Supplies Provided on the Board

Power Supply (V)	Function	Components Used
5, 7 (default) ¹	Positive rail	ADP7118
-5, -2.5 (default) ¹	Negative rail	ADP2370, ADM660, ADP7182
1.8	ADC power	ADP7118, ADP5300
3.3	V _{DRIVE} (digital power)	ADP7118

¹ See Table 2.

The 7 V amplifier positive rail (+V_S) is generated from U17, (the ADP7118). The -2.5 V negative amplifier rail (-V_S) is generated by a combination of U3 (the ADP2370), U7 (the ADM660), and U21 (the ADP7182).

Each supply is decoupled where it enters the board and again at each device. A single ground plane is used on this board to minimize the effect of high frequency noise interference.

In addition to this, there is also the ability to power the board from a bench top power supply. The screw terminals, J2 and J3, are provided for this function. When bench power is used, the on-board power supplies are no longer required. Solder links also must be changed: SL1 = SL2 = SL5 = SL6 = SL7 = SL8 = SL9 = B.

REFERENCE, REFERENCE BUFFER, AND COMMON-MODE BUFFER

An external 5 V reference (U6, ADR4550) is used by default to supply the ADCs directly. However, the user can also use one of the 2.5 V, 3.3 V, and 4.096 V references by changing the reference (U6) on the board. There is also an option to use a lower power reference (U22, ADR3450). Note that the ADR3450 cannot accept input voltage beyond 5.5 V. The ADA4807-1 is used as a reference buffer (U16) and common-mode buffer (U18) by default. However, it can also be replaced by the AD8031 if needed without compromising the performance.

SDP-H1 CONTROLLER BOARD

The evaluation board uses the SPI interface and it is connected to the high speed controller board for the system demonstration platform (SDP-H1) controller board. The SDP-H1 board requires power from a 12 V wall adapter. The SDP-H1 has a Xilinx® Spartan 6 and an ADSP-BF527 processor with connectivity to the PC through a USB 2.0 high speed port. Controller boards allow the configuration and capture of data on daughter boards from the PC via USB.

The [SDP-H1](#) has a FMC low pin count (LPC) connector with full differential LVDS and singled ended LVCMOS support. It also has the 120-pin connector, found on the SDP-B, which exposes the Blackfin processors peripherals. This connector provides a configurable serial, parallel I²C and SPI, and GPIO communications lines to the attached daughter board.

SOLDER LINKS

The three-solder link options on the board are configured depending on which generic of the ADC is on the specific evaluation board as described in Table 3.

Table 2. Table of Jumper Detail with Factory Default Setting

Link	Default	Function	Comment
SL1	A	+V _S	Change to B if using bench supplies
SL2	A	-V _S	Change to B if using bench supplies
SL5	A	+V _S	Change to B if using bench supplies
SL6	A	-V _S	Change to B if using bench supplies
SL7	A	VDD for ADC	Change to B if using bench supplies
SL8	A	-V _S	Change to B if using bench supplies
SL9	A	+V _S	Change to B if using bench supplies
LK2	A	VREF	Change to B if using the ADR3450
LK5	B	SDI	Change to A if using V_DRIVE
JP1	B	FSEL (U3)	Change to A if using Ground
JP2	B	ADC drivers	Change to A if using FDA ADA4940-1
JP3	B	ADC drivers	Change to A if using FDA ADA4940-1
JP4	B	ADC drivers	Change to A if using FDA ADA4940-1
JP5	B	ADC drivers	Change to A if using FDA ADA4940-1
JP7	B	V_DRIVE	Change to A if using external 3.3 V for V_DRIVE
JP8	B	STOP (U20)	Change to A if using CNV_FMC from SDP-H1 connector

Table 3. Table of Jumpers Specific to 10-Lead Precision ADCs

Link	Default	Configuration	Generic
SL4	A	Differential input	AD4001 , AD4003
SL4	B	Single-ended or pseudo differential	AD4000

ANALOG INPUTS

The analog inputs to the evaluation board are SMA connectors, J6 and J10. These inputs are buffered with dedicated amplifier circuitry (U12 and U14), as shown in Figure 25. The circuit allows different configurations, input range scaling, filtering, addition of a dc component, and use of different op amp and supplies. The analog input amplifiers are set as unity-gain buffers at the factory.

The default configuration sets both U12 and U14 at midscale, generated from a buffered reference voltage divider (VCM).

The evaluation board is factory configured for providing either a single-ended path or a fully differential path.

For dynamic performance, a fast Fourier transform (FFT) test can be performed by applying a very low distortion ac source.

For low frequency testing, the audio precision source (such as the SYS-2700 series) can be used directly because the outputs on these are isolated. Set the outputs for balanced and floating ground. Different precision sources can be used with additional filtering.

Because the evaluation board uses the amplifiers in unity-gain, the noninverting input has a common-mode input with a 590 Ω resistor divider, and it must be taken into account when directly connecting a source.

EVALUATION BOARD SOFTWARE

INSTALLING THE SOFTWARE

The evaluation board software can be downloaded from the relevant product page on the Analog Devices website.

Install the software before connecting the **SDP-H1** board to the USB port of the PC. This ensures that the **SDP-H1** board is recognized when it connects to the PC.

1. Start the Windows® operating system and download the software from the relevant product page on the Analog Devices website.
2. Unzip the downloaded file. Run the **setup.exe** file.
3. After installation is completed, power up the evaluation board as described in the Power Supplies section.
4. Plug the evaluation board into the **SDP-H1** board and the **SDP-H1** board into the PC using a USB cable.
5. When the software detects the evaluation board, proceed through any dialog boxes that appear to finalize the installation.

The default location for the software is the following:

C:\Program Files\Analog Devices\AD40XX Evaluation Software\EVAL-AD40XX.

This location contains the executable software and example files.

INSTALLATION STEPS

Proceed through the installation, allowing the software and drivers to be placed in the appropriate locations. Connect the **SDP-H1** board to the PC only after the software and drivers are installed.

There are two parts to the software installation. First, install the software related to the evaluation board, as follows:

1. Launch the evaluation board software installation by clicking the **setup.exe** file. The software installation window opens as shown in Figure 3.

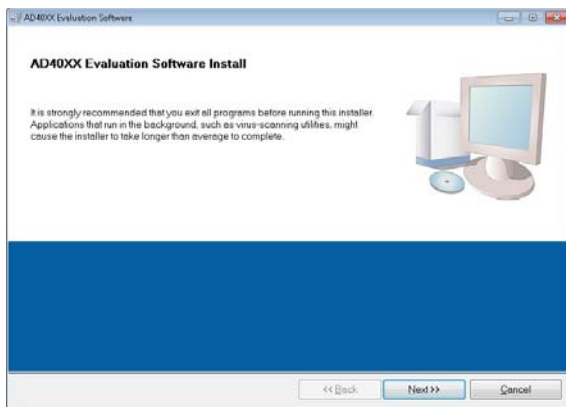

Figure 3. Evaluation Software Install

2. Choose the folder location for installation and click **Next**. The default folder is shown in Figure 4.

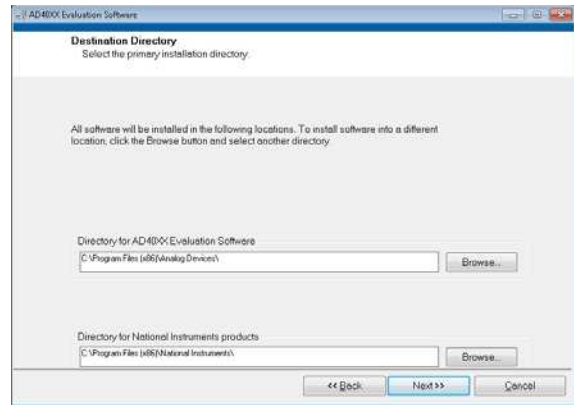

Figure 4. Destination Directory

3. Accept the National Instruments software license agreement and click **Next**.

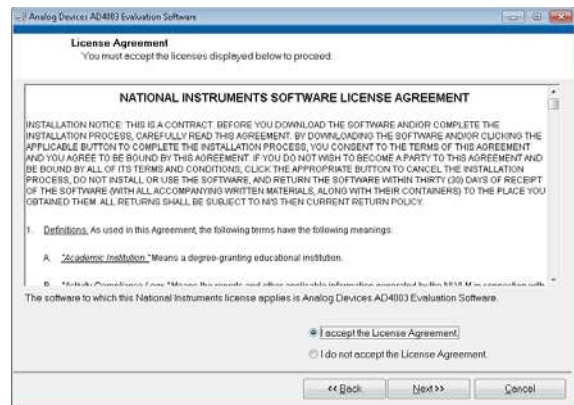

Figure 5. License Agreement

4. Click **Next** again to install the software.

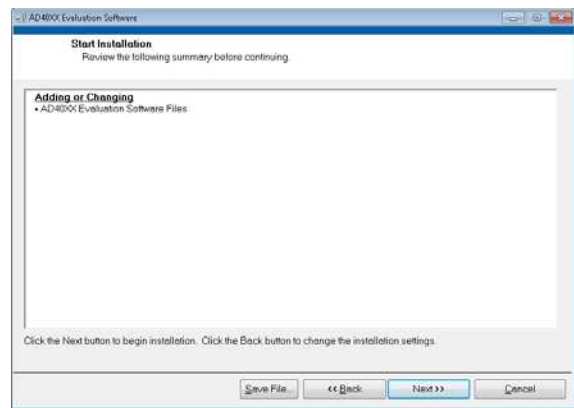

Figure 6. Start Installation

- A pop up window opens and displays a bar showing the installation progress, as shown in Figure 7.

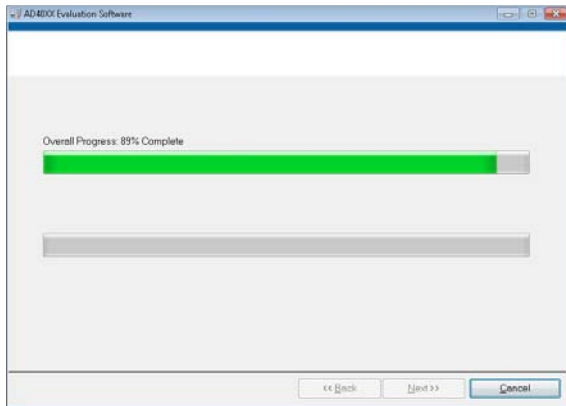

Figure 7. Overall Progress

- Click **Next** to complete the installation and to launch the **SDP-H1** driver installation as shown in Figure 9.

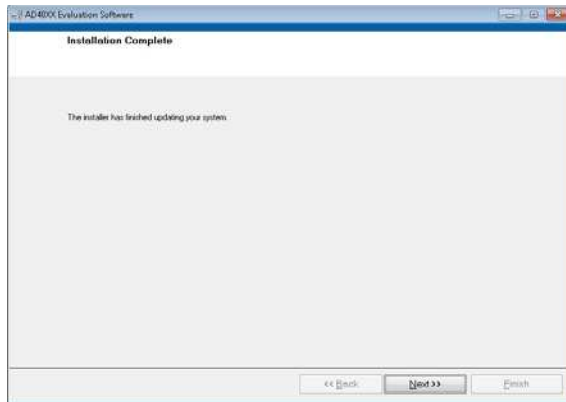

Figure 8. Installation Complete

The second part of the software installation is the drivers related to the **SDP-H1** board. These drivers must be installed for the evaluation board to function correctly.

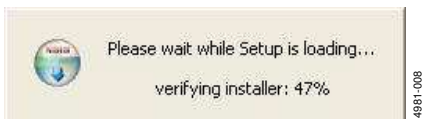

Figure 9. Beginning of **SDP-H1** Driver Installation

- The ADI SDP driver setup wizard opens. Click **Next** to install the ADI **SDP-H1** driver.

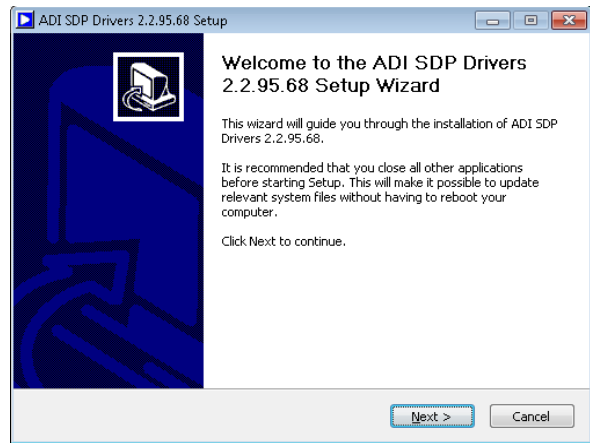

Figure 10. ADI SDP Drivers Setup Wizard

- Choose the installation location and click **Install**; the default folder is shown in Figure 11.

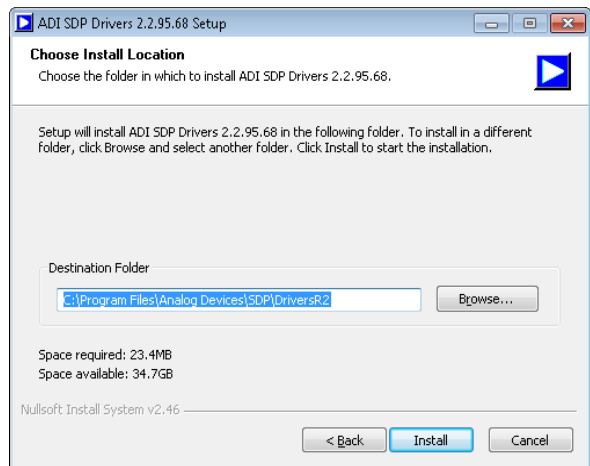

Figure 11. Choose Install Location

- The installation begins, and a progress bar is displayed.

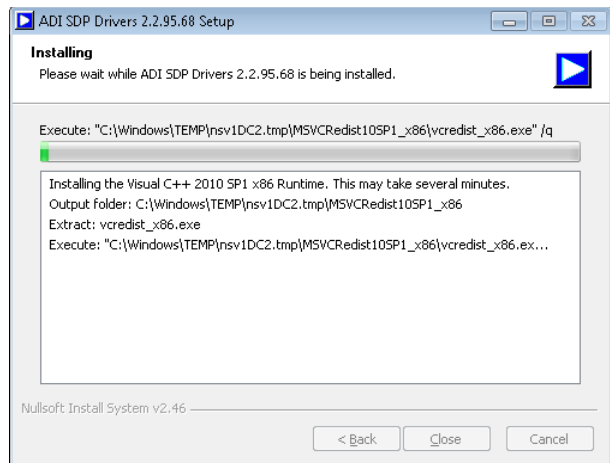

Figure 12. Installing

10. Click **Close** to complete the installation.

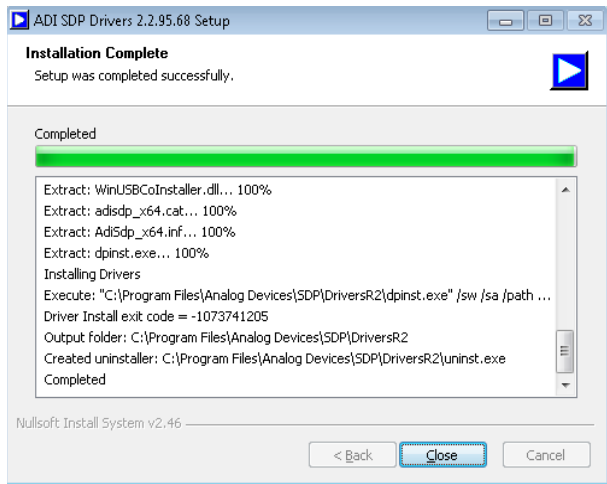

Figure 13. Installation Complete

When you first plug in the **SDP-H1** board via the USB cable provided, allow the new Found Hardware wizard to run. You can check that the drivers and the board are connected correctly by looking at the Device Manager of the PC. **Analog Devices System Development Platform (32MB)** appears under **ADI Development Tools**.

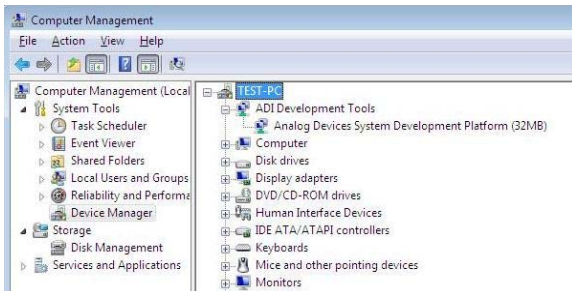

Figure 14. Device Manager

BOARD OPERATION/CONNECTION SEQUENCE

The following is the board operation/connection sequence:

1. Connect the **SDP-H1** controller board to the evaluation board with the J5 connector (screw into place as required). The software is configured to find the evaluation board on either connector of the **SDP-H1** board.
2. Power the board with the appropriate supply as described in the Power Supplies section.
3. Connect to the PC with the USB cable.
4. Launch the software. Click **Start > All Programs > Analog Devices\ AD40XX Evaluation Software\EVAL-AD40XX**.
5. Apply the signal source and capture the data.

RUNNING THE SOFTWARE WITH THE HARDWARE CONNECTED

To run the program, take the following steps:

1. Click **Start > All Programs > Analog Devices > AD40XX Evaluation Software > EVAL-AD40XX**. To uninstall the program, click **Start > Control Panel > Programs and Features > Analog Devices AD40XX Evaluation Software**.
2. The software automatically seeks to find the hardware connected; therefore, when no hardware is connected, it displays a connectivity error (see Figure 15) when the software is launched. Connect the evaluation board to the **SDP-H1** and connect the **SDP-H1** to the USB port of the PC, wait for a few seconds, click **Rescan**, and then follow the instructions.

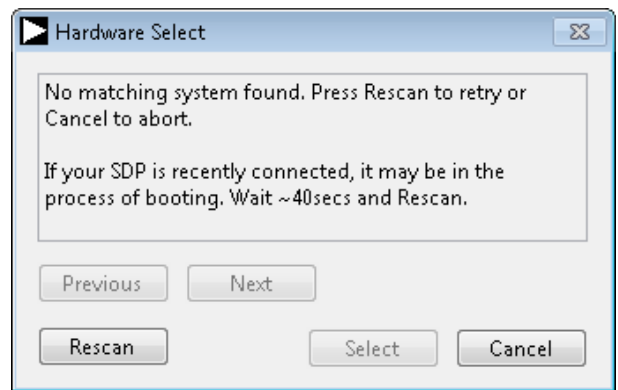

Figure 15. SDP-H1 Board Not Connected to the USB Port Error

3. If **Cancel** is clicked, a message appears as shown in Figure 16.



Figure 16. SDP-H1 Board Not Connected to the USB Port Error

4. The software then connects to the board and displays the message shown in Figure 17.

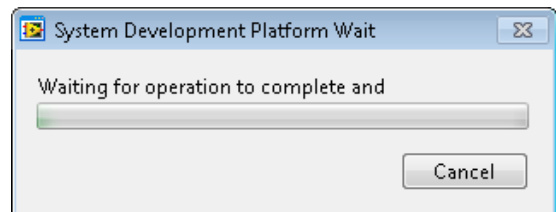

Figure 17. Software Connects to SDP-H1 Board

5. When the board is correctly detected, the software panel opens.

SOFTWARE OPERATION

When the software launches, the panel opens and the software looks for the hardware connected to the PC. The software detects the generic attached to the PC and the product panel then launches as shown in Figure 18.

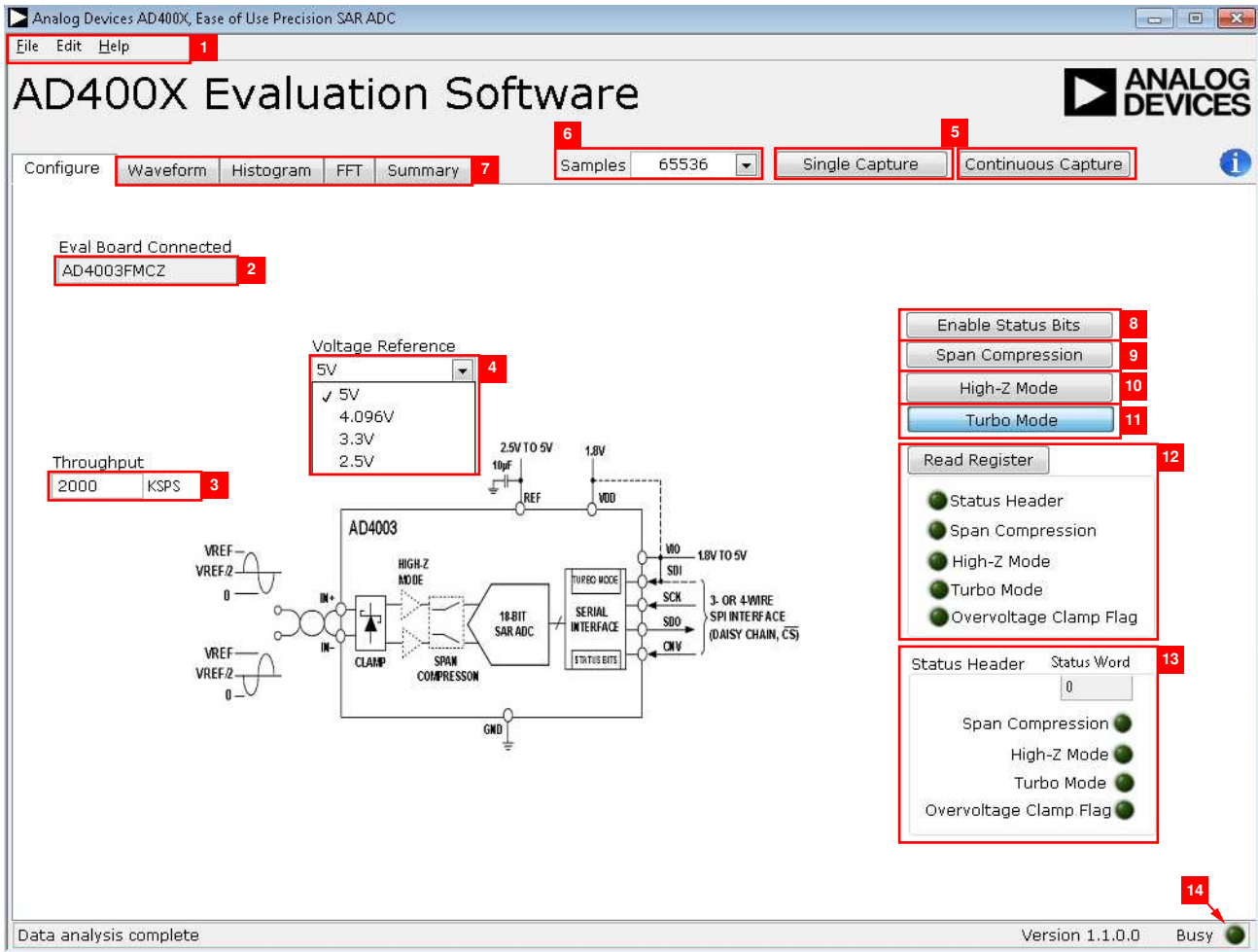

Figure 18. Setup Screen

DESCRIPTION OF THE USER PANEL

The following is the description of the user panel.

The **File** menu (Label 1 in Figure 18) has the choice of the following options:

- **Save Captured Data** allows the user to save the current captured data for later analysis, and the file format is .csv. The user is prompted to choose or enter the path of the file in the **Save As** pop-up (see Figure 19); save to an appropriate folder location.
- **Load Captured Data**; the **Load File** pop-up opens where the user is prompted to load previously captured data in .csv format for analysis.
- **Take Screenshot** allows the user to save the current screen capture as .jpg.
- **Print Screenshot** allows the user to save the current screen capture as .pdf.
- **Exit** stops running the application software.

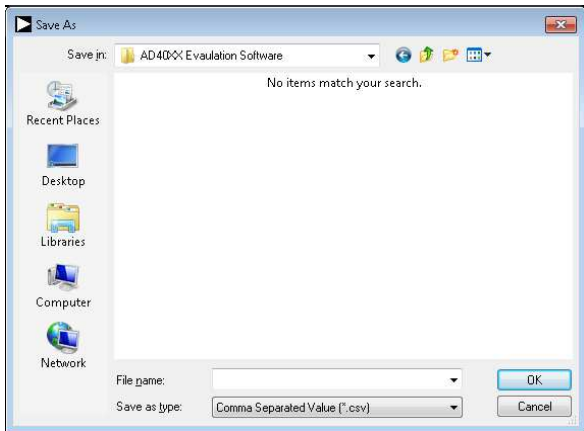

Figure 19. **Save As** Dialog Box

The **Edit** menu (Label 1 in Figure 18) provides the option (**Reinitialize to Default Values**) to reset the software to its initial state.

The **Help** menu (Label 1 in Figure 18) offers information about the

- **Analog Devices Website**
- **User Guide**
- **Context Help**
- **About**

When hardware is connected to the USB port, the software automatically detects which generic is connected and displays it (Label 2 in Figure 18).

The **Throughput** box is Label 3 in Figure 18. The default throughput (sampling frequency) is 1.75 MSPS. The user can adjust the throughput to minimum of 10 kSPS. If the user enters a value larger than the ability of the existing device, the software reverts to the maximum throughput.

The **Voltage Reference** drop-down menu is Label 4 in Figure 18. By default, this reference is 5 V (ADR4550 on-board reference). The minimum/maximum voltage calculations are based on this

reference voltage. If the user changes the reference voltage, this input must be changed accordingly.

Click **Single Capture** to perform a single capture and click **Continuous Capture** to perform a continuous stream capture from the ADC. (Both are noted with Label 5 in Figure 18.)

Select **Samples** (Label 6 in Figure 18) to analyze data using the particular number of samples. The maximum number of samples the software can support is 524,288.

Four capture tabs (Label 7 in Figure 18) display the data in different formats, as follows:

- **Waveform**
- **Histogram**
- **FFT**
- **Summary**

Click **Enable Status Bits** (Label 8 in Figure 18) to enable the content of status header. Status bits can be clocked out at the end of the conversion data using six extra clocks when it is enabled.

Click **Span Compression** (Label9 in Figure 18) to enable ADC span compression feature. In single-supply applications, the use of span compression increases the headroom and footroom available to the ADC driver by reducing the input range 10% from the top and bottom of the range while still accessing all available ADC codes.

Click **High-Z Mode** (Label 10 in Figure 18) to enable the internal high-Z mode. Enabling this mode allows the low input current for the ADC and improves THD performance using low power/bandwidth precision ADC drivers for slow/dc type signals.

Click **Turbo Mode** (Label 11 in Figure 18) to enable it and run the ADC at full throughput of 2 MSPS.

Click **Register Read (Read Register** (Label 12 in Figure 18) to see if any of ease of use features are enabled, including span compression, high-Z mode, turbo mode, an overvoltage condition (which is a sticky bit) and the status bits.



Clicking **Enable Status Bits** enables the six status bits and content of the six bits is updated and displayed in the **Status Header** section (Label 13 in Figure 18), after clicking single or continuous capture. Note that the overvoltage clamp flag status bit updates on a per conversion basis.

When the **Busy** indicator (Label 14 in Figure 18) is lit, the user must wait until the software completes the data analysis.

To exit the software, select **File > Exit**.

Within any of the chart panels, the tools shown in Table 4 allow user control of the different chart displays.

Table 4. Graphical User Interface (GUI) Tools

Symbol	Description
	This tool controls the cursor, if present.
	This tool zooms in and out.
	This tool is used for panning.

The evaluation software allows the user to export the raw data or image. Right clicking any of the four capture tabs (**Waveform**, **Histogram**, **FFT**, and **Summary**) open the window as shown in Figure 20, and the user can either export raw data in Excel format or save image in .bmp, .eps, or .emf format.

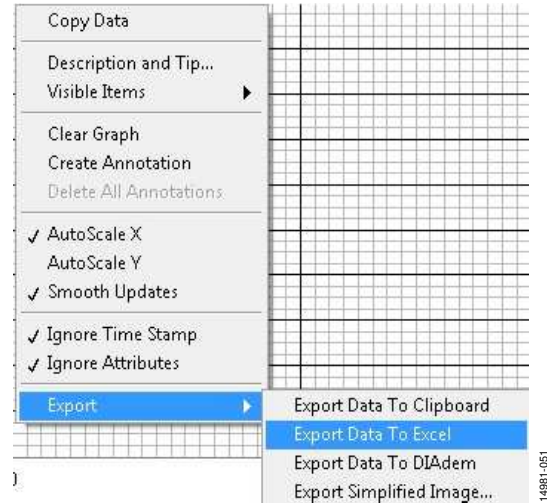

Figure 20. Export Raw Data or Image

WAVEFORM CAPTURE

Figure 21 illustrates the waveform capture. The input signal is a 1 kHz sine wave. The waveform analysis reports the amplitudes recorded from the captured signal in addition to the frequency of the signal tone.

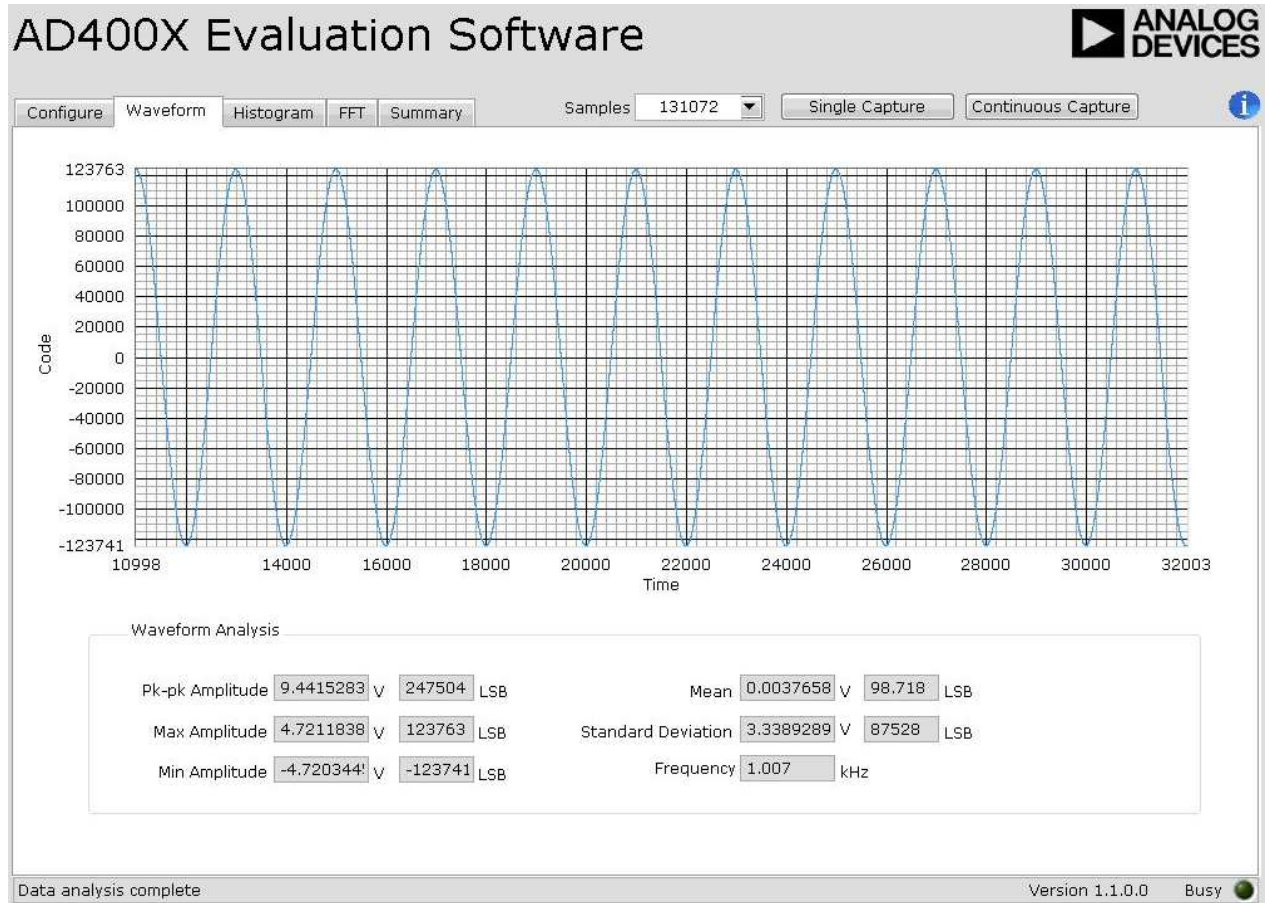

Figure 21. **Waveform Tab**

AC TESTING—HISTOGRAM

The ac testing histogram tests the ADC for the code distribution for the ac input, computes the mean and minimum/maximum amplitude and LSB size of the converter. Raw data is captured and passed to the PC for statistical computations. To perform a histogram test, click the **Histogram** tab and click **Sample or Continuous** stream. Note that an ac histogram needs a quality signal source applied to the J6 and J10 input connectors. Figure 22 shows the histogram for a 1 kHz sine wave applied to the ADC input and illustrates the different measured values for the data captured.

DC TESTING—HISTOGRAM

More commonly, the histogram is used for dc testing where the user tests the ADC for the code distribution for dc input, computes the mean and standard deviation, or transition noise, of the converter, and displays the results. Raw data is captured and passed to the PC for statistical computations. To perform a histogram test, click the **Histogram** tab and click **Start Stream**. Note that a histogram test can be performed without an external source using a $V_{REF}/2$ (590 Ω resistor divider) at the ADC input. To test other dc values, apply a source to the J6 and J10 input connectors. It may be required to filter the signal to make the dc source noise compatible with that of the ADC.

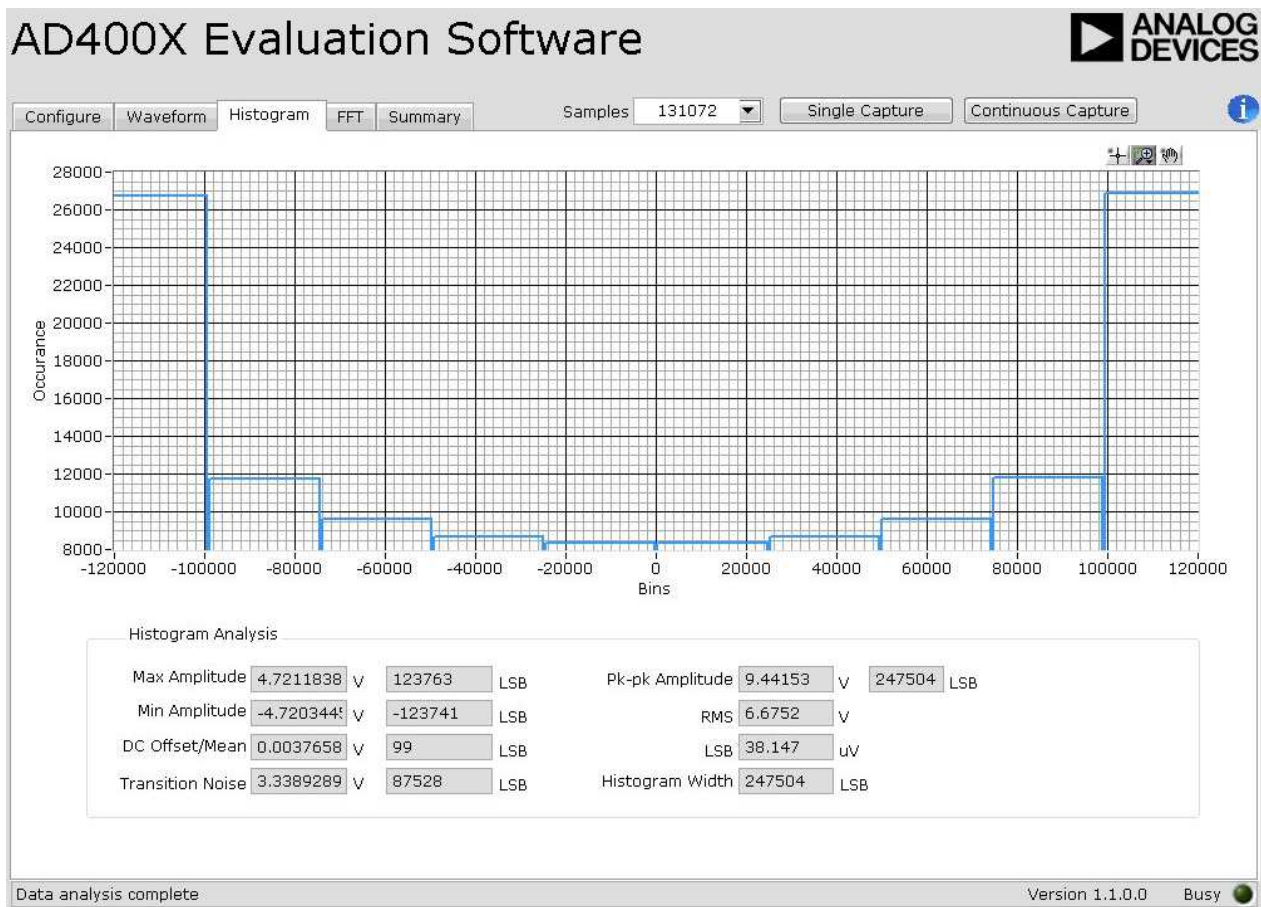

Figure 22. **Histogram** Tab, Histogram Captured for Sine Wave

AC TESTING—FFT CAPTURE

The traditional ac characteristics of the converter can be displayed on the FFT tab. As in the histogram test, raw data is captured and passed to the PC where the FFT is performed displaying signal-to-noise ratio (SNR), signal-to-noise-and-distortion ratio (SINAD), total harmonic distortion (THD), and spurious-free dynamic range (SFDR). The data can also be displayed in the time domain. To perform an ac test, apply a sinusoidal signal to the evaluation board at the SMA inputs, J6 and J10. Low distortion, better than 100 dB, is required to allow true evaluation of the device. One possibility is to filter the input signal from the ac source. A band-pass filter can be used, and its center frequency must match the test frequency of interest.

Furthermore, if using a low frequency band-pass filter when the full-scale input range is more than a few volts peak-to-peak, use the on-board amplifiers to amplify the signal, thus preventing the filter from distorting the input signal.

Figure 23 displays the histogram of the captured data that includes the following:

- The spectrum information
- The fundamental frequency and amplitude in addition to the second to fifth harmonics
- The performance data (SNR, dynamic range, THD, SINAD, and noise performance)

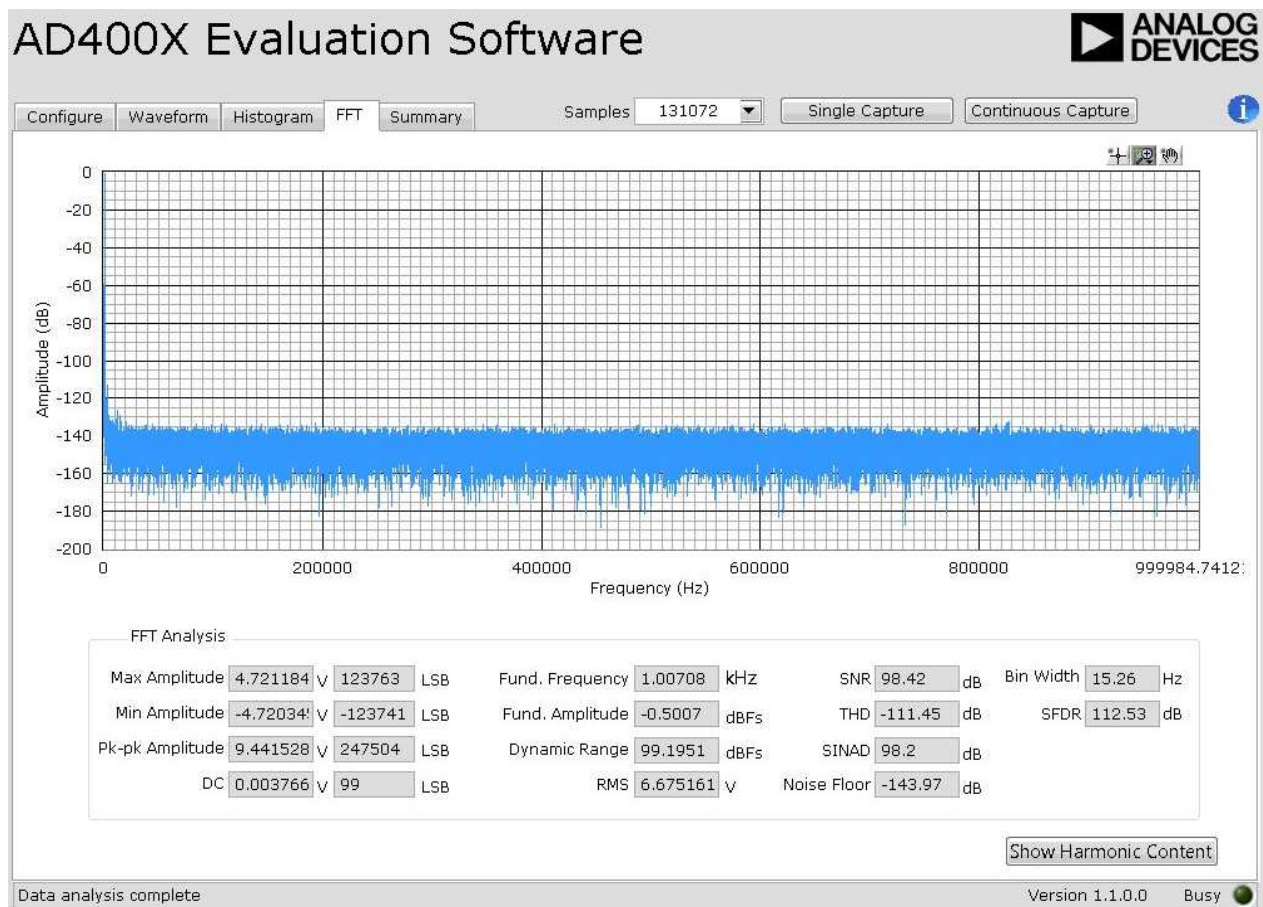

Figure 23. FFT Tab (AD4003 Running in Turbo Mode)

SUMMARY TAB

The **Summary** tab captures all the display information and provides them in one panel with a synopsis of the information including key performance parameters, such as SNR and THD.

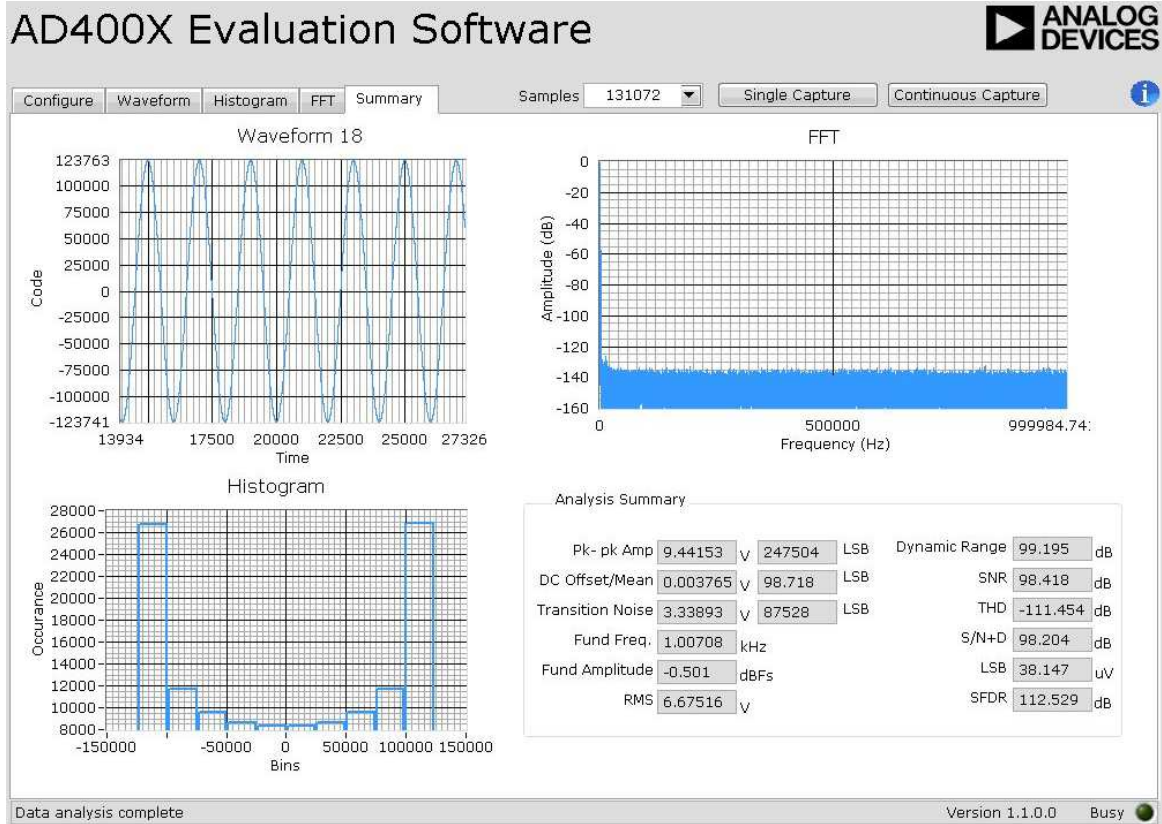

Figure 24. Summary Tab, Shows All Captured Windows

TROUBLESHOOTING

SOFTWARE

To troubleshoot the software, take the following steps:

1. Always install the software before connecting the hardware to the PC.
2. Always allow the install to fully complete (the software is a two-part installation, the ADC evaluation software and the [SDP-H1](#) drivers). A restart is recommended after installation is finished.
3. When the user first plugs in the [SDP-H1](#) board via the USB cable provided, allow the new Found Hardware Wizard to run, which may take a little time. However, allow this to happen before starting the software.
4. If the board does not appear to be functioning, ensure that the ADC evaluation board is connected to the [SDP-H1](#) board and that the board is being recognized in the Device Manager, as shown in Figure 14.
5. If connected to a slower USB port where the [SDP-H1](#) cannot read as quickly as it needs to, a timeout error may result. In this case, it is advised not to read continuously, or alternatively, to lower the number of samples taken.

HARDWARE

To troubleshoot the hardware, take the following steps:

1. If the software does not read any data back, do the following:
 - a. Check that the power is applied within the power ranges described in the Power Supplies section.
 - b. Using a voltmeter, measure the voltage present at each of the test points: $+V_s$, $-V_s$, 1P8V_VDD, VDD_1P8V, +3P3V, +5V, and REF1 and common-mode voltages (REF/2) at IN+ and IN- to ensure that they are correct. The [SDP-H1](#) board LED1 must be lit.
 - c. Launch the software and read the data. If nothing happens, exit the software.
 - d. Power down the board and relaunch the software.
 - e. If no data is read back, confirm that the ADC evaluation board is connected to the [SDP-H1](#) board and that the board is being recognized in the Device Manager, as shown in Figure 14.
2. When the user is working with the software in standalone/offline mode (no hardware connected) and later chooses to connect hardware, close and relaunch the software.

EVALUATION BOARD SCHEMATICS

Power supply for Amplifiers

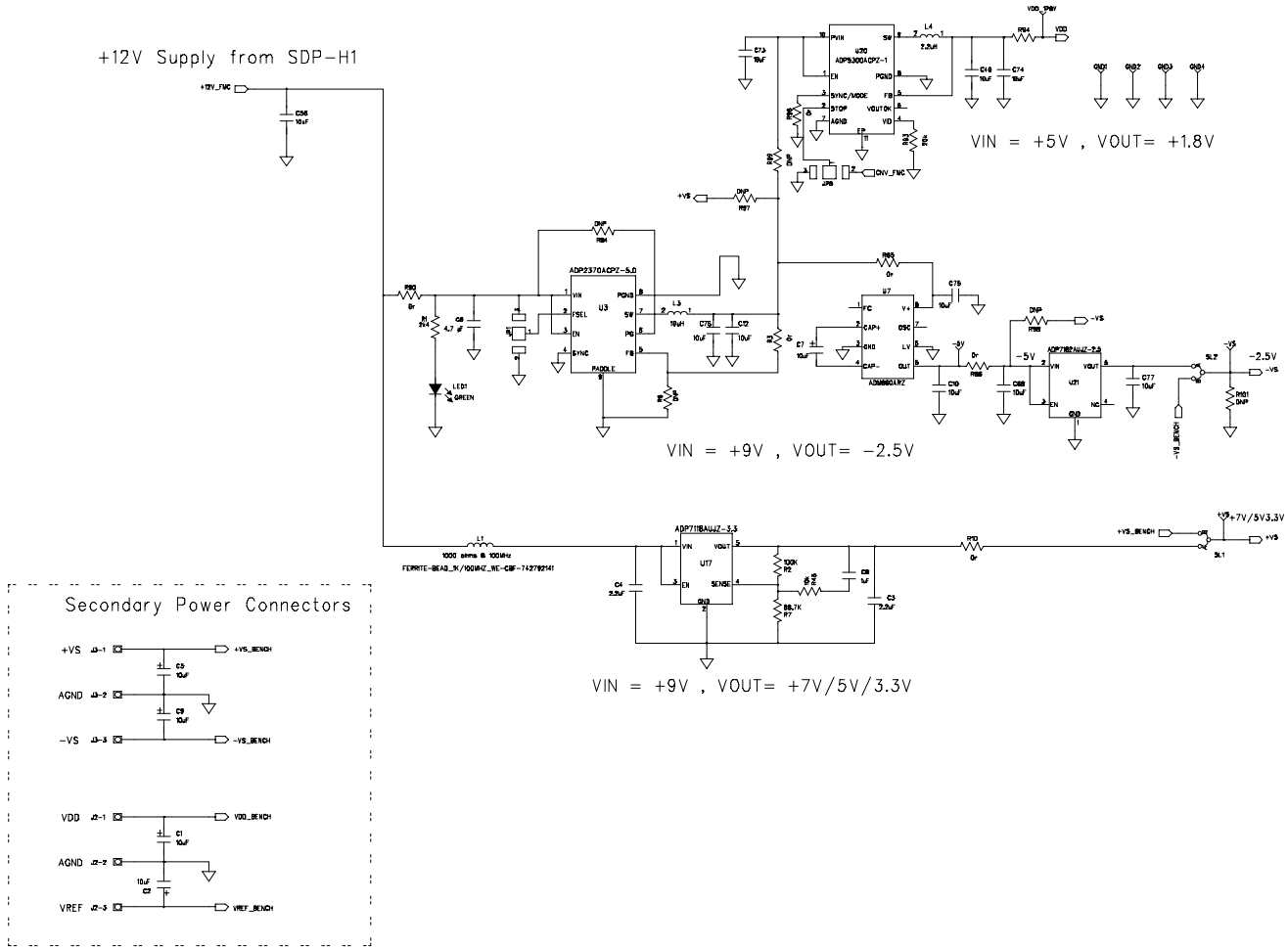
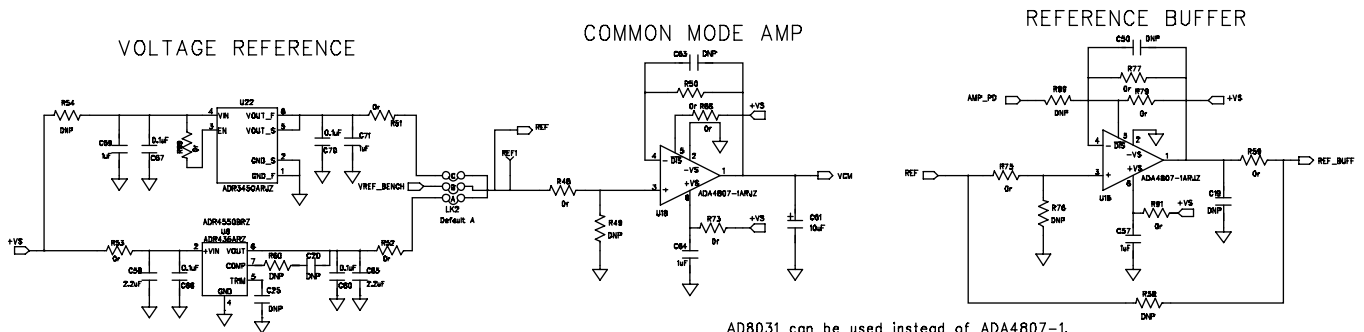
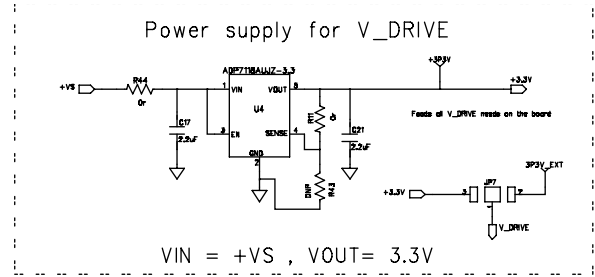
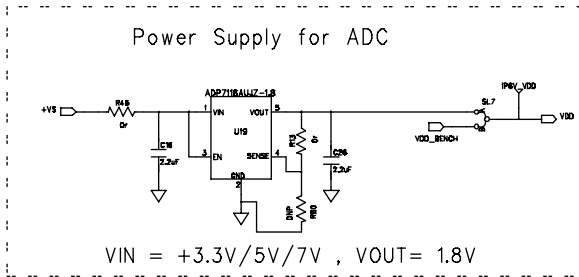

Figure 25. ADC Evaluation Board, Power Supplies

14981-023



The Voltage reference can be configured for either +5V or +2.5V.
 The ADR3450 (U22) can NOT accept input voltage more than 5.5V.

AD8031 can be used instead of ADA4807-1.

Figure 26. ADC Evaluation Board, Voltage Reference, Common-Mode and Reference Buffers

14981-1024

OPTIONAL HEADER CONNECTOR

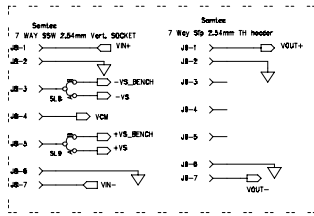

OPTIONAL HEADER CONNECTION EXTENDER CARD

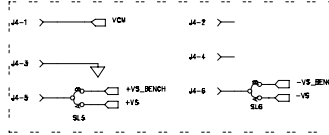

ANALOG INPUTS OPTION

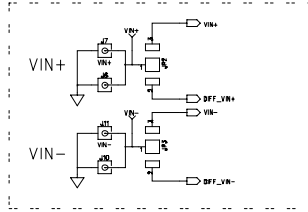

ADC DRIVERS

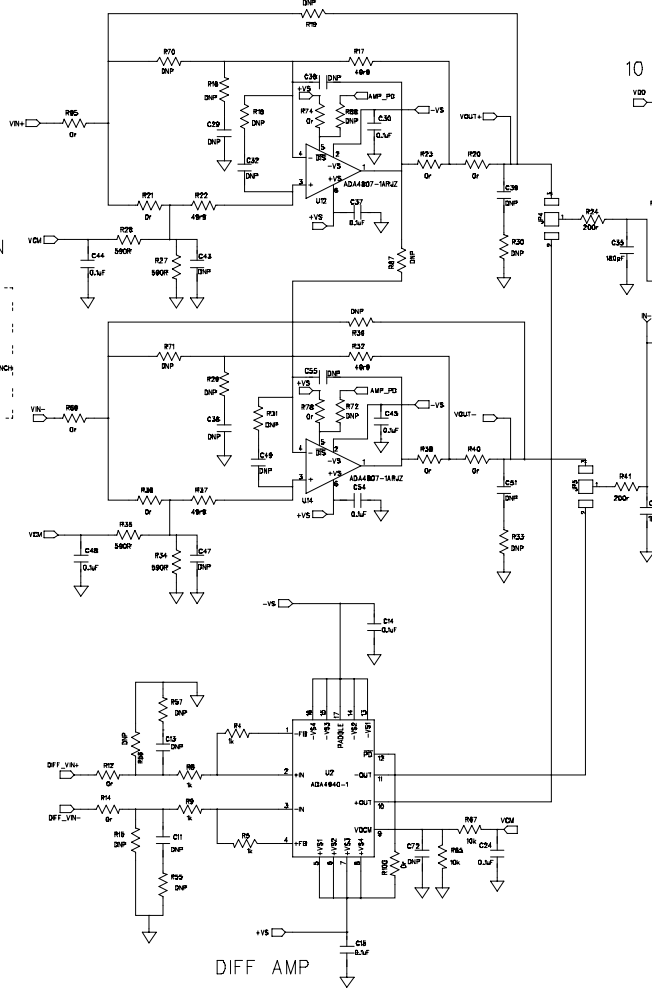

10 Lead PuISAR ADC

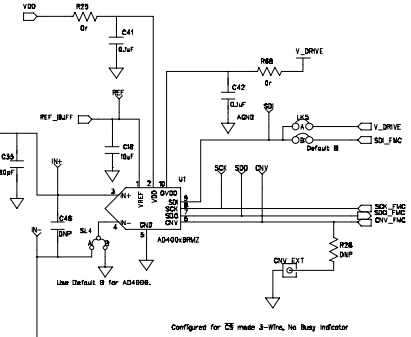

Figure 27. ADC Evaluation Board, ADC Drivers and ADC

FMC-LPC Male 160-Pin Connector

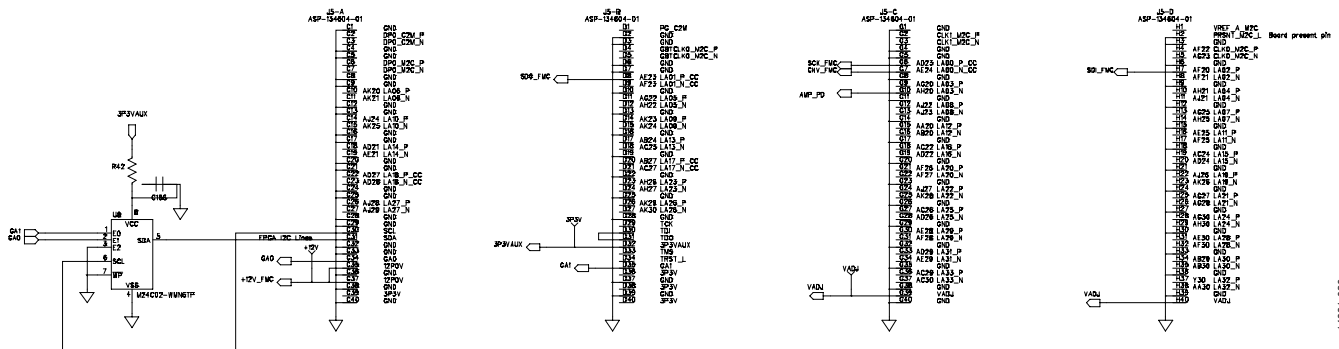

Figure 28. ADC Evaluation Board, SDP-H1 Connector and Glue Logic

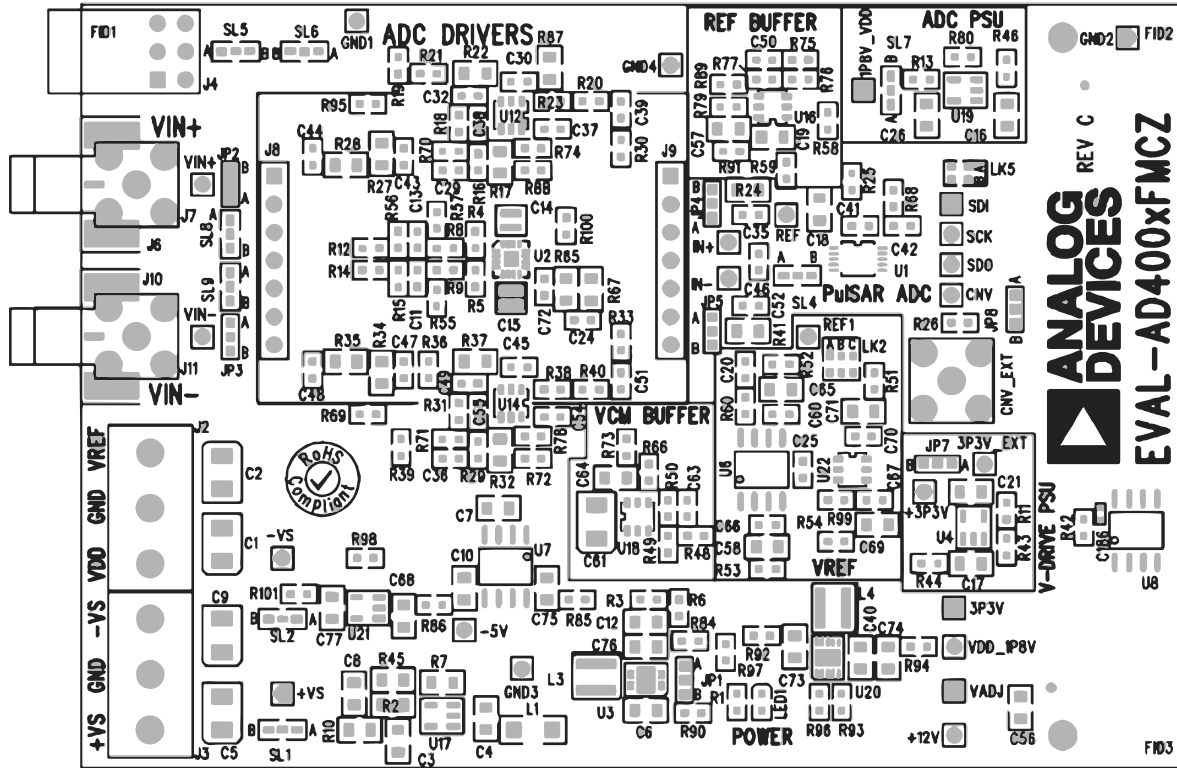

Figure 29. ADC Evaluation Board Silkscreen, Top Layer

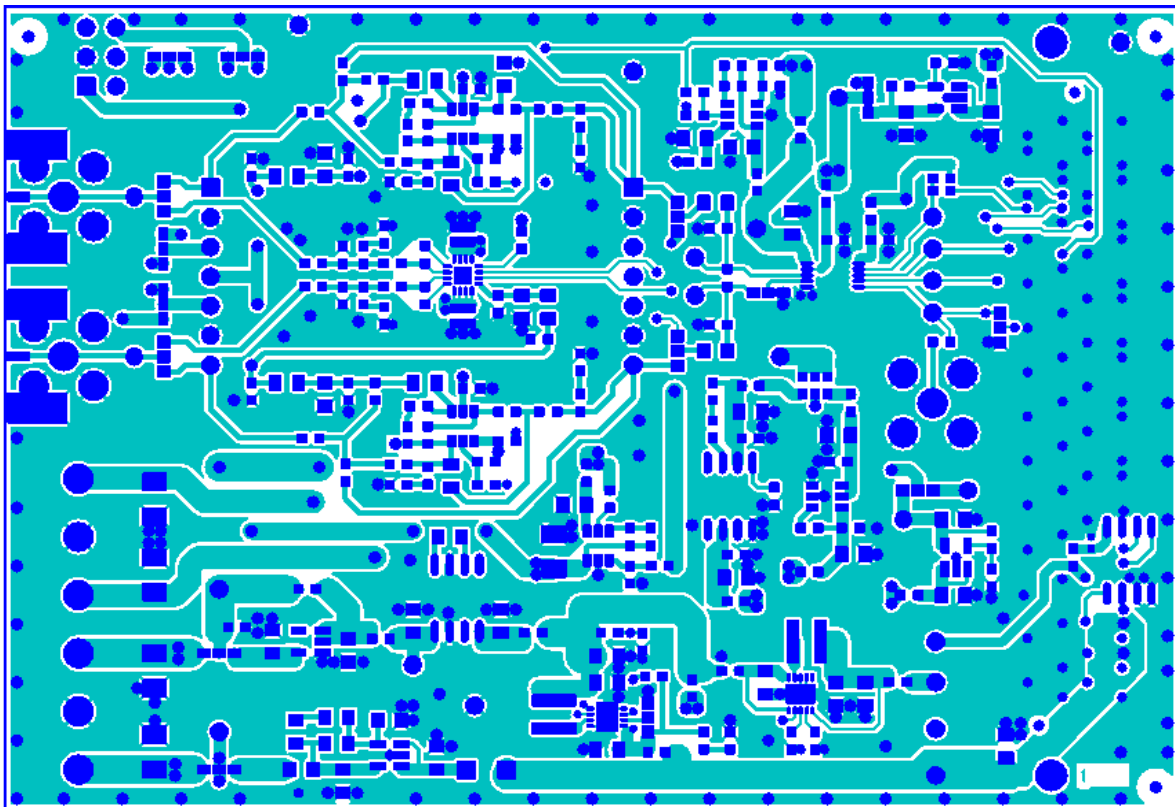
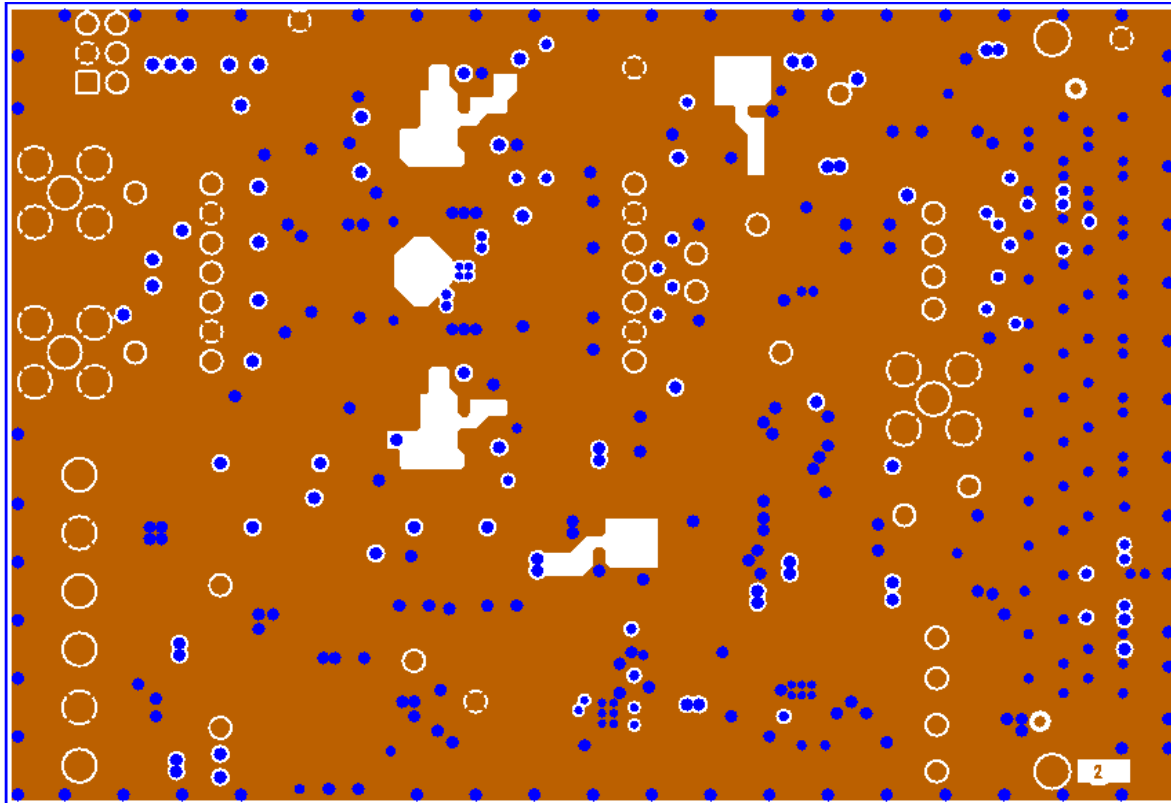

Figure 30. ADC Evaluation Board, Layer 1

14981-1027

14981-1028



14981-029

Figure 31. ADC Evaluation Board, Layer 2

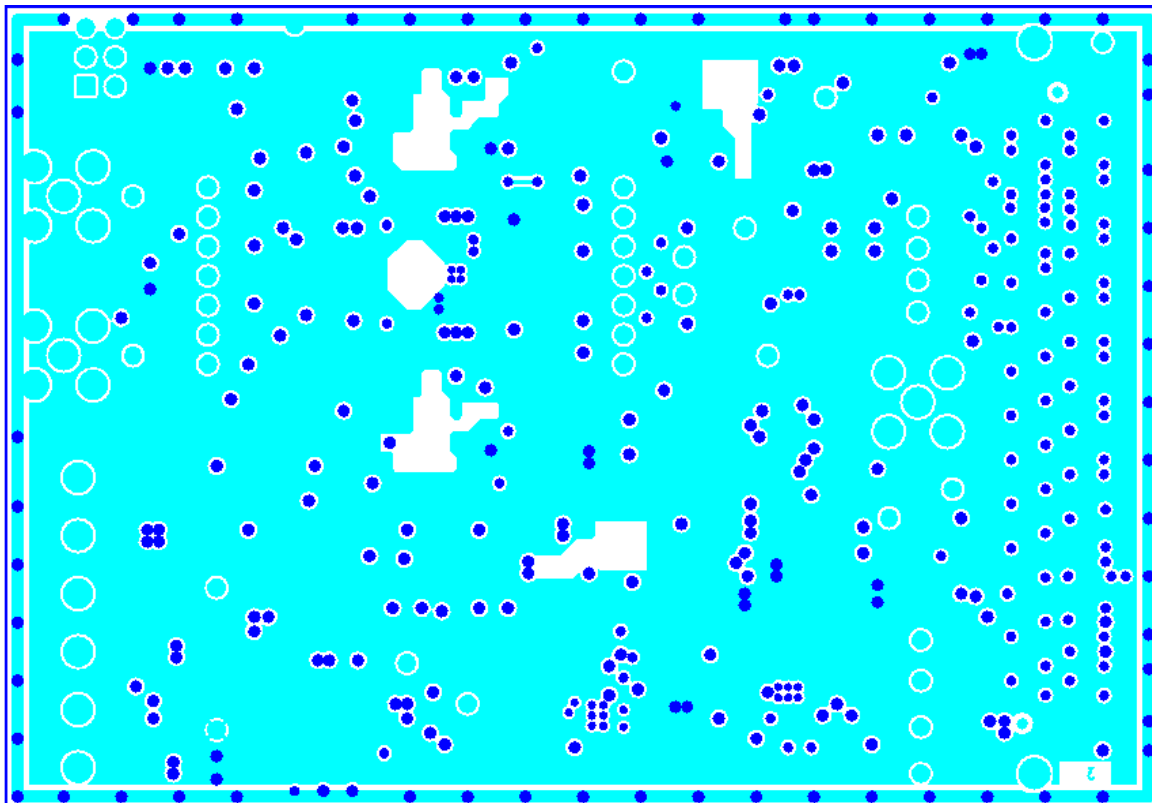

14981-030

Figure 32. ADC Evaluation Board, Layer 3

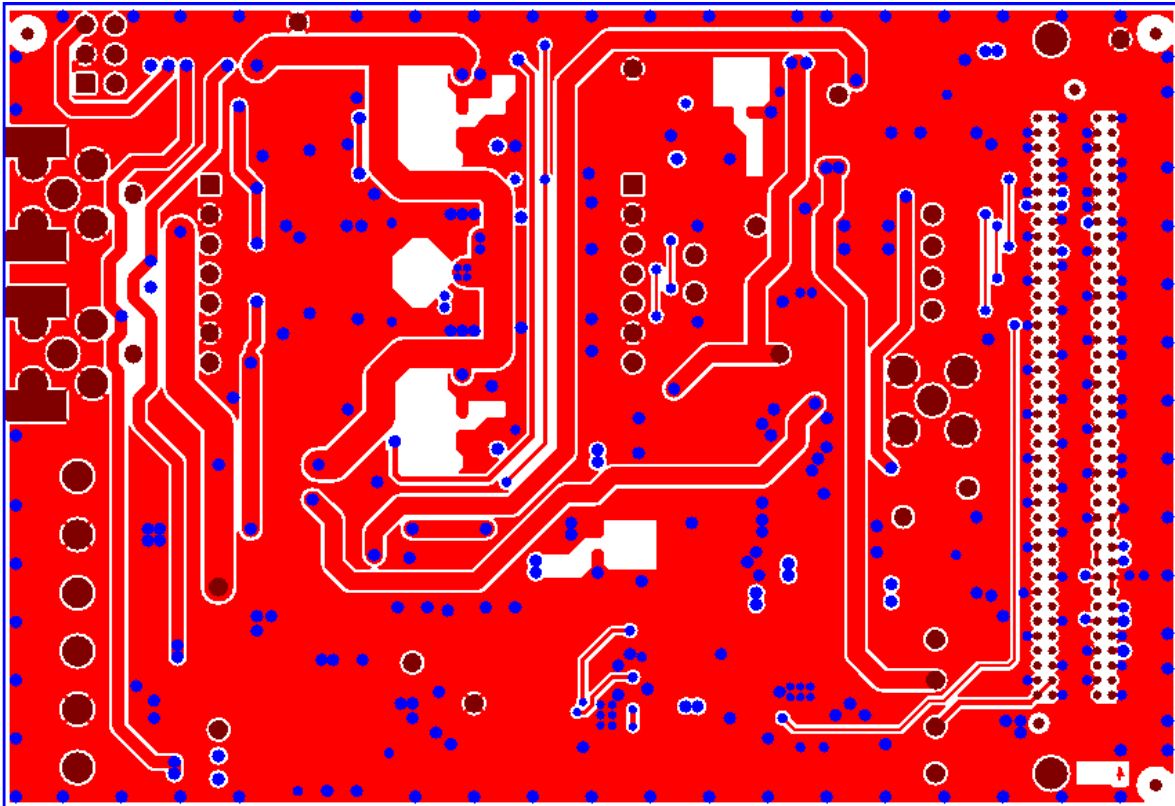

14891-081

Figure 33. ADC Evaluation Board, Layer 4

PRODUCTS ON THIS EVALUATION BOARD

AD4000/AD4001/AD4003 BILL OF MATERIALS

Table 5. Bill of Materials

Name	Part Description	Manufacturer	Part Number	Stock Code
U1	16-/18-bit, 2 MSPS, precision SAR ADC in 10-lead MSOP	Analog Devices	See Table 3	See Table 3
U2	Ultralow power, low distortion ADC driver, 4 nV/√Hz	Analog Devices	ADA4940-1	Do not place
U3	High voltage, 1.2 MHz/600 kHz, 800 mA, low quiescent current buck regulator	Analog Devices	ADP2370	ADP2370ACPZ-5.0-R7
U4	Linear regulator, 3.3 V, ultralow noise, CMOS	Analog Devices	ADP7118	ADP7118AUJZ-3.3-R7
U6	Ultralow noise, high accuracy voltage reference	Analog Devices	ADR4550	ADR4550BRZ
U7	CMOS, switched capacitor voltage converter	Analog Devices	ADM660	ADM660ARZ
U8	IC EEPROM, 2 kb, 400 kHz, 8-lead SOIC	ST	M24C02-WMN6TP	Digikey 497-8552-1-ND
U12, U14 (only for AD4001/AD4003)	Low noise, high speed amplifier	Analog Devices	ADA4807-1	ADA4807-1ARJZ
U12, U14 (only for AD4000)	Low noise, high speed amplifier	Analog Devices	ADA4805-1	ADA4805-1ARJZ
U16, U18	Low noise, high speed amplifier	Analog Devices	ADA4807-1	ADA4807-1ARJZ
U17	Linear regulator, 3.3 V, ultralow noise, CMOS	Analog Devices	ADP7118	ADP7118AUJZ-3.3-R7
U19	Linear regulator, 1.8 V, ultralow noise, CMOS	Analog Devices	ADP7118	ADP7118AUJZ-1.8-R7
U20	Ultralow power step-down regulator (ASHTON Lite)	Analog Devices	ADP5300	ADP5300ACPZ-1-R7
U21	-28 V, -200 mA, low noise, linear regulator	Analog Devices	ADP7182	ADP7182AUJ-2.5-R7
U22	Micropower, high accuracy, 5 V voltage reference	Analog Devices	ADR3450	ADR3450ARJZ-R2
C1, C2, C5, C9, C61	10 μF, 20 V tantalum capacitors	AVX	TAJB106K020RNJ	FEC 197427
C3, C4, C16, C17, C21, C26	2.2 μF, X7R, 16 V, 0805 capacitors, MLCC	Murata	GRM21BR71C225KA12L	FEC 1828829
C6	4.7 μF, 16 V, X7R, 0805 ceramic capacitor	Taiyo Yuden	EMK212B7475KG-T	FEC 1853520
C7, C10, C12, C18, C40, C68, C73, C74, C75, C76, C77	10 μF, 16 V, 0805 capacitors	Murata	GRM219R61C106KA73D	FEC 1845747
C8, C57, C64, C69, C71	1 μF, X7R, 50 V, 0805 capacitors	Murata	GRM21BR71H105KA12L	FEC 1735541
C14, C15	100 nF, X7R, 25 V, 0805 capacitors	Murata	LLL216R71E104MA01L	FEC 1294646
C24, C30, C37, C41, C42, C44, C45, C48, C54, C60, C66, C67, C70	0.1 μF, X7R, 50 V ceramic capacitors	Murata	GRM188R71H104KA93D	FEC 8820023
C35, C52	180 pF, 50 V, 0603, C0G/NP0 capacitors	YAGEO (Phycomp)	CC0603JRNPO9BN181	FEC 3019494
C11, C13, C19, C20, C25, C29, C32C36, C38, C39, C43, C46, C47, C49, C50, C51, C55, C63, C72	SMD capacitor	Not applicable	Not applicable	Do Not Place
C56	10 μF, X5R, 25 V, 0805, MLCC capacitor	Murata	GRM219R61E106KA12D	FEC 2426961
C58, C65	2.2 μF, 50 V, 0805, X7R capacitors	TDK	C2012X7R1H225K125AC	FEC 2346945

Name	Part Description	Manufacturer	Part Number	Stock Code
C186	SMD capacitor	EPCOS	B37921C9104K60	Digikey 495-3265-1-ND
L1	1000 Ω at 100 MHz, 1206, WE-CBF SMD, EMI suppression ferrite	Würth	742792141	WURTH 742792141
L3	10 μ H, inductor, shielded power, XAL40 series	Coilcraft	XAL4040-103ME	XAL4040-103ME
L4	2.2 μ H, inductor, shielded power, XAL40 series	Coilcraft	XAL4020-222MEB	COILCRAFT XAL4020-222MEB
LED1	LED, SMD green	OSRAM	LGQ971	Digikey 475-1409-1-ND
R1	2.4 k Ω , 0.063 W, 1%, 0603 resistor	Multicomp	MC0063W060312K4	FEC 9330879
R2	100 k Ω , 0.1 W, 1%, 0805 resistor	Multicomp	MC01W08051100K	FEC 9332405
R3, R11, R12, R13, R14, R20, R21, R23, R25, R36, R38, R40, R42, R44, R46, R48, R50, R51, R52, R53, R59, R66, R68, R69, R73, R74, R75, R77, R78, R79, R85, R86, R90, R91, R95, R96, R99, R100	0 Ω , SMD resistors	Multicomp	MC 0.063W 0603 0R	FEC 9331662
R4, R5, R8, R9	1 k Ω , 0.063 W, 1%, 0603 resistors	Multicomp	MC0063W060311K	FEC 9330380
R7	88.7 k Ω , 1%, 0805 resistors	Vishay Draloric	CRCW080588K7FKEA	FEC 2139026
R10	1%, 0805 resistors	Multicomp	MC01W08050R	FEC 9333681
R17, R22, R32, R37	49.9 Ω , 0.1 W, 0.1%, 0805 resistors	Panasonic	RN73C2A49R9BTG	FEC 1140694
R24, R41	200 Ω , 0.1 W, 1%, 0805 resistors	Multicomp	MC01W08051200R	FEC 9332758
R27, R28, R34, R35	Thick film chip resistor	Vishay Draloric	CRCW0805590RFKEA	FEC 1653021
R45, R65, R67	10 k Ω , 0.1 W, 1%, 0805 resistors	Multicomp	MC01W0805110K	FEC 9332391
R93	20 k Ω , 0.063 W, 1%, 0603 resistors	Multicomp	MC0063W0603120K	FEC 9330771
R6, R15, R16, R18, R19, R26, R29, R30, R31, R33, R39, R43, R49, R54, R55, R56, R57, R58, R60, R70, R71, R72, R76, R80, R84, R87, R88, R89, R92, R94, R97, R98, R101	SMD resistors, 0603	Not applicable	Not applicable	Do not place

Table 6. Evaluation Board Models

Product	Ordering Model	Sample Rate (MSPS)	Resolution (Bits)	Package Used on Evaluation Board
AD4000BRMZ	EVAL-AD4000FMCZ	2	18	10-lead MSOP
AD4003BRMZ	EVAL-AD4003FMCZ	2	16	10-lead MSOP
AD4001BRMZ	EVAL-AD4001FMCZ	2	16	10-lead MSOP

RELATED LINKS

Resource	Description
ADA4805-1	Product Page, ADA4805-1 , 0.2 μ V/ $^{\circ}$ C Offset Drift, 105 MHz Low Power, Low Noise, Rail-to-Rail Amplifier
ADA4807-1	Product Page, ADA4807-1 , Low Power, Low Noise and Distortion, Rail-to-Rail Output Amplifier
ADR4550	Product Page, ADR4550 , Ultralow Noise, High Accuracy 5.0 V Voltage Reference
ADP7118	Product Page, ADP7118 , 20 V, 200 mA, Low Noise, CMOS LDO
ADP7182	Product Page, ADP7182 , -28 V, 200 mA, Low Noise, Linear Regulator
ADM660	Product Page, ADM660 , CMOS Switched Capacitor Voltage Converter
ADP2370	Product Page, ADP2370 , High Voltage, 1.2 MHz/600 kHz, 800 mA, Low Quiescent Current Buck Regulator
EVAL-SDP-CH1Z	Product Page, High-Speed Controller Board for System Demonstration Platform (SDP-H1)
AN-931	AN-931 Application Note , <i>Understanding PulSAR ADC Support Circuitry</i>

NOTES

**ESD Caution**

ESD (electrostatic discharge) sensitive device. Charged devices and circuit boards can discharge without detection. Although this product features patented or proprietary protection circuitry, damage may occur on devices subjected to high energy ESD. Therefore, proper ESD precautions should be taken to avoid performance degradation or loss of functionality.

Legal Terms and Conditions

By using the evaluation board discussed herein (together with any tools, components documentation or support materials, the "Evaluation Board"), you are agreeing to be bound by the terms and conditions set forth below ("Agreement") unless you have purchased the Evaluation Board, in which case the Analog Devices Standard Terms and Conditions of Sale shall govern. Do not use the Evaluation Board until you have read and agreed to the Agreement. Your use of the Evaluation Board shall signify your acceptance of the Agreement. This Agreement is made by and between you ("Customer") and Analog Devices, Inc. ("ADI"), with its principal place of business at One Technology Way, Norwood, MA 02062, USA. Subject to the terms and conditions of the Agreement, ADI hereby grants to Customer a free, limited, personal, temporary, non-exclusive, non-sublicensable, non-transferable license to use the Evaluation Board FOR EVALUATION PURPOSES ONLY. Customer understands and agrees that the Evaluation Board is provided for the sole and exclusive purpose referenced above, and agrees not to use the Evaluation Board for any other purpose. Furthermore, the license granted is expressly made subject to the following additional limitations: Customer shall not (i) rent, lease, display, sell, transfer, assign, sublicense, or distribute the Evaluation Board; and (ii) permit any Third Party to access the Evaluation Board. As used herein, the term "Third Party" includes any entity other than ADI, Customer, their employees, affiliates and in-house consultants. The Evaluation Board is NOT sold to Customer; all rights not expressly granted herein, including ownership of the Evaluation Board, are reserved by ADI. CONFIDENTIALITY. This Agreement and the Evaluation Board shall all be considered the confidential and proprietary information of ADI. Customer may not disclose or transfer any portion of the Evaluation Board to any other party for any reason. Upon discontinuation of use of the Evaluation Board or termination of this Agreement, Customer agrees to promptly return the Evaluation Board to ADI. ADDITIONAL RESTRICTIONS. Customer may not disassemble, decompile or reverse engineer chips on the Evaluation Board. Customer shall inform ADI of any occurred damages or any modifications or alterations it makes to the Evaluation Board, including but not limited to soldering or any other activity that affects the material content of the Evaluation Board. Modifications to the Evaluation Board must comply with applicable law, including but not limited to the RoHS Directive. TERMINATION. ADI may terminate this Agreement at any time upon giving written notice to Customer. Customer agrees to return to ADI the Evaluation Board at that time. LIMITATION OF LIABILITY. THE EVALUATION BOARD PROVIDED HEREUNDER IS PROVIDED "AS IS" AND ADI MAKES NO WARRANTIES OR REPRESENTATIONS OF ANY KIND WITH RESPECT TO IT. ADI SPECIFICALLY DISCLAIMS ANY REPRESENTATIONS, ENDORSEMENTS, GUARANTEES, OR WARRANTIES, EXPRESS OR IMPLIED, RELATED TO THE EVALUATION BOARD INCLUDING, BUT NOT LIMITED TO, THE IMPLIED WARRANTY OF MERCHANTABILITY, TITLE, FITNESS FOR A PARTICULAR PURPOSE OR NON-INFRINGEMENT OF INTELLECTUAL PROPERTY RIGHTS. IN NO EVENT WILL ADI AND ITS LICENSORS BE LIABLE FOR ANY INCIDENTAL, SPECIAL, INDIRECT, OR CONSEQUENTIAL DAMAGES RESULTING FROM CUSTOMER'S POSSESSION OR USE OF THE EVALUATION BOARD, INCLUDING BUT NOT LIMITED TO LOST PROFITS, DELAY COSTS, LABOR COSTS OR LOSS OF GOODWILL. ADI'S TOTAL LIABILITY FROM ANY AND ALL CAUSES SHALL BE LIMITED TO THE AMOUNT OF ONE HUNDRED US DOLLARS (\$100.00). EXPORT. Customer agrees that it will not directly or indirectly export the Evaluation Board to another country, and that it will comply with all applicable United States federal laws and regulations relating to exports. GOVERNING LAW. This Agreement shall be governed by and construed in accordance with the substantive laws of the Commonwealth of Massachusetts (excluding conflict of law rules). Any legal action regarding this Agreement will be heard in the state or federal courts having jurisdiction in Suffolk County, Massachusetts, and Customer hereby submits to the personal jurisdiction and venue of such courts. The United Nations Convention on Contracts for the International Sale of Goods shall not apply to this Agreement and is expressly disclaimed.