



Chipsmall Limited consists of a professional team with an average of over 10 year of expertise in the distribution of electronic components. Based in Hongkong, we have already established firm and mutual-benefit business relationships with customers from,Europe,America and south Asia,supplying obsolete and hard-to-find components to meet their specific needs.

With the principle of "Quality Parts,Customers Priority,Honest Operation,and Considerate Service",our business mainly focus on the distribution of electronic components. Line cards we deal with include Microchip,ALPS,ROHM,Xilinx,Pulse,ON,Everlight and Freescale. Main products comprise IC,Modules,Potentiometer,IC Socket,Relay,Connector.Our parts cover such applications as commercial,industrial, and automotives areas.

We are looking forward to setting up business relationship with you and hope to provide you with the best service and solution. Let us make a better world for our industry!



## Contact us

Tel: +86-755-8981 8866 Fax: +86-755-8427 6832

Email & Skype: info@chipsmall.com Web: www.chipsmall.com

Address: A1208, Overseas Decoration Building, #122 Zhenhua RD., Futian, Shenzhen, China



### FEATURES

- 40-channel DAC in a 64-lead LFCSP and a 64-lead LQFP
- Guaranteed monotonic to 16 bits
- Maximum output voltage span of  $4 \times V_{REF}$  (20 V)
- Nominal output voltage span of  $-4\text{ V}$  to  $+8\text{ V}$
- Multiple, independent output spans available
- System calibration function allowing user-programmable offset and gain
- Channel grouping and addressing features
- Thermal shutdown function
- DSP/microcontroller-compatible serial interface
- SPI serial interface

2.5 V to 5.5 V digital interface

Digital reset ( $\overline{\text{RESET}}$ )

Clear function to user-defined  $\text{SIGGND}_x$

Simultaneous update of DAC outputs

### APPLICATIONS

Level setting in automatic test equipment (ATE)

Variable optical attenuators (VOA)

Optical switches

Industrial control systems

Instrumentation

### FUNCTIONAL BLOCK DIAGRAM

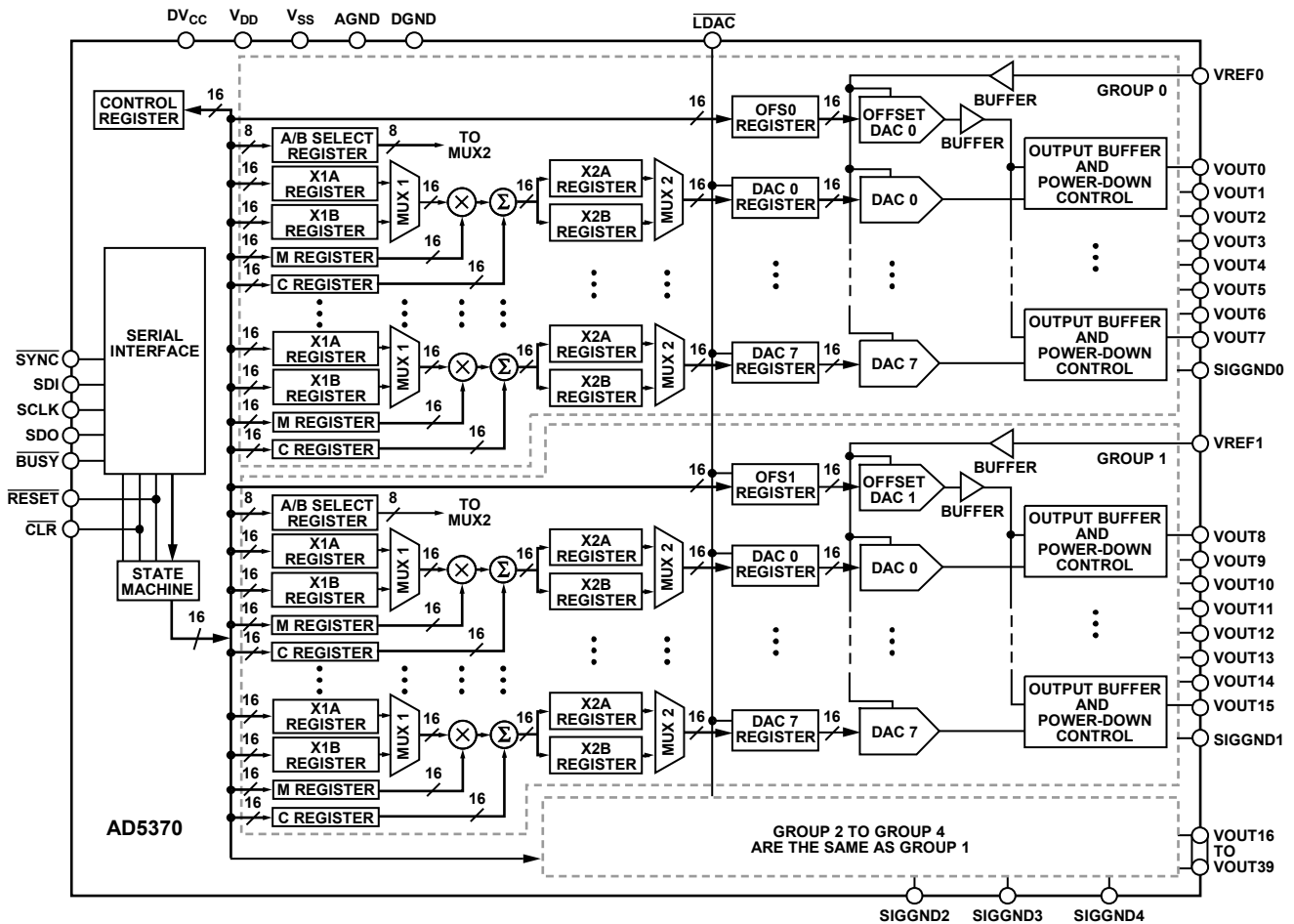

Figure 1.

### Rev. 0

Information furnished by Analog Devices is believed to be accurate and reliable. However, no responsibility is assumed by Analog Devices for its use, nor for any infringements of patents or other rights of third parties that may result from its use. Specifications subject to change without notice. No license is granted by implication or otherwise under any patent or patent rights of Analog Devices. Trademarks and registered trademarks are the property of their respective owners.

One Technology Way, P.O. Box 9106, Norwood, MA 02062-9106, U.S.A.

Tel: 781.329.4700

Fax: 781.461.3113

[www.analog.com](http://www.analog.com)

©2008 Analog Devices, Inc. All rights reserved.

# AD5370\* PRODUCT PAGE QUICK LINKS

Last Content Update: 02/23/2017

---

## COMPARABLE PARTS

View a parametric search of comparable parts.

## EVALUATION KITS

- AD5370 Evaluation Board

## DOCUMENTATION

### Application Notes

- AN-1036: Clear to Any Voltage Using the AD5370
- AN-1215: 40 Channels of Programmable Industrial Level Output Span Using the AD5370 16-Bit Voltage Output DAC

### Data Sheet

- AD5370: 40-Channel, 16-Bit, Serial Input, Voltage-Output DACs Data Sheet

### Product Highlight

- Extending the *denseDAC*™ Multichannel D/As

## SOFTWARE AND SYSTEMS REQUIREMENTS

- AD5360 IIO Multi-Channel DAC Linux Driver
- AD5370/AD5371/AD5372/AD5373 Evaluation Software

## REFERENCE MATERIALS

### Product Selection Guide

- AD536x, AD537x Family Product Selection Guide

### Solutions Bulletins & Brochures

- Digital to Analog Converters ICs Solutions Bulletin

## DESIGN RESOURCES

- AD5370 Material Declaration
- PCN-PDN Information
- Quality And Reliability
- Symbols and Footprints

## DISCUSSIONS

View all AD5370 EngineerZone Discussions.

## SAMPLE AND BUY

Visit the product page to see pricing options.

## TECHNICAL SUPPORT

Submit a technical question or find your regional support number.

## DOCUMENT FEEDBACK

Submit feedback for this data sheet.

---

## TABLE OF CONTENTS

Features .....	1	Transfer Function .....	17
Applications .....	1	Reference Selection .....	17
Functional Block Diagram .....	1	Calibration .....	18
Revision History .....	2	Additional Calibration .....	18
General Description .....	3	Reset Function .....	19
Specifications .....	4	Clear Function .....	19
Performance Specifications .....	4	$\overline{\text{BUSY}}$ and $\overline{\text{LDAC}}$ Functions .....	19
AC Characteristics .....	5	Power-Down Mode .....	19
Timing Characteristics .....	6	Thermal Shutdown Function .....	19
Timing Diagrams .....	6	Toggle Mode .....	20
Absolute Maximum Ratings .....	9	Serial Interface .....	21
ESD Caution .....	9	SPI Write Mode .....	21
Pin Configurations and Function Descriptions .....	10	SPI Readback Mode .....	21
Typical Performance Characteristics .....	12	Register Update Rates .....	21
Terminology .....	14	Channel Addressing and Special Modes .....	21
Theory of Operation .....	15	Special Function Mode .....	23
DAC Architecture .....	15	Power Supply Decoupling .....	25
Channel Groups .....	15	Power Supply Sequencing .....	25
$\overline{\text{A/B}}$ Registers and Gain/Offset Adjustment .....	16	Interfacing Examples .....	26
Load DAC .....	16	Outline Dimensions .....	27
Offset DAC Channels .....	16	Ordering Guide .....	27
Output Amplifier .....	17		

## REVISION HISTORY

4/08—Revision 0: Initial Version



## GENERAL DESCRIPTION

The AD5370<sup>1</sup> contains forty 16-bit DACs in a single 64-lead LFCSP and a 64-lead LQFP. The device provides buffered voltage outputs with a span that is 4× the reference voltage. The gain and offset of each DAC channel can be independently trimmed to remove errors. For even greater flexibility, the device is divided into five groups of eight DACs. Three offset DAC channels allow the output range of blocks to be adjusted. Group 0 can be adjusted by Offset DAC 0, Group 1 can be adjusted by Offset DAC 1, and Group 2 to Group 4 can be adjusted by Offset DAC 2.

The AD5370 offers guaranteed operation over a wide supply range, with  $V_{SS}$  from  $-16.5\text{ V}$  to  $-4.5\text{ V}$  and  $V_{DD}$  from  $+9\text{ V}$  to  $+16.5\text{ V}$ . The output amplifier headroom requirement is  $1.4\text{ V}$  operating with a load current of  $1\text{ mA}$ .

<sup>1</sup> Protected by U.S. Patent No. 5,969,657; other patents pending.

The AD5370 has a high speed serial interface that is compatible with SPI, QSPI™, MICROWIRE™, and DSP interface standards and can handle clock speeds of up to 50 MHz.

The DAC registers are updated on receipt of new data. All the outputs can be updated simultaneously by taking the  $\overline{\text{LDAC}}$  input low. Each channel has a programmable gain and an offset adjust register to allow removal of gain and offset errors.

Each DAC output is gained and buffered on chip with respect to an external SIGGNDx input. The DAC outputs can also be switched to SIGGNDx via the  $\overline{\text{CLR}}$  pin.

**Table 1. High Channel Count Bipolar DACs**

Model	Resolution	Nominal Output Span	Output Channels	Linearity Error (LSB)
AD5360	16 bits	$4 \times V_{REF}$ (20 V)	16	±4
AD5361	14 bits	$4 \times V_{REF}$ (20 V)	16	±1
AD5362	16 bits	$4 \times V_{REF}$ (20 V)	8	±4
AD5363	14 bits	$4 \times V_{REF}$ (20 V)	8	±1
AD5370	16 bits	$4 \times V_{REF}$ (12 V)	40	±4
AD5371	14 bits	$4 \times V_{REF}$ (12 V)	40	±1
AD5372	16 bits	$4 \times V_{REF}$ (12 V)	32	±4
AD5373	14 bits	$4 \times V_{REF}$ (12 V)	32	±1
AD5378	14 bits	±8.75 V	32	±3
AD5379	14 bits	±8.75 V	40	±3

## SPECIFICATIONS

### PERFORMANCE SPECIFICATIONS

$DV_{CC} = 2.5\text{ V to }5.5\text{ V}$ ;  $V_{DD} = 9\text{ V to }16.5\text{ V}$ ;  $V_{SS} = -16.5\text{ V to }-8\text{ V}$ ;  $V_{REF} = 3\text{ V}$ ;  $AGND = DGND = SIGGND = 0\text{ V}$ ;  $C_L = \text{open circuit}$ ;  $R_L = \text{open circuit}$ ; gain (M), offset (C), and DAC offset registers at default values; all specifications  $T_{MIN}$  to  $T_{MAX}$ , unless otherwise noted.

Table 2.

Parameter	Min	Type	Max	Unit	Test Conditions/Comments <sup>1</sup>
<b>ACCURACY</b>					
Resolution	16			Bits	
Integral Nonlinearity	-4		+4	LSB	
Differential Nonlinearity	-1		+1	LSB	Guaranteed monotonic by design
Zero-Scale Error	-10		+10	mV	Before calibration
Full-Scale Error	-10		+10	mV	Before calibration
Gain Error			0.1	% FSR	
Zero-Scale Error <sup>2</sup>		1		LSB	After calibration
Full-Scale Error <sup>2</sup>		1		LSB	After calibration
Span Error of Offset DAC	-35		+35	mV	See the Offset DAC Channels section for details
VOUT Temperature Coefficient (VOUT0 to VOUT39)		5		ppm FSR/°C	Includes linearity, offset, and gain drift
DC Crosstalk <sup>2</sup>			120	μV	Typically 20 μV; measured channel at midscale, full-scale change on any other channel
<b>REFERENCE INPUTS (VREF0, VREF1)<sup>2</sup></b>					
VREF Input Current	-10		+10	μA	Per input, typically ±30 nA
VREF Range	2		5	V	±2% for specified operation
<b>SIGGND INPUT (SIGGND0 to SIGGND4)<sup>2</sup></b>					
DC Input Impedance	50			kΩ	Typically 55 kΩ
Input Range	-0.5		+0.5	V	
SIGGND Gain	0.995		1.005		
<b>OUTPUT CHARACTERISTICS<sup>2</sup></b>					
Output Voltage Range	$V_{SS} + 1.4$		$V_{DD} - 1.4$	V	$I_{LOAD} = 1\text{ mA}$
Nominal Output Voltage Range	-4		+8	V	
Short-Circuit Current			15	mA	$V_{OUTx}$ to $DV_{CC}$ , $V_{DD}$ , or $V_{SS}$
Load Current	-1		+1	mA	
Capacitive Load			2200	pF	
DC Output Impedance			0.5		
<b>DIGITAL INPUTS</b>					
Input High Voltage	1.7			V	$DV_{CC} = 2.5\text{ V to }3.6\text{ V}$
	2.0			V	$DV_{CC} = 3.6\text{ V to }5.5\text{ V}$
Input Low Voltage			0.8	V	$DV_{CC} = 2.5\text{ V to }5.5\text{ V}$
Input Current	-1		+1	μA	Excluding the CLR pin
CLR High Impedance Leakage Current	-20		+20	μA	
Input Capacitance <sup>2</sup>			10	pF	
<b>DIGITAL OUTPUTS (SDO, BUSY)</b>					
Output Low Voltage			0.5	V	Sinking 200 μA
Output High Voltage (SDO)	$DV_{CC} - 0.5$			V	Sourcing 200 μA
SDO High Impedance Leakage Current	-5		+5	μA	
High Impedance Output Capacitance <sup>2</sup>		10		pF	

Parameter	Min	Type	Max	Unit	Test Conditions/Comments <sup>1</sup>
<b>POWER REQUIREMENTS</b>					
DV <sub>CC</sub>	2.5		5.5	V	
V <sub>DD</sub>	9		16.5	V	
V <sub>SS</sub>	-16.5		-4.5	V	
<b>Power Supply Sensitivity<sup>2</sup></b>					
ΔFull Scale/ΔV <sub>DD</sub>		-75		dB	
ΔFull Scale/ΔV <sub>SS</sub>		-75		dB	
ΔFull Scale/ΔDV <sub>CC</sub>		-90		dB	
DI <sub>CC</sub>			2	mA	DV <sub>CC</sub> = 5.5 V, V <sub>IH</sub> = DV <sub>CC</sub> , V <sub>IL</sub> = GND; normal operating conditions
I <sub>DD</sub>			18	mA	Outputs unloaded, DAC outputs = 0 V
			20	mA	Outputs unloaded, DAC outputs = full scale
I <sub>SS</sub>			-18	mA	Outputs unloaded, DAC outputs = 0 V
			-20	mA	Outputs unloaded, DAC outputs = full scale
Power Dissipation Unloaded (P)		280		mW	V <sub>SS</sub> = -8 V, V <sub>DD</sub> = +9.5 V, DV <sub>CC</sub> = 2.5 V
<b>Power-Down Mode</b>					
DI <sub>CC</sub>		5		μA	Control register power-down bit set
I <sub>DD</sub>		35		μA	
I <sub>SS</sub>		-35		μA	
Junction Temperature <sup>3</sup>			130	°C	T <sub>J</sub> = T <sub>A</sub> + P <sub>TOTAL</sub> × θ <sub>JA</sub>

<sup>1</sup> Temperature range for the AD5370 is -40°C to +85°C. Typical specifications are at 25°C.

<sup>2</sup> Guaranteed by design and characterization, not production tested.

<sup>3</sup> Where θ<sub>JA</sub> represents the package thermal impedance.

## AC CHARACTERISTICS

DV<sub>CC</sub> = 2.5 V; V<sub>DD</sub> = 15 V; V<sub>SS</sub> = -15 V; VREF0 = VREF1 = 3 V; AGND = DGND = SIGGND = 0 V; C<sub>L</sub> = 200 pF; R<sub>L</sub> = 10 kΩ; gain (M), offset (C), and DAC offset registers at default values; all specifications T<sub>MIN</sub> to T<sub>MAX</sub>, unless otherwise noted.

**Table 3. AC Characteristics<sup>1</sup>**

Parameter	Min	Typ	Max	Unit	Test Conditions/Comments
<b>DYNAMIC PERFORMANCE</b>					
Output Voltage Settling Time		20		μs	Settling to 1 LSB from a full-scale change
			30	μs	DAC latch contents alternately loaded with all 0s and all 1s
Slew Rate		1		V/μs	
Digital-to-Analog Glitch Energy		5		nV-s	
Glitch Impulse Peak Amplitude			10	mV	
Channel-to-Channel Isolation		100		dB	VREF0 = VREF1 = 2 V p-p, 1 kHz
DAC-to-DAC Crosstalk		20		nV-s	
Digital Crosstalk		0.2		nV-s	
Digital Feedthrough		0.02		nV-s	Effect of input bus activity on DAC output under test
Output Noise Spectral Density @ 10 kHz		250		nV/√Hz	VREF0 = VREF1 = 0 V

<sup>1</sup> Guaranteed by design and characterization, not production tested.

## TIMING CHARACTERISTICS

$DV_{CC} = 2.5\text{ V to }5.5\text{ V}$ ;  $V_{DD} = 9\text{ V to }16.5\text{ V}$ ;  $V_{SS} = -16.5\text{ V to }-4.5\text{ V}$ ;  $V_{REF} = 3\text{ V}$ ;  $AGND = DGND = SIGGND = 0\text{ V}$ ;  $C_L = 200\text{ pF to GND}$ ;  $R_L = \text{open circuit}$ ; gain (M), offset (C), and DAC offset registers at default values; all specifications  $T_{MIN}$  to  $T_{MAX}$ , unless otherwise noted.

**Table 4. SPI Interface**

Parameter <sup>1,2,3</sup>	Limit at $T_{MIN}, T_{MAX}$			Unit	Description
	Min	Typ	Max		
$t_1$	20			ns	SCLK cycle time
$t_2$	8			ns	SCLK high time
$t_3$	8			ns	SCLK low time
$t_4$	11			ns	$\overline{\text{SYNC}}$ falling edge to SCLK falling edge setup time
$t_5$	20			ns	Minimum $\overline{\text{SYNC}}$ high time
$t_6$	10			ns	24 <sup>th</sup> SCLK falling edge to $\overline{\text{SYNC}}$ rising edge
$t_7$	5			ns	Data setup time
$t_8$	5			ns	Data hold time
$t_9^4$			42	ns	$\overline{\text{SYNC}}$ rising edge to $\overline{\text{BUSY}}$ falling edge
$t_{10}$			1.5	$\mu\text{s}$	$\overline{\text{BUSY}}$ pulse width low (single-channel update); see Table 8
$t_{11}$			600	ns	Single-channel update cycle time
$t_{12}$	20			ns	$\overline{\text{SYNC}}$ rising edge to $\overline{\text{LDAC}}$ falling edge
$t_{13}$	10			ns	$\overline{\text{LDAC}}$ pulse width low
$t_{14}$			3	$\mu\text{s}$	$\overline{\text{BUSY}}$ rising edge to DAC output response time
$t_{15}$	0			ns	$\overline{\text{BUSY}}$ rising edge to $\overline{\text{LDAC}}$ falling edge
$t_{16}$			3	$\mu\text{s}$	$\overline{\text{LDAC}}$ falling edge to DAC output response time
$t_{17}$		20	30	$\mu\text{s}$	DAC output settling time
$t_{18}$			140	ns	$\overline{\text{CLR/RESET}}$ pulse activation time
$t_{19}$	30			ns	$\overline{\text{RESET}}$ pulse width low
$t_{20}$			400	$\mu\text{s}$	$\overline{\text{RESET}}$ time indicated by $\overline{\text{BUSY}}$ low
$t_{21}$	270			ns	Minimum $\overline{\text{SYNC}}$ high time in readback mode
$t_{22}^5$			25	ns	SCLK rising edge to SDO valid
$t_{23}$			80	ns	$\overline{\text{RESET}}$ rising edge to $\overline{\text{BUSY}}$ falling edge

<sup>1</sup> Guaranteed by design and characterization, not production tested.

<sup>2</sup> All input signals are specified with  $t_r = t_f = 2\text{ ns}$  (10% to 90% of  $DV_{CC}$ ) and timed from a voltage level of 1.2 V.

<sup>3</sup> See Figure 4 and Figure 5.

<sup>4</sup> This is measured with the load circuit shown in Figure 2.

<sup>5</sup> This is measured with the load circuit shown in Figure 3.

## TIMING DIAGRAMS

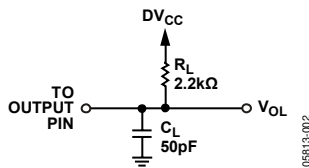

Figure 2. Load Circuit for  $\overline{\text{BUSY}}$  Timing Diagram

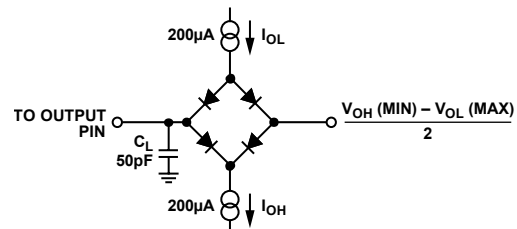
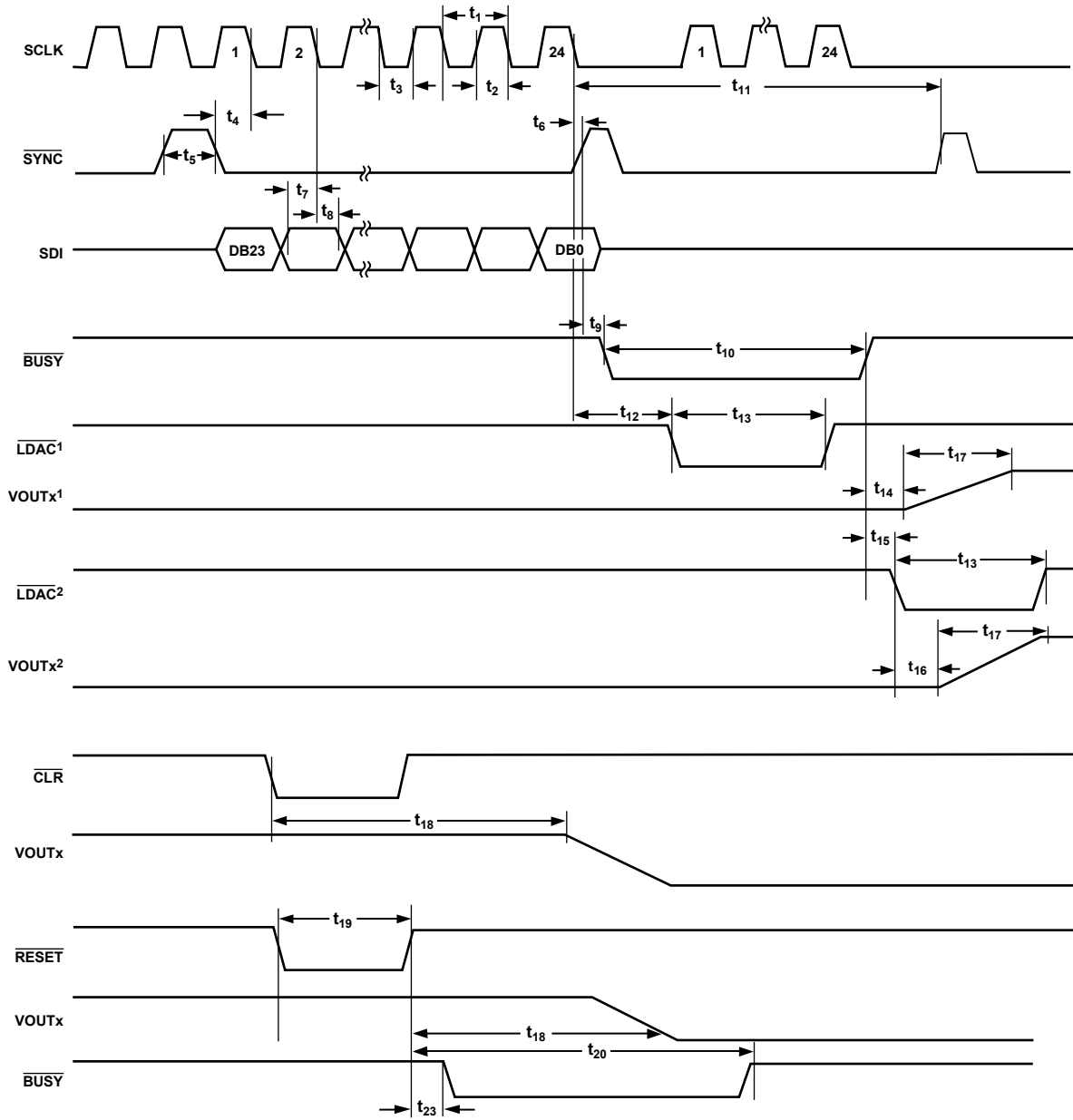

Figure 3. Load Circuit for SDO Timing Diagram





1 LDAC ACTIVE DURING BUSY.  
 2 LDAC ACTIVE AFTER BUSY.

Figure 4. SPI Write Timing

05813-004

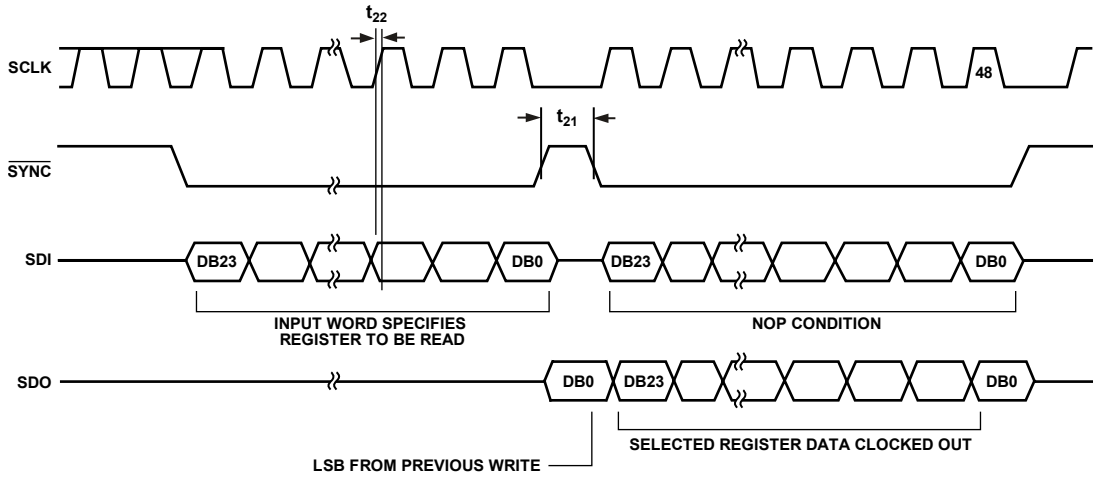

Figure 5. SPI Read Timing

05813-005

## ABSOLUTE MAXIMUM RATINGS

$T_A = 25^\circ\text{C}$ , unless otherwise noted. Transient currents of up to 60 mA do not cause SCR latch-up.

Table 5.

Parameter	Rating
$V_{DD}$ to AGND	-0.3 V to +17 V
$V_{SS}$ to AGND	-17 V to +0.3 V
$DV_{CC}$ to DGND	-0.3 V to +7 V
Digital Inputs to DGND	-0.3 V to $DV_{CC} + 0.3$ V
Digital Outputs to DGND	-0.3 V to $DV_{CC} + 0.3$ V
VREF0, VREF1 to AGND	-0.3 V to +5.5 V
VOUT0 through VOUT39 to AGND	$V_{SS} - 0.3$ V to $V_{DD} + 0.3$ V
SIGGND0 through SIGGND4 to AGND	-1 V to +1 V
AGND to DGND	-0.3 V to +0.3 V
Operating Temperature Range ( $T_A$ )	
Industrial (B Version)	-40°C to +85°C
Storage	-65°C to +150°C
Operating Junction Temperature ( $T_J$ max)	130°C
$\theta_{JA}$ Thermal Impedance	
64-Lead LFCSP	25°C/W
64-Lead LQFP	45.5°C/W
Reflow Soldering	
Peak Temperature	230°C
Time at Peak Temperature	10 sec to 40 sec

Stresses above those listed under Absolute Maximum Ratings may cause permanent damage to the device. This is a stress rating only; functional operation of the device at these or any other conditions above those indicated in the operational section of this specification is not implied. Exposure to absolute maximum rating conditions for extended periods may affect device reliability.

### ESD CAUTION



#### ESD (electrostatic discharge) sensitive device.

Charged devices and circuit boards can discharge without detection. Although this product features patented or proprietary protection circuitry, damage may occur on devices subjected to high energy ESD. Therefore, proper ESD precautions should be taken to avoid performance degradation or loss of functionality.

## PIN CONFIGURATIONS AND FUNCTION DESCRIPTIONS

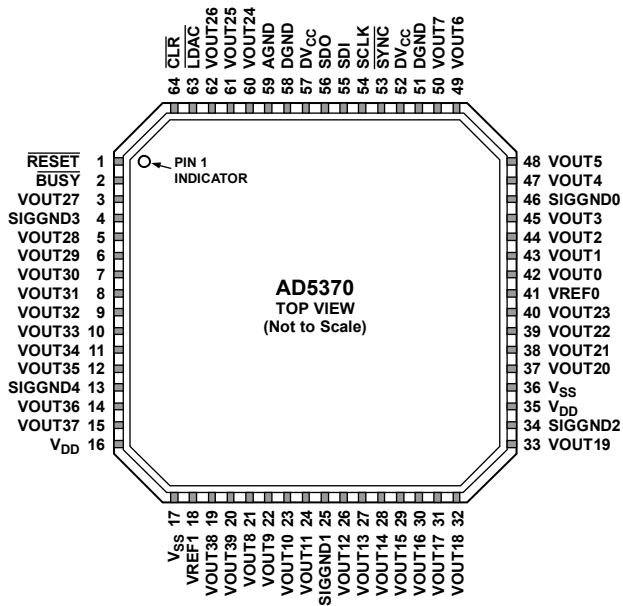

05813-007

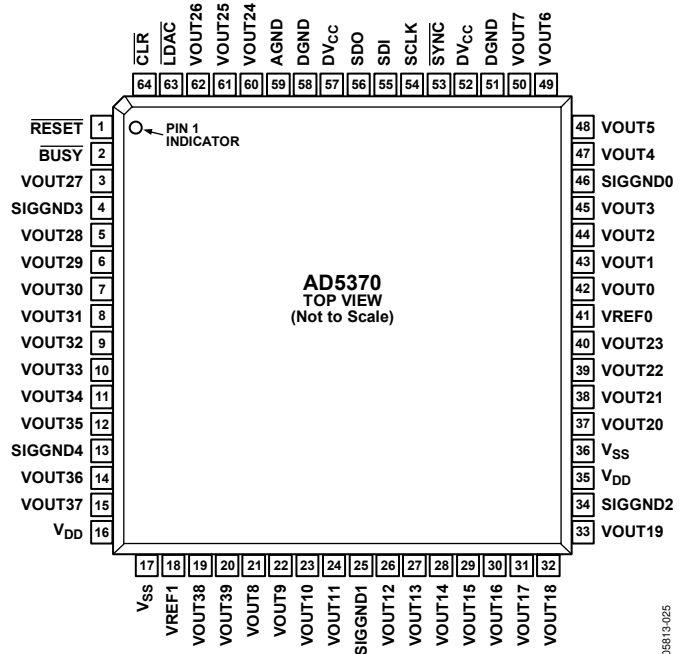

05813-025

Figure 6. 64-Lead LFCSP Pin Configuration

Figure 7. 64-Lead LQFP Pin Configuration

Table 6. Pin Function Descriptions

Pin No.	Mnemonic	Description
1	RESET	Digital Reset Input.
2	BUSY	BUSY Input/Output (Active Low). BUSY is open-drain when an output. See the BUSY and LDAC Functions section for more information.
3, 5 to 12, 14, 15, 19 to 24, 26 to 33, 37 to 40, 42 to 45, 47 to 50, 60 to 62	VOUT0 to VOUT39	DAC Outputs. Buffered analog outputs for each of the 40 DAC channels. Each analog output is capable of driving an output load of 10 kΩ to ground. Typical output impedance of these amplifiers is 0.5 Ω.
46	SIGGND0	Reference Ground for DAC 0 to DAC 7. VOUT0 to VOUT7 are referenced to this voltage.
25	SIGGND1	Reference Ground for DAC 8 to DAC 15. VOUT8 to VOUT15 are referenced to this voltage.
34	SIGGND2	Reference Ground for DAC 16 to DAC 23. VOUT16 to VOUT23 are referenced to this voltage.
4	SIGGND3	Reference Ground for DAC 24 and DAC 31. VOUT24 to VOUT31 are referenced to this voltage.
13	SIGGND4	Reference Ground for DAC 32 to DAC 39. VOUT32 to VOUT39 are referenced to this voltage.
41	VREF0	Reference Input for DAC 0 to DAC 7. This reference voltage is referred to AGND.
18	VREF1	Reference Input for DAC 8 to DAC 39. This reference voltage is referred to AGND.

Pin No.	Mnemonic	Description
16, 35	V <sub>DD</sub>	Positive Analog Power Supply; +9 V to +16.5 V for specified performance. These pins should be decoupled with 0.1 $\mu$ F ceramic capacitors and 10 $\mu$ F capacitors.
17, 36	V <sub>SS</sub>	Negative Analog Power Supply; –16.5 V to –8 V for specified performance. These pins should be decoupled with 0.1 $\mu$ F ceramic capacitors and 10 $\mu$ F capacitors.
51, 58	DGND	Ground for All Digital Circuitry. Both DGND pins should be connected to the DGND plane.
52, 57	DV <sub>CC</sub>	Logic Power Supply; 2.5 V to 5.5 V. These pins should be decoupled with 0.1 $\mu$ F ceramic capacitors and 10 $\mu$ F capacitors.
53	$\overline{\text{SYNC}}$	Active Low Input. This is the frame synchronization signal for the serial interface. See the Timing Characteristics section for more details.
54	SCLK	Serial Clock Input. Data is clocked into the shift register on the falling edge of SCLK. This pin operates at clock speeds up to 50 MHz. See the Timing Characteristics section for more details.
55	SDI	Serial Data Input. Data must be valid on the falling edge of SCLK. See the Timing Characteristics section for more details.
56	SDO	Serial Data Output for SPI Interface. CMOS output. SDO can be used for readback. Data is clocked out on SDO on the rising edge of SCLK and is valid on the falling edge of SCLK.
59	AGND	Ground for All Analog Circuitry. The AGND pin should be connected to the AGND plane.
63	$\overline{\text{LDAC}}$	Load DAC Logic Input (Active Low).
64	$\overline{\text{CLR}}$	Asynchronous Clear Input (Level Sensitive, Active Low). See the Clear Function section for more information.
	Exposed Paddle	The lead-free chip scale package (LFCSP) has an exposed paddle on the underside. The paddle should be connected to V <sub>SS</sub> .

TYPICAL PERFORMANCE CHARACTERISTICS

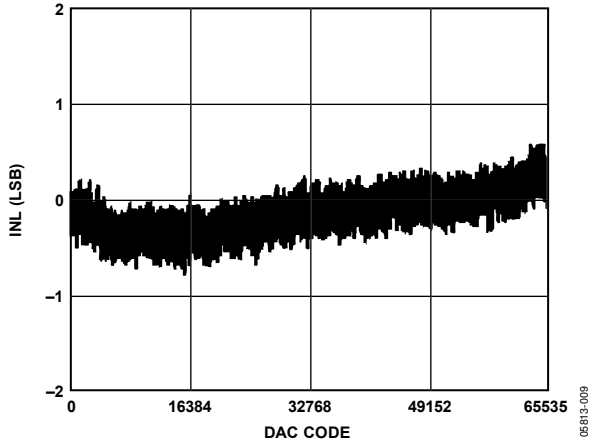

Figure 8. Typical INL Plot

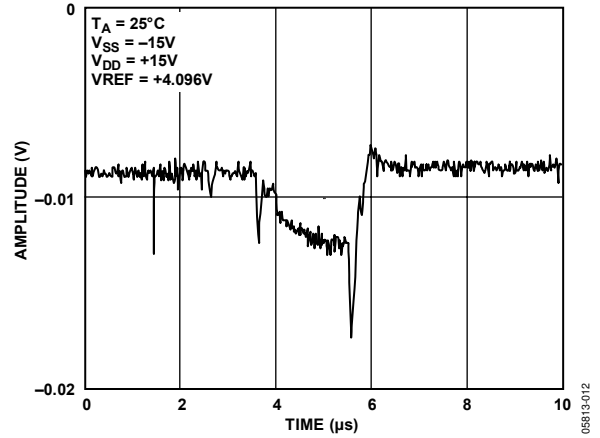

Figure 11. Analog Crosstalk Due to  $\overline{LDAC}$

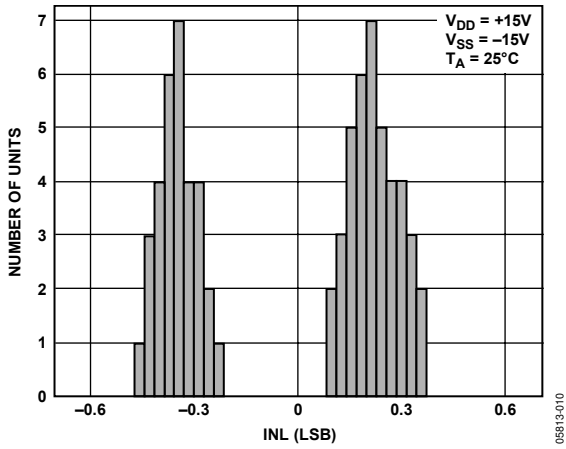

Figure 9. Typical INL Distribution

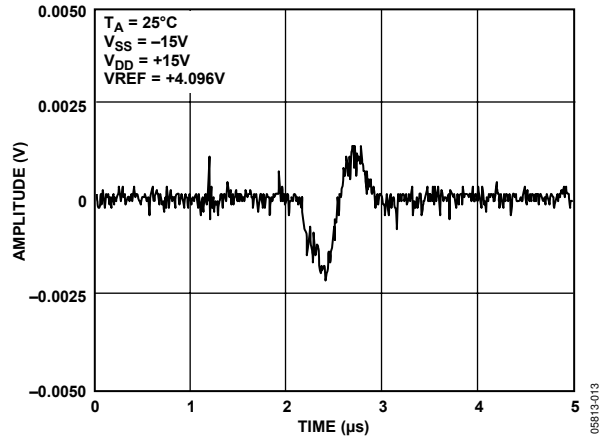

Figure 12. Digital Crosstalk

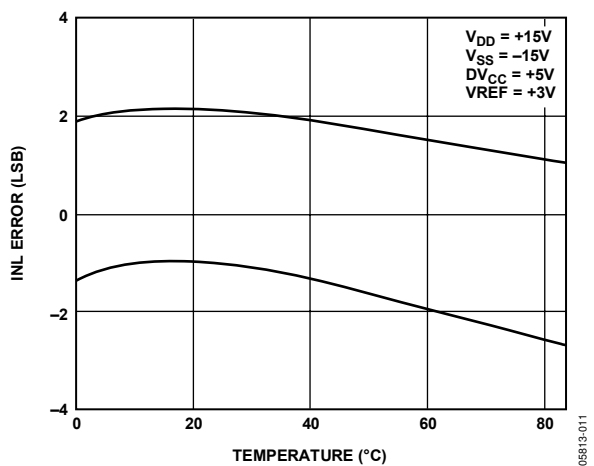

Figure 10. Typical INL Error vs. Temperature

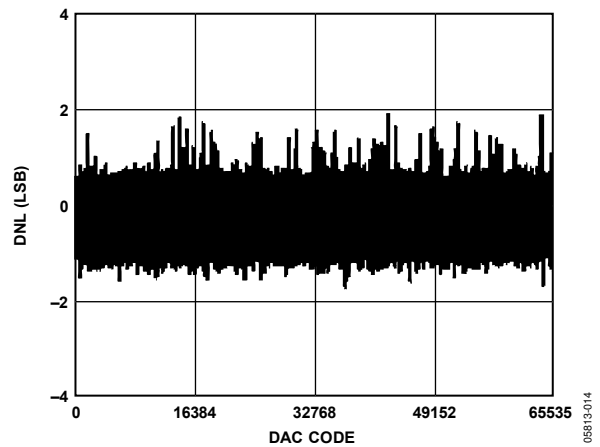

Figure 13. Typical DNL Plot



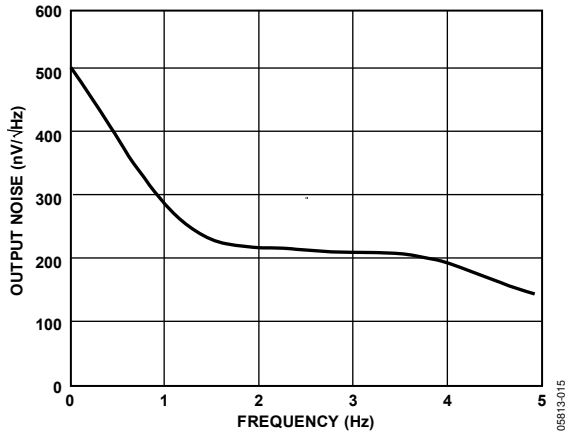

Figure 14. Noise Spectral Density

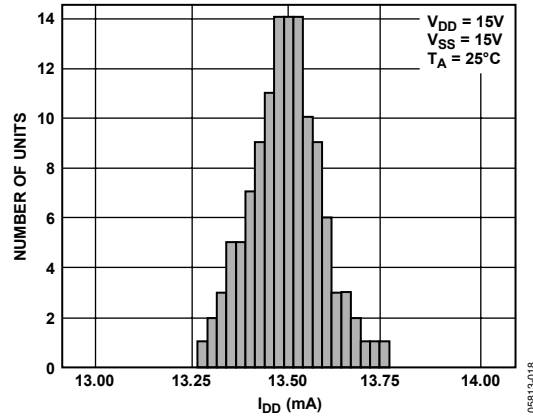

Figure 17. Typical  $I_{DD}$  Distribution

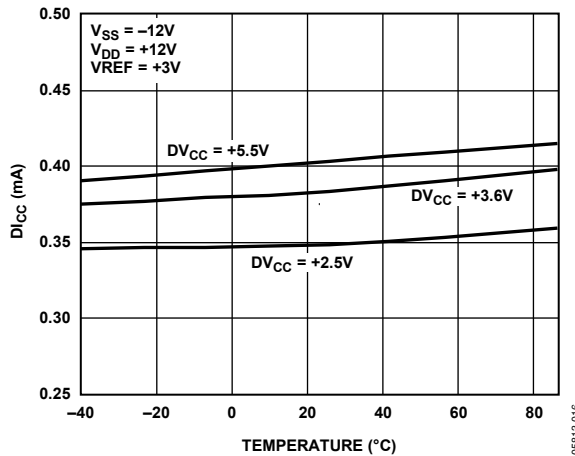

Figure 15.  $D_{I_{CC}}$  vs. Temperature

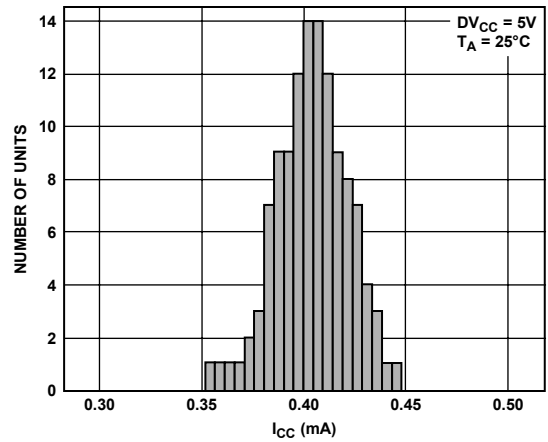

Figure 18. Typical  $D_{I_{CC}}$  Distribution

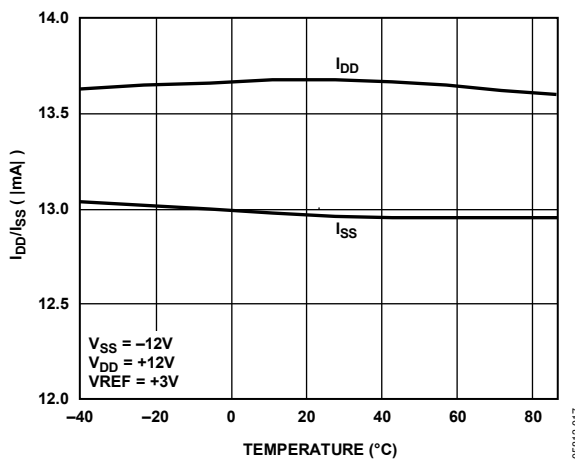

Figure 16.  $I_{DD}/I_{SS}$  vs. Temperature

## TERMINOLOGY

### Integral Nonlinearity (INL)

Integral nonlinearity, or endpoint linearity, is a measure of the maximum deviation from a straight line passing through the endpoints of the DAC transfer function. It is measured after adjusting for zero-scale error and full-scale error and is expressed in least significant bits (LSB).

### Differential Nonlinearity (DNL)

Differential nonlinearity is the difference between the measured change and the ideal 1 LSB change between any two adjacent codes. A specified differential nonlinearity of 1 LSB maximum ensures monotonicity.

### Zero-Scale Error

Zero-scale error is the error in the DAC output voltage when all 0s are loaded into the DAC register.

Zero-scale error is a measure of the difference between V<sub>OUT</sub> (actual) and V<sub>OUT</sub> (ideal), expressed in millivolts, when the channel is at its minimum value. Zero-scale error is mainly due to offsets in the output amplifier.

### Full-Scale Error

Full-scale error is the error in DAC output voltage when all 1s are loaded into the DAC register. Full-scale error is a measure of the difference between V<sub>OUT</sub> (actual) and V<sub>OUT</sub> (ideal), expressed in millivolts, when the channel is at its maximum value. It does not include zero-scale error.

### Gain Error

Gain error is the difference between full-scale error and zero-scale error. It is expressed in millivolts.

$$\text{Gain Error} = \text{Full-Scale Error} - \text{Zero-Scale Error}$$

### V<sub>OUT</sub> Temperature Coefficient

This includes output error contributions from linearity, offset, and gain drift.

### DC Output Impedance

DC output impedance is the effective output source resistance. It is dominated by package lead resistance.

### DC Crosstalk

The DAC outputs are buffered by op amps that share common V<sub>DD</sub> and V<sub>SS</sub> power supplies. If the dc load current changes in one channel (due to an update), this can result in a further dc change in one or more channel outputs. This effect is more

significant at high load currents and reduces as the load currents are reduced. With high impedance loads, the effect is virtually immeasurable. Multiple V<sub>DD</sub> and V<sub>SS</sub> terminals are provided to minimize dc crosstalk.

### Output Voltage Settling Time

The amount of time it takes for the output of a DAC to settle to a specified level for a full-scale input change.

### Digital-to-Analog Glitch Energy

The amount of energy injected into the analog output at the major code transition. It is specified as the area of the glitch in nV-s. It is measured by toggling the DAC register data between 0x1FFF and 0x2000.

### Channel-to-Channel Isolation

Channel-to-channel isolation refers to the proportion of input signal from the reference input of one DAC that appears at the output of another DAC operating from another reference. It is expressed in decibels and measured at midscale.

### DAC-to-DAC Crosstalk

DAC-to-DAC crosstalk is the glitch impulse that appears at the output of one converter due to both the digital change and subsequent analog output change at another converter. It is specified in nV-s.

### Digital Crosstalk

The glitch impulse transferred to the output of one converter due to a change in the DAC register code of another converter is defined as the digital crosstalk and is specified in nV-s.

### Digital Feedthrough

When the device is not selected, high frequency logic activity on the digital inputs of the device can be capacitively coupled both across and through the device to appear as noise on the V<sub>OUTx</sub> pins. It can also be coupled along the supply and ground lines. This noise is digital feedthrough.

### Output Noise Spectral Density

Output noise spectral density is a measure of internally generated random noise. Random noise is characterized as a spectral density (voltage per  $\sqrt{\text{Hz}}$ ). It is measured by loading all DACs to midscale and measuring noise at the output. It is measured in nV/ $\sqrt{\text{Hz}}$ .

## THEORY OF OPERATION

### DAC ARCHITECTURE

The AD5370 contains 40 DAC channels and 40 output amplifiers in a single package. The architecture of a single DAC channel consists of a 16-bit resistor-string DAC followed by an output buffer amplifier. The resistor-string section is simply a string of resistors, of equal value, from VREF to AGND. This type of architecture guarantees DAC monotonicity. The 16-bit binary digital code loaded to the DAC register determines at which node on the string the voltage is tapped off before being fed into the output amplifier. The output amplifier multiplies the DAC output voltage by 4. The nominal output span is 12 V with a 3 V reference and 20 V with a 5 V reference.

### CHANNEL GROUPS

The 40 DAC channels of the AD5370 are arranged into five groups of eight channels. The eight DACs of Group 0 derive their reference voltage from VREF0. Group 1 to Group 4 derive their reference voltage from VREF1. Each group has its own signal ground pin.

Table 7. AD5370 Registers

Register Name	Word Length (Bits)	Default Value	Description
X1A	16	0x1555	Input Data Register A. One for each DAC channel.
X1B	16	0x1555	Input Data Register B. One for each DAC channel.
M	16	0x3FFF	Gain trim register. One for each DAC channel.
C	16	0x2000	Offset trim register. One for each DAC channel.
X2A	16	Not user accessible	Output Data Register A. One for each DAC channel. These registers store the final calibrated DAC data after gain and offset trimming. They are not readable or directly writable.
X2B	16	Not user accessible	Output Data Register B. One for each DAC channel. These registers store the final calibrated DAC data after gain and offset trimming. They are not readable or directly writable.
DAC		Not user accessible	Data registers from which the DAC channels take their final input data. The DAC registers are updated from the X2A or X2B register. They are not readable or directly writable.
OFS0	14	0x1555	Offset DAC 0 data register. Sets the offset for Group 0.
OFS1	14	0x1555	Offset DAC 1 data register. Sets the offset for Group 1 to Group 4.
Control	3	0x00	Bit 2 = $\bar{A}/B$ . 0 = global selection of X1A input data registers. 1 = X1B registers. Bit 1 = enable temperature shutdown. 0 = disable temperature shutdown. 1 = enable. Bit 0 = soft power-down. 0 = soft power-up. 1 = soft power-down.
$\bar{A}/B$ Select 0	8	0x00	Each bit in this register determines if a DAC channel in Group 0 takes its data from Register X2A or X2B. 0 = X2A. 1 = X2B.
$\bar{A}/B$ Select 1	8	0x00	Each bit in this register determines if a DAC channel in Group 1 takes its data from Register X2A or X2B. 0 = X2A. 1 = X2B.
$\bar{A}/B$ Select 2	8	0x00	Each bit in this register determines if a DAC channel in Group 2 takes its data from Register X2A or X2B. 0 = X2A. 1 = X2B.
$\bar{A}/B$ Select 3	8	0x00	Each bit in this register determines if a DAC channel in Group 3 takes its data from Register X2A or X2B. 0 = X2A. 1 = X2B.
$\bar{A}/B$ Select 4	8	0x00	Each bit in this register determines if a DAC channel in Group 4 takes its data from Register X2A or X2B. 0 = X2A. 1 = X2B.

## A/B REGISTERS AND GAIN/OFFSET ADJUSTMENT

Each DAC channel has seven data registers. The actual DAC data-word can be written to either the X1A or X1B input register, depending on the setting of the  $\overline{A/B}$  bit in the Control register. If the  $\overline{A/B}$  bit is 0, data is written to the X1A register. If the  $\overline{A/B}$  bit is 1, data is written to the X1B register. Note that this single bit is a global control and affects every DAC channel in the device. It is not possible to set up the device on a per-channel basis so that some writes are to X1A registers and some writes are to X1B registers.

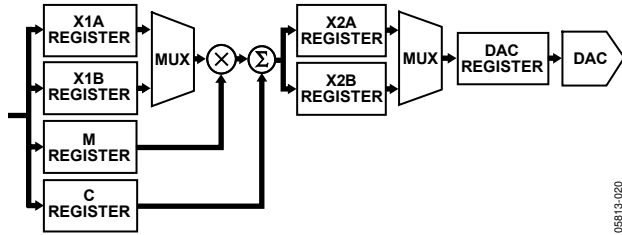

Figure 19. Data Registers Associated with Each DAC Channel

Each DAC channel also has a gain (M) register and an offset (C) register, which allow trimming out of the gain and offset errors of the entire signal chain. Data from the X1A register is operated on by a digital multiplier and an adder controlled by the contents of the M and C registers. The calibrated DAC data is then stored in the X2A register. Similarly, data from the X1B register is operated on by the multiplier and adder and stored in the X2B register.

Although Figure 19 indicates a multiplier and an adder for each channel, there is only one multiplier and one adder in the device, and they are shared among all channels. This has implications for the update speed when several channels are updated at once, as described in the Register Update Rates section.

Each time data is written to the X1A register, or to the M or C register with the  $\overline{A/B}$  control bit set to 0, the X2A data is recalculated and the X2A register is automatically updated. Similarly, X2B is updated each time data is written to X1B or to M or C with  $\overline{A/B}$  set to 1. The X2A and X2B registers are not readable or directly writable by the user.

Data output from the X2A and X2B registers is routed to the final DAC register by a multiplexer. Whether each individual DAC takes its data from the X2A or X2B register is controlled by an 8-bit  $\overline{A/B}$  select register associated with each group of eight DACs. If a bit in this register is 0, the DAC takes its data from the X2A register; if 1, the DAC takes its data from the X2B register (Bit 0 through Bit 7 control DAC0 to DAC7).

Note that, because there are 40 bits in five registers, it is possible to set up, on a per-channel basis, whether each DAC takes its data from the X2A or X2B register. A global command is also provided, which sets all bits in the  $\overline{A/B}$  select registers to 0 or to 1.

## LOAD DAC

All DAC channels in the AD5370 can be updated simultaneously by taking  $\overline{LDAC}$  low when each DAC register is updated from either its X2A or X2B register, depending on the setting of the  $\overline{A/B}$  select registers. The DAC register is not readable or directly writable by the user.

## OFFSET DAC CHANNELS

In addition to the gain and offset trim for each DAC channel, there are two 14-bit offset DAC channels, one for Group 0 and one for Group 1 to Group 4. These allow the output range of all DAC channels connected to them to be offset within a defined range. Thus, subject to the limitations of headroom, it is possible to set the output range of Group 0 or Group 1 to Group 4 to be unipolar positive, unipolar negative, or bipolar, either symmetrical or asymmetrical about 0 V. The DAC channels in the AD5370 are factory trimmed with the offset DAC channels set at their default values. This results in optimum offset and gain performance for the default output range and span.

When the output range is adjusted by changing the value of the offset DAC channel, an extra offset is introduced due to the gain error of the offset DAC channel. The amount of offset is dependent on the magnitude of the reference and how much the offset DAC channel deviates from its default value. This offset is quoted in the Specifications section.

The worst-case offset occurs when the offset DAC channel is at positive or negative full scale. This value can be added to the offset present in the main DAC channel to give an indication of the overall offset for that channel. In most cases, the offset can be removed by programming the channel's C register with an appropriate value. The extra offset caused by the offset DAC only needs to be taken into account when an offset DAC channel is changed from its default value.

Figure 20 shows the allowable code range that can be loaded to the offset DAC channel; this is dependent on the reference value used. Thus, for a 5 V reference, the offset DAC channel should not be programmed with a value greater than 8192 (0x2000).

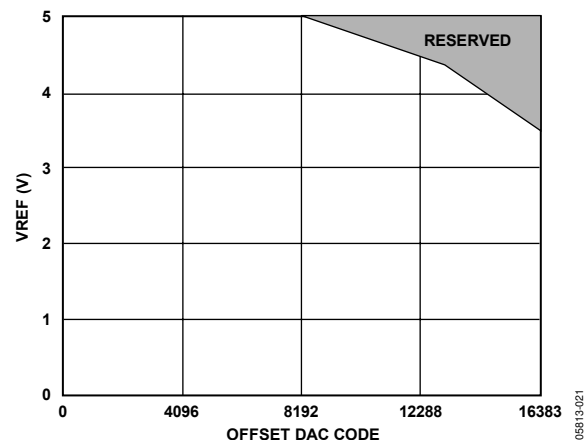

Figure 20. Offset DAC Code Range

## OUTPUT AMPLIFIER

The output amplifiers can swing to 1.4 V below the positive supply and 1.4 V above the negative supply, which limits how much the output can be offset for a given reference voltage. For example, it is not possible to have a unipolar output range of 20 V because the maximum supply voltage is  $\pm 16.5$  V.

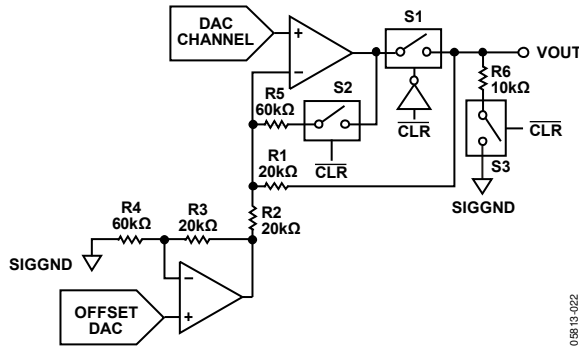

Figure 21. Output Amplifier and Offset DAC

Figure 21 shows details of a DAC output amplifier and its connections to its corresponding offset DAC. On power-up, S1 is open, disconnecting the amplifier from the output. S3 is closed; thus, the output is pulled to the corresponding SIGGND (R1 and R2 are much greater than R6). S2 is also closed to prevent the output amplifier being open-loop. If  $\overline{\text{CLR}}$  is low at power-up, the output remains in this condition until  $\overline{\text{CLR}}$  is taken high. The DAC registers can be programmed, and the outputs assume the programmed values when  $\overline{\text{CLR}}$  is taken high. Even if  $\overline{\text{CLR}}$  is high at power-up, the output remains in the previously described condition until  $V_{DD} > 6$  V and  $V_{SS} < -4$  V and the initialization sequence has finished. The outputs then go to their power-on default values.

## TRANSFER FUNCTION

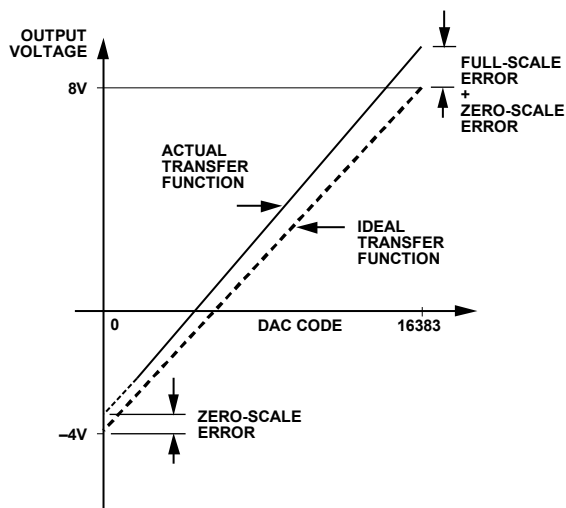

Figure 22. DAC Transfer Function

The output voltage of a DAC in the AD5370 is dependent on the value in the input register, the value of the M and C registers, and the value in the offset DAC. The transfer functions for the AD5370 are shown in the following section.

The input code is the value in the X1A or X1B register that is applied to DAC (X1A, X1B default code = 5461), as follows:

$$DAC\_CODE = \frac{INPUT\_CODE \times (M + 1)}{2^{16}} + C - 2^{15}$$

DAC output voltage is calculated as follows:

$$V_{OUT} = 4 \times V_{REF} \times \frac{DAC\_CODE - (4 \times OFFSET\_CODE)}{2^{16}} + V_{SIGGND}$$

where:

$DAC\_CODE$  should be within the range of 0 to 65,535.

For 12 V span,  $V_{REF} = 3.0$  V.

For 20 V span,  $V_{REF} = 5.0$  V.

$M$  = code in gain register – default code =  $2^{16} - 1$ .

$C$  = code in offset register – default code =  $2^{15}$ .

$OFFSET\_CODE$  is the code loaded to the offset DAC. It is multiplied by 4 in the transfer function because the offset DAC is a 14-bit device. On power-up, the default code loaded to the offset DAC is 5461 (0x1555). With a 3 V reference, this gives a span of  $-4$  V to  $+8$  V.

## REFERENCE SELECTION

The AD5370 has two reference input pins. The voltage applied to the reference pins determines the output voltage span on  $V_{OUT0}$  to  $V_{OUT39}$ .  $V_{REF0}$  determines the voltage span for  $V_{OUT0}$  to  $V_{OUT7}$  (Group 0) and  $V_{REF1}$  determines the voltage span for  $V_{OUT8}$  to  $V_{OUT39}$  (Group 2 to Group 4). The reference voltage applied to each  $V_{REF}$  pin can be different, if required, allowing each group to have a different voltage span. The output voltage range and span can be adjusted further by programming the offset and gain registers for each channel and by programming the offset DAC channels. If the offset and gain features are not used (that is, the M and C registers are left at their default values), the required reference levels can be calculated as follows:

$$V_{REF} = (V_{OUT\_MAX} - V_{OUT\_MIN})/4$$

If the offset and gain features of the AD5370 are used, the required output range is slightly different. The chosen output range should take into account the system offset and gain errors that need to be trimmed out. Therefore, the chosen output range should be larger than the actual required range.

The required reference levels can be calculated as follows:

1. Identify the nominal output range on  $V_{OUT}$ .
2. Identify the maximum offset span and the maximum gain required on the full output signal range.
3. Calculate the new maximum output range on  $V_{OUT}$ , including the expected maximum offset and gain errors.
4. Choose the new required  $V_{OUT\_MAX}$  and  $V_{OUT\_MIN}$ , keeping the  $V_{OUT}$  limits centered on the nominal values. Note that  $V_{DD}$  and  $V_{SS}$  must provide sufficient headroom.
5. Calculate the value of  $V_{REF}$  as follows:

$$V_{REF} = (V_{OUT\_MAX} - V_{OUT\_MIN})/4$$

## Reference Selection Example

If

- Nominal Output Range = 12 V (–4 V to +8 V)
- Zero-Scale Error =  $\pm 70$  mV
- Gain Error =  $\pm 3\%$
- SIGGND = AGND = 0 V

Then

- Gain Error =  $\pm 3\%$   
=> Maximum Positive Gain Error = +3%  
=> Output Range Including Gain Error =  $12 + 0.03(12) = 12.36$  V
- Offset Error =  $\pm 70$  mV  
=> Maximum Offset Error Span =  $2(70 \text{ mV}) = 0.14$  V  
=> Output Range Including Gain Error and Offset Error =  $12.36 \text{ V} + 0.14 \text{ V} = 12.5$  V
- VREF Calculation  
Actual Output Range = 12.5 V, that is, –4.25 V to +8.25 V;  
 $V_{REF} = (8.25 \text{ V} + 4.25 \text{ V})/4 = 3.125$  V

If the equation yields an inconvenient reference level, the user can adopt one of the following approaches:

- Use a resistor divider to divide down a convenient, higher reference level to the required level.
- Select a convenient reference level above VREF, and modify the gain and offset registers to downsize the reference digitally. In this way, the user can use almost any convenient reference level but may reduce the performance by overcompaction of the transfer function.
- Use a combination of these two approaches.

## CALIBRATION

The user can perform a system calibration on the AD5370 to reduce gain and offset errors to below 1 LSB. This is achieved by calculating new values for the M and C registers and reprogramming them.

### Reducing Zero-Scale Error

Zero-scale error can be reduced as follows:

1. Set the output to the lowest possible value.
2. Measure the actual output voltage and compare it with the required value. This gives the zero-scale error.
3. Calculate the number of LSBs equivalent to the error and add this from the default value of the C register. Note that only negative zero-scale error can be reduced.

### Reducing Full-scale Error

Full-scale error can be reduced as follows:

1. Measure the zero-scale error.
2. Set the output to the highest possible value.
3. Measure the actual output voltage and compare it with the required value. Add this error to the zero-scale error. This is the span error, which includes the full-scale error.
4. Calculate the number of LSBs equivalent to the full-scale error and subtract it from the default value of the M register. Note that only positive full-scale error can be reduced.
5. The M and C registers should not be programmed until both zero-scale and full-scale errors have been calculated.

### AD5370 Calibration Example

This example assumes that a –4 V to +8 V output is required. The DAC output is set to –4 V but measured at –4.03 V. This gives a zero-scale error of –30 mV.

1.  $1 \text{ LSB} = 12 \text{ V}/65,536 = 183.11 \mu\text{V}$
2.  $30 \text{ mV} = 164 \text{ LSB}$

The full-scale error can now be calculated. The output is set to +8 V and a value of +8.02 V is measured. The full-scale error is  $+20 \text{ mV} - (-30 \text{ mV}) = +50 \text{ mV}$ .

$$50 \text{ mV} = 273 \text{ LSBs}$$

The errors can now be removed.

1. 164 LSB should be added to the default C register value, that is  $(32,768 + 164) = 32,932$ .
2. 273 LSB should be subtracted from the default M register value; that is,  $(65,535 - 273) = 65,262$ .
3. 65,262 should be programmed to the M register and 32,932 should be programmed to the C register.

### ADDITIONAL CALIBRATION

The techniques described in the previous section are usually enough to reduce the zero-scale and full-scale errors in most applications. However, there are limitations whereby the errors may not be sufficiently removed. For example, the offset (C) register can only be used to reduce the offset caused by the negative zero-scale error. A positive offset cannot be reduced. Likewise, if the maximum voltage is below the ideal value, that is, a negative full-scale error, the gain (M) register cannot be used to increase the gain to compensate for the error.

These limitations can be overcome by increasing the reference value. With a 3 V reference, a 12 V span is achieved. The ideal voltage range for the AD5370 is –4 V to +8 V. Using a 3.1 V reference increases the range to –4.133 V to +8.2667 V. Clearly, in this case, the offset and gain errors are insignificant, and the M and C registers can be used to raise the negative voltage to –4 V and then reduce the maximum voltage to +8 V to give the most accurate values possible.



## RESET FUNCTION

The reset function is initiated by the  $\overline{\text{RESET}}$  pin. On the rising edge of  $\overline{\text{RESET}}$ , the AD5370 state machine initiates a reset sequence to reset the X, M, and C registers to their default values. This sequence typically takes 300  $\mu\text{s}$ , and the user should not write to the part during this time. On power-up, it is recommended that the user bring  $\overline{\text{RESET}}$  high as soon as possible to properly initialize the registers.

When the reset sequence is complete (and provided that  $\overline{\text{CLR}}$  is high), the DAC output is at a potential specified by the default register settings, which are equivalent to SIGGNDx. The DAC outputs remain at SIGGNDx until the X, M, or C register is updated and  $\overline{\text{LDAC}}$  is taken low. The AD5370 can be returned to the default state by pulsing  $\overline{\text{RESET}}$  low for at least 30 ns. Note that, because the reset function is triggered on the rising edge, bringing  $\overline{\text{RESET}}$  low has no effect on the operation of the AD5370.

## CLEAR FUNCTION

$\overline{\text{CLR}}$  is an active low input that should be high for normal operation. The  $\overline{\text{CLR}}$  pin has an internal 500 k $\Omega$  pull-down resistor. When  $\overline{\text{CLR}}$  is low, the input to each of the DAC output buffer stages, VOUT0 to VOUT39, is switched to the externally set potential on the relevant SIGGND pin. While  $\overline{\text{CLR}}$  is low, all  $\overline{\text{LDAC}}$  pulses are ignored. When  $\overline{\text{CLR}}$  is taken high again, the DAC outputs remain cleared until  $\overline{\text{LDAC}}$  is taken low. The contents of the input registers and DAC registers are not affected by taking  $\overline{\text{CLR}}$  low. To prevent glitches from appearing on the outputs,  $\overline{\text{CLR}}$  should be brought low by writing to the offset DAC whenever the output span is adjusted.

## BUSY AND LDAC FUNCTIONS

The value of an X2 (A or B) register is calculated each time the user writes new data to the corresponding X1, C, or M register. During the calculation of X2, the  $\overline{\text{BUSY}}$  output goes low. While  $\overline{\text{BUSY}}$  is low, the user can continue writing new data to the X1, M, or C register (see the Register Update Rates section for more details), but no DAC output updates can take place.

The  $\overline{\text{BUSY}}$  pin is bidirectional and has a 50 k $\Omega$  internal pull-up resistor. In cases where multiple AD5370 devices are used in one system, the  $\overline{\text{BUSY}}$  pins can be tied together. This is useful when it is required that no DAC channel in any device be updated until all other DAC channels are ready to be updated. When each device finishes updating the X2 (A or B) register, it releases the  $\overline{\text{BUSY}}$  pin. If another device has not finished updating its X2 register, it holds  $\overline{\text{BUSY}}$  low, thus delaying the effect of  $\overline{\text{LDAC}}$  going low.

The DAC outputs are updated by taking the  $\overline{\text{LDAC}}$  input low. If  $\overline{\text{LDAC}}$  goes low while  $\overline{\text{BUSY}}$  is active, the  $\overline{\text{LDAC}}$  event is stored and the DAC outputs update immediately after  $\overline{\text{BUSY}}$  goes high. A user can also hold the  $\overline{\text{LDAC}}$  input permanently low. In this case, the DAC outputs update immediately after  $\overline{\text{BUSY}}$  goes

high. Whenever the  $\overline{\text{A/B}}$  select registers are written to,  $\overline{\text{BUSY}}$  also goes low, for approximately 600 ns.

The AD5370 has flexible addressing that allows writing of data to a single channel, all channels in a group, the same channel in Group 0 to Group 4 or the same channel in Group 1 to Group 4, or all channels in the device. This means that 1, 4, 5, 8, or 40 DAC register values may need to be calculated and updated. Because there is only one multiplier shared among 40 channels, this task must be done sequentially so that the length of the  $\overline{\text{BUSY}}$  pulse varies according to the number of channels being updated.

**Table 8.  $\overline{\text{BUSY}}$  Pulse Widths**

Action	$\overline{\text{BUSY}}$ Pulse Width <sup>1</sup> ( $\mu\text{s}$ max)
Loading X1A, X1B, C, or M to 1 channel <sup>2</sup>	1.5
Loading X1A, X1B, C, or M to 4 channels	3.3
Loading X1A, X1B, C, or M to 5 channels	3.9
Loading X1A, X1B, C, or M to 8 channels	5.7
Loading X1A, X1B, C, or M to 40 channels	24.9

<sup>1</sup>  $\overline{\text{BUSY}}$  Pulse Width = ((Number of Channels + 1)  $\times$  600 ns) + 300 ns.

<sup>2</sup> A single channel update is typically 1  $\mu\text{s}$ .

The AD5370 contains an extra feature whereby a DAC register is not updated unless its X2A or X2B register has been written to since the last time  $\overline{\text{LDAC}}$  was brought low. Normally, when  $\overline{\text{LDAC}}$  is brought low, the DAC registers are filled with the contents of the X2A or X2B register, depending on the setting of the  $\overline{\text{A/B}}$  select registers. However, the AD5370 updates the DAC register only if the X2 data has changed, thereby removing unnecessary digital crosstalk.

## POWER-DOWN MODE

The AD5370 can be powered down by setting Bit 0 in the control register to 1. This turns off the DAC channels, thus reducing the current consumption. The DAC outputs are connected to their respective SIGGND potentials. The power-down mode does not change the contents of the registers, and the DAC channels return to their previous voltage when the power-down bit is cleared to 0.

## THERMAL SHUTDOWN FUNCTION

The AD5370 can be programmed to power down the DACs if the temperature on the die exceeds 130°C. Setting Bit 1 in the control register to 1 (see the Special Function Mode section) enables this function. If the die temperature exceeds 130°C, the AD5370 enters a temperature power-down mode, which is equivalent to setting the power-down bit in the control register. To indicate that the AD5370 has entered temperature shutdown mode, Bit 4 of the control register is set to 1. The AD5370 remains in temperature shutdown mode, even if the die temperature falls, until Bit 1 in the control register is cleared to 0.

## TOGGLE MODE

The AD5370 has two X2 registers per channel, X2A and X2B, that can be used to switch the DAC output between two levels with ease. This approach greatly reduces the overhead required by a microprocessor that would otherwise have to write to each channel individually. When the user writes to the X1A, X2A, M, or C register, the calculation engine takes a certain amount of time to calculate the appropriate X2A or X2B value. If the application only requires that the DAC output switch between two levels, as is the case with a data generator, any method that reduces the amount of calculation time necessary is advantageous.

For the data generator example, the user need only set the high and low levels for each channel once by writing to the X1A and X1B registers. The values of X2A and X2B are calculated and stored in their respective registers. The calculation delay therefore happens only during the setup phase, that is, when programming the initial values. To toggle a DAC output between the two levels, it is only required to write to the relevant  $\bar{A}/B$  select register to set the MUX2 register bit. Furthermore, because there are eight MUX2 control bits per register, it is possible to update eight channels with a single write. Table 15 shows the bits that correspond to each DAC output.

## SERIAL INTERFACE

The AD5370 contains a high speed SPI-compatible serial interface operating at clock frequencies up to 50 MHz (20 MHz for read operations). To minimize both the power consumption of the device and on-chip digital noise, the interface powers up fully only when the device is being written to, that is, on the falling edge of  $\overline{\text{SYNC}}$ . The serial interface is 2.5 V LVTTTL-compatible when operating from a 2.5 V to 3.6 V  $DV_{CC}$  supply. It is controlled by four pins:  $\overline{\text{SYNC}}$  (frame synchronization input), SDI (serial data input pin), SCLK (clocks data in and out of the device), and SDO (serial data output pin for data readback).

### SPI WRITE MODE

The AD5370 allows writing of data via the serial interface to every register directly accessible to the serial interface, which is all registers except the X2A and X2B registers and the DAC registers. The X2A and X2B registers are updated when the user writes to the X1A, X1B, M, or C register, and the DAC registers are updated by LDAC.

The serial word (see Table 10) is 24 bits long; 16 of these bits are data bits, six bits are address bits, and two bits are mode bits that determine what is done with the data.

The serial interface works with both a continuous and a burst (gated) serial clock. Serial data applied to SDI is clocked into the AD5370 by clock pulses applied to SCLK. The first falling edge of  $\overline{\text{SYNC}}$  starts the write cycle. At least 24 falling clock edges must be applied to SCLK to clock in 24 bits of data before  $\overline{\text{SYNC}}$  is taken high again. If  $\overline{\text{SYNC}}$  is taken high before the 24<sup>th</sup> falling clock edge, the write operation is aborted.

If a continuous clock is used,  $\overline{\text{SYNC}}$  must be taken high before the 25<sup>th</sup> falling clock edge. This inhibits the clock within the AD5370. If more than 24 falling clock edges are applied before  $\overline{\text{SYNC}}$  is taken high again, the input data becomes corrupted. If an externally gated clock of exactly 24 pulses is used,  $\overline{\text{SYNC}}$  can be taken high any time after the 24<sup>th</sup> falling clock edge.

The input register addressed is updated on the rising edge of  $\overline{\text{SYNC}}$ . For another serial transfer to take place,  $\overline{\text{SYNC}}$  must be taken low again.

### SPI READBACK MODE

The AD5370 allows data readback via the serial interface from every register directly accessible to the serial interface, which is all registers except the X2A, X2B, and DAC registers. To read back a register, it is first necessary to tell the AD5370 which register to read. This is achieved by writing a word whose

first two bits are the Special Function Code 00 to the device. The remaining bits then determine which register is to be read back.

If a readback command is written to a special function register, data from the selected register is clocked out of the SDO pin during the next SPI operation. The SDO pin is normally three-stated but becomes driven as soon as a read command is issued. The pin remains driven until the register data is clocked out. See Figure 5 for the read timing diagram. Note that, due to the timing requirements of  $t_s$  (25 ns), the maximum speed of the SPI interface during a read operation should not exceed 20 MHz.

### REGISTER UPDATE RATES

The value of the X2A or X2B register is calculated each time the user writes new data to the corresponding X1, C, or M register. The calculation is performed by a three-stage process. The first two stages take approximately 600 ns each, and the third stage takes approximately 300 ns. When the write to the X1, C, or M register is complete, the calculation process begins. If the write operation involves the update of a single DAC channel, the user is free to write to another register, provided that the write operation does not finish until the first stage calculation is complete, that is, 600 ns after completion of the first write operation. If a group of channels is being updated by a single write operation, the first stage calculation is repeated for each channel, taking 600 ns per channel. In this case, the user should not complete the next write operation until this time has elapsed.

### CHANNEL ADDRESSING AND SPECIAL MODES

If the mode bits are not 00, the data-word for D13 to D0 is written to the device. Address Bit A5 to Address Bit A0 determine which channels are written to, whereas the mode bits determine the register (X1A, X1B, C, or M) to which the data is written, as shown in Table 9. If data is to be written to the X1A or X1B register, the setting of the  $\overline{\text{A/B}}$  bit in the control register determines the register to which the data is written (that is, 0  $\rightarrow$  X1A, 1  $\rightarrow$  X1B).

Table 9. Mode Bits

M1	M0	Action
1	1	Writes to the DAC input data (X) register, depending on the control register $\overline{\text{A/B}}$ bit
1	0	Writes to the DAC offset (C) register
0	1	Writes to the DAC gain (M) register
0	0	Special function, used in combination with other bits of the data-word

Table 10. Serial Word Bit Assignment

I23	I22	I21	I20	I19	I18	I17	I16	I15	I14	I13	I12	I11	I10	I9	I8	I7	I6	I5	I4	I3	I2	I1	I0
M1	M0	A5	A4	A3	A2	A1	A0	D15	D14	D13	D12	D11	D10	D9	D8	D7	D6	D5	D4	D3	D2	D1	D0

# AD5370

Table 11 shows the groups and channels that are addressed for every combination of Address Bit A5 to Address Bit A0.

**Table 11. Group and Channel Addressing**

Address Bit A2 to Address Bit A0	Address Bit A5 to Address Bit A3							
	000	001	010	011	100	101	110	111
000	All groups, all channels	Group 0, Channel 0	Group 1, Channel 0	Group 2, Channel 0	Group 3, Channel 0	Group 4, Channel 0	Group 0, Group 1, Group 2, Group 3, Group 4; Channel 0	Group 1, Group 2, Group 3, Group 4; Channel 0
001	Group 0, all channels	Group 0, Channel 1	Group 1, Channel 1	Group 2, Channel 1	Group 3, Channel 1	Group 4, Channel 1	Group 0, Group 1, Group 2, Group 3, Group 4; Channel 1	Group 1, Group 2, Group 3, Group 4; Channel 1
010	Group 1, all channels	Group 0, Channel 2	Group 1, Channel 2	Group 2, Channel 2	Group 3, Channel 2	Group 4, Channel 2	Group 0, Group 1, Group 2, Group 3, Group 4; Channel 2	Group 1, Group 2, Group 3, Group 4; Channel 2
011	Group 2, all channels	Group 0, Channel 3	Group 1, Channel 3	Group 2, Channel 3	Group 3, Channel 3	Group 4, Channel 3	Group 0, Group 1, Group 2, Group 3, Group 4; Channel 3	Group 1, Group 2, Group 3, Group 4; Channel 3
100	Group 3, all channels	Group 0, Channel 4	Group 1, Channel 4	Group 2, Channel 4	Group 3, Channel 4	Group 4, Channel 4	Group 0, Group 1, Group 2, Group 3, Group 4; Channel 4	Group 1, Group 2, Group 3, Group 4; Channel 4
101	Group 4, all channels	Group 0, Channel 5	Group 1, Channel 5	Group 2, Channel 5	Group 3, Channel 5	Group 4, Channel 5	Group 0, Group 1, Group 2, Group 3, Group 4; Channel 5	Group 1, Group 2, Group 3, Group 4; Channel 5
110	Reserved	Group 0, Channel 6	Group 1, Channel 6	Group 2, Channel 6	Group 3, Channel 6	Group 4, Channel 6	Group 0, Group 1, Group 2, Group 3, Group 4; Channel 6	Group 1, Group 2, Group 3, Group 4; Channel 6
111	Reserved	Group 0, Channel 7	Group 1, Channel 7	Group 2, Channel 7	Group 3, Channel 7	Group 4, Channel 7	Group 0, Group 1, Group 2, Group 3, Group 4; Channel 7	Group 1, Group 2, Group 3, Group 4; Channel 7

## SPECIAL FUNCTION MODE

If the mode bits are 00, the special function mode is selected, as shown in Table 12. Bit I21 to Bit I16 of the serial data-word select the special function, and the remaining bits are data required for execution of the special function, for example, the channel address for data readback.

The codes for the special functions are shown in Table 13. Table 14 shows the addresses for data readback.

**Table 12. Special Function Mode**

I23	I22	I21	I20	I19	I18	I17	I16	I15	I14	I13	I12	I11	I10	I9	I8	I7	I6	I5	I4	I3	I2	I1	I0
0	0	S5	S4	S3	S2	S1	S0	F15	F14	F13	F12	F11	F10	F9	F8	F7	F6	F5	F4	F3	F2	F1	F0

**Table 13. Special Function Codes**

Special Function Code						Data (F15 to F0)	Action
S5	S4	S3	S2	S1	S0		
0	0	0	0	0	0	0000 0000 0000 0000	NOP.
0	0	0	0	0	1	XXXX XXXX XXXX X [F2:F0]	Write to the Control register. F4 = overtemperature indicator (read-only bit). This bit should be 0 when writing to the Control register. F3 = reserved. This bit should be 0 when writing to the Control register. F2 = 1: select register X1B for input. F2 = 0: select register X1A for input. F1 = 1: enable temperature shutdown. F1 = 0: disable temperature shutdown. F0 = 1: soft power-down. F0 = 0: soft power-up.
0	0	0	0	1	0	XX[F13:F0]	Write data in F13:F0 to OFS0 register.
0	0	0	0	1	1	XX[F13:F0]	Write data in F13:F0 to OFS1 register.
0	0	0	1	0	0	Reserved	Reserved.
0	0	0	1	0	1	See Table 14	Select register for readback.
0	0	0	1	1	0	XXXX XXXX [F7:F0]	Write data in F7:F0 to $\bar{A}/B$ Select Register 0.
0	0	0	1	1	1	XXXX XXXX [F7:F0]	Write data in F7:F0 to $\bar{A}/B$ Select Register 1.
0	0	1	0	0	0	XXXX XXXX [F7:F0]	Write data in F7:F0 to $\bar{A}/B$ Select Register 2.
0	0	1	0	0	1	XXXX XXXX [F7:F0]	Write data in F7:F0 to $\bar{A}/B$ Select Register 3.
0	0	1	0	1	0	XXXX XXXX [F7:F0]	Write data in F7:F0 to $\bar{A}/B$ Select Register 4.
0	0	1	0	1	1	XXXX XXXX [F7:F0]	Block write $\bar{A}/B$ select registers. F7:F0 = 0, write all 0s (all channels use X2A register). F7:F0 = 1, write all 1s (all channels use X2B register).
0	1	1	1	0	0	Reserved	

# AD5370

**Table 14. Address Codes for Data Readback<sup>1</sup>**

F15	F14	F13	F12	F11	F10	F9	F8	F7	Register Read
0	0	0	Bit F12 to Bit F7 select the channel to be read back from; Channel 0 = 001000 to Channel 39 = 101111						X1A register
0	0	1							X1B register
0	1	0							C register
0	1	1							M register
1	0	0	0	0	0	0	0	1	Control register
1	0	0	0	0	0	0	1	0	OFS0 data register
1	0	0	0	0	0	0	1	1	OFS1 data register
1	0	0	0	0	0	1	0	0	Reserved
1	0	0	0	0	0	1	1	0	$\bar{A}/B$ Select Register 0
1	0	0	0	0	0	1	1	1	$\bar{A}/B$ Select Register 1
1	0	0	0	0	1	0	0	0	$\bar{A}/B$ Select Register 2
1	0	0	0	0	1	0	0	1	$\bar{A}/B$ Select Register 3
1	0	0	0	0	1	0	1	0	$\bar{A}/B$ Select Register 4

<sup>1</sup> F6 to F0 are don't cares for the data readback function.

**Table 15. DAC Channels Selected by  $\bar{A}/B$  Select Registers**

$\bar{A}/B$ Select Register	Bits <sup>1</sup>							
	F7	F6	F5	F4	F3	F2	F1	F0
0	VOUT7	VOUT6	VOUT5	VOUT4	VOUT3	VOUT2	VOUT1	VOUT0
1	VOUT15	VOUT14	VOUT13	VOUT12	VOUT11	VOUT10	VOUT9	VOUT8
2	VOUT23	VOUT22	VOUT21	VOUT20	VOUT19	VOUT18	VOUT17	VOUT16
3	VOUT31	VOUT30	VOUT29	VOUT28	VOUT27	VOUT26	VOUT25	VOUT24
4	VOUT39	VOUT38	VOUT37	VOUT36	VOUT35	VOUT34	VOUT33	VOUT32

<sup>1</sup> If the bit is 0, Register A is selected. If the bit is 1, Register B is selected.