



Chipsmall Limited consists of a professional team with an average of over 10 year of expertise in the distribution of electronic components. Based in Hongkong, we have already established firm and mutual-benefit business relationships with customers from,Europe,America and south Asia,supplying obsolete and hard-to-find components to meet their specific needs.

With the principle of “Quality Parts,Customers Priority,Honest Operation,and Considerate Service”,our business mainly focus on the distribution of electronic components. Line cards we deal with include Microchip,ALPS,ROHM,Xilinx,Pulse,ON,Everlight and Freescale. Main products comprise IC,Modules,Potentiometer,IC Socket,Relay,Connector.Our parts cover such applications as commercial,industrial, and automotives areas.

We are looking forward to setting up business relationship with you and hope to provide you with the best service and solution. Let us make a better world for our industry!



## Contact us

Tel: +86-755-8981 8866 Fax: +86-755-8427 6832

Email & Skype: info@chipsmall.com Web: www.chipsmall.com

Address: A1208, Overseas Decoration Building, #122 Zhenhua RD., Futian, Shenzhen, China





### FEATURES

- Converter and Evaluation Development (EVAL-CED1Z) compatibility**
- Versatile analog signal conditioning circuitry**
- On-board reference, clock oscillator and buffers**
- Buffered 16 bit parallel outputs**
- Buffered LVDS serial interface**
- Ideal for DSP and data acquisition card interfaces**
- PC software for control and data analysis**

### GENERAL DESCRIPTION

The EVAL-AD7625\_26EDZ is an evaluation board for the 32 lead AD7625 and AD7626 16-bit PulSAR® analog to digital converters (ADCs). These low power, ADCs offer very high performance of up to 6MSPS (AD7625) and 10MSPS (AD7626) throughput rates with a flexible parallel interface on the 96-pin interface. The evaluation board is designed to demonstrate the ADC's performance and to provide an easy to understand

interface for a variety of system applications. A full description of the AD7625 and AD7626 available in the Analog Devices data sheets and should be consulted when utilizing this evaluation board.

The evaluation board is ideal for use with Analog Devices Converter and Evaluation Development EVAL-CED1Z, (CED). The design offers the flexibility of applying external control signals and is capable of generating conversion results on parallel 16-bit wide buffered outputs.

On-board components include a high precision buffered band gap 4.096V reference, (ADR434), reference buffers (AD8031), a signal conditioning circuit with two op-amps (ADA4899-1), differential driver (ADA4932-1) and an FPGA for deserializing the LVDS serial conversion results.

The EVAL-AD7625\_26EDZ interfaces to the CED1Z capture board with a 96-pin DIN connector. SMB connectors are provided for the low noise analog signal source...

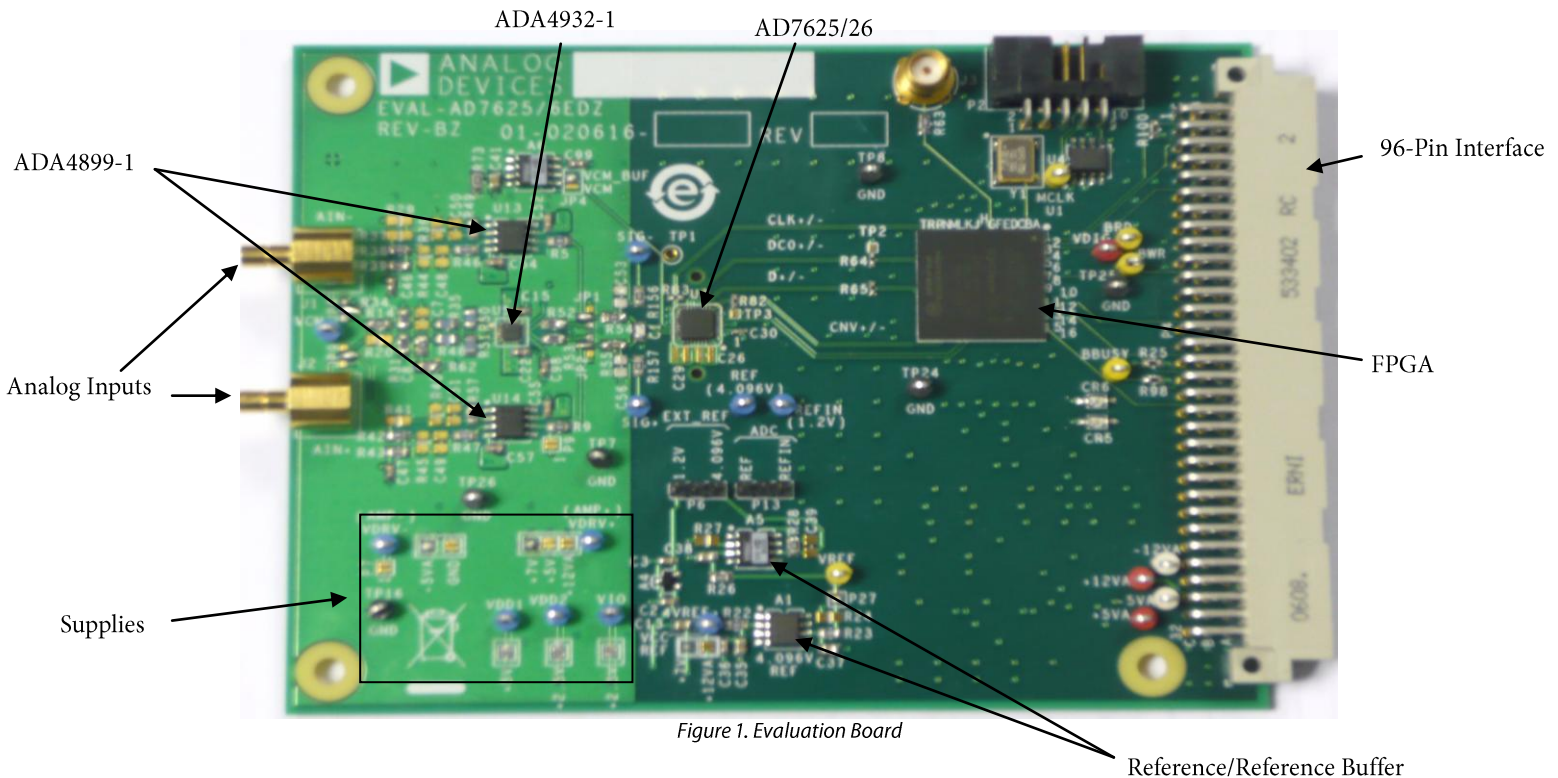

Figure 1. Evaluation Board

### Rev. PrC

Information furnished by Analog Devices is believed to be accurate and reliable. However, no responsibility is assumed by Analog Devices for its use, nor for any infringements of patents or other rights of third parties that may result from its use. Specifications subject to change without notice. No license is granted by implication or otherwise under any patent or patent rights of Analog Devices. Trademarks and registered trademarks are the property of their respective owners.

**TABLE OF CONTENTS**

FEATURES..... 1

GENERAL DESCRIPTION ..... 1

    Overview..... 3

    Conversion Control..... 3

    Analog Inputs..... 3

    Reference ..... 3

    Power Supplies and Grounding..... 3

    Schematics/PCB Layout..... 4

    Hardware Setup ..... 4

Software Installation .....5

Running the Software.....6

DC Testing - Histogram .....6

AC Testing.....6

Decimated AC Testing.....6

Bill Of Materials..... 22

Ordering Guide ..... 25

**LIST OF FIGURES**

Figure 1. Evaluation Board..... 1

Figure 2. Schematic, Power Supplies..... 9

Figure 3. Schematic, Reference ..... 10

Figure 4. Schematic, Analog..... 11

Figure 5. Schematic, ADC ..... 12

Figure 6. Schematic, 96-Pin Interface..... 13

Figure 7. Schematic, FPGA ..... 14

Figure 8. Setup Screen..... 15

Figure 9. Context Help..... 16

Figure 10. Histogram Screen..... 17

Figure 11. Summary ..... 18

Figure 12. FFT Spectrum..... 19

Figure 13. Oscilloscope..... 20

Figure 14. Decimated FFT..... 21

**LIST OF TABLES**

Table 1. Jumper Description..... 8

Table 2. Test Points (In order by type of signal) ..... 8

Table 3. Bill of Materials for the Connectors .....8

## OVERVIEW

Figure 1 shows the EVAL-AD7625\_26EDZ evaluation board. The on board FPGA, U1, provides the necessary control signals for conversion and deserializes the LVDS serial data as the CED1Z board uses a parallel interface. The evaluation board is a flexible design that enables the user to choose among many different board configurations, analog signal conditioning, reference, and different modes of conversion data.

## CONVERSION CONTROL

Conversion start (CNV+/-) controls the sample rate of the ADC and is the only input needed for conversion; all ADC timing is generated internally. Presently the evaluation board hardware and software are only supported for on-board generated CNV.

The on board FPGA does a number of digital functions, one of them being the deserializing the LVDS serial conversion results as the CED1Z data capture boards uses a 16-bit parallel interface. If desired, the deserialized data can be monitored on the 96-pin edge connector P4, BD15:0]. The CED1Z uses a buffered busy signal BBUSY as the general interrupt for data transfer and this can be monitored at the test point marked "BBUSY".

The AD7625/AD7626 use two modes of data transfer. (Refer to the datasheets for more details). One is a self clocked mode in which the data, D+/- is preceded by a zero and then a 2-bit header. The other mode is the "Echoed-Clock" interface in which the clock is echoed back out in phase with the data (3 LVDS pairs). The evaluation board and software currently supports the echoed-clock interface mode.

## ANALOG INPUTS

The analog input amplifier circuitry (U13, U14, U5 and discrete components) allows configuration changes such as positive or negative gain, input range scaling, filtering, addition of a DC component, use of different op-amp and supplies, and single ended to differential conversion.

The analog input amplifiers (U13 and U14) are set as unity gain buffers at the factory. The board is defaulted to use the ADA4899-1 devices as the driver amplifiers through the solder links JP9, JP6, JP1 and JP2.

The supplies for the amplifiers are selectable with solder pads and are set for the +7V/-5V ranges.

The default configuration sets both U13 and U14 at mid-scale generated from ADC7625/AD7626 on chip REF/2 output – which may be buffered or routed (JP4 selects the route) directly to the amplifiers.

For dynamic performance, an FFT test can be done by applying a very low distortion AC source. Since these ADCs are differential inputs, it is necessary to provide a fully-differential source. For low frequency testing, the Audio Precision sources can be used directly as the outputs on these are isolated. Set the outputs for balanced and floating. Different sources can be used however most are single ended and use a fixed output resistance. Since the evaluation board uses the amplifiers in unity gain, the non inverting input has a the common mode input with a series 590 ohm resistor and this needs to be taken into account when directly connecting a source.

The default setting on the analog front end routes the differential analog inputs from the connectors J1 and J2 to the 2xADA4899-1 amplifiers U13 and U14. An alternative option is to use the ADA4932-1 – typically, where the analog input frequency is of a higher value > 2MHz. The ADA4932-1 has a default setting of a single ended to differential driver with the single ended input applied to J1 it is routed to the input of the ADA4932-1 by setting JP6, JP1, JP2, and JP9 to the correct settings. Changing the settings on these solder links will allow the user to implement a single ended to differential conversion circuit using the U5 (ADA4932-1). This single ended to differential circuit is configured to 50-Ohm termination followed by a unity gain (inverting differential amplifier) stage around the ADA4932-1. With 50-Ohm source output impedance, this will give a gain of 0.5.

The ADA4932-1 is set up and balanced to give excellent noise and distortion performance from the AD7626. Please consult the ADA4932-1 datasheet to optimize the circuit for your application.

## REFERENCE

The AD7625/AD7626 have an internal 4.096V reference along with an internal buffer useful for using an external reference or can use directly an external 4.096V reference. The evaluation board can be configured to use any of these references. For using the internal ADC reference, leave P13 open (default). To use the ADR434, set P13 to connecting the centre pin marked "REF" and P6 to the "4.096V" option. (The 4.096V output of the ADR434 is buffered by an AD8031 in a unity gain configuration).

For using the internal reference buffer on the AD7625/AD7626 REFIN pin, set TP13 to the "REFIN" option and set P6 to the "1.2V" setting. The ADR280 (A4) sets the 1.2V reference voltage applied to REFIN, prior to the internal buffer in the AD7625/AD7626 device, which creates the required internal 4.096V.

## POWER SUPPLIES AND GROUNDING

The ground plane of the evaluation board is separated into two sections: a plane for the digital interface circuitry and an analog plane for the analog input and external reference circuitry. To attain high resolution performance, the board was designed to ensure that all digital ground return paths do not cross the analog ground return paths by connecting the planes together directly under the converter. Power is supplied to the board through P4 when using with the EVAL-CED1Z.

### **SCHEMATICS/PCB LAYOUT**

The EVAL-AD7625\_26EDZ is a 4-layer board carefully laid out and tested to demonstrate the specific high accuracy performance of the AD7625 and AD7626. Figure 2 to Figure 1 show the schematics of the evaluation board.

### **HARDWARE SETUP**

- EVAL-AD7625\_26EDZ evaluation board
- EVAL-CED1Z
- Enclosed World compatible 7V DC supply
- Enclosed USB to mini USB cable

Proceed to the Software Installation section to install the software. **Note: The EVAL-CED1Z board must not be connected to the PC's USB port until the Software is installed.** The 7V DC supply can be connected however to check the board has power (green LED lit).

**SOFTWARE INSTALLATION**

This section covers software installation. It is recommended to close all Windows’ applications prior to installing the software.

**System Requirements**

- PC operating Windows XP.
- USB 2.0 (for CED board)
- Administrator privileges

**CD-ROM** –Navigate Software\CED Version x.x, double click on *setup.exe* and follow the instructions on the screen. If another version of Analog Devices PulSAR Evaluation Software is present, it may be necessary to remove this. To remove, click on the Windows “Start” button, select “Control Panel” and “Add or Remove Programs”. When the list populates, navigate to Analog Devices High Resolution sampling ADC’s Evaluation Software or PulSAR Evaluation Software and select Remove.

**Website Download**

The software versions are also available from the Analog Devices PulSAR Analog to Digital Converter Evaluation Kit page. After downloading the software, it is recommended to use the WinZip “Extract” function to extract all of the necessary components as opposed to just clicking on *setup.exe* in the zipped file. After extracting, click on *setupe.exe* in the folder created during the extraction and follow the instructions on the screen. If another version exists, it may be necessary to remove as detailed in the above CD-ROM section.

**USB Drivers**

The software will also install the necessary USB drivers. After installing the software, power up the CED board and connect to the PC USB 2.0 port. The Windows “Found New Hardware” Wizard will display. Click on Next to install the drivers automatically.

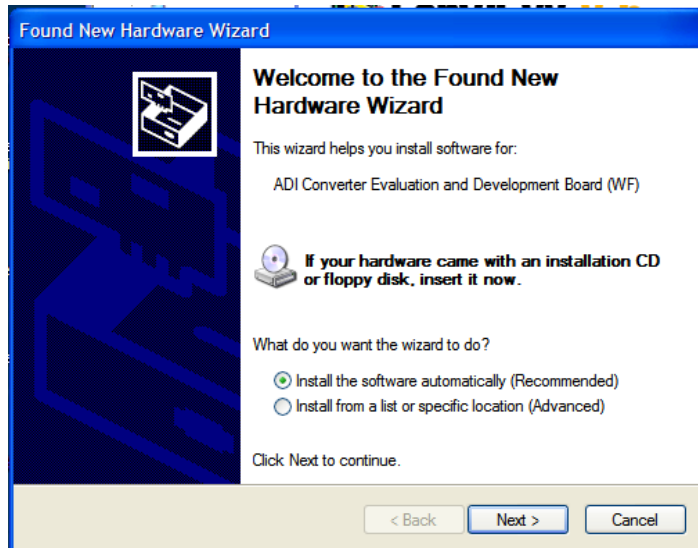

When installed properly, Windows displays the following.

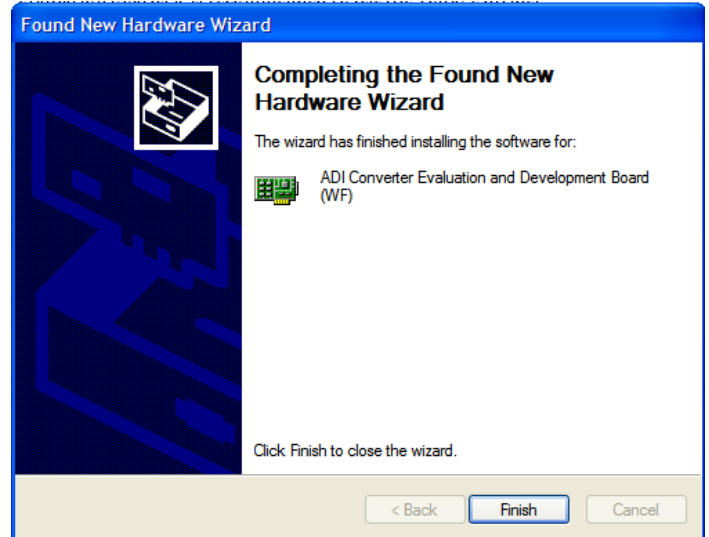

On some PCs, the Found New hardware Wizard may show up again and if so follow the same procedure to install it properly.

The “Device Manager” can be used to verify that the driver was installed successfully.

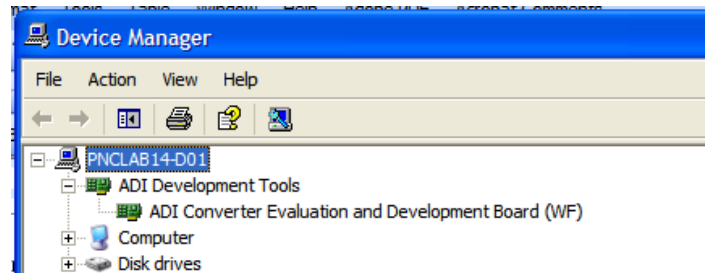

**Troubleshooting the Install**

If the driver was not installed successfully the device manager will display a question mark for “Other devices” as Windows does not recognize the CED1Z board.

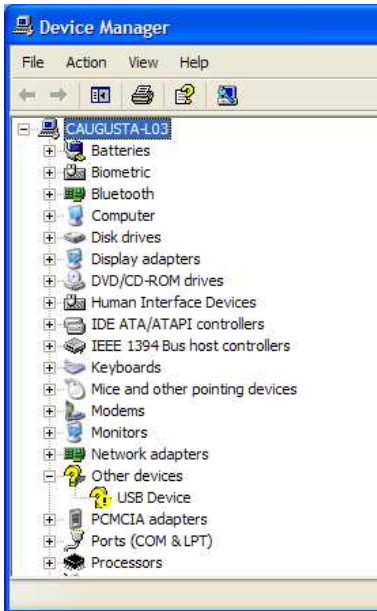

The “USB Device” can be opened to view its uninstalled properties.



This is usually the case if the software and drivers were installed by a user without administrator privileges. If so, log on as an administrator with full privileges and reinstall the software.

## RUNNING THE SOFTWARE

The evaluation board includes software for analyzing the AD7625 and AD7626 6MSPS and 10MSPS 16-bit ADC's. The EVAL-CED1Z is required when using the software. The software is used to perform the following tests:

- Histogram for determining code transition noise (DC)
- Fast Fourier transforms (FFT) for signal to noise ratio (SNR), SNR and distortion (SINAD), total harmonic distortion (THD) and spurious free dynamic range (SFDR)
- Decimation (digital filtering)

Refer to Figure 8 to Figure 14 for further details and features of the software.

The software is located at C:\Program Files\Analog Devices\AD7625\_26 Evaluation Software\High-Res ADC Eval SW x\_x.exe.

A shortcut is also added to the Windows “Start” menu under “Analog Devices AD7625\_26 ADC Evaluation Software”, “AD7625\_26 Eval SW x\_x”. To run the software, select the program from either location.

## DC TESTING - HISTOGRAM

This tests the ADC for the code distribution for DC input and computes the mean and standard deviation, or transition noise of the converter and displays the results. Raw data is captured and passed to the PC for statistical computations. To perform a histogram test, select “Histogram” from the test selection window and click on the “Start” radio button. Note: a histogram test can be performed without an external source since the evaluation board has a buffered  $V_{REF}/2$  source at the ADC input. To test other DC values, apply a source to the J1/J2 inputs. It is advised to filter the signal to make the DC source noise compatible with that of the ADC. Install C48/C49 to provide this filtering if necessary.

## AC TESTING

This tests the traditional AC characteristics of the converter and displays a Fast Fourier Transform (FFT) of the result. As in the histogram test, raw data is captured and passed to the PC where the FFT is performed displaying SNR, SINAD, THD and SFDR. The data can also be displayed in the time domain. To perform an AC test, apply a sinusoidal signal to the evaluation board at the SMB inputs J1/J2. Low distortion, better than 93dB, is required to allow true evaluation of the part. One possibility is to filter the input signal from the AC source. There is no suggested band pass filter but consideration should be taken in the choice. Furthermore, if using a low frequency bandpass filter when the full-scale input range is more than a few  $V_{pp}$ , it is recommended to use the on board amplifiers to amplify the signal, thus preventing the filter from distorting the input signal.

## DECIMATED AC TESTING

The AC performances can be evaluated after digital filtering with enhanced resolution of up to 32 bits. Additional bits of resolution are attained when over sampling by equation 1.

1.  $f_{\text{OVERSAMPLE}} = 4^N * f_{\text{SAMPLE}}$

where, N = number of bits of increased resolution and  $4^N$  = the decimation ratio. Set the decimation to the amount of over sampling desired. Equation 1. is useful when the increased resolution is known. Example: to increase a 16-bit converter to 18-bits, N=2 thus the oversampling ratio would be 16. Since the software uses  $2^N$ , the number entered must be 4.

Equation 2. is useful when the increase in SNR is desired.

2.  $SNR_{\text{gain}}(dB) = 10 \log(\text{OversampleRatio})$

For example, for a 10dB increase in , the oversampling ratio must be 10X.



**Table 1. Jumper Description**

| Jumper               | Name | Default Position | Function  |
|----------------------|------|------------------|---|
| JP1, JP2<br>JP9, JP6 | -    | U13, U14         | Buffer amplifier: Default for U13/U14 output. Use op amps to buffer analog input. Top pad to middle pad, input from J1, J2 (SMB). |
| VDRV-                | -    | -5V              | Buffer amplifier negative supply: Selection of -12V or -5V.   |
| VDRV+                | -    | +7V              | Buffer amplifier positive supply: Selection of +12V, +7V or +5V.  |
| VCC REF              | -    | +12V             | Reference circuit positive supply: Selection of +12V or +7V.  |
| VDD1                 | -    | +5V              | ADC VDD1 5V supply: Selection of 5V on board or external.   |
| VDD2                 | -    | +2.5V            | ADC VDD2 2.5V supply: Selection of 5V on board or external.   |
| VDDR                 | -    | +5V              | ADC VDD1 5V supply: Selection of 5V on board or external.   |
| VIO                  | -    | +2.5V            | ADC digital input/output supply voltage: Selection of 2.5V  |

**Table 2. Test Points (In order by type of signal)**

| Test Point                                    | Available Signal | Type                               | Description  |
|---|------------------|------------------------------------|--|
| TP1   | SIG+             | Analog Input                       | Analog +input.   |
|   | SIG-             | Analog Input                       | Analog -input.   |
|   | REF              | Analog Input/Output                | ADC Reference. Output if the AD7625/AD7626 internal reference is enabled. Input if internal reference is disabled.   |
|   | REFIN            | Analog Input/Output                | ADC bandgap output/reference buffer input. 1.2V present if the AD7625/AD7626 internal reference is enabled. Connect a 1.2V source if the internal bandgap is disabled and the reference buffer is enabled. |
|   | MCLK             | Digital Input                      | 100MHz FPGA master clock input.  |
|   | BWR              | Digital Input                      | EVAL-CED1Z buffered /WR strobe   |
|   | BBUSY            | Digital Output                     | EVAL-CED1Z buffered BUSY strobe  |
|   | BRD              | Digital Input                      | EVAL-CED1Z buffered /RD strobe   |
|   | VDD1             | Power                              | AD7625/AD7626 VDD1.  |
|   | VDD1             | Power                              | AD7625/AD7626 VDD1.  |
|   | VDD2             | Power                              | AD7625/AD7626 VDD2.  |
|   | VDRV+            | Power                              | Positive rail amplifier supply (AMP +)   |
|   | VDRV-            | Power                              | Negative rail amplifier supply (AMP -)   |
|   | VIO              | Power                              | AD7625/AD7626 VIO.   |
|   | 4V REF           | Reference                          | ADR434 output voltage  |
|   | -5VA             | Power                              | -5V analog from EVAL-CED1Z board.  |
|   | +5V              | Power                              | +5V analog from EVAL-CED1Z board.  |
|   | -12VA            | Power                              | -12V analog from EVAL-CED1Z board.   |
| +12VA   | Power            | +12V analog from EVAL-CED1Z board. |  |
| TP7,TP8,<br>TP16, TP23,<br>TP24,<br>TP25,TP26 | GND              | GND                                | System GND.  |

**Table 3. Bill of Materials for the Connectors**

| Ref Des | Connector Type             | Manf.      | Part No. |
|---------|----------------------------|------------|----------|
| J1, J2  | RT Angle SMB Male          | Pasternack | PE4177   |
| P4      | 32X3 RT PC MOUNT CONNECTOR | ERNI       | 533402   |

| REVISIONS |             |      |          |
|-----------|-------------|------|----------|
| REV       | DESCRIPTION | DATE | APPROVED |
|           |             |      |          |

# POWER SUPPLIES

## FPGA SUPPLIES

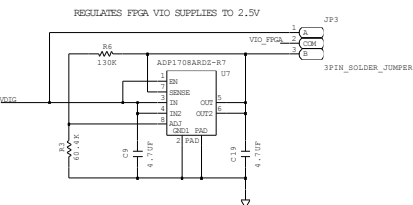
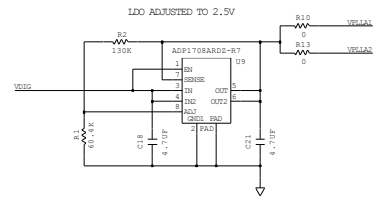
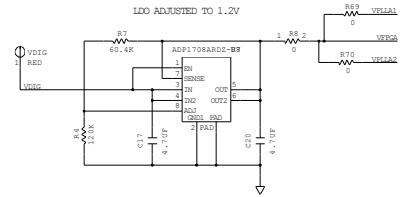

## ANALOG SUPPLIES

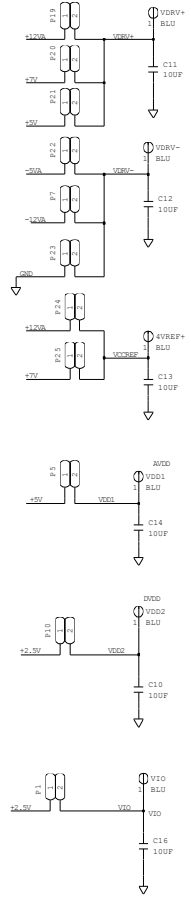
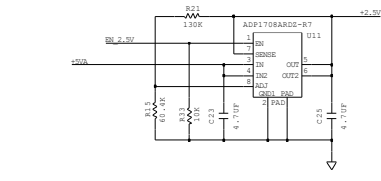
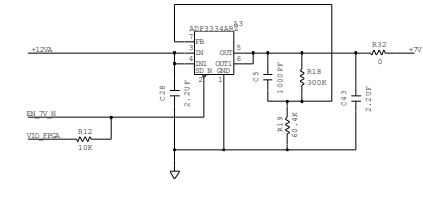
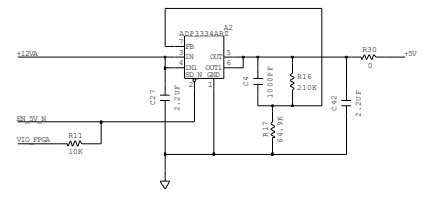

|  |   |                          |              |
|--|---|--------------------------|--------------|
|  | SCHEMATIC   |                          |              |
|  | <DRAWING TITLE HEADER><br>AD7626/5/7 EVAL BO Z<br><PRODUCT 1> |                          |              |
|  | DESIGN VIEW<br>PDS ENGINEER<br><PDS ENGINEER>                 | DRAWING NO.<br>02-020616 | REV<br>B     |
|  | SIZE<br>D   | SCALE<br>-               | SHEET 1 OF 6 |

Figure 2. Schematic, Power Supplies



| REVISIONS |             |      |          |
|-----------|-------------|------|----------|
| REV       | DESCRIPTION | DATE | APPROVED |
|           |             |      |          |

## ADC BUFFERS

\*\* NO GND OR POWER UNDER THE NODES MARKED IN RED. \*\*

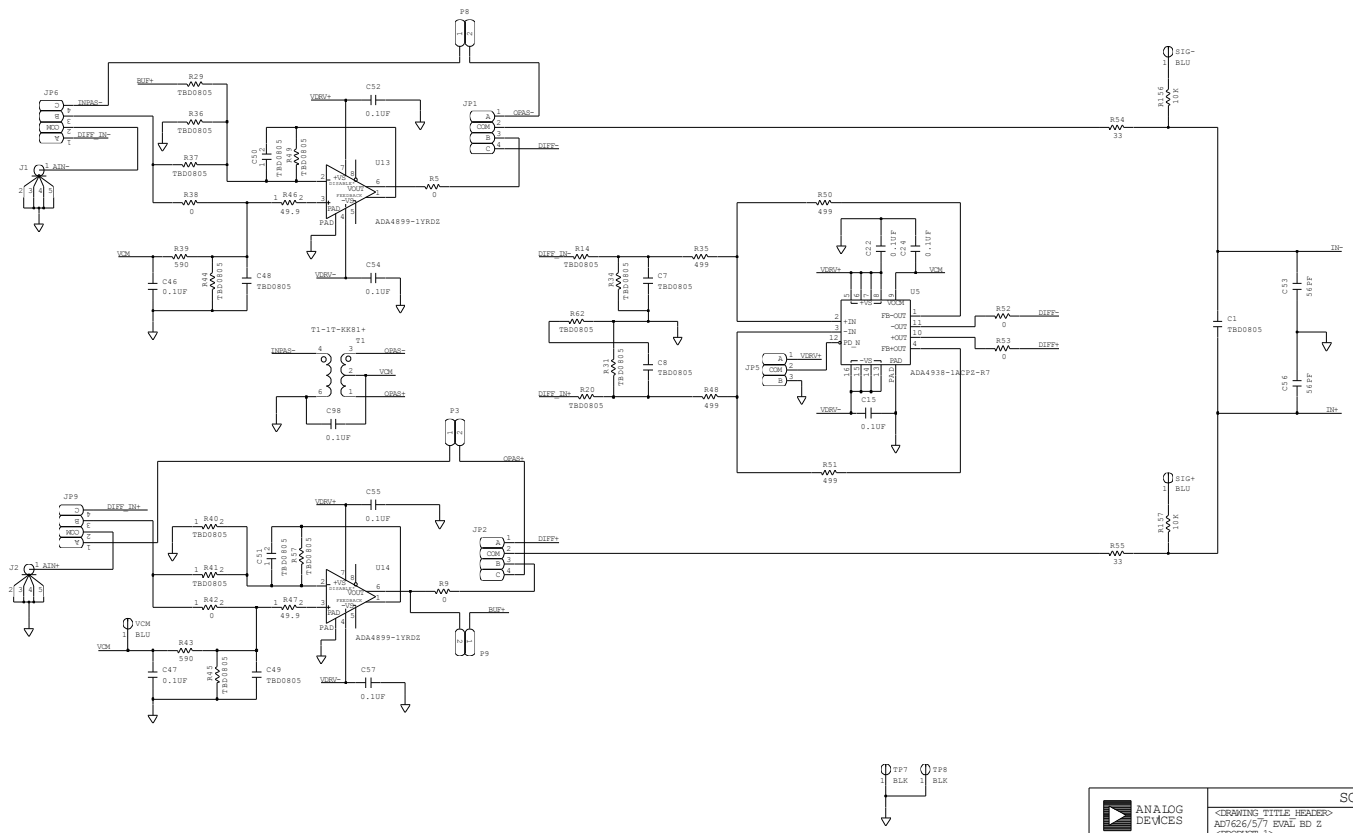

| ANALOG DEVICES  |  | SCHEMATIC   |      |
|---|--|-------------|------|
| <DRAWING TITLE HEADER><br>AD7626/571 EVAL BD Z<br><PRODUCT 1> |  |             |      |
| DESIGN VIEW   |  | FRAMING NO. | REV  |
| PTD ENGINEER<br><PTD ENGINEER>                                |  | 02-020616   | B    |
| SITE SCALE<br><PTD ENGINEER>                                  |  | SHEET 3     | OF 6 |

Figure 4. Schematic, Analog



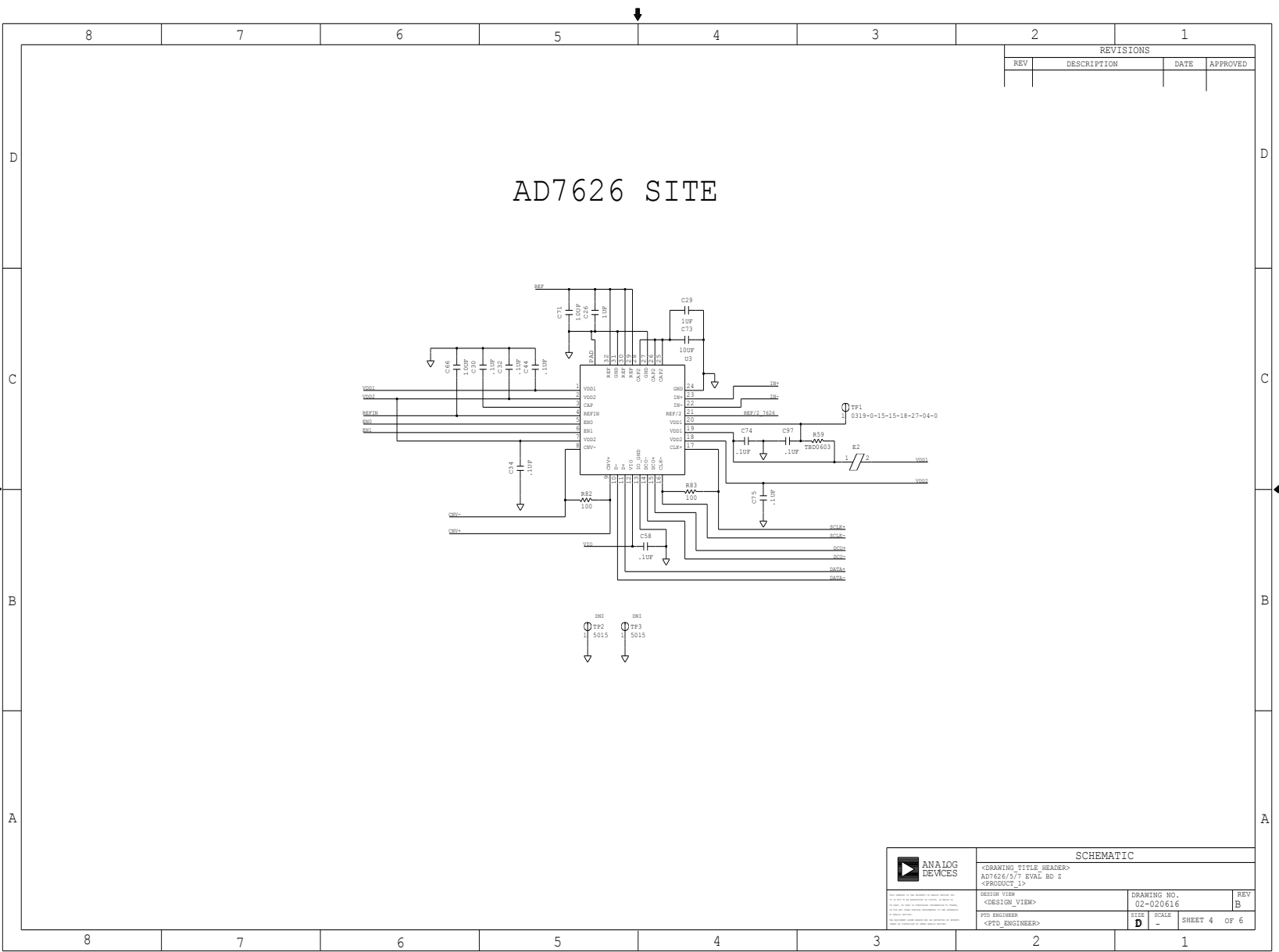
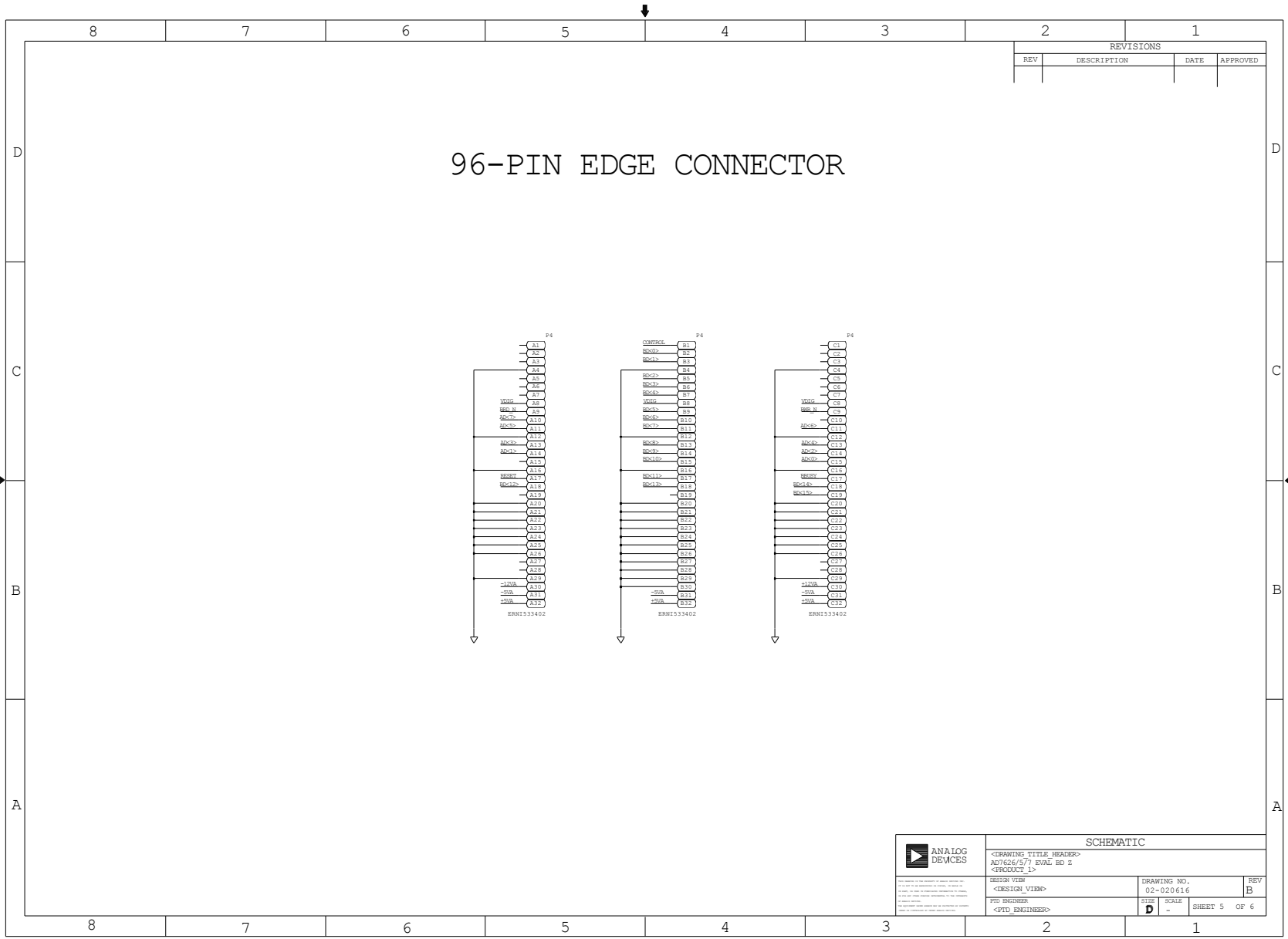

Figure 5. Schematic, ADC



| REVISIONS |             |      |          |
|-----------|-------------|------|----------|
| REV       | DESCRIPTION | DATE | APPROVED |
|           |             |      |          |

|  |   |              |            |
|--|---|--------------|------------|
|  | SCHEMATIC   |              | REV        |
|  | <DRAWING TITLE HEADER><br>AD7625/577 EVAL RD Z<br><PRODUCT 1> |              | B          |
| DESIGN VIEW<br><DESIGN VIEW><br>PTD ENGINEER<br><PTD ENGINEER> | DRAWING NO.<br>02-020614                                      | SHEET 5 OF 6 | SCALE<br>- |

Figure 6. Schematic, 96-Pin Interface

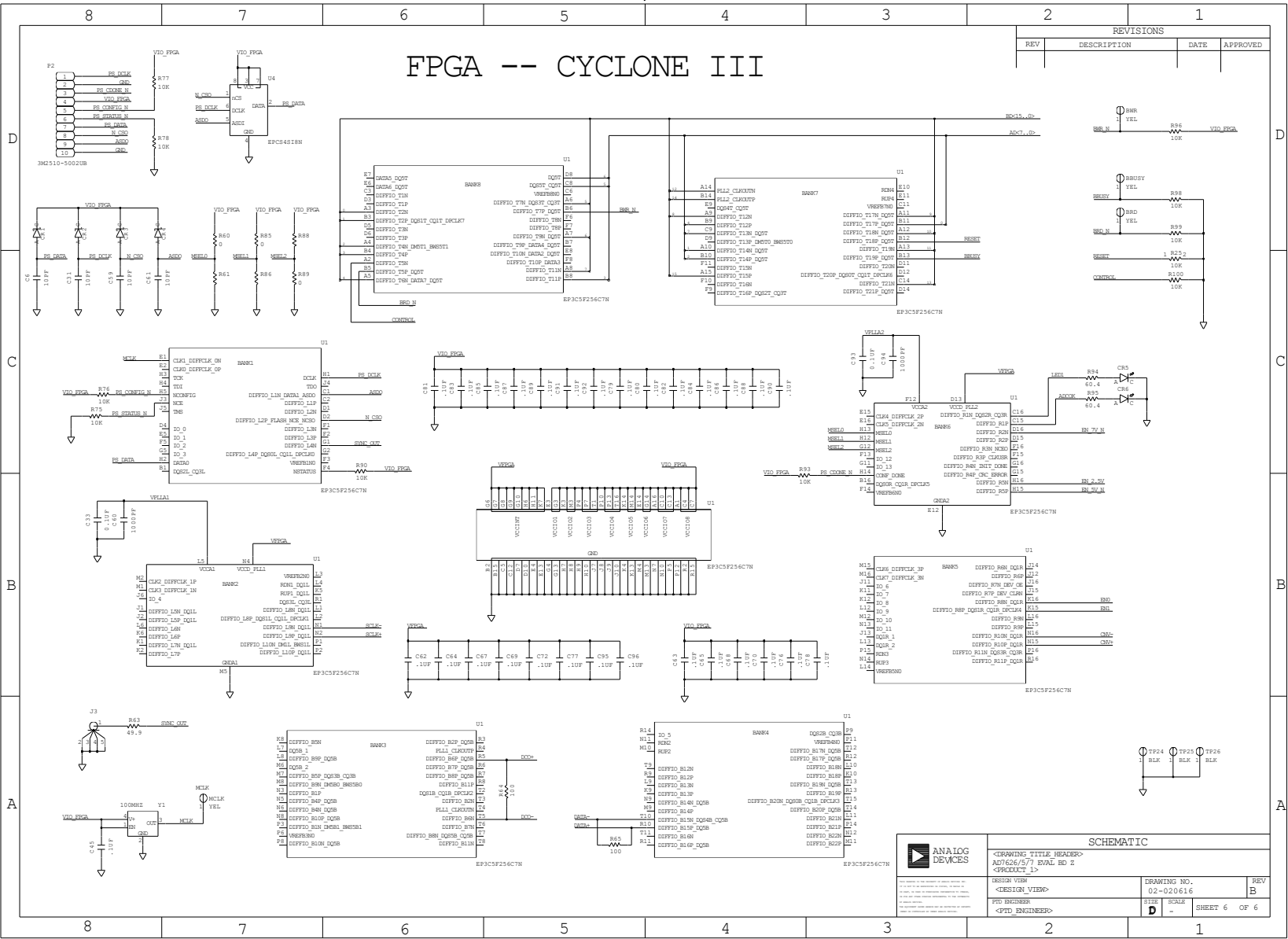

Figure 7. Schematic, FPGA

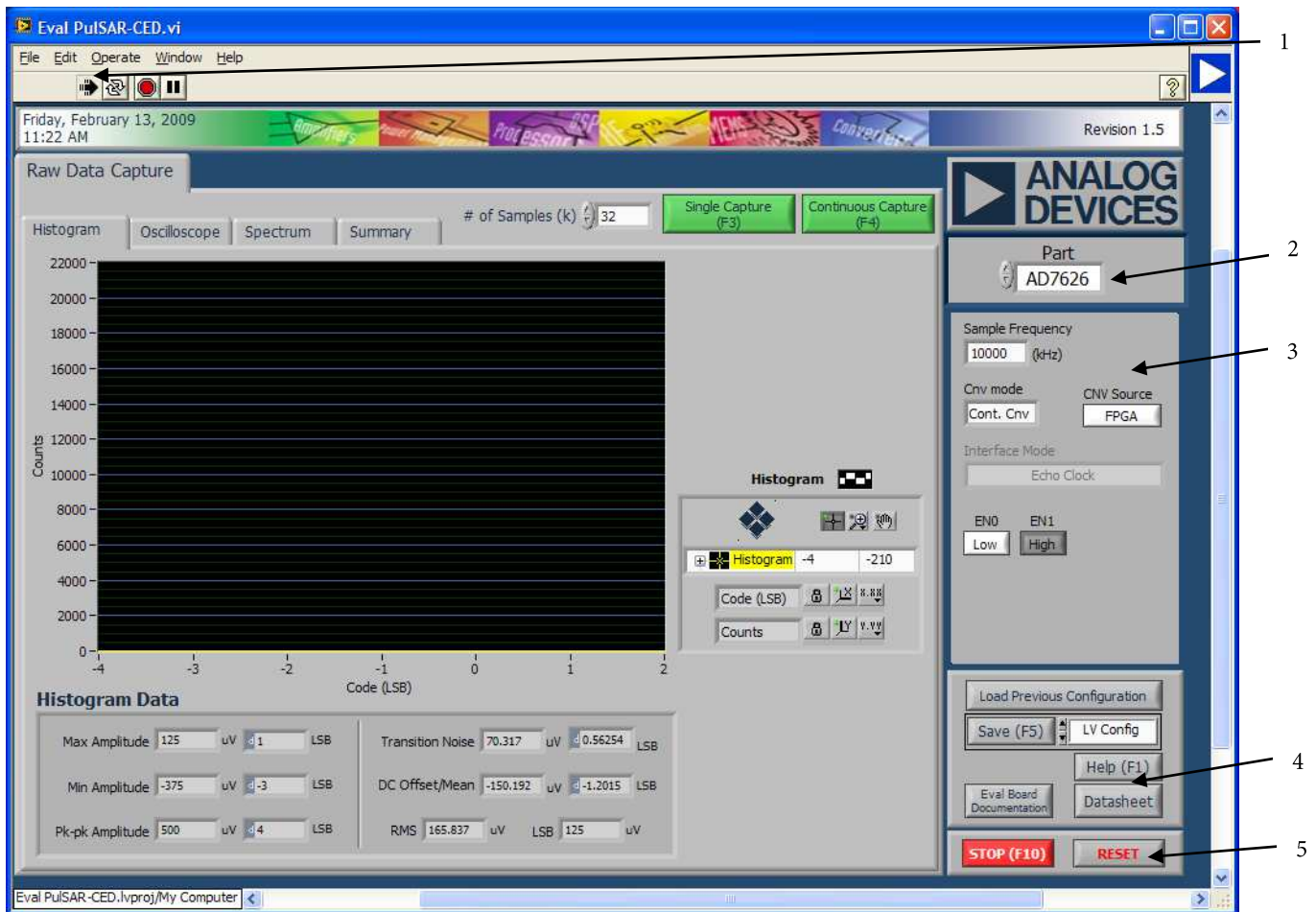



Figure 8. Setup Screen

The following details the operation of the C:\Program Files\Analog Devices\AD7625\_26 Evaluation Software\High-Res ADC Eval SW 1\_3.exe software.

1. The arrow  is used to start the software. When running  is displayed.

2. The part to be evaluated is selected here.

3. The controls are used to set:

**Sample Frequency** – Enter the sample in kHz. Units can be used such as 10k (case sensitive) for 10,000,000 Hz or 10MSPS.

**CNV Source** - Selections between evaluation board or external.

**CNC Mode** – This selects between continuous (Cont.) or Burst conversion modes. In continuous mode, the ADC is continuously converting. In burst mode, the ADC is not converting (sample clock held in inactive state) and the conversions begin once the “Single Capture” or “Continuous Capture” buttons have been selected. Note that at this time, burst mode does not work and is simply a place holder for future software versions.

**EN0, EN1** – These controls toggle the EN[1:0] AD7625/AD7626 pins and can be used to power down the ADC, power down the internal reference, etc.

4. These controls are used for saving, printing, help, etc. and are also accessed in the File menu.

Save (F5): type – LabView config, allows the current configuration to be saved to a *filename.dat* file. Useful when changing many of the default controls. To load the saved configuration, use the Load Previous Configuration.

Type – Html, saves the current screen shot to an Html file.

Type – Spreadsheet, saves the current data displayed in the chart in a tab delimited spreadsheet. Raw ADC Data is time domain in V or Code, FFT or Decimated is in dB.

5. Stop (F10) is used to stops the software. The  can also be used to stop the software. RESET is used to reset the CED or ECB capture boards.



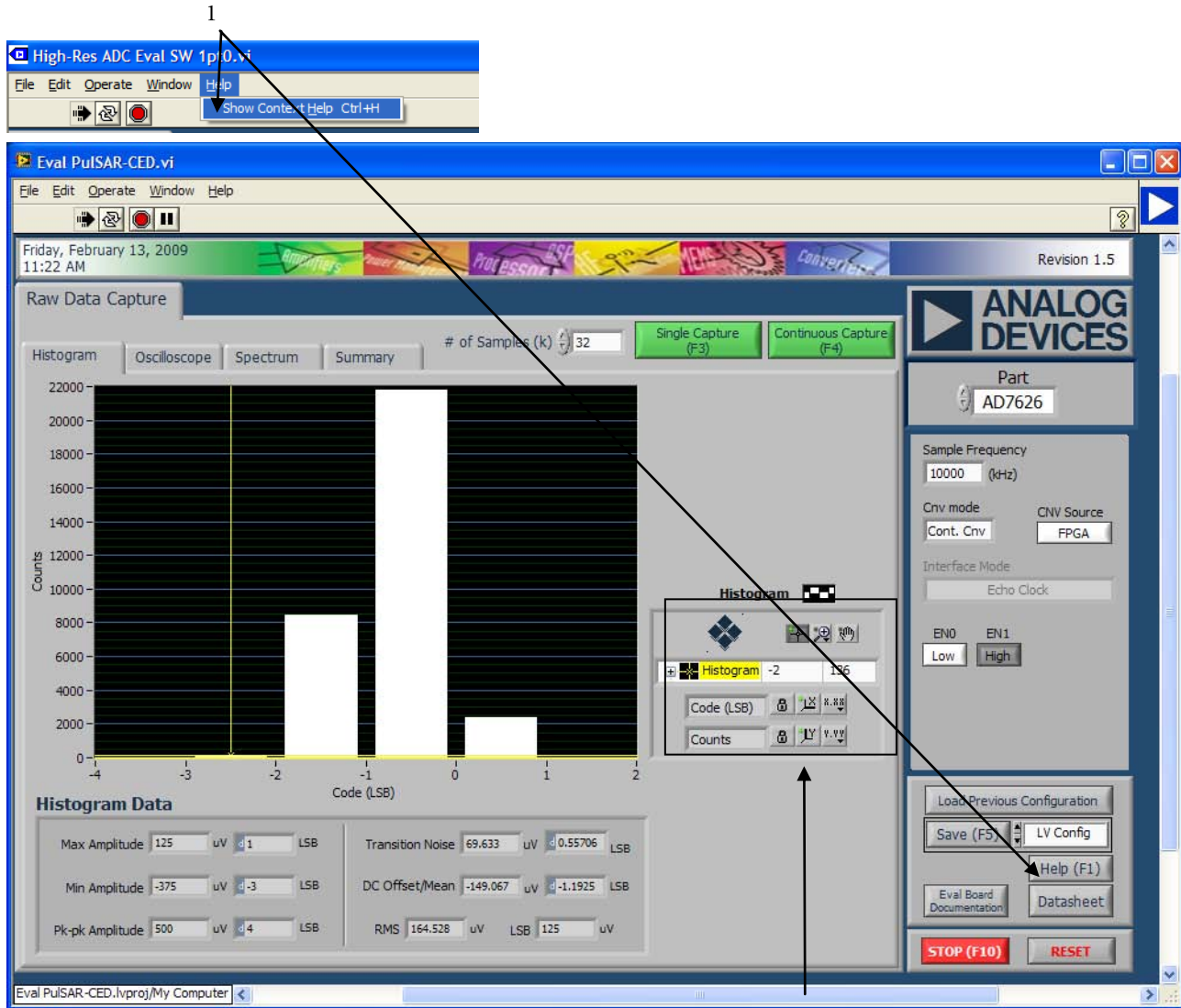

Figure 9. Context Help

1. To use the on-screen help. Select Help, Show Context Help or click the Help (F1). Placing the cursor on most screen items displays useful help for the particular control or displayed unit.

2. These controls are used for axes and zooming panning.

- Locks the graph axis to automatically fit the data.
- Uses last axis set by user. rescale the axes to the automatic values.
- are used to set axes properties such as format, precision, color, etc.

- Displays the cursor.
- Is used For zooming in and out.
- Is used for panning.
- Is used to set various graph properties such as graph type, colors, lines, etc.

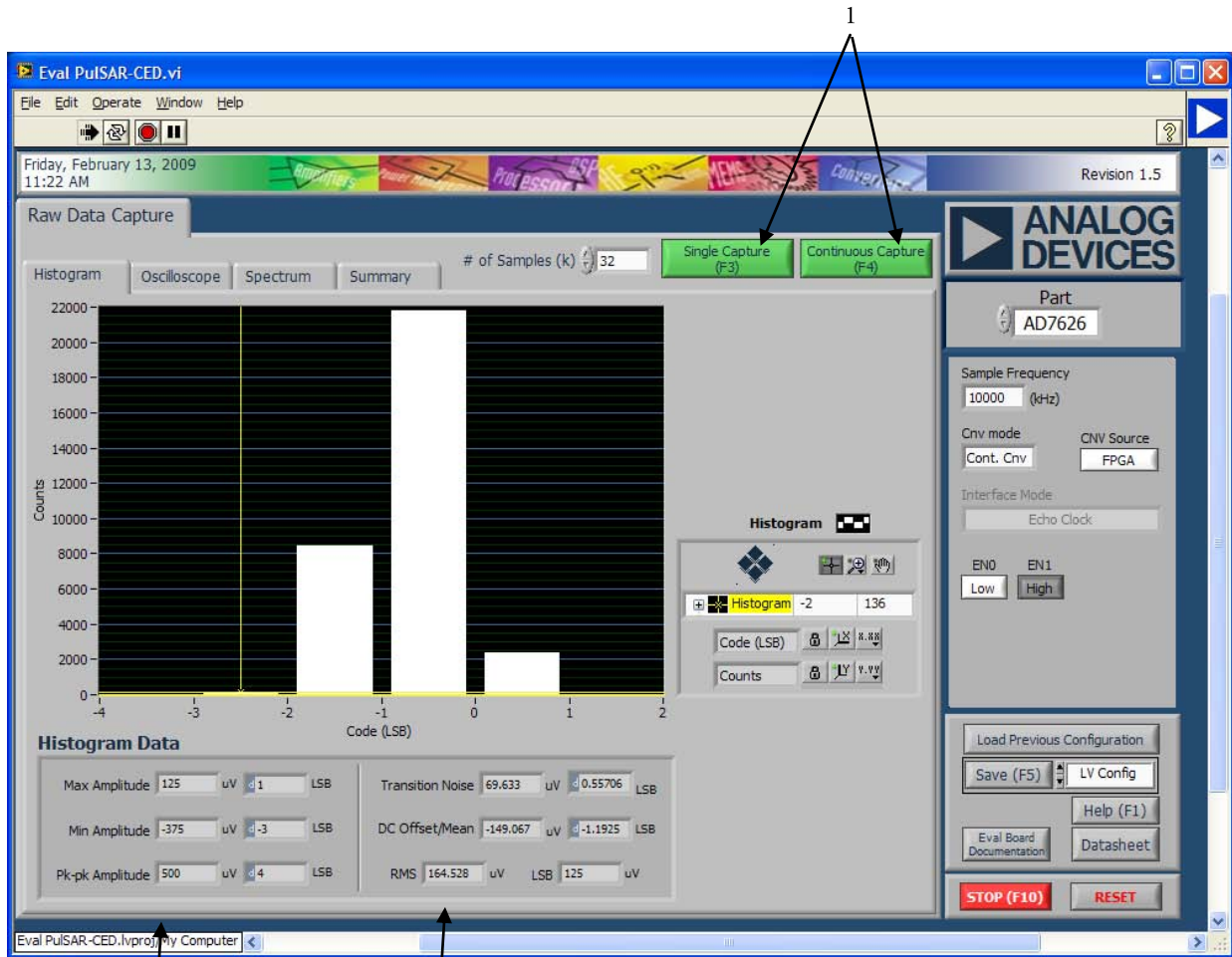
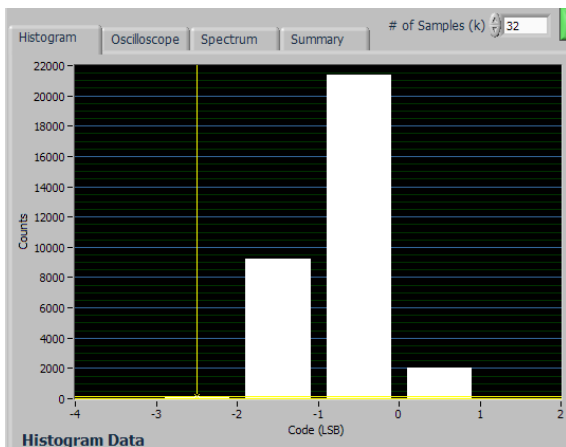
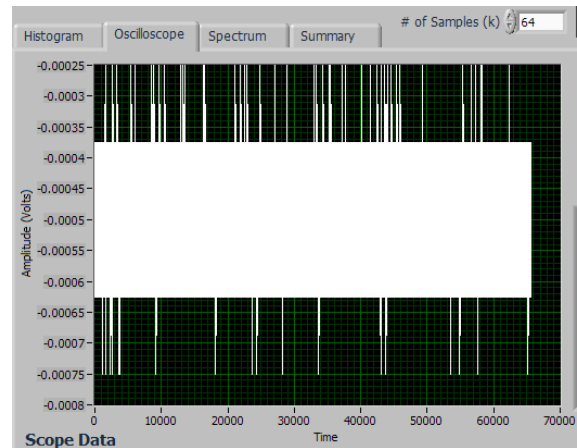

Figure 10. Histogram Screen

1. These radio buttons are used to perform a Single Capture or Continuous Capture of data set in the # of Samples field. The results are displayed in the chart. Note that the results can be displayed as:



A Histogram



Or an Oscilloscope (time domain)

2., 3. These display the statistics for the X and Y-axes, respectively.

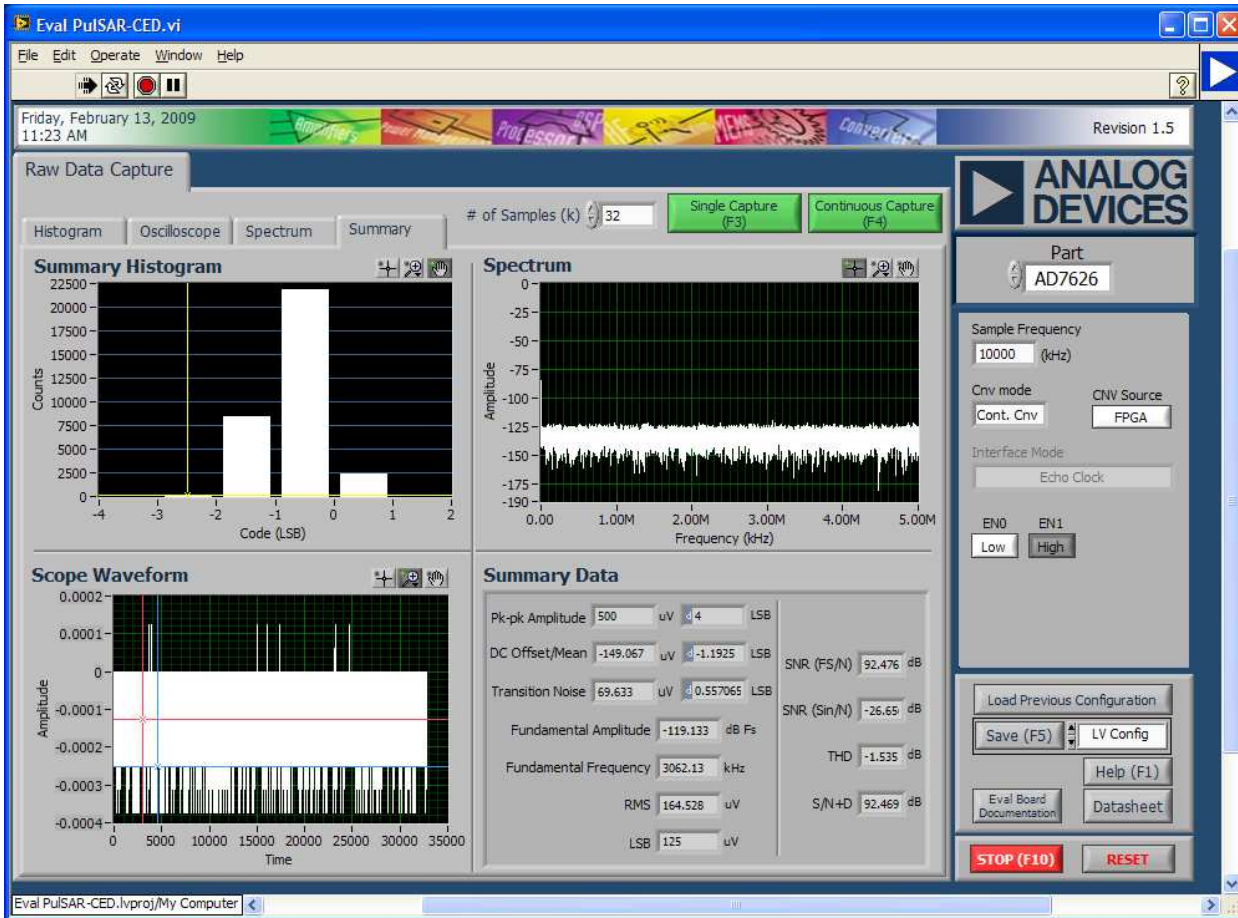

Figure 11. Summary

The charts can be displayed together when the **Summary** tab is selected.

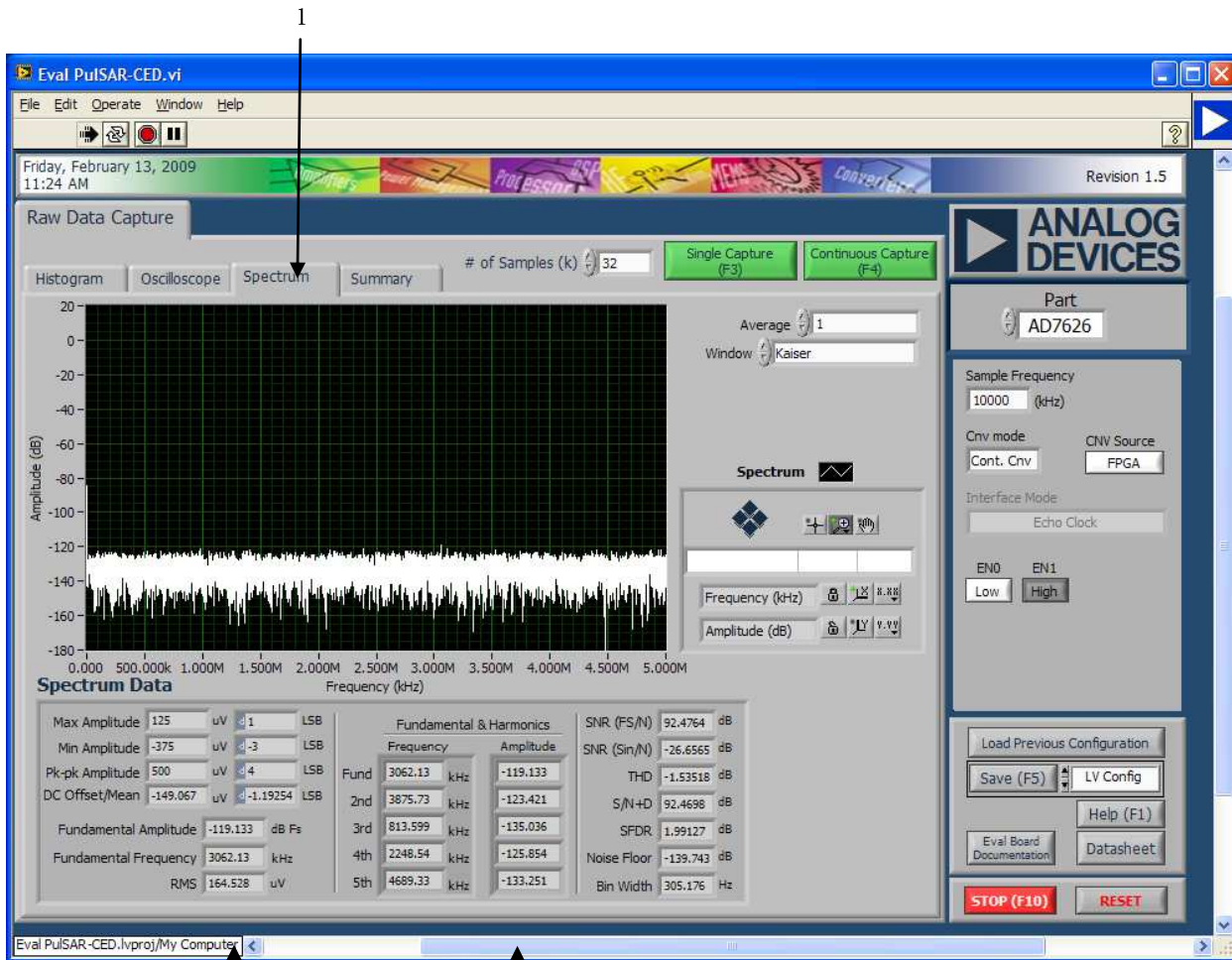

Figure 12. FFT Spectrum

1. Displays the FFT when the Spectrum chart is selected
- 2., 3. Display the data for the X and Y-axes, respectively.



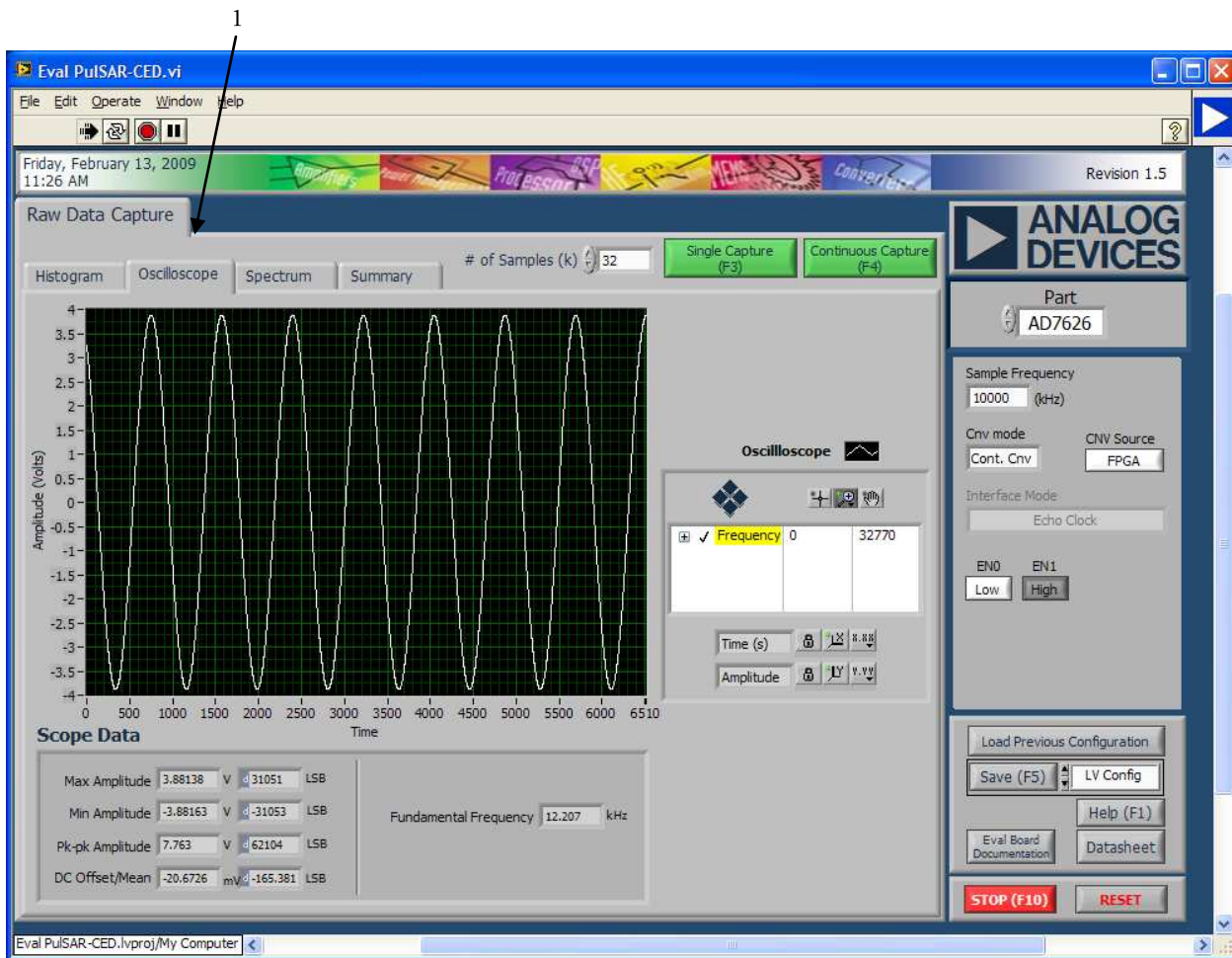

Figure 13. Oscilloscope

1. Time domain data can be viewed with the oscilloscope also.

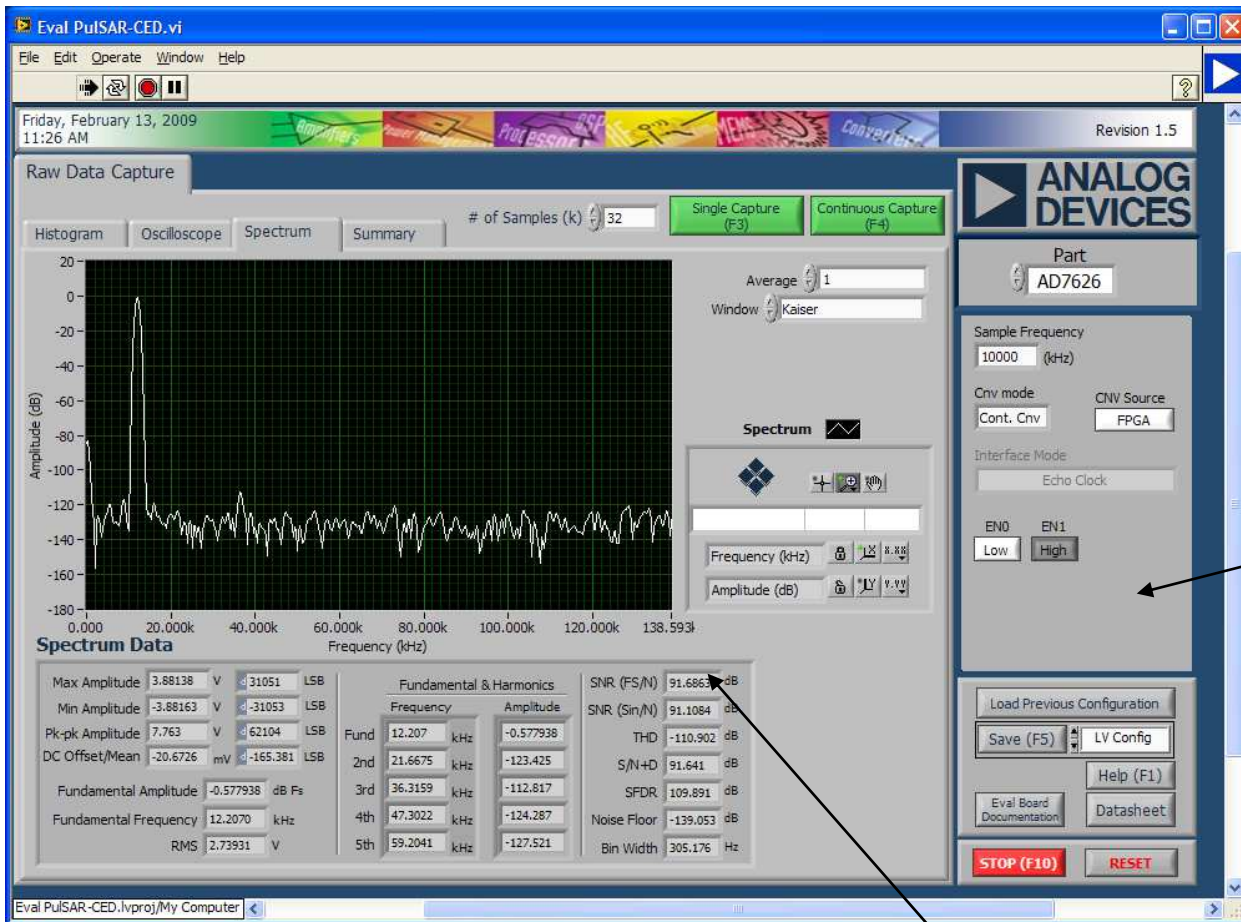

Figure 14. Decimated FFT

1. Enter a value to oversample the ADC for increased system resolution as detailed in the Decimated AC Testing section. Note that for every power of 4, the effective resolution increases by 6dB or 1 bit (power of 10, increases by 10dB). Since the software uses  $2^n$  to decimate, use  $n+n$  for the increase in bits. Example, oversample for 1 more bit of resolution would be  $2^2$ ; oversample for 2 bits more of resolution =  $2^4$ , etc.

4. The Nyquist frequency is displayed as:

$$F_{NYQUIST} = \frac{SampleFrequency}{2^{(N+1)}}$$

**BILL OF MATERIALS**

| <b>Name</b>   | <b>Value</b>    | <b>Description</b>       | <b>Manufacturer</b>    | <b>Manufacturer Part #</b> |
|---|-----------------|--------------------------|------------------------|----------------------------|
| +5VA,VDIG,+12VA   | RED             | CONN-PCB TST PNT RED     | COMPONENTS_CORPORATION | TP-104-01-02               |
| -5VA,-12VA  | WHT             | CONN-PCB TST PNT WHT     | COMPONENTS_CORPORATION | TP-104-01-09               |
| REF,VCM,VIO,SIG+,SIG-,VDD1,VDD2,REFIN,VDRV+,VDRV-,4VREF+          | BLU             | CONN-PCB TST PNT BLU     | COMPONENTS_CORPORATION | TP104-01-06                |
| A1  | ADR434BRZ       | 4.096 VOLTAGE REF        | ADI                    | ADR435BRZ                  |
| A2,A3   | ADP3334ARZ      | LOW IQ ADJ LOW DROP REG  | ADI                    | ADP3334ARZ                 |
| A4  | ADR280ARTZ      | 1.2V ULTRALOW VOLT REF   | ADI                    | ADR280ARTZ                 |
| A5,A6   | AD8031BRZ       | RAIL-RAIL I/O AMP        | ADI                    | AD8031BRZ                  |
| BRD,BWR,MCLK,VREF,BBUSY   | YEL             | CONN-PCB TST PNT YEL     | COMPONENTS_CORPORATION | TP-104-01-04               |
| C1,C7,C8,C39,C48-C51  | TBD0805         | DO NOT INSTALL           | TBD0805                | TBD0805                    |
| C10-C14,C16,C35,C38,C41,C66,C71,C73                               | 10UF            | CERAMIC CAP              | MURATA                 | GRM21BR61C106KE15L         |
| C2,C3,C15,C22,C24,C33,C36,C40,C46,C47,C52,C54,C55,C57,C93,C98,C99 | 0.1UF           | E007204                  | PANASONIC              | ECJ-1VB1C104K              |
| C9,C17-C21,C23,C25  | 4.7UF           | CAP CER X5R              | MURATA                 | GRM21BR61E475KA12L         |
| C26,C29   | 1uF             | CAP CER LLL219           | MURATA                 | LLL219R70J105MA01L         |
| C27,C28,C37,C42,C43   | 2.2UF           | CAP CER                  | MURATA                 | GRM21BR71E225KA73L         |
| C30,C32,C34,C44,C45,C58,C62-C65,C67-C70,C72,C74-C92,C95-C97       | .1UF            | E006560/A004-0011-066    | PHYCOMP (YAGEO)        | 04022F104Z7B20D            |
| C6,C31,C59,C61  | 10PF            | CAP CER NP0              | PANASONIC              | ECU-VIH100FCV              |
| C4,C5   | 1000PF          | CAP CER NP0              | PANASONIC              | ECU-V1H102JCX              |
| C53,C56   | 56PF            | CAP CER NP0              | PANASONIC              | ECU-V1H560JCG              |
| C60,C94   | 1000PF          | E000208/A004-0008-005    | PANASONIC              | ECH-U1H102JB5              |
| CR1-CR4   | B220A-13-F      | DIODE SCHOTTKY RECTIFIER | DIODES INCORPORATED    | B220A-13-F                 |
| CR5,CR6   | CMD28-21VGCTR8T | DIODE LED GREEN SMD      | CHICAGO MINI LAMP      | CMD28-21VGCTR8T1           |

# Preliminary Technical Data

# EVAL-AD7625/26EDZ

| Name  | Value                | Description                    | Manufacturer  | Manufacturer Part #   |
|---|----------------------|--------------------------------|---------------|-----------------------|
|   | 1                    |                                |               |                       |
| E2  | BMB2A1000 LN2        | FERRITE CHIP BEADS             | MEGGITT SIGMA | FEC 323-7989          |
| J1,J2   | JOHNSON1 31-3701-301 | COAX SMB RA                    | JOHNSON       | 131-3701-301          |
| J3  | JOHNSON1 42-0701-201 | CONN-PCB COAX SMA ST           | JOHNSON       | 142-0701-201          |
| P6,P13  | MOLEX22-03-2031      | STRAIGHT HEADER 3PIN           | MOLEX         | 22-03-2031            |
| P2  | 3M2510-5002UB        | HDR SHRD RA 10P MALE           | 3M            | 2510-5002UB           |
| P4  | ERNI533402           | DIN RA 96P MALE                | ERNI          | 533402                |
| R1,R3,R7,R15,R19  | 60.4K                | RES THICK FILM CHIP R0805      | PANASONIC     | ERJ-6ENF6042V         |
| R5,R8-R10,R13,R22,R23,R30,R32,R38,R42,R52,R53,R60,R69,R70,R85,R89 | 0                    | RES JMPR SMD 0805 (SHRT)       | PANASONIC     | ERJ-6GEYJ0.0          |
| R25,R75-R78,R90,R93,R96,R98-R100                                  | 10K                  | RES PREC THICK FILM CHIP R0603 | PANASONIC     | ERJ-3EKF1002V         |
| R11,R12,R33,R156,R157   | 10K                  | RES PREC THICK FILM CHIP R0805 | PANASONIC     | ERJ-6ENF1002V         |
| R14,R20,R24,R27,R29,R31,R34,R36,R37,R40,R41,R44,R45,R49,R57,R62   | TBD0805              | DO NOT INSTALL                 | TBD0805       | TBD0805               |
| R16   | 210K                 | RES PREC THICK FILM CHIP R0805 | PANASONIC     | ERJ-6ENF2103V         |
| R17   | 64.9K                | RES PREC THICK FILM CHIP R0805 | PANASONIC     | ERJ-6ENF6492V         |
| R18   | 300K                 | RES CHIP SMD 0805              | YAGEO         | RC0805FR-07300KL      |
| R2,R6,R21   | 130K                 | RES PREC THICK FILM CHIP R0805 | PANASONIC     | ERJ-6ENF1303V         |
| R26,R28   | 1K                   | RES PREC THICK FILM CHIP R0805 | PANASONIC     | ERJ-6ENF1001V         |
| R35,R48,R50,R51   | 499                  | RES CHIP SMD 0805              | IRC           | PFC-W0805R-03-4990-B  |
| R39,R43   | 590                  | RES PREC THICK FILM CHIP R0805 | PANASONIC     | ERJ-6ENF5900V         |
| R4  | 120K                 | RES FILM SMD 0805              | MULTICOMP     | MC 0.1W 0805 1% 120K. |
| R46,R47,R63   | 49.9                 | RES PREC THICK FILM CHIP       | PANASONIC     | ERJ-6ENF49R9V         |



| Name                       | Value                           | Description                        | Manufacturer              | Manufacturer Part #     |
|----------------------------|---------------------------------|------------------------------------|---------------------------|-------------------------|
|                            |                                 | R0805                              |                           |                         |
| R54,R55                    | 33                              | RES FILM SMD 0805                  | PANASONIC                 | ERJ-6GEYJ33             |
| R59,R61,R86,R88            | TBD0603                         | DO NOT INSTALL                     | TBD0603                   | TBD0603                 |
| R64,R65,R82,R83            | 100                             | RES FILM SMD 0402                  | VENKEL                    | CR0402-16W-1000FPT      |
| R73                        | 1M                              | RES PREC THICK FILM CHIP<br>R0805  | PANASONIC                 | ERJ-6ENF1004V           |
| R94,R95                    | 60.4                            | RES PREC THICK FILM CHIP<br>R0805  | PANASONIC                 | ERJ-6ENF60R4V           |
| T1                         | T1-1T-<br>KK81+                 | XFMR RF                            | MINI CIRCUITS             | T1-1T-KK81+             |
| TP1                        | 0319-0-15-<br>15-18-27-<br>04-0 | CONN-PCB PIN<br>RECEPTACLE         | MILL-MAX                  | 0319-0-15-15-18-27-04-0 |
| TP7,TP8,TP16,TP24-<br>TP26 | BLK                             | CONN-PCB TST PNT BLK               | COMPONENTS_CORPORATION    | TP-104-01-00            |
| U1                         | EP3C5F256<br>C7N                | IC CYCLONE III FINELINE<br>BGA     | ALTERA                    | EP3C5F256C7N            |
| U7-U9,U11                  | ADP1708AR<br>DZ-R7              | IC-ADI LOW DROPOUT<br>CMOS LIN REG | ADI                       | ADP1708ARDZ-R7          |
| U13, U14                   | ULTRA LOW<br>DISTORTION<br>""   | IC-ADI UNITY GAIN<br>STABLE        | U13,U14                   | ADA4899-1YRDZ           |
| U4                         | EPCS4SI8N                       | IC SERIAL CONFIG DEVICE            | ALTERA                    | EPCS4SI8N               |
| U5                         | ADA4932-<br>1ACPZ-R7            | DIFF ADC DRIVER                    | ADI                       | ADA4938-1ACPZ-R7        |
| Y1                         | 100MHZ                          | IC CRYSTAL OSC                     | C-MAC                     | SPX0009437-CFPS-73      |
| TP2,TP3                    | 5015                            | CONN-PCB SMT TEST<br>POINTS        | KEYSTONE ELECTRONICS CORP | 5015                    |

**ORDERING GUIDE**

| <b>Evaluation Board Model</b> | <b>Product</b>    |
|-------------------------------|-------------------|
| EVAL-AD7625EDZ                | AD7625BCPZ        |
| EVAL-AD7626EDZ                | AD7626BCPZ        |
| EVAL-CED1Z                    | USB Capture Board |