



Chipsmall Limited consists of a professional team with an average of over 10 year of expertise in the distribution of electronic components. Based in Hongkong, we have already established firm and mutual-benefit business relationships with customers from,Europe,America and south Asia,supplying obsolete and hard-to-find components to meet their specific needs.

With the principle of "Quality Parts,Customers Priority,Honest Operation,and Considerate Service",our business mainly focus on the distribution of electronic components. Line cards we deal with include Microchip,ALPS,ROHM,Xilinx,Pulse,ON,Everlight and Freescale. Main products comprise IC,Modules,Potentiometer,IC Socket,Relay,Connector.Our parts cover such applications as commercial,industrial, and automotives areas.

We are looking forward to setting up business relationship with you and hope to provide you with the best service and solution. Let us make a better world for our industry!



Contact us

Tel: +86-755-8981 8866 Fax: +86-755-8427 6832

Email & Skype: info@chipsmall.com Web: www.chipsmall.com

Address: A1208, Overseas Decoration Building, #122 Zhenhua RD., Futian, Shenzhen, China





**ANALOG
DEVICES**

Evaluation Board for the AD7705/06 3V / 5V, 450 μ A, 2/3-Channel 16-Bit, Sigma Delta ADC

EVAL-AD7705EB/EVAL-AD7706EB

FEATURES

- Full-Featured Evaluation Board for the AD7705/06
- On-Board Reference and Digital Buffers
- Various Linking Options
- PC Software for Control of AD7705/06
- On-Board Patchwork Area

INTRODUCTION

This Technical Note describes the evaluation board for the AD7705/06, 450 μ A, 2/3-Channel 16-Bit, Sigma Delta ADCs. The AD7705/06 are complete analog front end for low frequency measurement applications. These 2/3-channel devices can accept low level input signals directly from a transducer and produce a serial digital output. They employ a sigma-delta conversion technique to realize up to 16 bits of no missing codes performance. The selected input signal is applied to a proprietary programmable gain front end based around an analog modulator. The modulator output is processed by an on-chip digital filter. The first notch of this digital filter can be programmed via an on-chip control register allowing adjustment of the filter cutoff and output update rate. Full data on the AD7705/06 is available in the AD7705/06 datasheet available from Analog Devices and should be consulted in conjunction with this Technical Note when using the evaluation board.

The evaluation board interfaces to the parallel port of an IBM compatible PC. Software is available with the

evaluation board which allows the user to easily program the AD7705/06.

Other components on the AD7705/06 Evaluation Board include an AD780 (a precision 2.5V reference), an AD589 (a 1.23V precision bandgap reference), a 4.9152 MHz crystal and digital buffers to buffer signals to and from the PC.

OPERATING THE AD7705/06 EVALUATION BOARD

Power Supplies

This evaluation board has two analog power supply inputs: AV_{DD} and AGND. An external +5V or +3V must be applied between these inputs which is used to provide the V_{DD} for the AD7705/06 and the reference. DGND and DV_{DD} connections are also available. The DV_{DD} is used to provide the DV_{DD} for the digital circuitry. DGND and AGND are connected together at the AD7705/06 GND pin. Therefore, it is recommended not to connect AGND and DGND elsewhere in the system.

All power supplies are decoupled to their respective grounds. DV_{DD} is decoupled using a 10 μ F tantalum capacitor and 0.1 μ F ceramic capacitor at the input to the evaluation board. It is again decoupled using 0.1 μ F capacitors as close as possible to each logic device. AV_{DD} is decoupled using a 10 μ F tantalum capacitor and 0.1 μ F ceramic capacitor as close as possible to the AD7705/06 and also at the reference.

Figure 1: Evaluation Board Setup

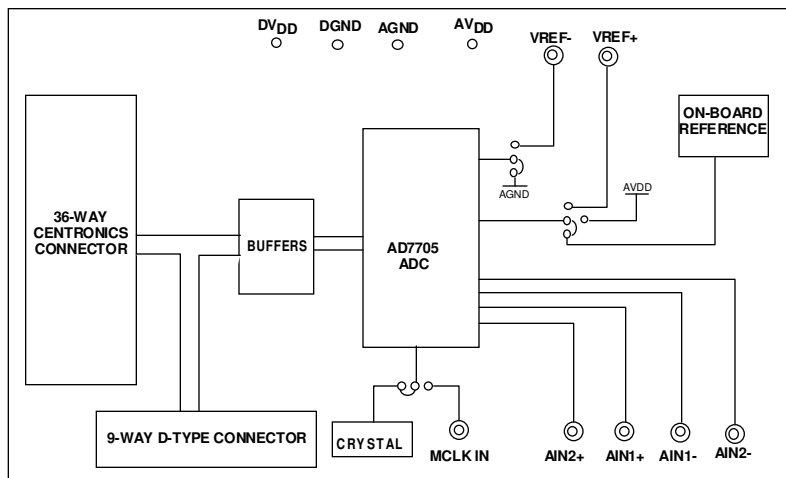

Information furnished by Analog Devices is believed to be accurate and reliable. However, no responsibility is assumed by Analog Devices for its use; nor for any infringements of patents or other rights of third parties which may result from its use. No license is granted by implication or otherwise under any patent or patent rights of Analog Devices.

One Technology Way; P.O. BOX 9106; Norwood, MA 02062-9106 U.S.A.
Tel: 617/329-4700 Twx: 710/394-6577
Telex: 174059 Cables: ANALOG NORWOOD MASS

EVAL-AD7705EB/EVAL-AD7706EB

LINK AND SWITCH OPTIONS

There are eight link options which must be set for the required operating setup before using the evaluation board. The functions of these link options are outlined below.

Link No. Function

- LK1** This option selects the master clock source for the AD7705/06. The master clock is generated by the on-board crystal or from an external source via SKT11. This is a double link and both links must be moved together for the correct operation of the evaluation board.
- With both links in position "A", the external clock option is selected and an external clock applied to SKT11 is routed to the MCLKIN pin of the AD7705/06.
- With both links in position "B", the on-board crystal is selected to provide the master clock to the AD7705/06.
- LK2** This link is used to select the on-board reference.
- With this link in position "A", the AD780 is selected as the on-board reference. This provides a 2.5V reference which is suitable for the AD7705/06 operating at +5V.
- With this link in position "B", the AD589 is selected as the on-board reference. This provides a 1.23V reference which is suitable for the AD7705/06 operating at +3V.
- LK3** This link is used to select the reference source for the REFIN(-) input of the AD7705/06.
- With LK3 in position "A", the REFIN(-) pin is connected to SKT10. An external voltage applied to SKT10 can now be used as the REFIN(-) for the AD7705/06.
- With LK3 in position "B", the REFIN(-) pin is connected directly to AGND.
- LK4** This link is used to select the reference source for the REFIN(+) input of the AD7705/06.
- With LK5 in position "A", the REFIN(+) pin is connected to the output of the on-board reference.
- With LK5 in position "B", the REFIN(+) pin is connected directly to AV_{DD}.
- With LK5 in position "C", the REFIN(+) pin is connected to SKT9. An external voltage applied to SKT9 can now be used as the REFIN(+) for the AD7705/06.
- LK5** This link is in series with the AIN1+/(AIN2) input of the AD7705/(06).
- With this link in place, an analog input signal applied to SKT3 is routed directly to the AIN1+/(AIN2) pin of the AD7705/(06).
- This link may be removed so that the analog input signal at SKT3 can be connected to the user patchwork area for signal conditioning before being applied to the AD7705/06.
- LK6** This link is in series with the AIN1-(COMMON) input of the AD7705/(06).
- With this link in place, an analog input signal applied to SKT4 is routed directly to the AIN1-(COMMON) pin of the AD7705/(06).
- This link may be removed so that the analog input signal at SKT4 can be connected to the user patchwork area for signal conditioning before being applied to the AD7705/06.
- LK7** This link is in series with the AIN2+/(AIN1) input of the AD7705/(06).
- With this link in place, an analog input signal applied to SKT5 is routed directly to the AIN2+/(AIN1) pin of the AD7705/(06).
- This link may be removed so that the analog input signal at SKT5 can be connected to the user patchwork area for signal conditioning before being applied to the AD7705/06.
- LK8** This link is in series with the AIN2-(AIN3) input of the AD7705/(06).
- With this link in place, an analog input signal applied to SKT6 is routed directly to the AIN2-(AIN3) pin of the AD7705/(06).
- This link may be removed so that the analog input signal at SKT6 can be connected to the user patchwork area for signal conditioning before being applied to the AD7705/06.

EVAL-AD7705EB/EVAL-AD7706EB

SET-UP CONDITIONS

Care should be taken before applying power and signals to the evaluation board to ensure that all link positions are as per the required operating mode. Table 1 shows the position in which all the links are set when the evaluation board is sent out.

Table 1: Initial Link and Switch Positions

Link No. Position Function

LK1	B+B	Both links in position "B" to select the on-board crystal as the master clock for the AD7705/06.
LK2	A	This selects +2.5V as the on-board reference.
LK3	A	This connects the REFIN(-) input of the AD7705/06 to AGND.
LK4	A	The on-board reference provides the reference voltage for the REFIN(+) input of the AD7705/06.
LK5	IN	The AIN1+ pin on the AD7705/06 is tied to the analog input sockets SKT3.
LK6	IN	The AIN1- pin on the AD7705/06 is tied to the analog input sockets SKT4.
LK7	IN	The AIN2+ pin on the AD7705/06 is tied to the analog input sockets SKT5.
LK8	IN	The AIN2- pin on the AD7705/06 is tied to the analog input sockets SKT6.

EVALUATION BOARD INTERFACING

Interfacing to the evaluation board is via either a 9-way d-type connector, SKT1 or a 36-way centronics connector, SKT2. The pin-out for the SKT1 connector is shown in Fig. 2 and its pin designations are given in Table 2. The pin-out for the SKT2 connector is shown in Fig. 3 and its pin designations are given in Table 3.

SKT2 is used to connect the evaluation board to the parallel (printer) port of a PC. Connection is via a standard printer cable. SKT1 is used to connect the evaluation to any other system. The evaluation board should be powered up before a cable is connected to either of these connectors.

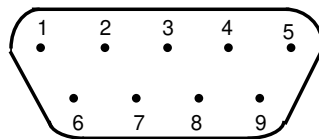

Fig. 2: Pin Configuration for the 9-Way D-Type Connector, SKT1.

Table 2.: SKT1 Pin Description ¹

1	SCLK	Serial Clock. The signal on this pin is buffered before being applied to the SCLK pin of the AD7705/06.
2	DRDY	Logic output. This is a buffered version of the signal on the AD7705/06 DRDY pin
3	CS	Chip Select. The signal on this pin is buffered before being applied to the CS pin on the AD7705/06.
4	RESET	Reset Input. Data applied to this pin is buffered before being applied to the AD7705/06 RESET pin.
5	DIN	Serial Data Input. Data applied to this pin is buffered before being applied to the AD7705/06 DIN pin.
6	DGND	Ground reference point for the digital circuitry. Connects to the DGND plane on the Evaluation board.
7	DOUT	Serial Data Output. This is a buffered version of the signal on the AD7705/06 DOUT pin.
8	DV _{DD}	Digital Supply Voltage. If no voltage is applied to the board's DV _{DD} input terminal then the voltage applied to this pin will supply the DV _{DD} for the digital buffers.
9	NC	Not Connected.

Note

¹ An explanation of the AD7705/06 functions mentioned here is given in Table 3 overleaf as part of the SKT2 pin descriptions.

EVAL-AD7705EB/EVAL-AD7706EB

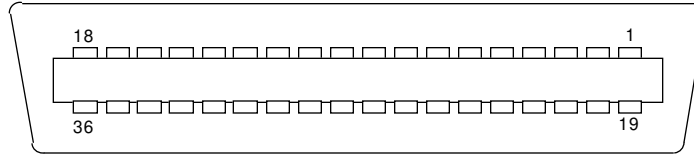

Fig. 3: 36-way Centronics (SKT2) Pin Configuration

Table 3: 36-Way Connector Pin Description

1	NC	No Connect. This pin is not connected on the evaluation board.
2	DIN	Serial Data Input. Data applied to this pin is buffered before being applied to the AD7705/06 DIN pin. Serial Data Input with serial data being written to the input shift register on the part. Data from this input shift register is transferred to the setup register, clock register or communications register depending on the register selection bits of the Communications Register.
3	<u>RESET</u>	Reset Input. The signal on this pin is buffered before being applied to the <u>RESET</u> pin of the AD7705/06. <u>RESET</u> is an active low input which resets the control logic, interface logic, calibration coefficients, digital filter and analog modulator of the part to power-on status.
4	<u>CS</u>	Chip Select. The signal on this pin is buffered before being applied to the <u>CS</u> pin of the AD7705/06. <u>CS</u> is an active low Logic Input used to select the AD7705/06. With this input hard-wired low, the AD7705/06 can operate in its three-wire interface mode with SCLK, DIN and DOUT used to interface to the device. <u>CS</u> can be used to select the device in systems with more than one device on the serial bus or as a frame synchronization signal in communicating with the AD7705/06.
5	SCLK	Serial Clock. The signal on this pin is buffered before being applied to the SCLK pin of the AD7705/06. An external serial clock is applied to this input to read/write serial data from/to the AD7705/06. This serial clock can be continuous with all data transmitted in a continuous train of pulses. Alternatively, it can be non-continuous with the information being transmitted to the AD7705/06 in smaller batches of data.
6-8	NC	No Connect. These pins are not connected on the evaluation board.
9	DV _{DD}	Digital Supply Voltage. This provides the supply voltage for the buffer chips, U3-U5, which buffer the signals between the AD7705/06 and SKT1/SKT2.
10	<u>DRDY</u>	Logic output. This is a buffered version of the signal on the AD7705/06 <u>DRDY</u> pin. A logic low on this output indicates that a new output word is available from the AD7705/06 data register. The <u>DRDY</u> pin will return high upon completion of a read operation of a full output word. If no data read has taken place between output updates, the <u>DRDY</u> line will return high for 500 x CLK _{IN} cycles prior to the next output update. While <u>DRDY</u> is high, a read operation should not be attempted to avoid reading from the data register as it is being updated. The <u>DRDY</u> line will return low again when the update has taken place. <u>DRDY</u> is also used to indicate when the AD770-55 has completed its on-chip calibration sequence.
11-12	NC	No Connect. These pins are not connected on the evaluation board.
13	DOUT	Serial Data Output. This is a buffered version of the signal on the AD7705/06 DOUT pin. Serial Data Output with serial data obtained from the output shift register on the AD7705/06. The output shift register can contain information from the setup register, communications register, clock register or data register depending on the register selection bits of the Communications Register.
14-18	NC	No Connect. These pins are not connected on the evaluation board.
19-30	DGND	Ground reference point for digital circuitry. Connects to the DGND plane on the evaluation board.
31-36	NC	No Connect. These pins are not connected on the evaluation board.

EVAL-AD7705EB/EVAL-AD7706EB

SOCKETS

There are nine sockets relevant to the operation of the AD7705/06 on this evaluation board. The functions of these sockets are outlined in Table 4.

Table 4. Socket Functions

Socket	Function
SKT1	9-way D-Type connector used to interface to other systems.
SKT2	36-way centronics connector used to interface to PC via parallel printer port.
SKT3	Sub-Miniature BNC (SMB) Connector. The analog input signal for the AIN1+(AIN2) input of the AD7705/(06) is applied to this socket.
SKT4	Sub-Miniature BNC (SMB) Connector. The analog input signal for the AIN1-(COMMON) input of the AD7705/(06) is applied to this socket.
SKT5	Sub-Miniature BNC (SMB) Connector. The analog input signal for the AIN2+(AIN1) input of the AD7705/(06) is applied to this socket.
SKT6	Sub-Miniature BNC (SMB) Connector. The analog input signal for the AIN2-(AIN3) input of the AD7705/(06) is applied to this socket.
SKT9	Sub-Miniature BNC (SMB) Connector. The reference voltage for the REFIN- input of the AD7705/06 is applied to this socket when the board is configured for an externally applied reference voltage.
SKT10	Sub-Miniature BNC (SMB) Connector. The reference voltage for the REFIN+ input of the AD7705/06 is applied to this socket when the board is configured for an externally applied reference voltage.
SKT11	Sub-Miniature BNC (SMB) Connector. The master clock signal for the MCLKIN input of the AD7705/06 is applied to this socket when the board is configured for an externally applied master clock. The AD7705/06 can be operated with internal clock frequencies in the range 500kHz to 5MHz.

CONNECTORS

There are two connectors on the AD7705/06 evaluation board as outlined in Table 5.

Table 5. Connector Functions

Connector Functions

J1	PCB Mounting Terminal Block. The Digital Power Supply to the Evaluation Board is provided via this Connector if it is not being supplied via SKT1 or SKT2.
J2	PCB Mounting Terminal Block. The Analog Power Supply to the Evaluation Board must be provided via this Connector.

SWITCHES

There is one switch on the AD7705/06 Evaluation board. SW1 is a push-button reset switch. Pushing this switch activates the active low RESET input on the AD7705/06 which resets the control logic, interface logic, calibration coefficients, digital filter and analog modulator of the part to power-on status.

EVAL-AD7705EB/EVAL-AD7706EB

AD7705 SOFTWARE DESCRIPTION

The AD7705/06 evaluation board is shipped with a 3½" disk containing software that can be installed onto a standard PC to control the AD7705/06.

The software uses the printer port of the PC to communicate with the AD7705/06, so a Centronics printer cable is used to connect the PC to the evaluation board.

Software Requirements and Installation

The software runs under Windows 3.1™ or Windows 95™ and typically requires 4Mb of RAM.

To install the software the user should start Windows and use either File Manager (in Windows 3.1) or Windows Explorer (in Windows 95) to locate the file called SETUP.EXE on the floppy disk. Double clicking on this file will start the installation procedure. The user is prompted for a destination directory which is "C:\AD7705" by default. Once the directory has been selected the installation procedure will copy the files into the relevant directories on the hard drive. The installation program will create a Program Group called "Analog Devices" on the desktop for Windows 3.1 or in the "Start" taskbar for Windows95. Once the installation procedure is complete the user can double click on the AD7705 icon to start the program.

Features of the Software

1. The software will allow the user to write to and read from all the registers of the AD7705.
2. Data can be read from the AD7705 and displayed or stored for later analysis.
3. The data that has been read can be exported to other packages such as Mathcad or Excel for further analysis.

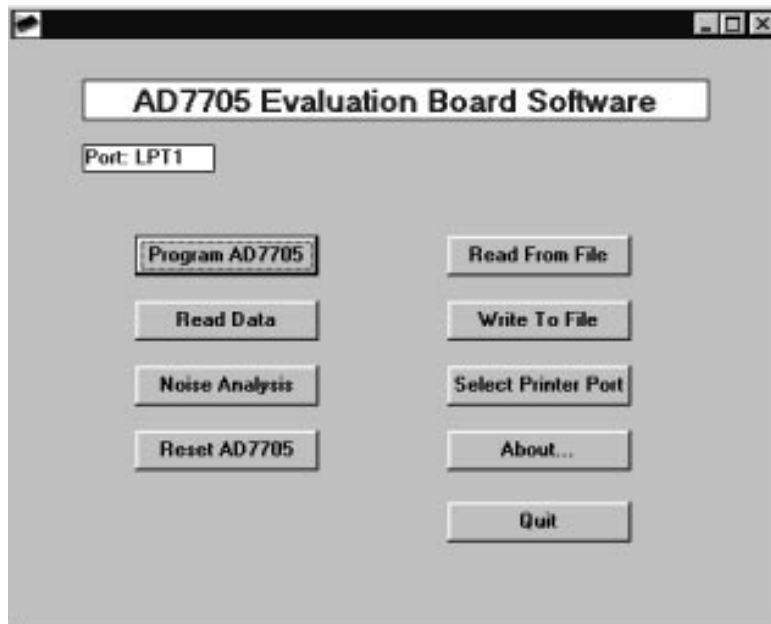

Fig. 4. The Main Screen

EVAL-AD7705EB/EVAL-AD7706EB

What follows is a description of the various windows that appear while the software is being used. Fig. 4. shows the main screen that appears once the program has started. The printer port that will be used by the software is shown in the top left of the screen. There are three possible printer ports that can be handled by the software, LPT1 (standard), LPT2 and PRN. In the event that the PC has two printer ports the software will always select the one which is set as default by the PC. The user can change to the other printer port by using the "Select Printer Port" button on the main screen. A brief description of each of the buttons on the main screen follows:

Program	AD7705	Allows the user to program the selected register for a specific channel of the AD7705.
Read	Data	Allows the user to read a number of samples from the AD7705. These samples can be stored for further analysis or just displayed for reference.
Noise	Analysis	Allows the user to perform noise analysis on the data that has been read in.
Reset	AD7705	Allows the user to perform a reset on the AD7705.
Read	From File	Allows the user to read in previously stored data for display or analysis.
Write	To File	Allows the user to write the current set of data to a file for later use.
Select	Printer Port	Allows the user to change which printer port the software uses (only valid for PCs with more than one printer port).
About		Provides information about the version of software being used.
Quit		Ends the program

The Program AD7705 Screen

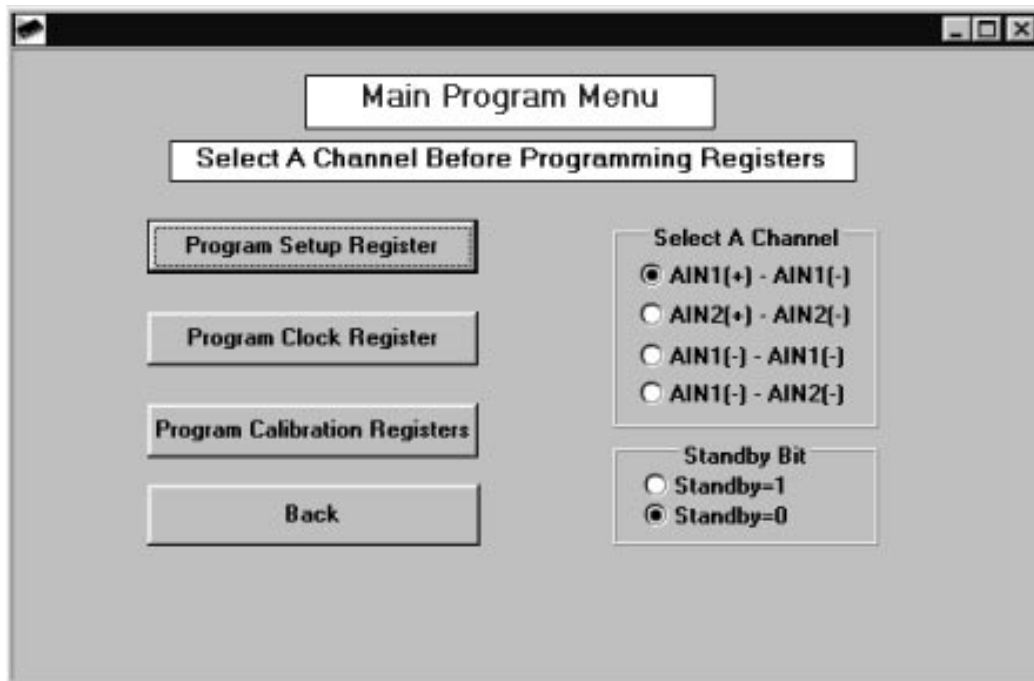

Fig. 5. The Program AD7705 Screen

EVAL-AD7705EB/EVAL-AD7706EB

Fig. 5. shows the screen that appears when the Program AD7705 button is selected. This screen allows the user to select which register is to be programmed. Before selecting any of the buttons on this screen the user should first choose the channel that is to be used for all the subsequent operations. The state of the Standby bit should also be selected here.

The Setup Register Screen

Fig. 6. shows the Setup Register screen. When the screen is loaded the software will read the current contents from the Setup Register of the AD7705 and change the option buttons accordingly. The setup register is used to change the operating mode of the AD7705, change the gain setting, set the part to bipolar or unipolar mode, set the part to buffered or unbuffered mode and select the state of the FSYNC bit. Every time a change is made the software will write the new conditions to the AD7705 and read back the setup register for confirmation.

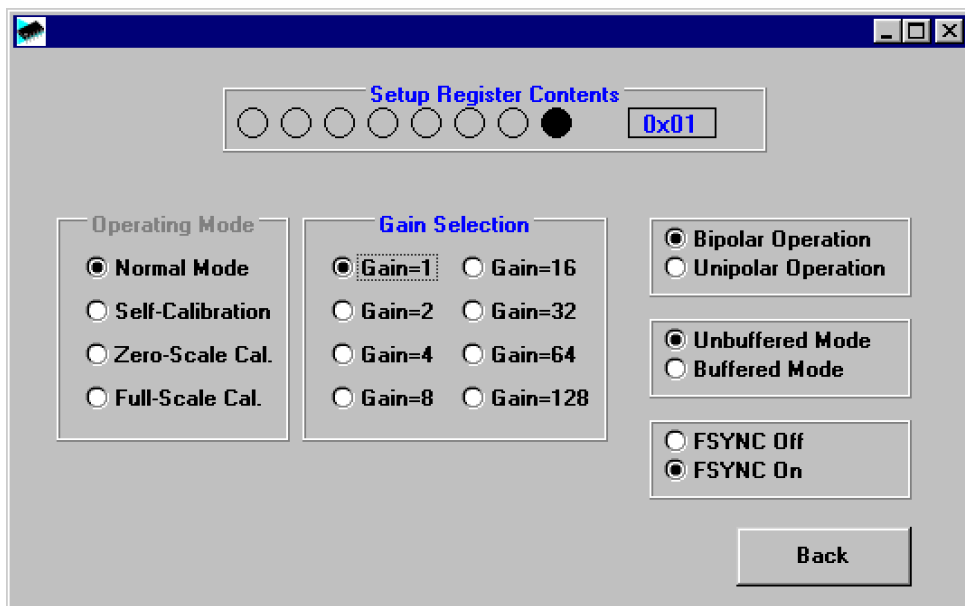

Fig. 6. The Setup Screen

When the user selects a calibration, the software will start the calibration by writing to the AD7705 and then monitor the DRDY. A falling edge of the DRDY pin will indicate that the calibration has been completed. After a calibration the AD7705 returns to its normal operating mode and the program updates the screen to indicate this. The default status for the setup register on power-up is 01 (hex).

The Clock Register Screen

Fig. 7. shows the Clock Register setup screen. The Clock Register is used to control the output update rate of the AD7705. The CLKDIS bit is used to control the operation of the MCLKOUT pin.

A logic 0 in this bit allows the AD7705 to function in its normal operating mode when a crystal oscillator is used as the clock source.

A logic 1 disables the MCLKOUT from appearing at the pin. When disabled the MCLKOUT pin is forced low. If the AD7705 is using a crystal oscillator as the clock then disabling the MCLKOUT will stop the clock and no conversions will be done by the AD7705. The user should consult the datasheet for more information on the use of the CLKDIS bit.

EVAL-AD7705EB/EVAL-AD7706EB

The CLKDIV is used to set the internal operating frequency of the AD7705. The user should consult the datasheet for more information on the use of the CLKDIV bit.

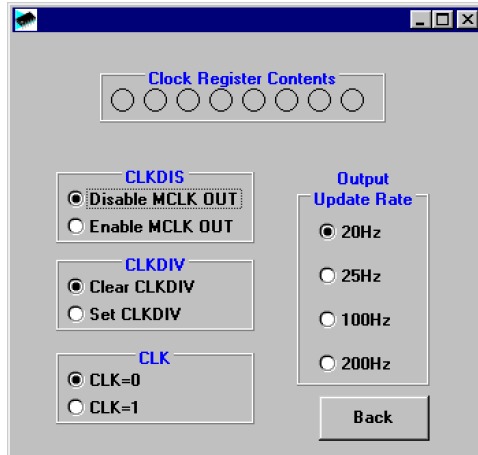

Fig. 7. The Clock Register Screen

The CLK bit is used in conjunction with the Output Update Rate buttons to select the output update rate.

If the AD7705 is being operated with a clock of 4.9152MHz (CLKDIV=1) or 2.4576MHz (CLKDIV=0) then this bit should be set to a 1 giving a choice of 50Hz, 60Hz, 250Hz or 500Hz as an output update rate.

If the AD7705 is being operated with a clock of 2MHz (CLKDIV=1) or 1MHz (CLKDIV=0) then this bit should be set to a 0 giving a choice of 20Hz, 25Hz, 100Hz or 200Hz as an output update rate.

The Power-On/Reset status of this register is 05 hex.

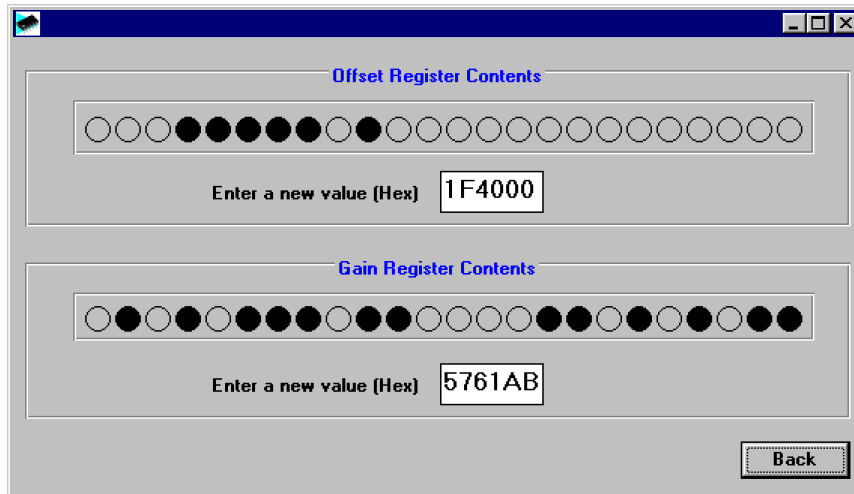

Fig. 7. The Calibration Registers Screen

EVAL-AD7705EB/EVAL-AD7706EB

The Calibration Registers Screen

Fig. 8. shows the Calibration Registers screen. When this screen is displayed the values of the Gain and Offset Registers are read from the AD7705 and displayed. The user has the ability to change the values of either register if required. the default value for the fullscale cal register is 5761AB hex and the default value for the zero scale cal register is 1F4000 hex.

The Read Data Screen

Fig. 9. shows the Read Data screen. This is where the user can read a number of samples from the AD7705. The user has the option of either reading data for analysis or display.

When the Read For Analysis button is selected the software will read the required number of samples from the AD7705 and store them in an array so that they can be graphed or analysed later. It is possible to read upto 5000 samples at any one time although only 3000 can be displayed on a graph.

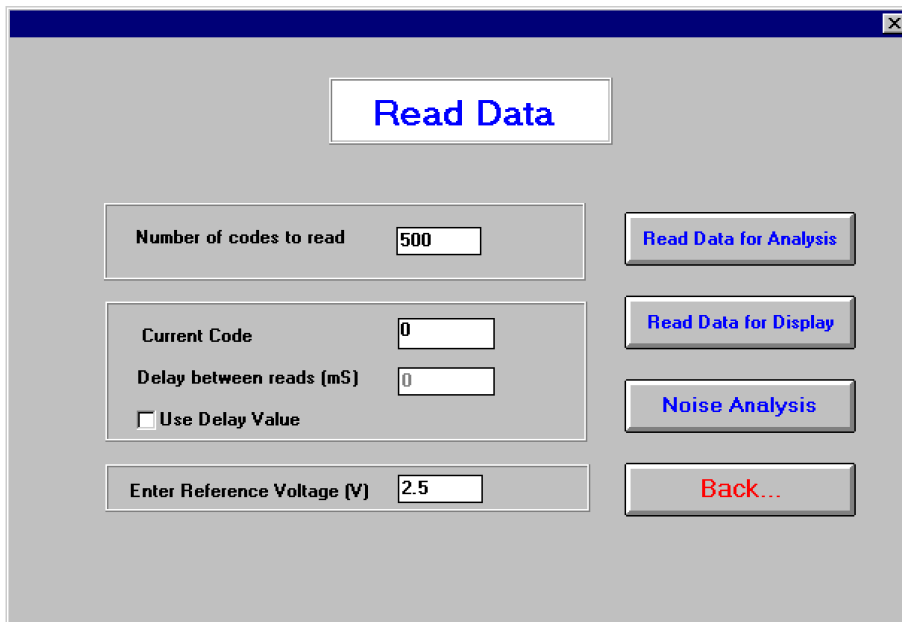

Fig. 9. The Read Data Screen

When the Read for Display button is selected the software will read one sample from the AD7705 and display its value in the Current Code text box. The software will continue to read and display the samples until a key has been pressed. It is possible to add a delay to the read cycle by checking the Use Delay Value checkbox. If the box is checked the software will wait the required number of milliseconds between reading samples. It should be noted however that the accuracy of the time delay can be affected by other programs running under Windows, therefore this method is not suitable where equidistant sampling is required.

The Noise Analysis Screen

Once data has been read from the AD7705 it is possible to perform some analysis on it. Fig. 10. shows the Noise Analysis Screen. This screen displays the maximum and minimum codes read from the AD7705 (in decimal and hexadecimal), as well as the average code, the average voltage and the RMS and Peak-Peak noise values. From this screen it is possible to display the data on a graph or as a histogram of codes. Figures 11 and 12 show the Graph and Histogram screens.

EVAL-AD7705EB/EVAL-AD7706EB

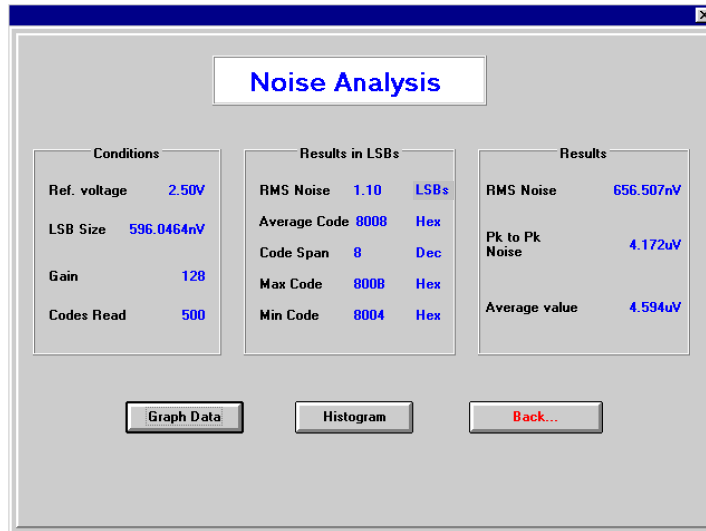

Fig. 10. The Noise Analysis Screen

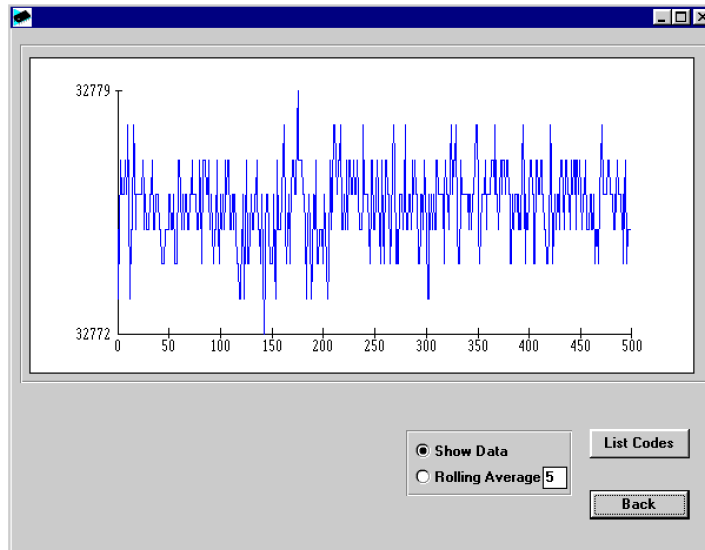

Fig. 11. The Graph Screen

The Graph Screen

This screen displays the data in graph format. A rolling average feature is available by selecting the rolling average button. By default this is a 5 point rolling average but this can be changed to any integer between 1-99. The list codes button allows the user to view all the codes and the number of occurrences of these codes.

EVAL-AD7705EB/EVAL-AD7706EB

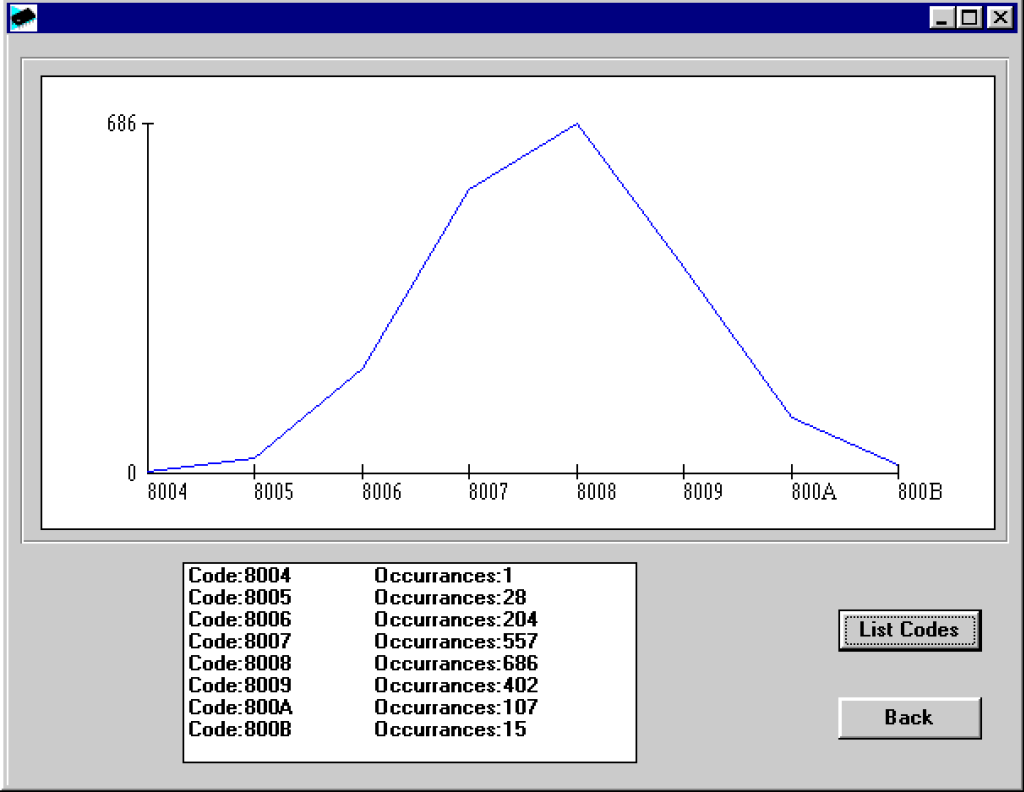

Fig. 12. The Histogram Screen

EVAL-AD7705EB/EVAL-AD7706EB

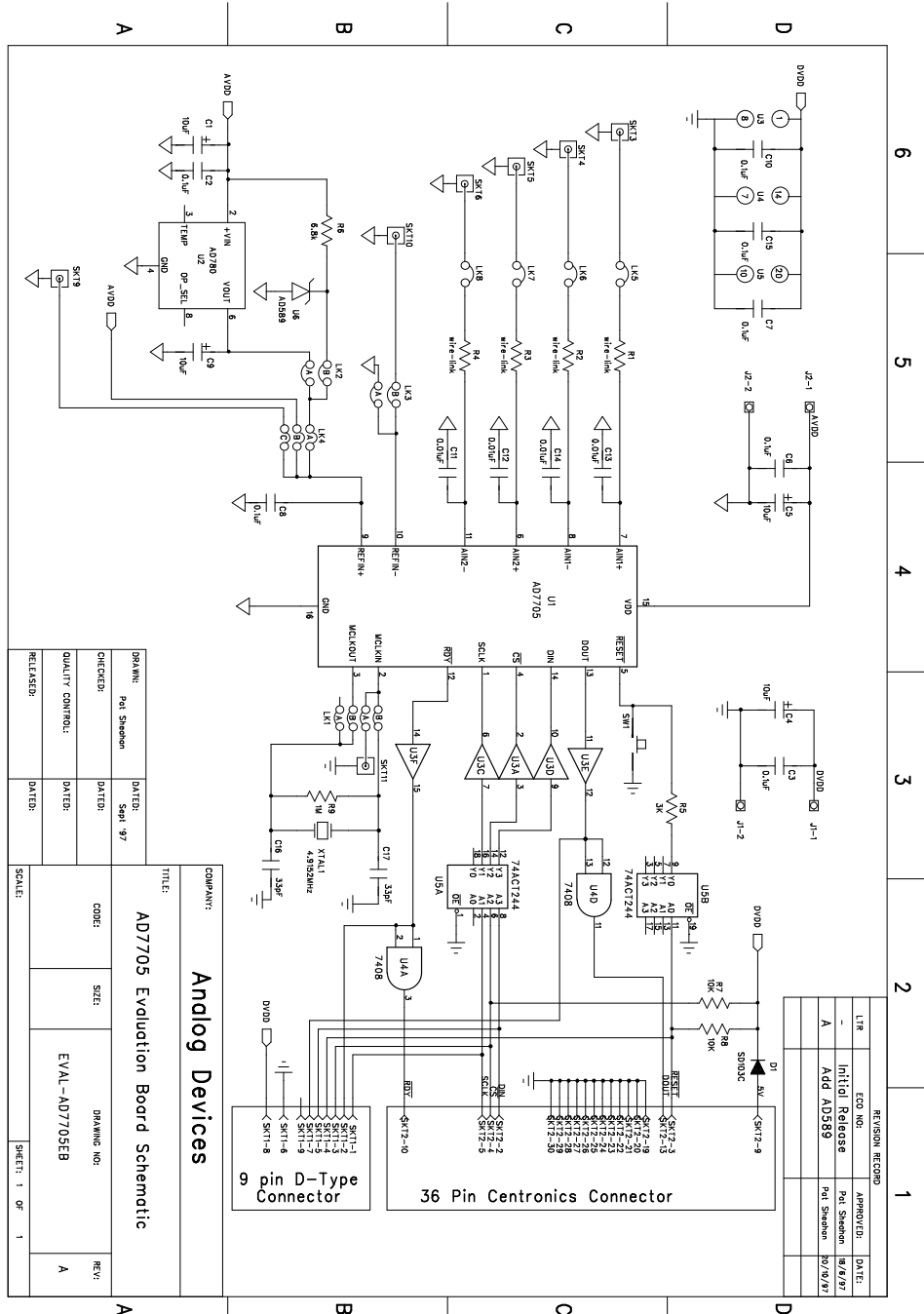

Fig. 13. The Evaluation Board Schematic

EVAL-AD7705EB/EVAL-AD7706EB

Table 6. Component Listing and Manufacturers

INTEGRATED CIRCUITS

Component	Location	Vendor
AD7705AN/AD7706AN	U 1	Analog Devices
AD780AN	U 2	Analog Devices
74HC4050N	U 3	Philips
74C08N	U 4	Texas Instruments
74HC244N	U 5	Texas Instruments
AD589LH	U 6	Analog Devices
SD103C	D 1	ITT

CAPACITORS

Component	Location	Vendor
10 μ F \pm 20% Tantalum (16 V)	C1 C4 C5 C9	AVX- Kyocera Mftrs No. TAG106MO16
0.1 μ F Ceramic(X7R \pm 20%)	C2 C3 C6 C7 C8 C10 C15	Philips Mftrs No. CW20C 104M
0.01 μ F NP0	C11 C12 C13 C14	AVX-Kyocera Mftrs No. SR20X7R
33pF \pm 2% Ceramic	C16 C17	Philips Mftrs No. 683 34339

RESISTORS

Component	Location	Vendor
Short Circuits	R1 R2 R3 R4	-----
3k Ω \pm 5% 0.25W Carbon Film	R 5	Bourns 3k Ω \pm 5% 0.25W
6.8k Ω \pm 5% 0.25W Carbon Film	R 6	Bourns 6.8k Ω \pm 5% 0.25W
10k Ω \pm 5% 0.25W Carbon Film	R7 R8	Bourns 10k Ω \pm 5% 0.25W
1M Ω \pm 5% 0.25W Carbon Film	R 9	Bourns 1M Ω \pm 5% 0.25W

LINK OPTIONS

Component	Location	Vendor
Pin Headers	Lk1 (4x2 way) Lk2 Lk3 (2x2 way) Lk4 (3x2 way) Lk5,Lk6,Lk7,Lk8 (1x2 way)	Harwin Mftrs No. M20-9993606
Shorting Plugs	Pin Headers (9 required)	Harwin Mftrs No. M7571-05

SWITCH

Component	Location	Vendor
Sealed Push Button Switch	SW1	Omron Mftrs No. B3W1000

EVAL-AD7705EB/EVAL-AD7706EB

SOCKETS

Component	Location	Vendor
Miniature BNC Connectors	SKT3-SKT6, SKT9 - SKT11	M/A - Com Greenpar Mftrs No. B65N07G999X99
9-Way D-Type Connector	SKT1	McMurdo Mftrs No. SDE9PNTD
36 Way Centronics Connector	SKT 2	Fujitsu Mftrs No. FCN785J036G0
2 Way Terminal Block	J1 J2	Bulgin RIA
Low profile socket	U1 - U5 (82 pins needed)	Harwin Farnell No. 519-959

CRYSTAL OSCILLATOR

Component Identification	Location	Vendor
4.9152 MHz Oscillator	Xtal 1	IQD Mftrs No. A127A

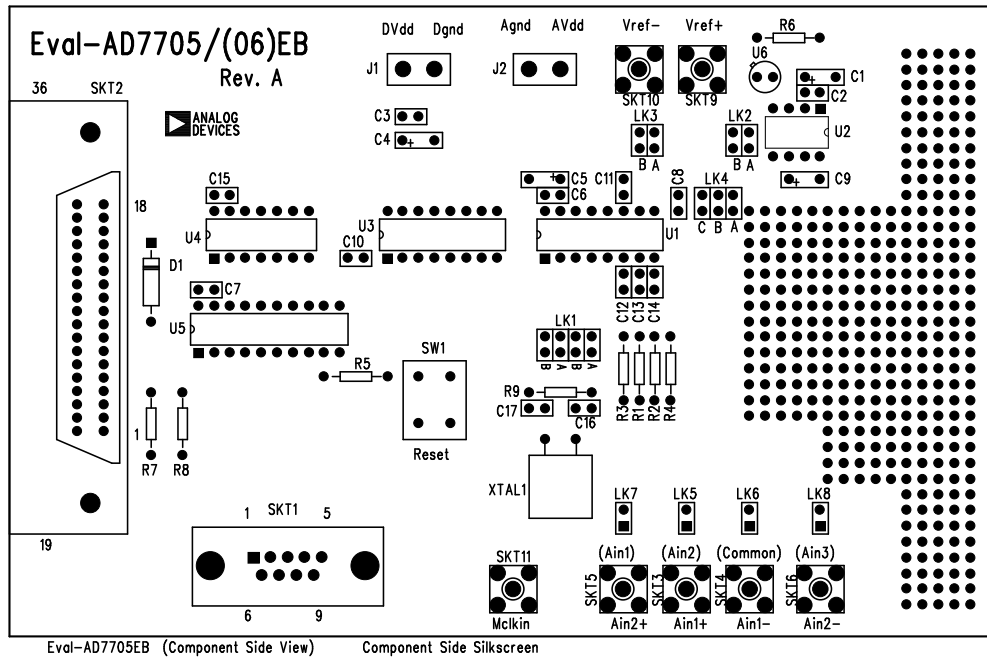

Fig. 14. The Evaluation Board Component Layout Diagram

EVAL-AD7705EB/EVAL-AD7706EB

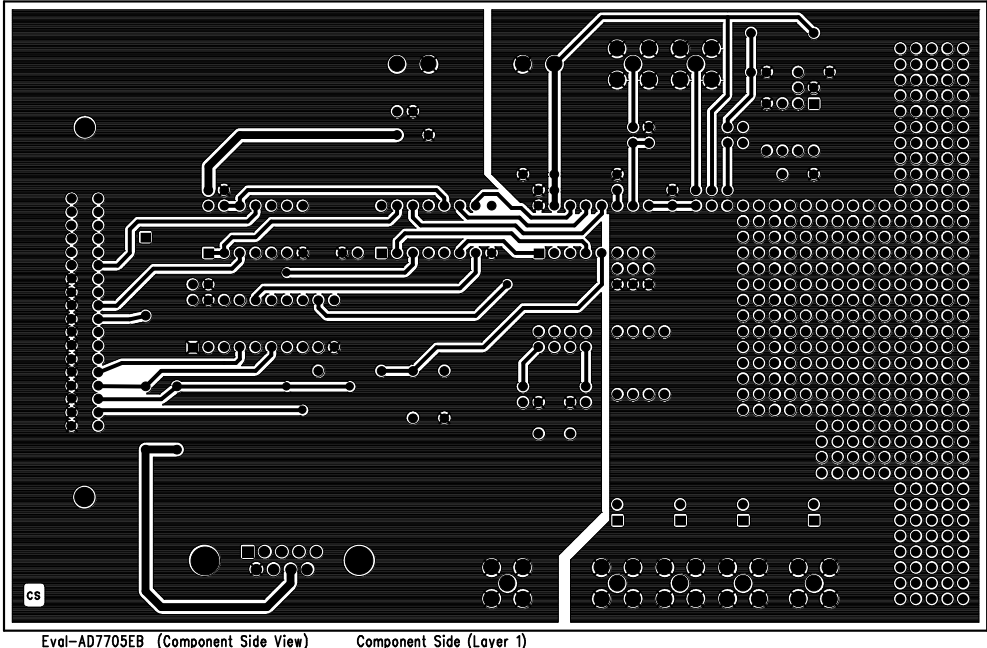

Fig. 15. The Evaluation Board Component Side Artwork.

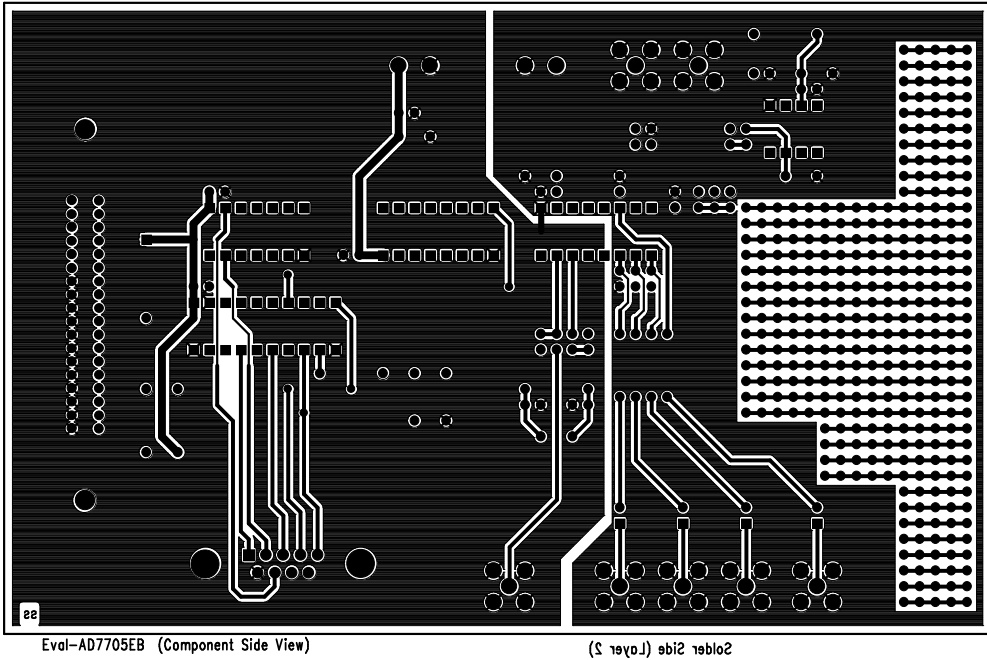

Fig. 16. The Evaluation Board Solder Side Artwork.