



Chipsmall Limited consists of a professional team with an average of over 10 year of expertise in the distribution of electronic components. Based in Hongkong, we have already established firm and mutual-benefit business relationships with customers from,Europe,America and south Asia,supplying obsolete and hard-to-find components to meet their specific needs.

With the principle of “Quality Parts,Customers Priority,Honest Operation,and Considerate Service”,our business mainly focus on the distribution of electronic components. Line cards we deal with include Microchip,ALPS,ROHM,Xilinx,Pulse,ON,Everlight and Freescale. Main products comprise IC,Modules,Potentiometer,IC Socket,Relay,Connector.Our parts cover such applications as commercial,industrial, and automotives areas.

We are looking forward to setting up business relationship with you and hope to provide you with the best service and solution. Let us make a better world for our industry!



Contact us

Tel: +86-755-8981 8866 Fax: +86-755-8427 6832

Email & Skype: info@chipsmall.com Web: www.chipsmall.com

Address: A1208, Overseas Decoration Building, #122 Zhenhua RD., Futian, Shenzhen, China





Evaluation Board for the AD7719, 16&24-Bit, Dual Sigma Delta ADC

EVAL-AD7719-EB

FEATURES

- Full-Featured Evaluation Board for the AD7719
- On-Board Reference and Digital Buffers
- Various Linking Options
- PC Software for Control of AD7719

INTRODUCTION

This Technical Note describes the evaluation board for the AD7719, Low Voltage, Low Power, 16&24-Bit, Dual Sigma Delta ADC. The AD7719 is a complete analog front end for low frequency measurement applications. The AD7719 is factory calibrated and therefore does not require field calibration. The device can accept low level input signals directly from a transducer and produce a serial digital output. It employs a sigma-delta conversion technique to realize up to 24 bits (Main ADC) or 16 bits (Auxiliary ADC) of no missing codes performance. The selected input signal is applied to a proprietary programmable gain (Main ADC only) front end based around an analog modulator. The modulator output is processed by an on-chip digital filter. The first notch of this digital filter can be programmed via an on-chip control register allowing adjustment of the filter cutoff and output update rate. Full data on the AD7719 is available in the AD7719 datasheet available from Analog Devices and should be consulted in conjunction with this Technical Note when using the evaluation board.

The evaluation board interfaces to the parallel port of an IBM compatible PC. Software is available with the evalu-

ation board which allows the user to easily program the AD7719.

Other components on the AD7719 Evaluation Board include two AD780s (precision 2.5V references), a 32.7680 kHz crystal and digital buffers to buffer signals to and from the PC.

OPERATING THE AD7719 EVAL BOARD

Power Supplies

This evaluation board has two analog power supply inputs: AV_{DD} and $AGND$. An external +5V must be applied between these inputs which is used to provide the V_{DD} for the AD7719 and the reference. Digital Power connections are also required through $DGND$ & DV_{DD} . The DV_{DD} is used to provide the DV_{DD} for the digital circuitry. $DGND$ and $AGND$ are connected together at the AD7719 GND pin. Therefore, it is recommended not to connect $AGND$ and $DGND$ elsewhere in the system.

All power supplies are decoupled to their respective grounds. DV_{DD} is decoupled using a 10 μ F tantalum capacitor and 0.1 μ F ceramic capacitor at the input to the evaluation board. It is again decoupled using 0.1 μ F capacitors as close as possible to each logic device. AV_{DD} is decoupled using a 10 μ F tantalum capacitor and 0.1 μ F ceramic capacitor as close as possible to the AD7719 and also at the reference.

Fig. 1. Evaluation Board
Set-up

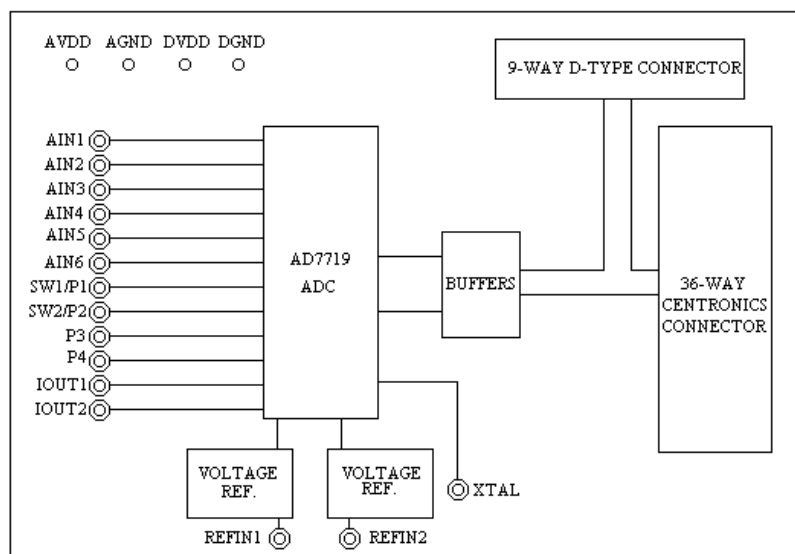

REV. B

Information furnished by Analog Devices is believed to be accurate and reliable. However, no responsibility is assumed by Analog Devices for its use, nor for any infringements of patents or other rights of third parties which may result from its use. No license is granted by implication or otherwise under any patent or patent rights of Analog Devices.

One Technology Way, P.O. Box 9106, Norwood, MA 02062-9106,
U.S.A.
Tel: 617/329-4700

Fax: 617/326-8703

EVAL-AD7719-EB

LINK AND SWITCH OPTIONS

There are fourteen link options which must be set for the required operating setup before using the evaluation board. The functions of these link options are outlined below.

Link No. Function

- LK1-LK6 These links are in series with the AIN1 through AIN6 analog inputs respectively.
With these links in place, the analog inputs on the relevant SKT input is connected directly to the respective AIN input on the part. For example, with LK1 in place, the analog input applied to SKT1 is connected directly to AIN1 of the AD7719.
- LK7&8 This option selects the master clock source for the AD7719. The master clock is generated by the on-board crystal or from an external source via SKT7. This is a double link and both links must be moved together for the correct operation of the evaluation board.
With both links in position "A", the external clock option is selected and an external clock applied to SKT7 is routed to the XTAL1 pin of the AD7719.
With both links in position "B", the on-board crystal is selected to provide the master clock to the AD7719.
- LK9 This link is used to select the reference source for the REFIN(-) input of the AD7719.
With this link in position "A", REFIN1(-) is connected directly to AGND.
With this link in position "B", the voltage generated across R10 (IOUT1*R10) is selected as the on-board reference for REFIN(+). LK10 should also be connected for this set-up to connect R10 and REFIN(-) to AGND. LK11 & LK12 should also be connected for this set-up to connect IOUT1 to R10.
With this link in position "C", the REFIN(-) pin is connected to SKT14. An external voltage applied to SKT14 can now be used as the REFIN(-) for the AD7719.
- LK10 This link is used to select the reference source for the REFIN(+) input of the AD7719.
With this link in position "A", REFIN1(+) is connected to the output of the on-board reference (AD780 - U6).
With this link in position "B", the REFIN1(+) pin is connected to SKT15. An external voltage applied to SKT15 can now be used as the REFIN(+) for the AD7719.
With this link in position "C", the REFIN(+) pin is connected to AVDD.
This link should be disconnected if using the voltage generated across R10, due to IOUT1.
- LK11 This link is used for selecting IOUT1*R10 as a reference voltage.
- LK12 This link is used for selecting IOUT1*R10 as a reference voltage.
- LK13 This link is used for selecting IOUT1*R10 as a reference voltage.
- LK14 This link selects the reference source for the REFIN2 input of the AD7719.
With this link in position "A", REFIN2 is connected to the output of the on-board reference (AD780 - U2).
With this link in position "B", the REFIN2 pin is connected to SKT16. An external voltage applied to SKT16 can now be used as the REFIN2 for the AD7719.

SET-UP CONDITIONS

Care should be taken before applying power and signals to the evaluation board to ensure that all link positions are as per the required operating mode. Table 1 shows the position in which all the links are set when the evaluation board is sent out.

Table 1: Initial Link and Switch Positions

Link No.	Position	Function
LK1-LK6	IN	Connects analog inputs from SKT1-SKT6 to the input pins AIN1-AIN6 of the AD7719.
LK7&LK8	B+B	Both links in position B to select the on-board crystal as the master clock for the AD7719.
LK9	A	This connects the REFIN1(-) input of the AD7719 to AGND.

LK10	A	The on-board reference (U6) provides the reference voltage for the REFIN1(+) input of the AD7719.
LK11	OUT	IOUT1*R10 not used as REFIN1 voltage reference.
LK12	OUT	IOUT1*R10 not used as REFIN1 voltage reference.
LK13	OUT	IOUT1*R10 not used as REFIN1 voltage reference.
LK14	A	The on-board reference (U2) provides the reference voltage for the REFIN2 input of the AD7719.

EVALUATION BOARD INTERFACING

Interfacing to the evaluation board is via either a 9-way d-type connector, J4 or a 36-way centronics connector, J1. The pin-out for the J4 connector is shown in Fig. 2 and its pin designations are given in Table 2. The pin-out for the J1 connector is shown in Fig. 3 and its pin designations are given in Table 3.

J1 is used to connect the evaluation board to the parallel (printer) port of a PC. Connection is via a standard printer cable. J4 is used to connect the evaluation to any other system. The evaluation board should be powered up before a cable is connected to either of these connectors.

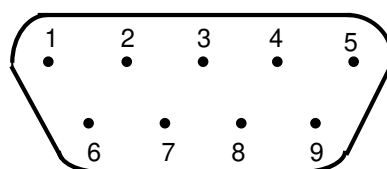

Fig. 2: Pin Configuration for the 9-Way D-Type Connector, J4.

Table 2.: J4 Pin Description ¹

1	SCLK	Serial Clock. The signal on this pin is buffered before being applied to the SCLK pin of the AD7719.
2	\overline{RDY}	Logic output. This is a buffered version of the signal on the AD7719 \overline{RDY} pin
3	\overline{CS}	Chip Select. The signal on this pin is buffered before being applied to the \overline{CS} pin on the AD7719.
4	\overline{RESET}	Reset Input. Data applied to this pin is buffered before being applied to the AD7719 \overline{RESET} pin.
5	DIN	Serial Data Input. Data applied to this pin is buffered before being applied to the AD7719 DIN pin.
6	DGND	Ground reference point for the digital circuitry. Connects to the DGND plane on the Evaluation board.
7	DOUT	Serial Data Output. This is a buffered version of the signal on the AD7719 DOUT pin.
8	DV _{DD}	Digital Supply Voltage. If no voltage is applied to the board's DV _{DD} input terminal then the voltage applied to this pin will supply the DV _{DD} for the digital buffers.
9	NC	Not Connected.

Note

¹An explanation of the AD7719 functions mentioned here is given in Table 3 below as part of the J1 pin descriptions.

Table 3: 36-Way Connector Pin Description

1	NC	No Connect. This pin is not connected on the evaluation board.
2	DIN	Serial Data Input. Data applied to this pin is buffered before being applied to the AD7719 DIN pin. Serial Data Input with serial data being written to the input shift register on the part. Data from this input shift register is transferred to the calibration or control registers, depending on the register selection bits of the Communications Register.
3	\overline{RESET}	Reset Input. The signal on this pin is buffered before being applied to the \overline{RESET} pin of the AD7719. \overline{RESET} is an active low input which resets the control logic, interface logic, calibration coefficients, digital filter and analog modulator of the part to power-on status.

EVAL-AD7719-EB

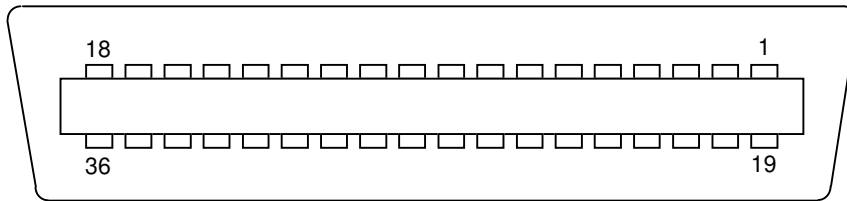

Fig. 3: 36-way Centronics (SKT2) Pin Configuration

4	\overline{CS}	Chip Select. The signal on this pin is buffered before being applied to the \overline{CS} pin of the AD7719. \overline{CS} is an active low Logic Input used to select the AD7719. With this input hard-wired low, the AD7719 can operate in its three-wire interface mode with SCLK, DIN and DOUT used to interface to the device. \overline{CS} can be used to select the device in systems with more than one device on the serial bus or as a frame synchronization signal in communicating with the AD7719.
5	SCLK	Serial Clock. The signal on this pin is buffered before being applied to the SCLK pin of the AD7719. An external serial clock is applied to this input to read/write serial data from/to the AD7719. This serial clock can be continuous with all data transmitted in a continuous train of pulses. Alternatively, it can be non-continuous with the information being transmitted to the AD7719 in smaller batches of data.
6	\overline{SYNC}	Logic Input. The signal on this pin is buffered before being applied to the \overline{SYNC} pin of the AD7719. The \overline{SYNC} input allows for synchronisation of the digital filters and modulators across a number of AD7719s. While \overline{SYNC} is low, the nodes of the digital filter, the filter control logic and the calibration control logic are held in a reset state.
7-8	N C	No Connect. These pins are not connected on the evaluation board.
9	DV_{DD}	Digital Supply Voltage. This provides the supply voltage for the buffer chips, U3-U5, which buffer the signals between the AD7719 and J1/J4.
10	\overline{RDY}	Logic output. This is a buffered version of the signal on the AD7719 \overline{RDY} pin. A logic low on this output indicates that either the Main ADC or Auxiliary ADC has valid data in their data register. The \overline{RDY} pin will return high upon completion of a read operation of a full output word. If data is not read \overline{RDY} will return high prior to the next update indicating to the user that a read operation should not be initiated. The \overline{RDY} pin also returns low after the completion of a calibration cycle. The \overline{RDY} pin is effectively the NOR of the RDY0 and RDY1 bits in the Status register. If one of the ADCs is disabled the \overline{RDY} pin reflects the active ADC. \overline{RDY} does not return high after a calibration until the mode bits are written to enabling a new conversion or calibration.
11-12	N C	No Connect. These pins are not connected on the evaluation board.
13	DOUT	Serial Data Output. This is a buffered version of the signal on the AD7719 DOUT pin. Serial Data Output with serial data obtained from the output shift register on the AD7719. The output shift register can contain information from the on-chip registers depending on the register selection bits of the Communications Register.
14-18	N C	No Connect. These pins are not connected on the evaluation board.
19-30	DGND	Ground reference point for digital circuitry. Connects to the DGND plane on the evaluation board.
31-36	N C	No Connect. These pins are not connected on the evaluation board.

SOCKETS

There are eighteen sockets relevant to the operation of the AD7719 on this evaluation board. The functions of these sockets are outlined in Table 4.

Table 4. Socket Functions

Socket	Function
J4	9-way D-Type connector used to interface to other systems.

J1	36-way centronics connector used to interface to PC via parallel printer port.	SKT13	Sub-Miniature BNC (SMB) Connector. The AD7719 current source pin IOUT2 is connected to this socket.
SKT1	Sub-Miniature BNC (SMB) Connector. The analog input signal for the AIN1 input of the AD7719 is applied to this socket.	SKT14	Sub-Miniature BNC (SMB) Connector. The reference voltage for the REFIN1(-) input of the AD7719 is applied to this socket when the board is configured for an externally applied reference voltage.
SKT2	Sub-Miniature BNC (SMB) Connector. The analog input signal for the AIN2 input of the AD7719 is applied to this socket.	SKT15	Sub-Miniature BNC (SMB) Connector. The reference voltage for the REFIN1(+) input of the AD7719 is applied to this socket when the board is configured for an externally applied reference voltage.
SKT3	Sub-Miniature BNC (SMB) Connector. The analog input signal for the AIN3 input of the AD7719 is applied to this socket.	SKT16	Sub-Miniature BNC (SMB) Connector. The reference voltage for the REFIN2 input of the AD7719 is applied to this socket when the board is configured for an externally applied reference voltage.
SKT4	Sub-Miniature BNC (SMB) Connector. The analog input signal for the AIN4 input of the AD7719 is applied to this socket.		
SKT5	Sub-Miniature BNC (SMB) Connector. The analog input signal for the AIN5 input of the AD7719 is applied to this socket.		
SKT6	Sub-Miniature BNC (SMB) Connector. The analog input signal for the AIN6 input of the AD7719 is applied to this socket.		
SKT7	Sub-Miniature BNC (SMB) Connector. The master clock signal for the XTAL1 input of the AD7719 is applied to this socket when the board is configured for an externally applied master clock. The AD7719 can be operated with internal clock frequencies in the range 32.768kHz +/- 10%.		
SKT8	Sub-Miniature BNC (SMB) Connector. The output value from AD7719 output pin P1/SW1 is available from this socket.		
SKT9	Sub-Miniature BNC (SMB) Connector. The output value from AD7719 output pin P2/SW2 is available from this socket.		
SKT10	Sub-Miniature BNC (SMB) Connector. The output value from the AD7719 I/O pin P3 is available from this socket when P3 is configured as an output. The input signal for AD7719 I/O pin P3 is applied to this input when P3 is configured as an input.		
SKT11	Sub-Miniature BNC (SMB) Connector. The output value from the AD7719 I/O pin P4 is available from this socket when P4 is configured as an output. The input signal for AD7719 I/O pin P4 is applied to this input when P4 is configured as an input.		
SKT12	Sub-Miniature BNC (SMB) Connector. The AD7719 current source pin IOUT1 is connected to this socket.		

CONNECTORS

There are two connectors on the AD7719 evaluation board as outlined in Table 5.

Table 5. Connector Functions

Connector	Functions
J3	PCB Mounting Terminal Block. The Digital Power Supply to the Evaluation Board is provided via this Connector if it is not being supplied via SKT1 or SKT2.
J2	PCB Mounting Terminal Block. The Analog Power Supply to the Evaluation Board must be provided via this Connector.

SWITCHES

There is one switch on the AD7719 Evaluation board. SW1 is a push-button reset switch. Pushing this switch activates the active low $\overline{\text{RESET}}$ input on the AD7719 which resets the control logic, interface logic, calibration coefficients, digital filter and analog modulator of the part to power-on status.

EVAL-AD7719-EB

AD7719 SOFTWARE DESCRIPTION

The AD7719 evaluation board is shipped with a CD-ROM containing software that can be installed onto a standard PC to control the AD7719.

The software uses the printer port of the PC to communicate with the AD7719, so a Centronics printer cable is used to connect the PC to the evaluation board.

Software Requirements and Installation

The software runs under Windows ME 2000 NT™ and typically requires 8Mb of RAM.

To install the software the user should start Windows and insert the CD-ROM disc. The installation software should launch automatically. If not, use Windows Explorer to locate the file 'setup.exe' on the CD-ROM. Double clicking on this file will start the installation procedure. The user is prompted for a destination directory which is "C:\Program Files\ANALOG DEVICES\AD7719" by default. Once the directory has been selected the installation procedure will copy the files into the relevant directories on the hard drive. The installation program will create a Program Group called "Analog Devices" with sub-group 'AD7719' in the "Start" taskbar. Once the installation procedure is complete the user can double click on the AD7719 icon to start the program.

Features of the Software

1. The software will allow the user to write to and read from all the registers of the AD7719.
2. Data can be read from the AD7719 and displayed or stored for later analysis.
3. The data that has been read can be exported to other packages such as Mathcad or Excel for further analysis.

What follows is a description of the various windows that appear while the software is being used. Fig. 4. shows the main screen that appears once the program has started. The printer port that will be used by the software is determined automatically. There are three possible printer ports that can be handled by the software, LPT1 (standard), LPT2 and PRN. The user can change to another printer port by clicking on the "Printer Port" dropdown menu. A brief description of each of the buttons on the main screen follows:

ProgramAD7719	Allows the user to program or read the on-chip registers of the AD7719.
ReadDatafromMainADC	Allows the user to read a number of samples from the AD7719 Main ADC. These samples can be stored for further analysis or just displayed for reference.
ReadDatafromAuxADC	Allows the user to read a number of samples from the AD7719 Aux ADC. These samples can be stored for further analysis or just displayed for reference.
MainADCNoiseAnalysis	Allows the user to perform noise analysis on the data that has been read in from the Main ADC.
AuxADCNoiseAnalysis	Allows the user to perform noise analysis on the data that has been read in from the Aux ADC.
ResetAD7719	Allows the user to perform a software or hardware reset on the AD7719.
ReadFromFile	Allows the user to read in previously stored data for display or analysis - user needs to specify Aux or Main ADC data.
WriteToFile	Allows the user to write the current set of data to a file for later use - user needs to specify Aux or Main ADC data.
About	Provides information about the version of software being used.
ReadDualADC	Allows the user to display samples from the Main and Aux ADCs simultaneously. These samples can be stored for further analysis or just displayed for reference.
Quit	Ends the program



Fig. 4. The Main Screen

EVAL-AD7719-EB

The Program AD7719 Screen

Fig. 5. shows the screen that appears when the Program AD7719 button is selected. This screen allows the user to select which register is to be programmed.

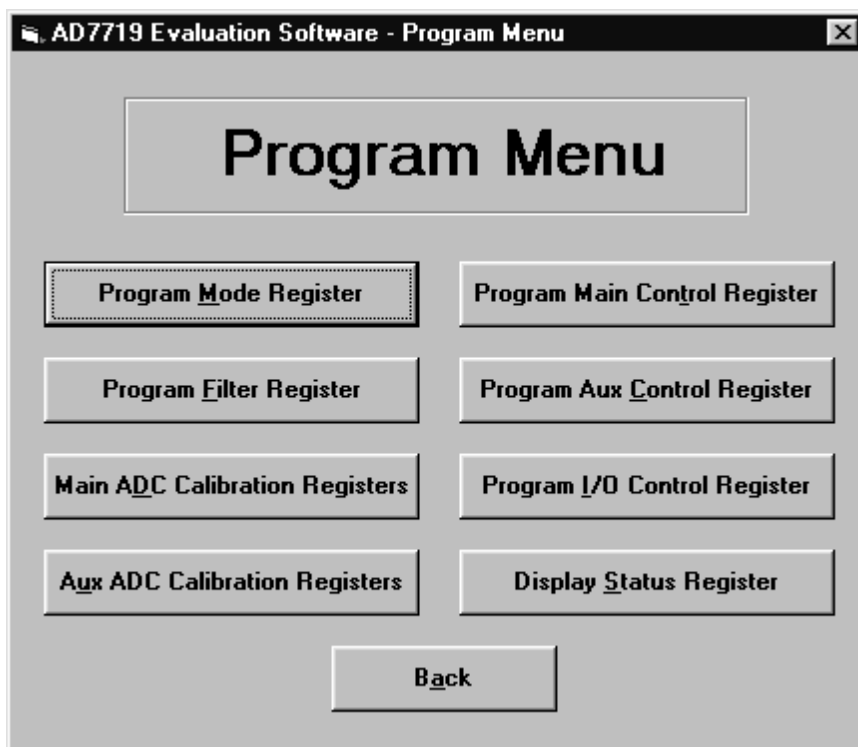

Fig. 5. The Program AD7719 Screen

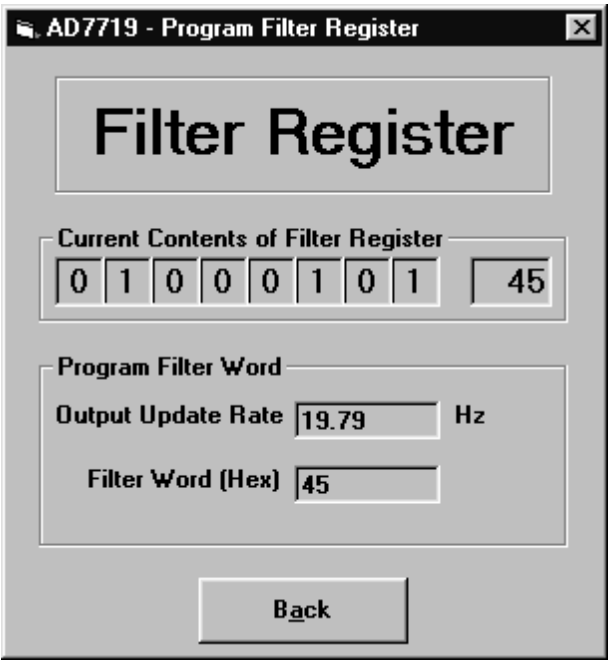

Fig. 6. The Filter Register Screen

The Filter Register Screen

Fig. 6. shows the Filter Register screen. When the screen is loaded the software will read the current contents from the Filter Register of the AD7719 and change the display accordingly. The Filter register is used to change the update rate of the AD7719, the allowable range for the word written to the Filter Register is 13(dec) to 255(dec) or 0D(Hex) to FF(Hex). The user can enter the filter word in Hex values in the text box provided. The user should consult the datasheets for more information on the use of the Filter Register.

EVAL-AD7719-EB

The Main ADC Calibration Registers Screen

Fig. 7. shows the Main ADC Calibration Registers screen. When this screen is displayed the values of the Gain and Offset Registers are read from the Main ADC of the AD7719 and displayed. The user has the ability to change the values of either register if required. the default value for the Fullscale Main Cal Register is 535xx5 hex and the default value for the Zero Scale Main Cal Register is 800000 hex. The AuxADC Calibration Registers screen has the same function with the default values being 555X hex for the Full Scale Aux Cal Register and 8000 hex for the Zero Scale Aux Cal Register.

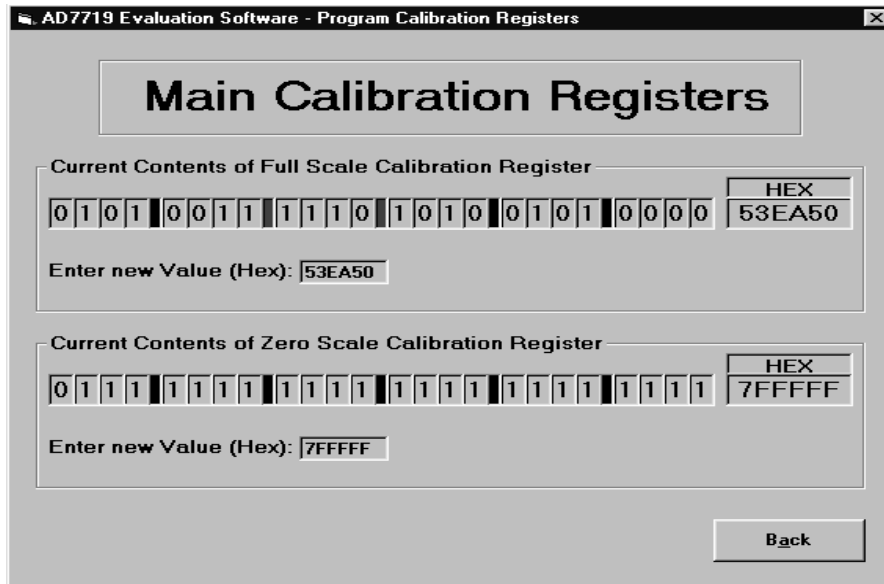

Fig. 7. The Calibration Registers Screen

The Main ADC Control Register Screen

Fig. 8. shows the Main ADC Control Register Screen. This register controls the Word-length, Bipolar/Unipolar operation, Channel selection and Range selection for the Main ADC. When the screen is loaded the software reads the current contents from the Main ADC Control Register of the AD7719 and sets the buttons accordingly. Note if the Channel Configure bit is set in the Mode Register the channels the Main and Aux ADCs can use is changed - see AD7719 datasheets for more information. Everytime a change is made, the software writes the new conditions to the AD7719 and then reads back from the Main ADC Control Register for conformation. The Aux ADC Control Register Screen performs a similar operation for the Aux ADC Control Register - see AD7719 datasheets for more information.

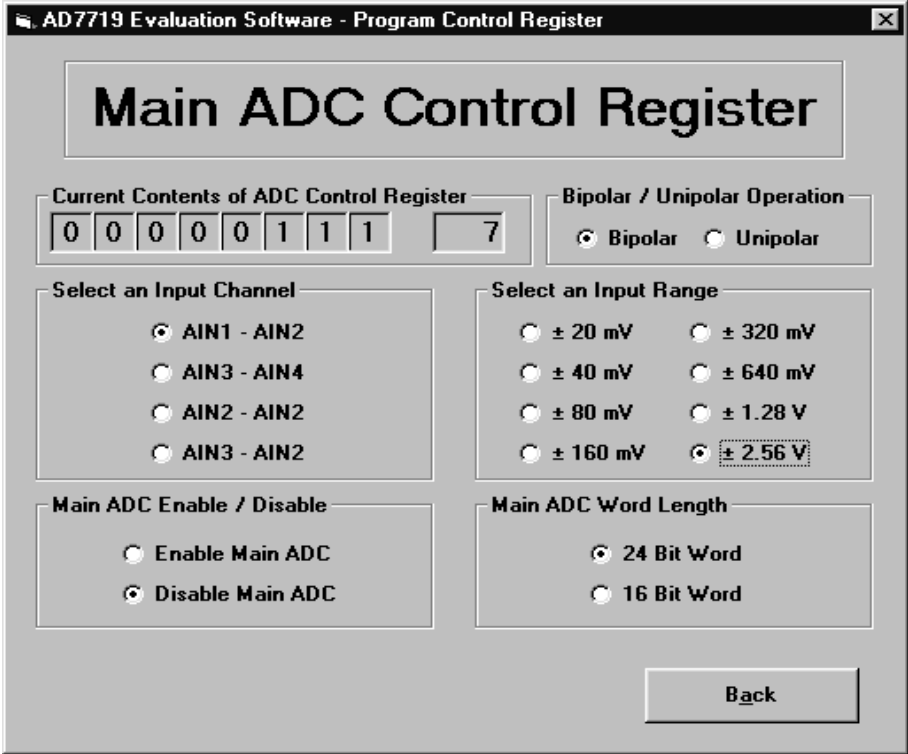

Fig. 8. The Main ADC Control Register Screen

EVAL-AD7719-EB

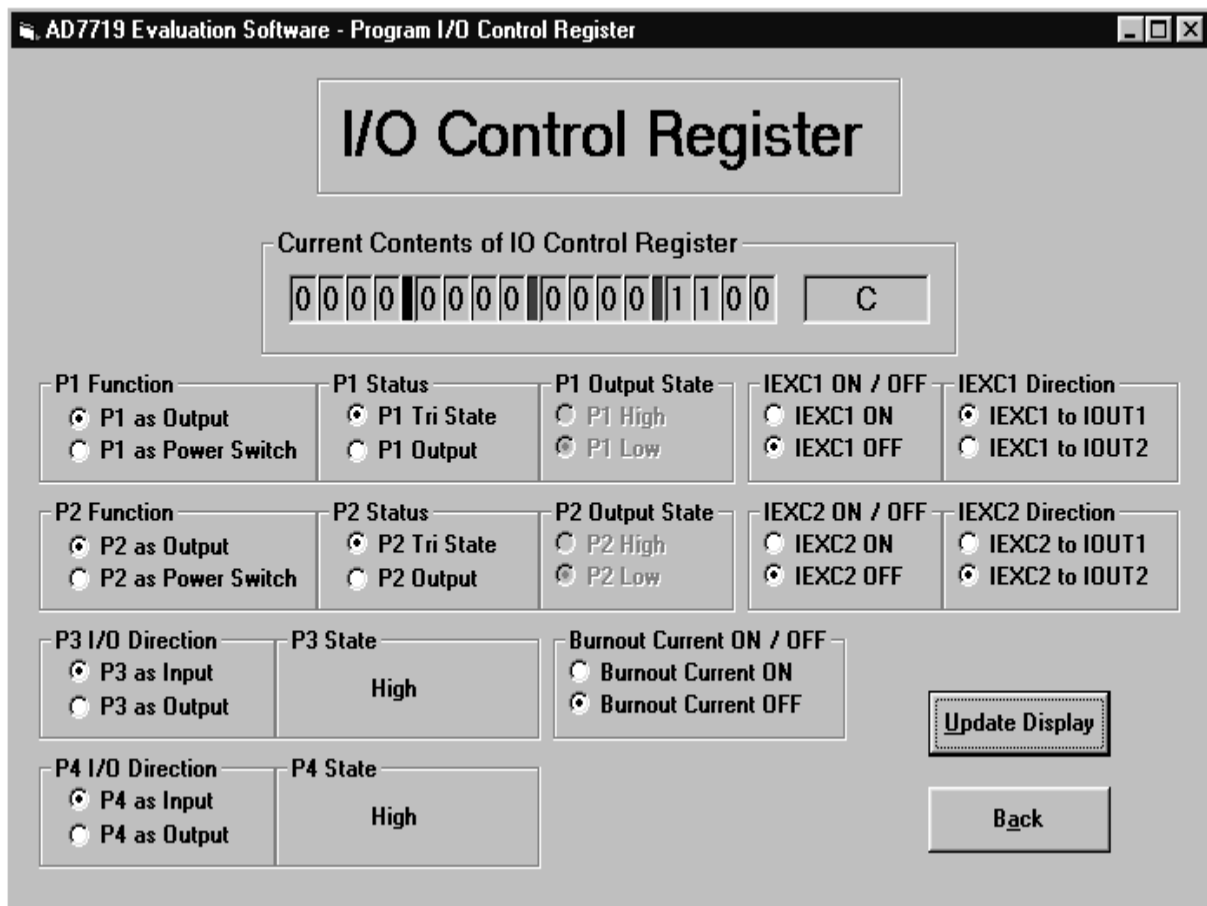

Fig. 9. The I/O and Current Source Control RegisterScreen

The I/O and Current Source Control Register Screen

Fig.9. shows the I/O and Current Source Control Register Screen. This screen allows the user to control the on-chip 200uA current sources and also the two I/O ports P3 & P4 and the output ports P1 & P2. When the screen is loaded, the software reads the current contents of the I/O and Current Source Control Register of the AD7719 and sets the buttons accordingly. The current sources IEXC1 & IEXC2 can be enabled and directed to the two AD7719 output pins IOUT1 & IOUT2 by the user. The on-chip burnout current can be turned on/off by the user.

The two I/O ports P3 & P4 can be selected as inputs or outputs, the user can set the outputs as required - note 'high' represents a 5V output on the pin, 'low' represents AGND. The user can also read in the value at the inputs P3 & P4 if configured as inputs. Note pressing Update Display button will read the current contents of the I/O and Current Source Control Register and update the screen.

The two outputs P1 & P2 can be configured as a standard Output pin or as a Power Switch to PWRGND. When selected as an Output pin P1 or P2 can be enabled as a regular digital output or as a tri-state output. Everytime a change is made, the software writes the new conditions to the AD7719 and then reads back from the I/O and Current Source Control Register for conformation - ignoring databits P1DAT - P4DAT. Refer to AD7719 datasheets for more information.

The Mode Register Screen

The Mode Register Screen is shown in Fig. 10. When the screen is loaded the software reads the current contents from the Mode Register of the AD7719 and sets the buttons accordingly. This screen allows the user to change the operating mode of the AD7719, change the channel configuration and power down the crystal oscillator. When the user selects a calibration the software will start a calibration by writing to the AD7719 (prompt user for input if system calibration) and then monitor the RDY pin. A falling edge of the RDY pin will indicate that the calibration has been completed. After a calibration the AD7719 is placed in the idle mode and the screen is updated to indicate this. Everytime a change is made, the software writes the new conditions to the AD7719 and then reads back from the Mode Register for conformation. The AD7719 should be powered-down or placed in Idle Mode before writing to Filter, ADC Control or Calibration registers. The default status for the Mode register is 0 hex - refer to AD7719 datasheets for more information.



Fig. 10. The Mode Register Screen

The Status Register Screen

Fig. 11. shows the Status Register Screen. When the screen is loaded the software reads the current contents from the Status Register of the AD7719 and sets the buttons accordingly. This is a read-only register and flags the operating conditions of the AD7719 such as data ready or Main ADC Error. Refer to AD7719 datasheets for more information.

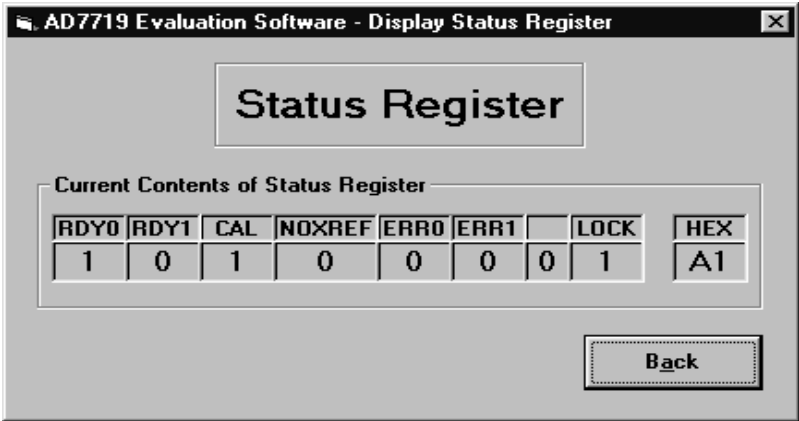

Fig. 11. The Status Register Screen

EVAL-AD7719-EB

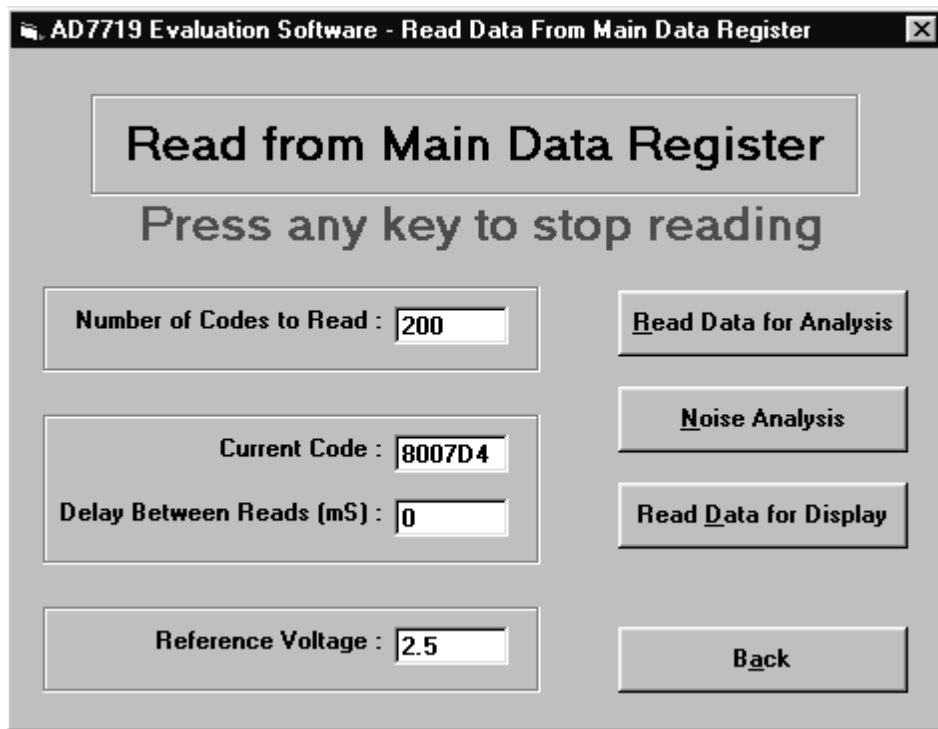

Fig. 12. The Read Data from Main ADC Screen

The Read Data from Main ADC Screen

Fig. 12. shows the Main ADC Read Data screen. This is where the user can read a number of samples from the AD7719 Main ADC. The user has the option of either reading data for analysis or display.

When the Read For Analysis button is selected the software will read the required number of samples from the AD7719 Main ADC and store them in an array so that they can be graphed or analysed later. It is possible to read and graph up to 5000 samples at any one time. The read can be interrupted with a user key press.

When the Read for Display button is selected the software will read one sample from the AD7719 and display its value in the Current Code text box. The software will continue to read and display the samples until a key has been pressed. It is possible to add a delay to the read cycle by entering the required number of milliseconds between reading samples. It should be noted however that the accuracy of the time delay can be affected by other programs running under Windows, therefore this method is not suitable where equidistant sampling is required. Note the Read Data from Aux ADC Screen has a similar function to the Read Data from Main ADC Screen, only reading from the Aux ADC and storing in a separate array.

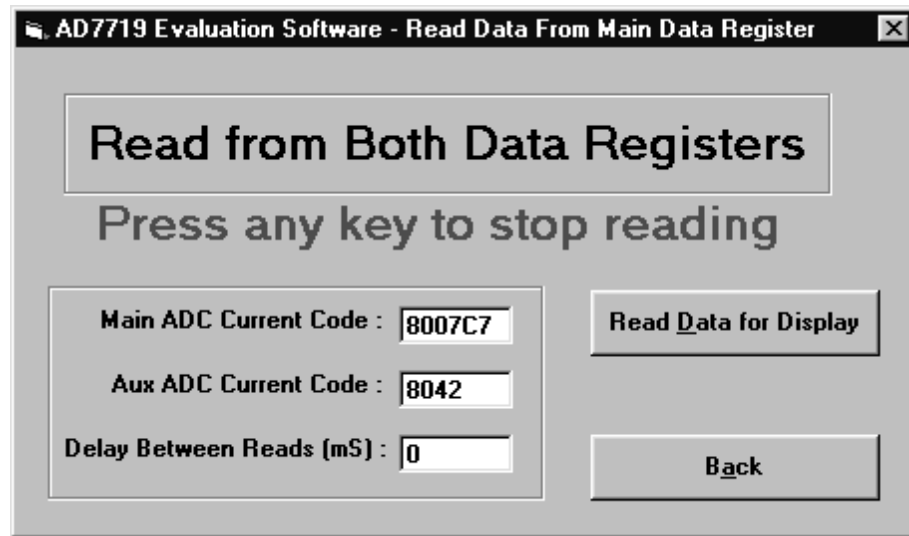

Fig. 13. The Read Data from Dual ADC Screen

The Read Data from Dual ADC Screen

Fig. 13 shows the Read Data from Dual ADC display. This is where the user can read a number of samples from both ADCs simultaneously. The results are stored in two arrays so that the results can be graphed or analysed later by selecting the Aux or Main ADC Noise Analysis Buttons on the Main Menu Screen. It is possible to read and graph up to 5000 samples at any one time. The read can be interrupted with a user key press. Note both ADCs must be enabled for this screen to operate. The user is informed if both ADCs aren't enabled. This will also overwrite results from single Main or Aux ADC analysis unless the data has been saved.

When the Read for Display button is selected the software will read one sample from the AD7719 and display its value in the Current Code text box. The software will continue to read and display the samples until a key has been pressed. It is possible to add a delay to the read cycle by entering the required number of milliseconds between reading samples. It should be noted however that the accuracy of the time delay can be affected by other programs running under Windows, therefore this method is not suitable where equidistant sampling is required.

EVAL-AD7719-EB

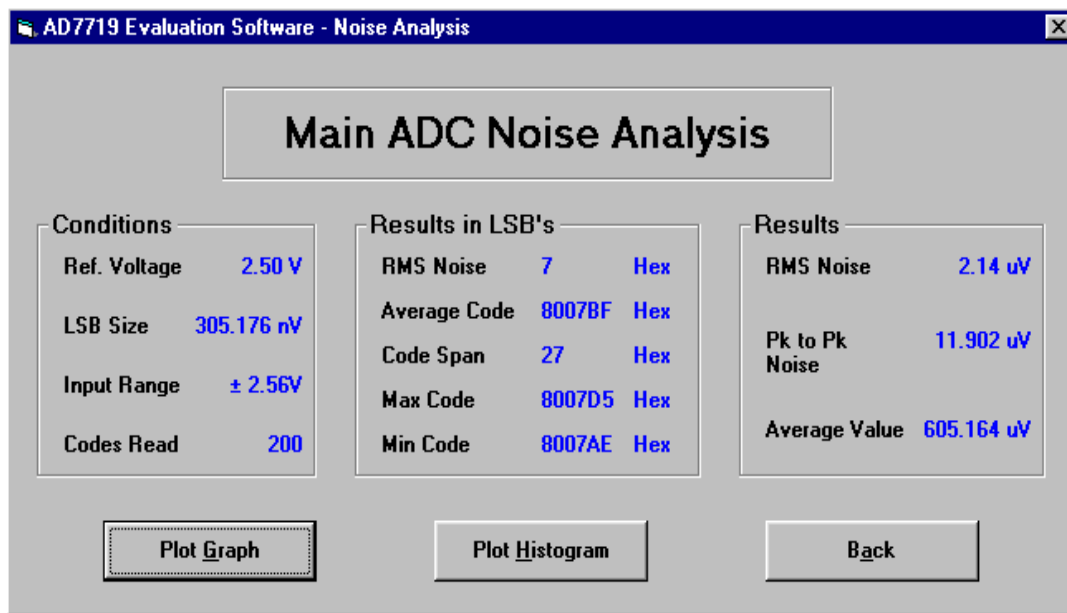

Fig. 14. The Main ADC Noise Analysis Screen

The Main ADC Noise Analysis Screen

Once data has been read from the AD7719 Main ADC, it is possible to perform some analysis on it. Fig. 14 shows the Main ADC Noise Analysis Screen. This screen displays the maximum and minimum codes read from the AD7719 Main ADC (in decimal and hexadecimal), as well as the average code, the average value and the RMS and Peak-Peak noise values. From this screen it is possible to display the data on a graph or as a histogram of codes. Figures 15 & 16 show the Graph and Histogram screens. The Aux ADC Noise Analysis Screen performs the same function on data from the Aux ADC.

The Main ADC Graph Screen

Fig. 15 shows the Main ADC Graph Screen. This screen displays the data in a graph format. A grid can be placed on the graph by pressing the Grid on/off button. The graph screen also has zoom and scroll functions using the two white handles at either end of the x-axis.

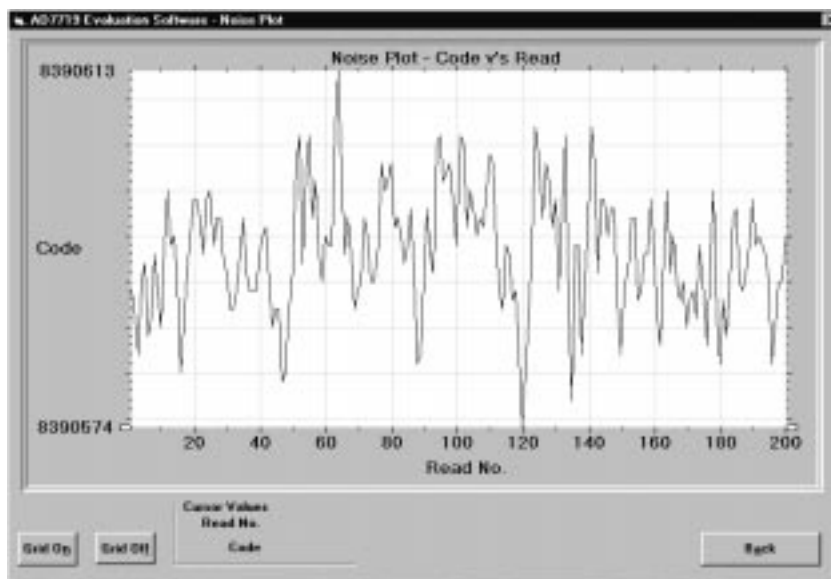

Fig. 15. The Main ADC Graph Screen

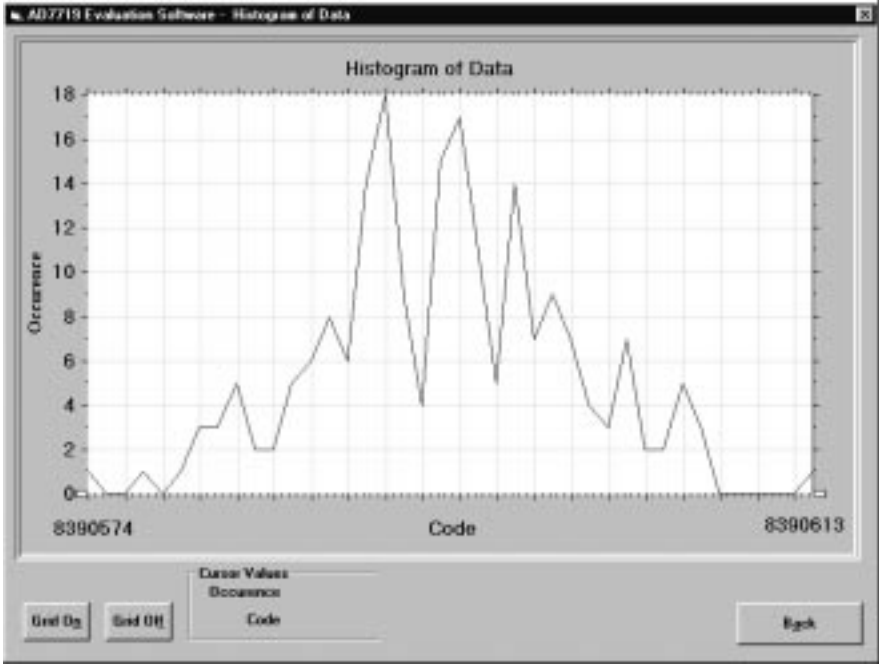

Fig. 16. The Main ADC Histogram Screen

Table 6. Component Listing and Manufacturers

INTEGRATED CIRCUITS

Component	Location	Vendor
AD7719	U1	Analog Devices
AD780AN	U2/U6	Analog Devices
74HC4050N	U3	Philips
74C08SMD	U4	Texas Instruments
74ACT244	U5	Fairchild Semiconductor
SD103C	D1/D2	ITT

CAPACITORS

Component	Location	Vendor
10 μ F \pm 20% Tantalum (16 V)	C12 C13 C17 C19 C20 C22 C23 C24	AVX-Kyocera Mftrs No. TAG106MO16
0.1 μ F Ceramic (0805 SMD)	C1-C6 C8 C15 C18 C21	FEC No. 499-768
0.1 μ F Ceramic (X7R \pm 20%)	C7 C9 C10 C11 C14 C16	Philips Mftrs No. CW20C104M

RESISTORS

Component	Location	Vendor
Short Circuits	R1-R6	Bourns
10k Ω \pm 5% 0.25W Carbon Film	R7-R9	Bourns
12k Ω \pm 5% 0.25W Carbon Film	R10	Bourns
3k Ω \pm 5% 0.25W Carbon Film	R12	Bourns

LINK OPTIONS

Component	Location	Vendor
Pin Headers	Lk1-Lk6 Lk11-Lk13 (1x2 way) Lk7 Lk8 (2x2 way) Lk9 Lk10 Lk14 (3x2 way)	Harwin Mftrs No. M20-9983606
Shorting Plugs	Pin Headers (14 required)	Harwin Mftrs No. M7571-05

SWITCH

Component	Location	Vendor
Sealed Push Button Switch	SW1	Omron Mftrs No. B3W1000

SOCKETS

Component	Location	Vendor
Miniature BNC Connectors	SKT1-SKT16	M/A - Com Greenpar Mftrs No. B65N07G999X99
9-Way D-Type Connector	J4	McMurdo Mftrs No. SDE9PNTD

EVAL-AD7719-EB

36 Way Centronics Connector J1
 2 Way Terminal Block J1J2
 Low profile socket U2,U3,U6

Fujitsu Mftrs No. FCN785J036G0
 Bulgin RIA
 Harwin (32 pins needed)
 Farnell No. 519-959

CRYSTAL OSCILLATOR

Component	Location	Vendor
32.768 kHz Oscillator	Xtal 1	IQD FEC No. 221-533

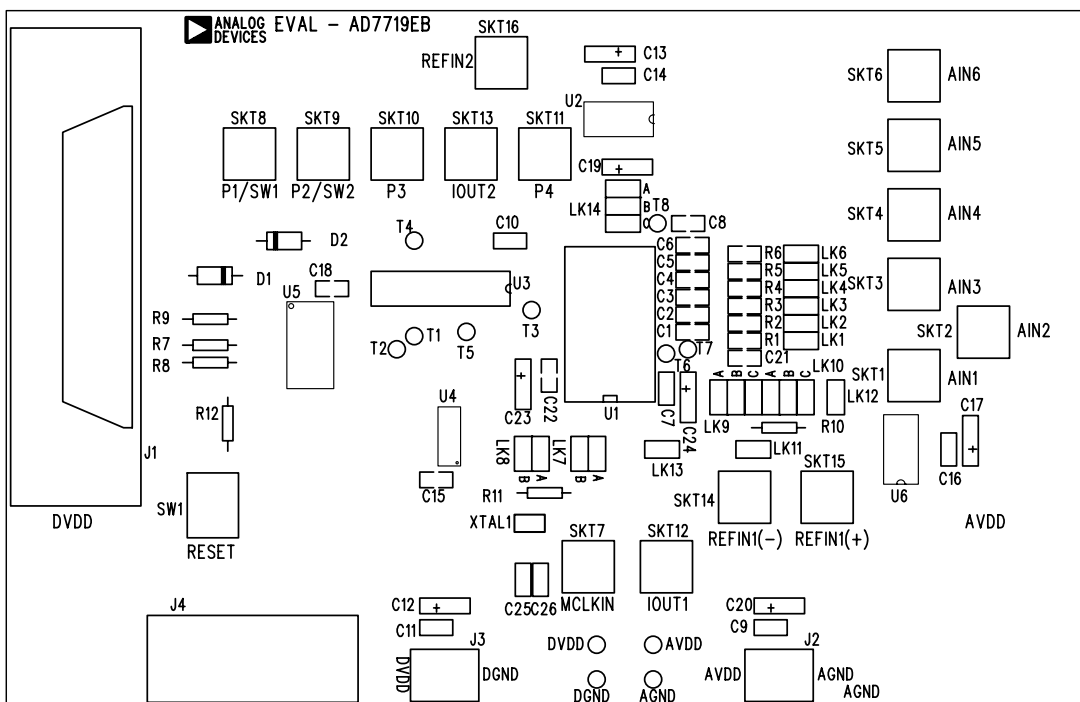

Fig. 18. The Evaluation Board Component Layout Diagram

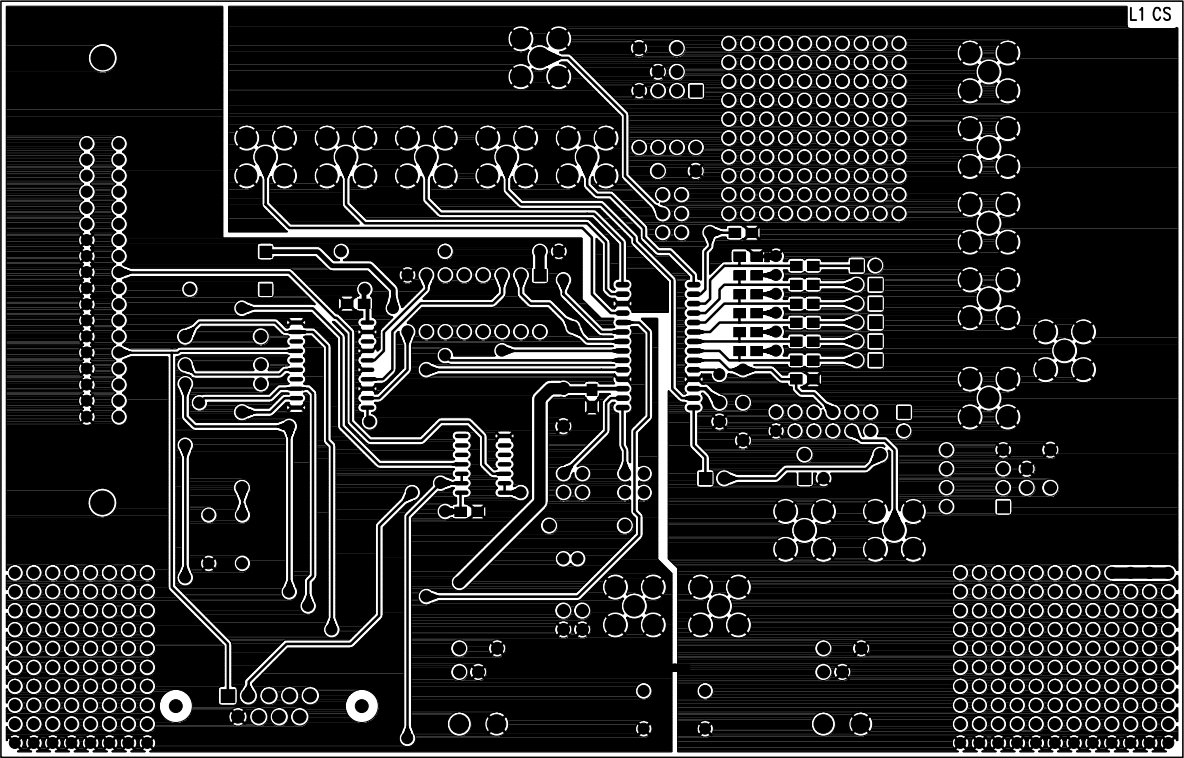

Fig. 19. The Evaluation Board Component Side Artwork

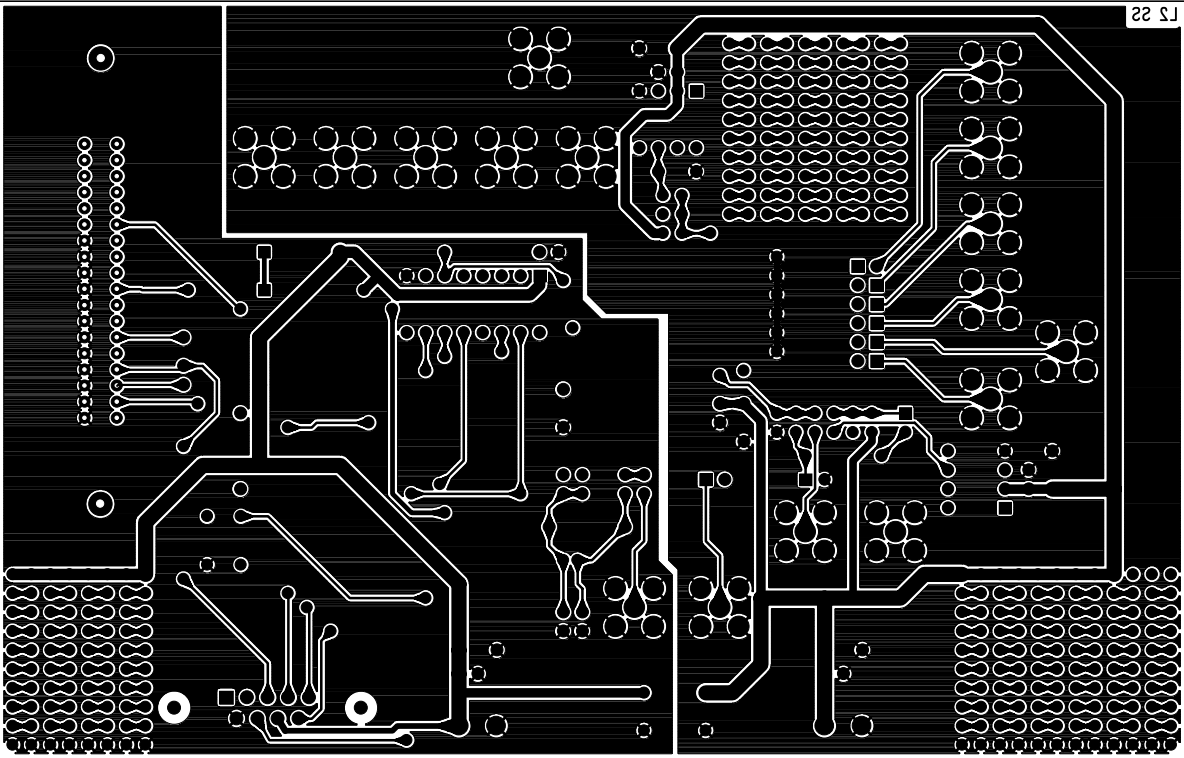

Fig. 20. The Evaluation Board Solder Side Artwork