



Chipsmall Limited consists of a professional team with an average of over 10 year of expertise in the distribution of electronic components. Based in Hongkong, we have already established firm and mutual-benefit business relationships with customers from,Europe,America and south Asia,supplying obsolete and hard-to-find components to meet their specific needs.

With the principle of "Quality Parts,Customers Priority,Honest Operation,and Considerate Service",our business mainly focus on the distribution of electronic components. Line cards we deal with include Microchip,ALPS,ROHM,Xilinx,Pulse,ON,Everlight and Freescale. Main products comprise IC,Modules,Potentiometer,IC Socket,Relay,Connector.Our parts cover such applications as commercial,industrial, and automotives areas.

We are looking forward to setting up business relationship with you and hope to provide you with the best service and solution. Let us make a better world for our industry!



Contact us

Tel: +86-755-8981 8866 Fax: +86-755-8427 6832

Email & Skype: info@chipsmall.com Web: www.chipsmall.com

Address: A1208, Overseas Decoration Building, #122 Zhenhua RD., Futian, Shenzhen, China



ADXRS800 Sensor Evaluation System

FEATURES

Flexible inertial sensor evaluation platform

Single main board operates with interchangeable satellite boards

Separates DUT from controller for accurate environmental testing

500 Hz data rate SPI interface

Continuous stream to file data recording

Standard USB cable for power and communications

PC-based graphical user interface (GUI)

Fast, easy installation

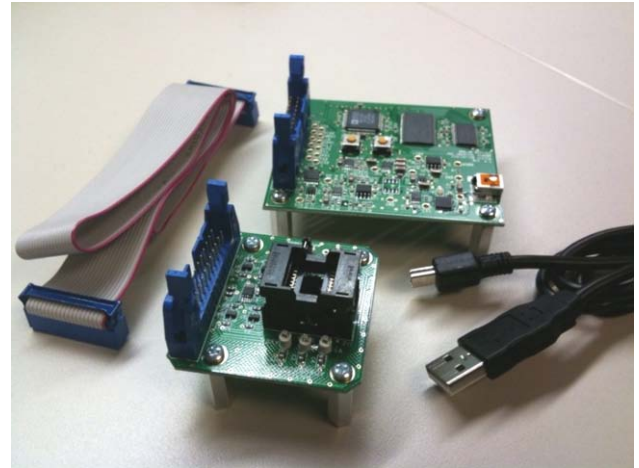

Figure 1. Inertial Sensor Evaluation System

GENERAL DESCRIPTION

The ADXRS800 inertial sensor evaluation system is an easy-to-use evaluation tool targeting bench or desktop characterization of Analog Devices, Inc., inertial sensor products. The system consists of the inertial sensor evaluation board (ISEB), or main board, and a satellite board for any Analog Devices inertial sensor product. The ISEB connects directly to a PC via a USB cable, with the USB connection providing both power and communications to the board. The ISEB is connected to the satellite board through a ribbon cable. This cable allows the satellite to be easily manipulated for testing or separately placed into an environmental chamber for temperature or humidity testing. Separating the boards mitigates corruption of data due to the temperature and humidity effects of other components.

The ISEB is a universal main board and is intended to be used with various satellites of Analog Devices inertial sensors, including analog and digital accelerometers and gyroscopes. The different products are evaluated by means of separate GUIs that are customized for performance and characterization measurements relevant to the inertial sensor being evaluated.

The EVAL-ADXRS800Z-M system contains the ISEB and the EVAL-ADXRS800Z-S satellite. Also included is a USB A to Mini-B cable to connect the ISEB to a PC and an 18 inch, 20-pin

ribbon cable to connect the ISEB to the satellite. A CD is included with the necessary drivers and installers to use the system and to quickly begin evaluating the ADXRS800.

INSTALLATION PROCEDURE

The following steps must be completed, in the order listed, to successfully set up and run the ADXRS800 evaluation system:

1. Download all CD-ROM files to the PC hard drive.
2. Install the USB drivers for the inertial sensor evaluation system (ISEB).
3. Connect the ISEB hardware to the PC.
4. Install the latest firmware revision into the ISEB hardware (included on the CD-ROM).
5. Install the ADXRS800 evaluation system GUI.
6. Configure the ISEB hardware.
7. Launch the ADXRS800 evaluation system GUI and test devices.

This guide is designed to provide all the detail necessary to install and operate the ADXRS800 evaluation system.

TABLE OF CONTENTS

Features	1	Getting Started.....	8
General Description	1	View and Record Data Panel	9
Installation Procedure.....	1	Temperature Test Panel	10
Revision History	2	Noise and Root Allan Variance Panel.....	11
Inertial Sensor Evaluation System Setup	3	Turn-On Bias Stability Panel	12
Downloading All Files to a PC	3	Turn-On Bias Settling Panel	13
ISEB Hardware Setup	3	Sensitivity Check Panel.....	14
COM Port Verification	3	Alternate External High Voltage Supply	15
Installing the Latest ISEB Firmware.....	4	Header Pinout	16
Hardware Configuration	7		
Inertial Sensor Evaluation System Graphical User Interface.....	8		

REVISION HISTORY

3/11—Revision 0: Initial Version

INERTIAL SENSOR EVALUATION SYSTEM SETUP

DOWNLOADING ALL FILES TO A PC

Before proceeding with the installation routine, it is important to first download all files included on the ADXRS800 installation CD-ROM to a local folder on the host PC. Browse to a destination directory on the host PC and right click to select **New/Folder**. Name this folder, and copy the CD-ROM files into this new location. You are now ready to begin the installation routine.

ISEB HARDWARE SETUP

Before connecting the ISEB hardware to the PC via the included USB cable, drivers must be installed so that the PC properly recognizes the ISEB main board. The USB drivers for the ISEB are available in the /ISEB_USB/ folder on the packaged CD.

Installing the USB Drivers for the ISEB

To install the USB drivers, follow these steps:

1. Execute the **ADI_ISEB_USB_Drivers.exe** file located in /ISEB_USB/.
2. Follow the on-screen instructions to install the drivers.
3. Click **Continue Anyway** when prompted that the drivers are not tested.

After the above steps are complete, you can connect the ISEB main board to the computer via the included USB cable. If the previously installed drivers are not automatically associated with the device, you may need to select the drivers manually, as follows:

1. Connect the USB A to Mini-B cable to the PC and then to the ISEB. The satellite board does not need to be connected for this step. New hardware is detected upon completion of this step.
2. If prompted to install drivers again, click **Install from a list or specific location (Advanced)** (see Figure 2); then click **Next**.

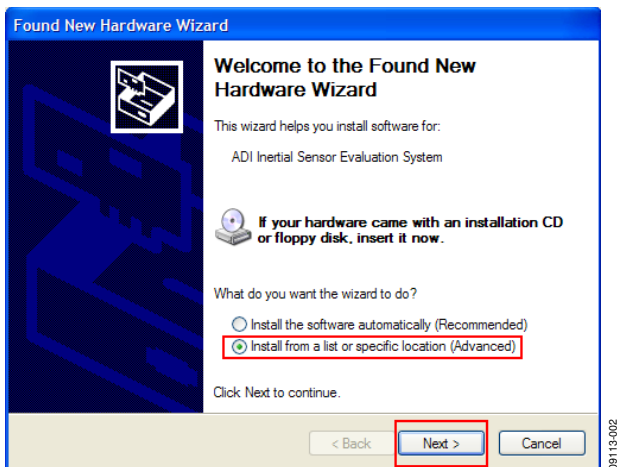

Figure 2. Found New Hardware Prompt

3. Select **Don't search. I will choose the driver to install** (see Figure 3), and click **Next**.

4. Select **ADI Inertial Sensor Evaluation System** from the model list (see Figure 4), and click **Next** to complete the process.

The ISEB should be detected automatically in the **Device Manager** as the **ADI Inertial Sensor Evaluation System** under the **Ports (COM & LPT)** selection. It is recommended to open the **Device Manager** to verify hardware detection and to record the communication port associated with the ISEB for use in the GUI.

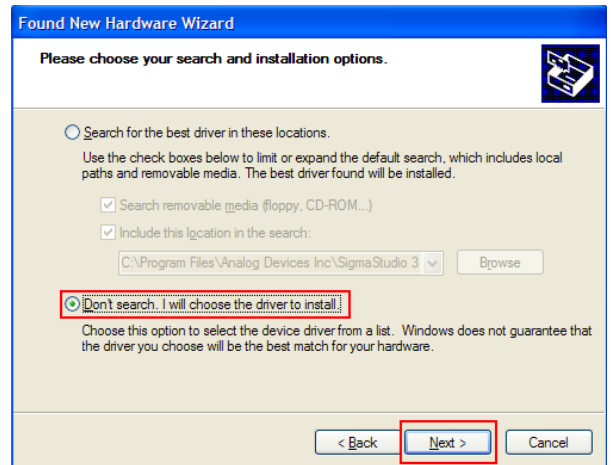

Figure 3. Selection of the Driver to Install

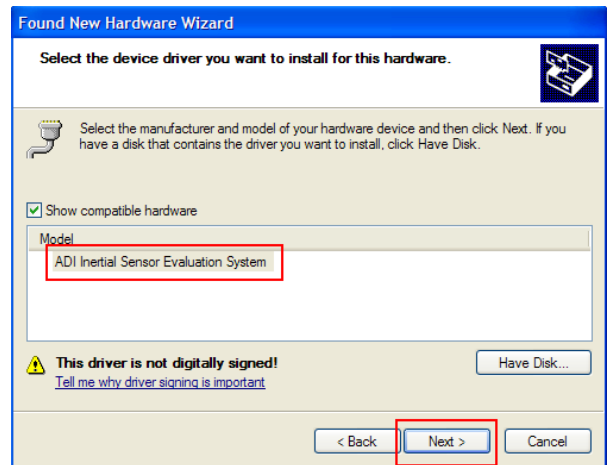

Figure 4. Selection of the ADI Inertial Sensor Evaluation System Drivers

COM PORT VERIFICATION

Installing the latest firmware revision, as well as operating the ADXRS800 evaluation GUI, requires that you know the communications port that is assigned to the ISEB main board. With the ISEB main board connected to the PC, you should perform the following steps to determine the assigned COM port number.

For Windows® Vista,

1. From the **Start** menu, right click **Computer** and select **Properties**. The window shown in Figure 5 should open.
2. Underneath **Tasks**, select **Device Manager**. Windows Vista may request that you allow access to this panel, and administrative privileges may also be required. The window shown in Figure 6 should now open.
3. Expand the **Ports (COM & LTP)** menu item. **ADI Inertial Sensor Evaluation System** should be listed with an assigned COM port number in parenthesis.
4. Note the COM port number for future use.

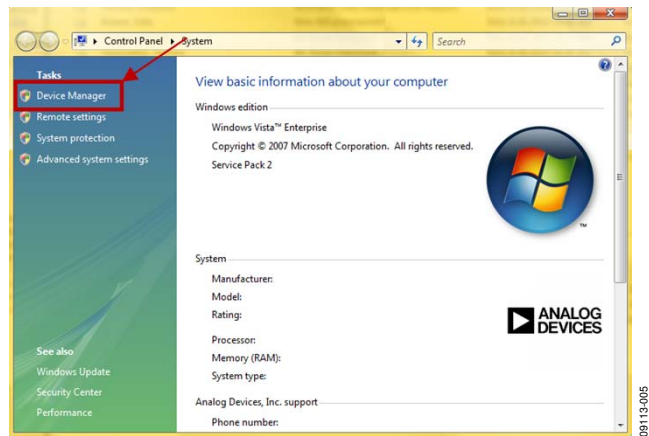

Figure 5. Computer Properties

For Windows XP/2000,

1. From the **Start** menu, right click **My Computer** and select **Properties**.
2. Click the **Hardware** tab of the **System Properties** window, as shown in Figure 7.
3. Select **Device Manager** to look up the assigned COM port of the ISEB hardware.

The **Device Manager** window should look like the window shown in Figure 6.



Figure 7. System Properties

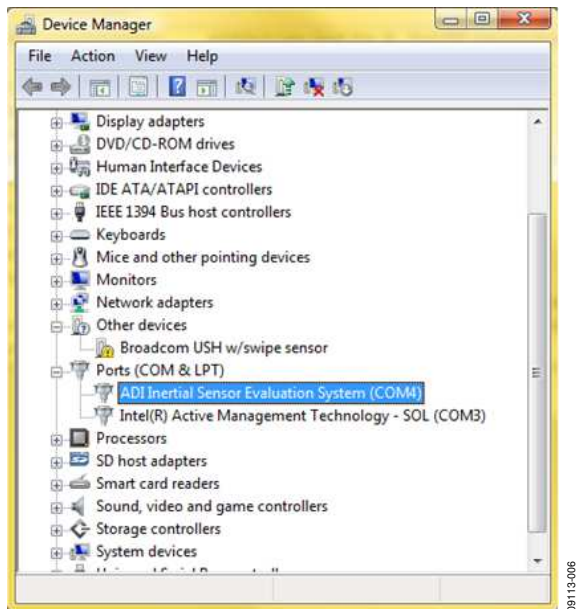

Figure 6. Device Manager Showing the COM Port Number

INSTALLING THE LATEST ISEB FIRMWARE

The latest ISEB firmware is included on the installation CD. To successfully use the ISEB evaluation hardware, this firmware must be flashed to the ISEB controller. The installation CD contains the firmware itself and the utility that allows you to flash a new version of the firmware onto the ISEB microcontroller. In addition, as new firmware is made available, it can be downloaded from the Analog Devices website (www.analog.com).

To flash the ISEB microcontroller, follow these steps:

1. Ensure that the ISEB is connected to and detected by the PC. The COM port on which the device is recognized must also be obtained, as mentioned in the COM Port Verification section.
2. Run the **ARMWSD.exe** program located in the **/ISEB_USB/FW/** folder; it displays information about the downloader, as shown in Figure 8.

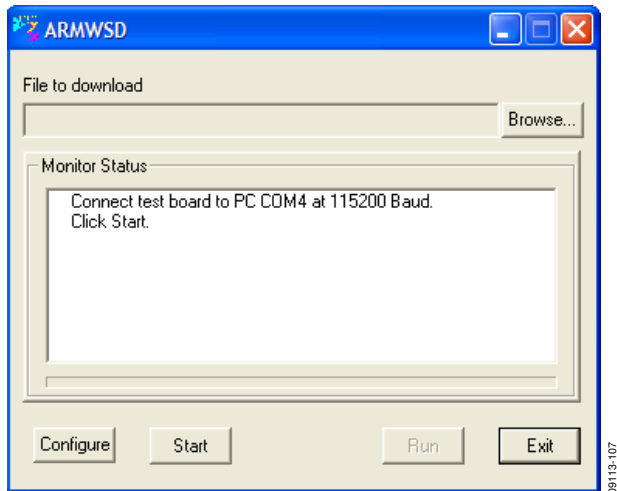

Figure 8. ISEB ARMWSD Firmware Downloader

3. Click **Browse...** and select the **ADI_ISEB_FW_2_0.hex** file located in the **/ISEB_USB/FW/** folder or the most recent firmware obtained from the Analog Devices website (www.analog.com).
4. Click **Configure** to display the box shown in Figure 9.

The downloader file should be configured for the **ADuC7026** microcontroller on the ISEB. The only option you may need to change is the COM port. You can select the correct port from the **Serial Port** menu on the **Comms** tab (see Figure 9).

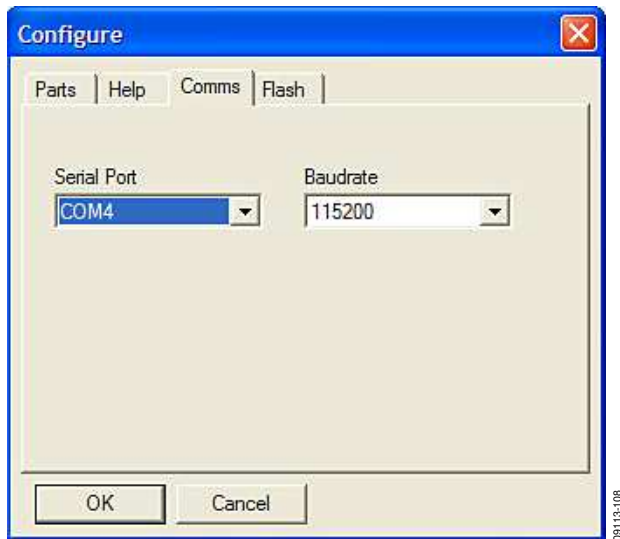

Figure 9. Selecting the Correct COM Port for the Downloader

When the COM port is selected, click **OK** to accept the changes and go back to the ARMWSD box (shown in Figure 8).

When the ISEB is connected, the correct firmware is selected, and the downloader is fully configured, follow these steps to flash the firmware:

1. Click **Start** in the ARMWSD box (see Figure 8) to initiate the flashing process. After clicking **Start**, click the two buttons (shown in Figure 10) on the ISEB in the following order to flash the firmware:

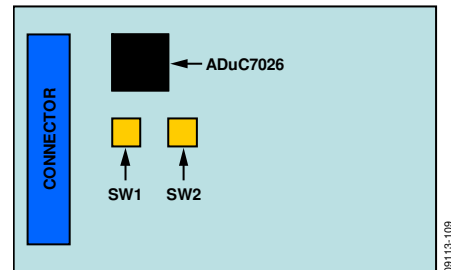

Figure 10. ISEB Switch Locations for Flashing the Microcontroller

- a. Press and hold down **SW1**.
- b. With **SW1** held down, press and release **SW2**.
- c. Release **SW1**.

The download begins and is automatically verified by the downloader.

2. If the downloading process fails, which is indicated in the **Monitor Status** box (see Figure 8), attempt the download again by clicking **Start** and then pressing the appropriate switch combination. It may take a few attempts to reprogram the board successfully.
3. After the download has completed successfully, click **Run** (as shown in Figure 8) to reset the ISEB and to begin running the new firmware.

When this step is complete, the board is updated correctly.

Updating the firmware may require that a new evaluation GUI be obtained. If the firmware on the CD is used to flash the ISEB, the evaluation GUI on the corresponding CD is sufficient. If the firmware used is obtained from the Analog Devices website (www.analog.com), the most recent version of the evaluation GUI, which is also located on the website, should be used.

Installing the ADXRS800 Software Evaluation GUI

The software GUI installation has been created to include any required National Instruments drivers and run-time engines that are necessary for proper operation. To run the software GUI installation routine, double-click the **setup.exe** file located in the **/ADXRS800 Evaluation Software/** folder on the included CD. The window shown in Figure 11 is displayed.

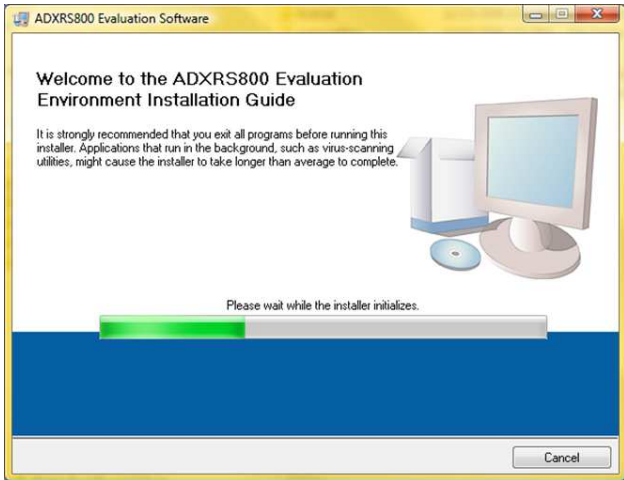

Figure 11. ADXRS800 Evaluation Software Installation Welcome

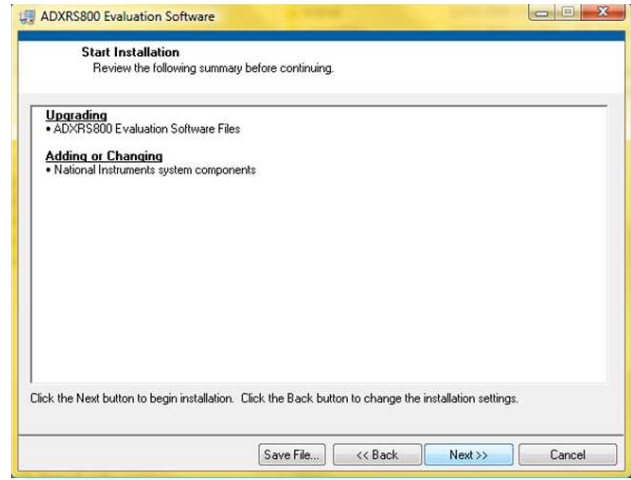

Figure 13. Start Installation (Listing Varies Based on PC Requirements)

From this point, complete the following steps to install the evaluation software:

1. Select the destination directory. The installer autopopulates the names of the directories in which to store the software GUI and required National Instruments products (see Figure 12). You can change these directories; however, most installations can proceed with the default values.
2. When you finish selecting a directory, click **Next**. The National Instruments Software License Agreement is displayed.
3. Read the license agreement before accepting it; then, click **Next**. The installer lists the required components to install on your PC (see Figure 13).
4. To start the installation, click **Next**. The installer completes installation of the software evaluation GUI and all required National Instruments drivers and run-time engines. After the installation is complete, the box shown in Figure 14 is displayed.
5. Click **Finish** to complete the installation.

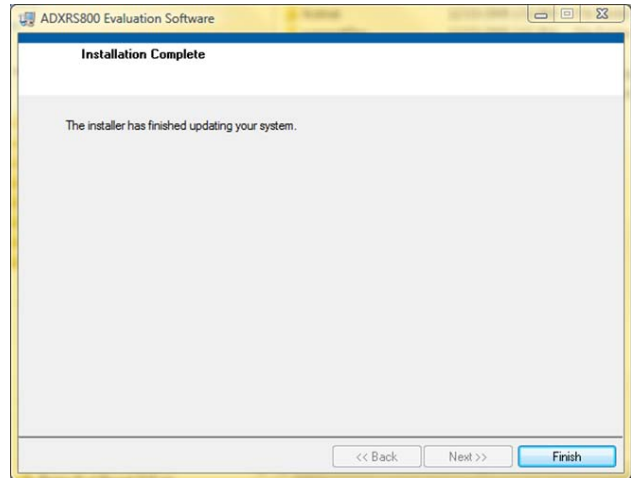

Figure 14. Installation Complete

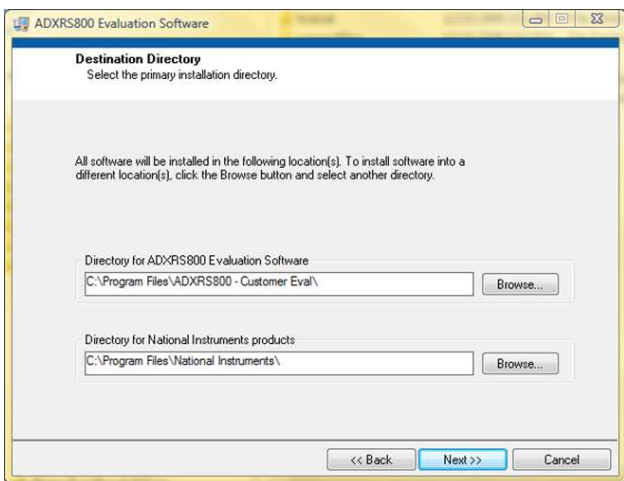

Figure 12. Destination Directory Selection

HARDWARE CONFIGURATION

To configure the hardware, follow these steps:

1. If the hardware is not already connected, plug the USB A to Mini-B cable into the PC.
2. Connect the ISEB to the USB cable.
3. If prompted to install the device, see the Downloading All Files to a PC section for details on how to install and select the correct driver.
4. Ensure that the jumpers on the ADXRS800 satellite are in their default configuration, as shown in Figure 15. This sets up the board to use the on-board boost converter to generate the required high voltage supply for the device. For more information on using alternate high voltage supplies, see the ADXRS800 data sheet and the Alternate External High Voltage Supply section of this guide.

5. Connect the ISEB to the ADXRS800 satellite using the 18-inch, 20-pin ribbon cable. This cable is keyed to prevent inserting it backward and causing damage to the system.
6. Connect the ADXRS800 satellite to the opposite end of the ribbon cable.

The inertial sensor evaluation system should now be set up and ready to use and should resemble the setup shown in Figure 16.

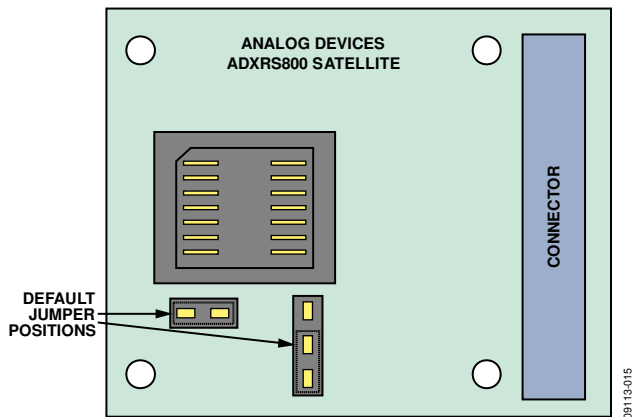

Figure 15. Default Jumper Positions

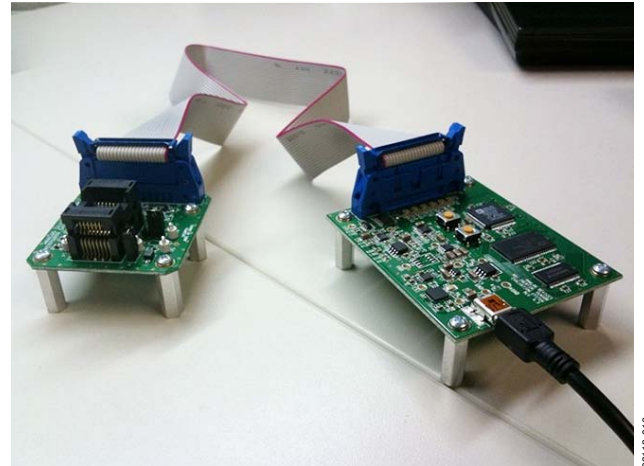

Figure 16. Fully Assembled Evaluation Kit

INERTIAL SENSOR EVALUATION SYSTEM GRAPHICAL USER INTERFACE

GETTING STARTED

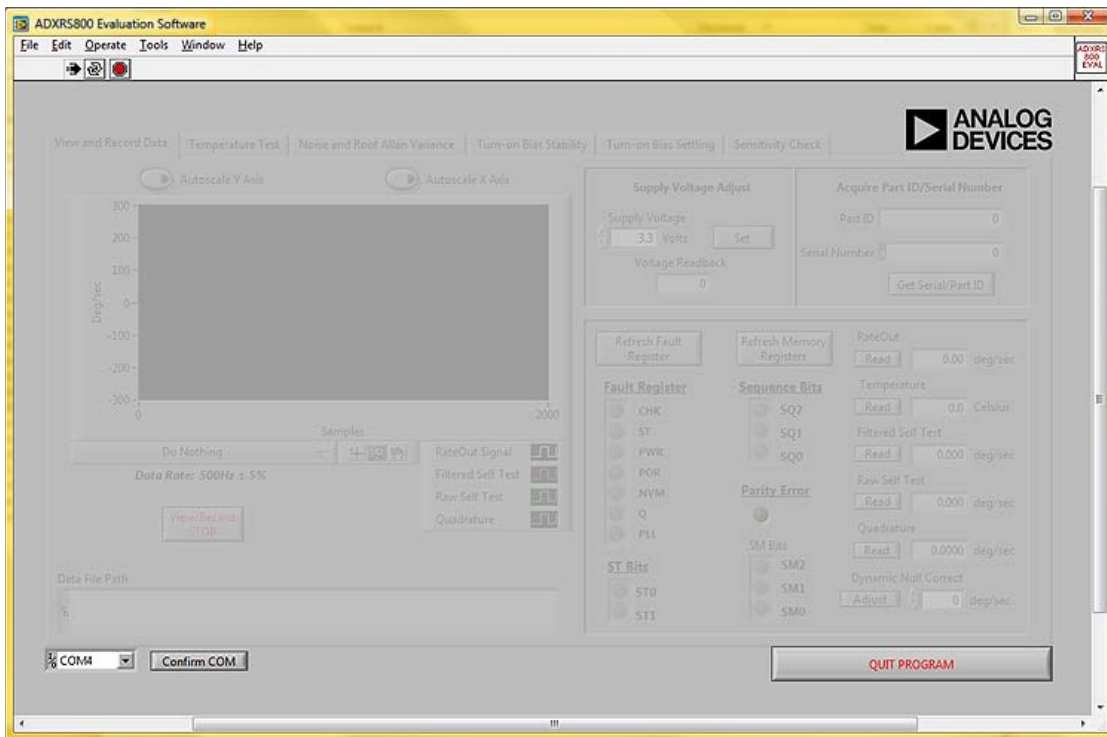

Figure 17. ADXRS800 Evaluation GUI Startup

Before running the software evaluation GUI, it is a good idea to reset the ISEB by pressing the SW2 button described in the Installing the Latest ISEB Firmware section. This removes any errors that may be lingering due to an improper shutdown or disconnection from the PC.

After completion of the software GUI installation routine, a shortcut to launch the executable is added to the **Start** menu. To launch the evaluation GUI, click **Start/All Programs/ADXRS800 Evaluation Software/ADXRS800 Eval**. A window similar to the one shown in Figure 17 is displayed.

At this point, the functionality of the GUI is completely deactivated. Before testing any devices, you must associate the software GUI with the previously installed hardware through the COM port. See **PC Device Manager** under the **Ports (COM & LTP)** submenu to determine which COM port is assigned to the Analog Devices inertial sensor evaluation system. Select this COM port from the drop-down menu, and click **Confirm COM** to begin using the GUI.

After the COM port is confirmed, the full functionality of the software evaluation GUI is available for you to use. The following sections describe the purpose of each panel of the GUI. You can exit the GUI at any time by clicking **QUIT PROGRAM** located in the lower right of the startup window.

Note that you should not press the reset button (SW2) while the GUI is running. This causes the ISEB and the software GUI to lose sync and also causes the evaluation system to no longer function properly. Additionally, if for any reason the ISEB board and the software evaluation GUI do not appear to be properly communicating, you should perform the following reset routine:

1. Close the software GUI by clicking the **QUIT PROGRAM** or by selecting **File/Exit**.
2. When the software GUI is closed, reset the ISEB evaluation board by pressing the reset button (SW2).
3. Restart the software GUI.

VIEW AND RECORD DATA PANEL



Figure 18. View and Record Data Panel

The **View and Record Data** panel is the primary panel for interacting with the device. The drop-down box, located beneath the graph, contains the following three options:

- **Do Nothing** (the default option)
- **View Gyro Signals**
- **Record Gyro Signals**

Clicking **View Gyro Signals** obtains the **Rateout Signal**, **Filtered Self Test**, **Raw Self Test**, and **Quadrature** information from the device and plots all four signals simultaneously. As indicated by the GUI, the data rate at which this information is obtained is 500 Hz \pm 5%. The data rate is hardware controlled so that it remains constant regardless of the priority and processor load assigned to the software GUI by the operating system. For more information on the significance of the plotted signals, see the ADXRS800 data sheet.

Clicking **Record Gyro Signals** performs the same basic function as **View Gyro Signals**; however, it allows you to continuously stream the data to a .txt file. This is useful for recording the response of the part during short term events of less than ~2 minutes. This also ensures that the resulting data file is manageable across most data analysis software packages. You can perform the record functionality indefinitely.

Secondary information that is transmitted along with the plotted signals is graphically represented. This includes the fault register, sequence bits, status bits, and sensor module bits. This information is described in detail in the ADXRS800 data sheet. This information is also recorded alongside the plotted signals when you select **Record Gyro Signals**.

Additional functionality on this panel includes the ability to change the supply voltage, read the device ID and serial number, read the individual memory registers, and perform offset adjustments to zero out any residual offset. These options encompass the majority of the functionality of the ADXRS800 gyroscope.

Adjusting the Supply Voltage

The ADXRS800 is designed to operate over the full voltage range of 3.3 V to 5 V (\pm 5%). The device is designed to offer equivalent performance regardless of the voltage level available in the application. The numeric control allows you to adjust the voltage to reflect the voltage level available in your application. Clicking the **Set** button updates the voltage supplied to the ADXRS800 satellite board. The **Voltage Readback** field accurately displays the satellite supply voltage, which may be slightly different from the value in the numeric control.

TEMPERATURE TEST PANEL

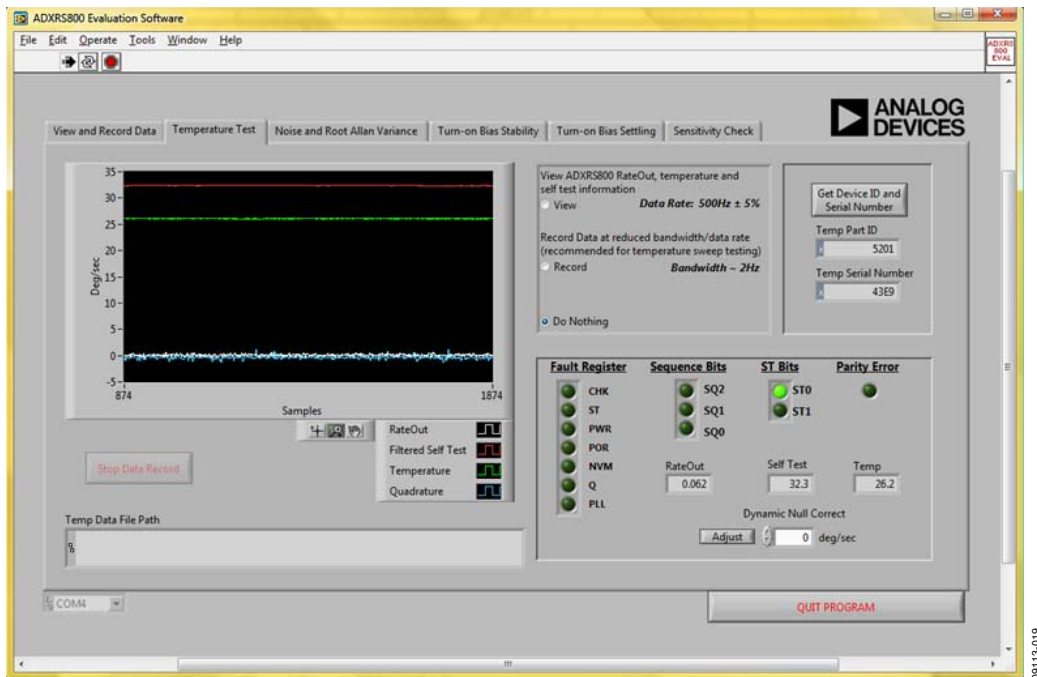

Figure 19. Temperature Test Panel

The **Temperature Test** panel is designed to let you easily perform long-term testing at a reduced bandwidth and data rate. The panel is specifically designed for temperature testing, with the on-board temperature sensor output plotted alongside the device rateout, filtered self-test, and quadrature. Each data point comprises an average of 250 samples, gathered at a 500 Hz data rate, resulting in a 2 Hz data rate from the device. You can view and record this information in much the same way as on the **View and Record** panel. Data is, again, streamed to a file to allow for an indefinite length for data recording.

Before recording the data on this panel, you can adjust for null offset components. Note that any offset correction made to the ADXRS800 is stored in the device EEPROM indefinitely or until overwritten with a subsequent correction value. Any null offset corrections made on the **View and Record Data** panel persist throughout the evaluation GUI system even when the device is power cycled.

Supplemental information, including the fault register, sequence bits, and status bits, is graphically displayed and recorded in addition to the plotted information you choose to record.

NOISE AND ROOT ALLAN VARIANCE PANEL

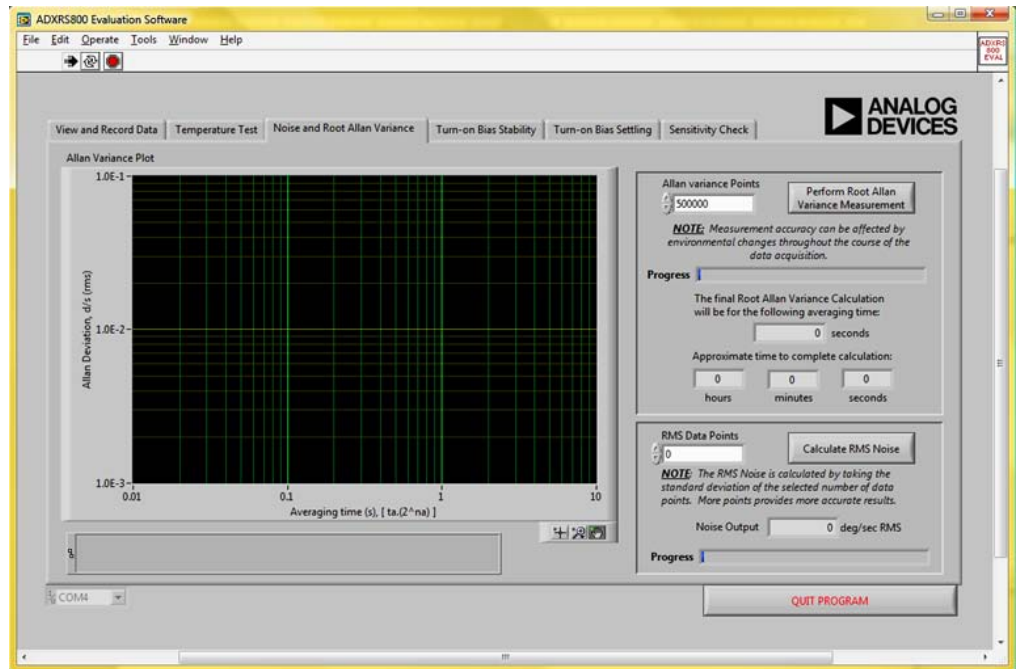

Figure 20. Noise and Root Allan Variance Panel

The software GUI includes the ability to calculate and plot the root Allan variance (RAV) of the ADXRS800. Root Allan variance can be approximately described as the variation of successive long-term averages of the null output of the ADXRS800. This is usually reported in units of degrees per hour and indicates the long-term bias stability of a gyroscope. To generate an accurate root Allan variance plot, it is recommended that this test be run (at least) overnight, during which time care should be taken to ensure that the device is in a temperature-stable, and disturbance-free environment. Any

rotational rate input into the gyroscope can greatly degrade the validity of the resulting RAV plot.

Determining the rms noise of the ADXRS800 can be done on this same panel. The evaluation GUI calculates the rms noise by taking the standard deviation of the specified number of points, which is roughly equivalent to the 1 sigma peak-to-peak noise value. These data points are obtained at a 500 Hz data rate. It is recommended that you perform this test with at least 16,000 data points to obtain accurate results. Fewer data points can be used, but the reported rms noise is then subject to higher variability.

TURN-ON BIAS STABILITY PANEL

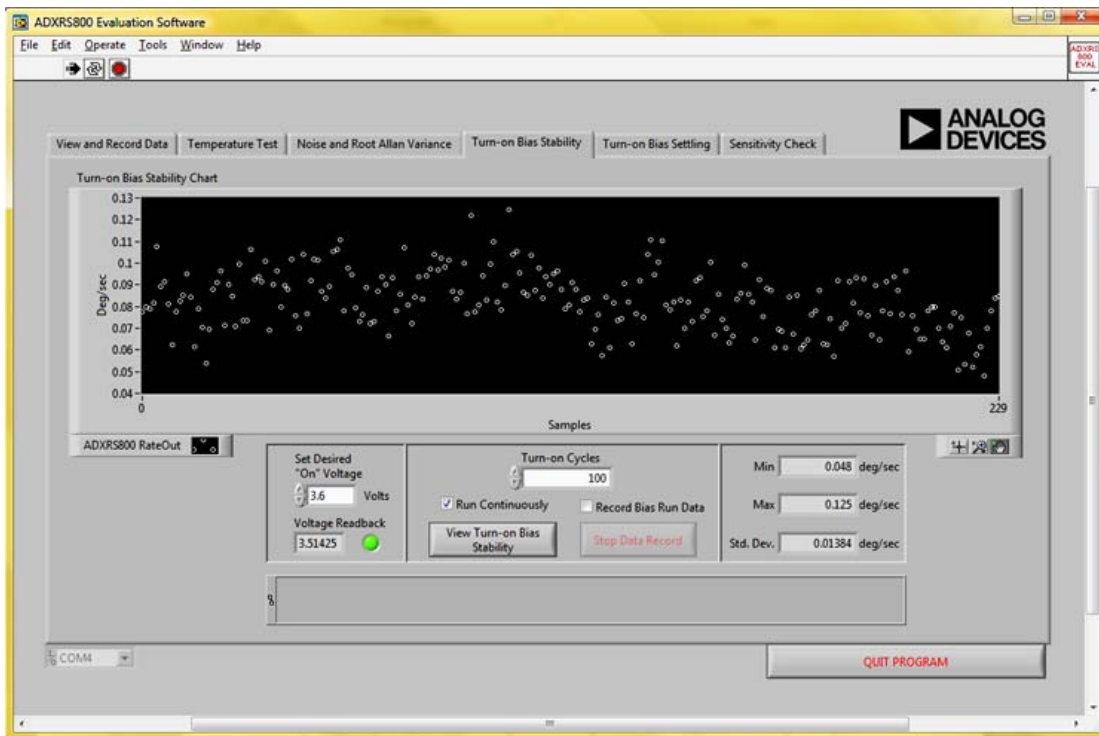

Figure 21. Turn-On Bias Stability Panel

Another key performance characteristic of gyroscopes is their turn-on to turn-on bias stability, which determines the range of expected offset values between each power cycle that can be factored into the development of application specific algorithms.

The **Turn-on Bias Stability** panel allows you to adjust the supply voltage for this test to match the intended application voltage. To record the data from this panel, ensure that the **Record Bias Run Data** box is checked before clicking the **View Turn-on Bias Stability** button. You are then prompted to enter

a file name for the data upon completion of the specified number of turn-on cycles or upon clicking the **Stop Data Record** button. While the test is running, the **Min**, **Max**, and **Std Dev.** boxes are updated upon the completion of each power cycle.

Like the root Allan variance procedure, it is recommended that this test be run for several hours and in a temperature-stable and disturbance-free environment. Any rotational motion applied to the gyro corrupts the results of this experiment.

TURN-ON BIAS SETTLING PANEL

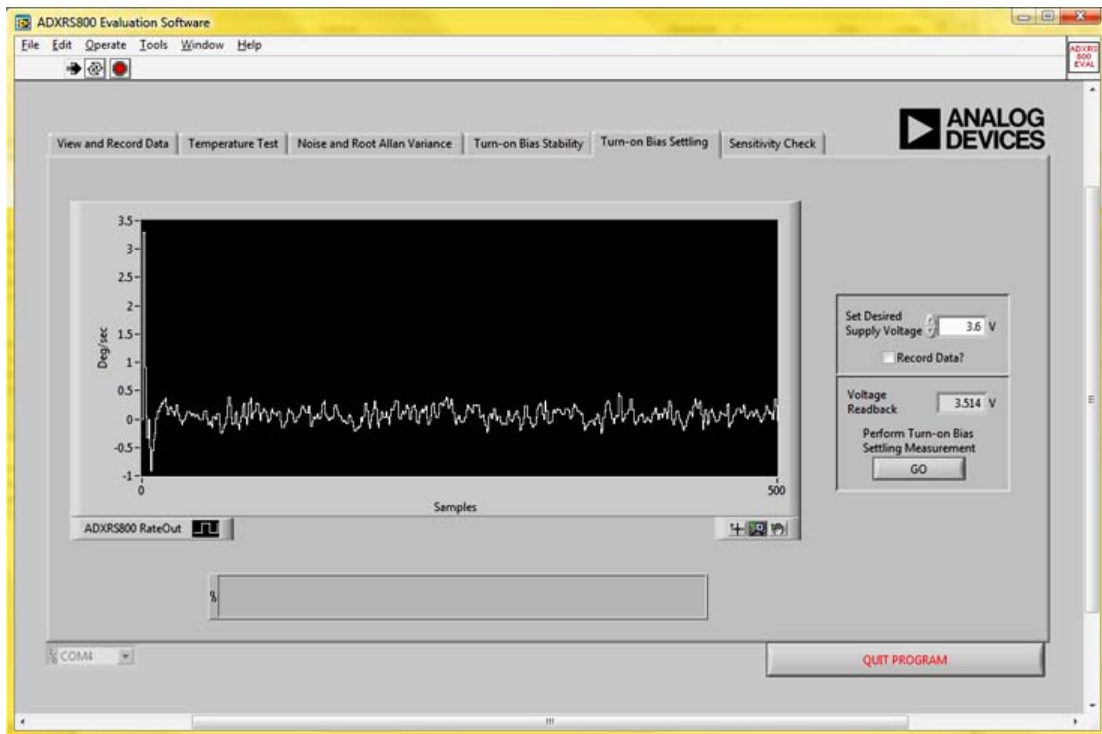

Figure 22. Turn-On Bias Settling

In addition to the bias stability from one power cycle to the next, it is important to understand the device behavior at the moment power is applied to the device. The recommended turn-on time for the ADXR5800 is 100 ms (typical), and it is not recommended that your applications try to obtain accurate rate data from the device within this period. However, if it is not possible to control the communications timings such that the application does not communicate with the device before 100 ms expires, this panel allows you to observe the turn-on behavior of the ADXR5800 for incorporation into your system's algorithms.

For this test panel, the first SPI message is typically received from the device within 20 ms after the ISEB supplies power to the satellite board.

Additionally, if the device is rotated at a constant rate while power is applied, the **Turn-on Bias Settling** panel (see Figure 22) verifies that the conditions defined for the turn-on time are achieved; that is, after 100 ms (typical), the device output is within 1% or $\frac{1}{2}^\circ/\text{sec}$ of the applied rotational rate, whichever comes first.

SENSITIVITY CHECK PANEL

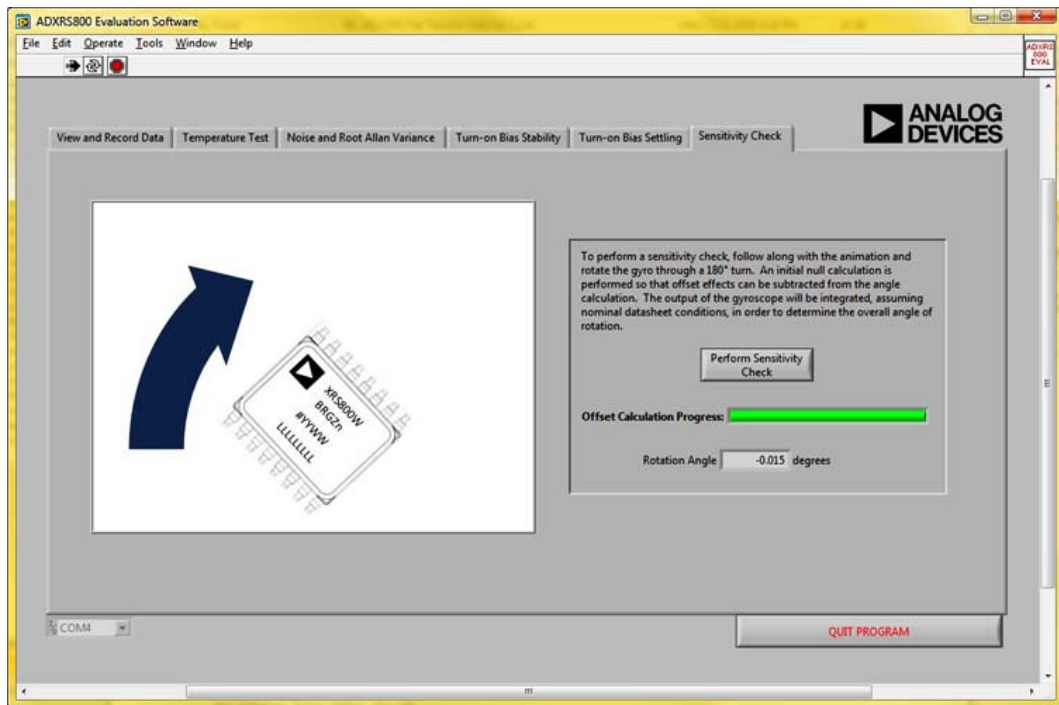

Figure 23. Sensitivity Check Panel

The last panel (see Figure 23) provides a method for checking the approximate sensitivity of a given device. The data sheet specification for sensitivity is $80 \pm 3\%$ LSBs/ $^{\circ}$ /sec. This panel is designed to use the nominal sensitivity to calculate the angle of rotation experienced by the satellite board. If you have access to a firmly rooted straight edge, you can use the **Sensitivity Check** panel as follows:

1. Place a flat edge of the satellite board firmly against the desktop straight edge.
2. Click the **Perform Sensitivity Check** button. Do not rotate the satellite board until instructed by the evaluation GUI. The software must perform an initial calibration step to accurately calculate the angle of rotation.
3. After the null calibration is performed, slowly rotate the satellite board through 180° (90° can also be used). Because the satellite board is approximately square, as each adjacent side is brought flush with the straight edge, 90° of rotation will have been experienced. After the gyro graphic in the GUI rotates through 180° , the measurement stops.
4. If you finish rotating the device before completion of the measurement, firmly hold the satellite board against the straight edge to ensure that no additional rotation is applied to the device.

At the completion of the measurement, the angle through which the satellite board was rotated should appear in the GUI. This measurement should be considered approximate because error sources incurred during the angle integration can alter the results.

ALTERNATE EXTERNAL HIGH VOLTAGE SUPPLY

As discussed in the COM Port Verification section, and shown again in Figure 24, the default jumper positions configure the part to use an on-board boost converter to generate a high voltage (approximately 24 V) input signal. This boost converter is supported through circuitry internal to the ADXRS800 and requires an external inductor and a diode for proper operation. See the ADXRS800 data sheet for a full description of the boost converter operation.

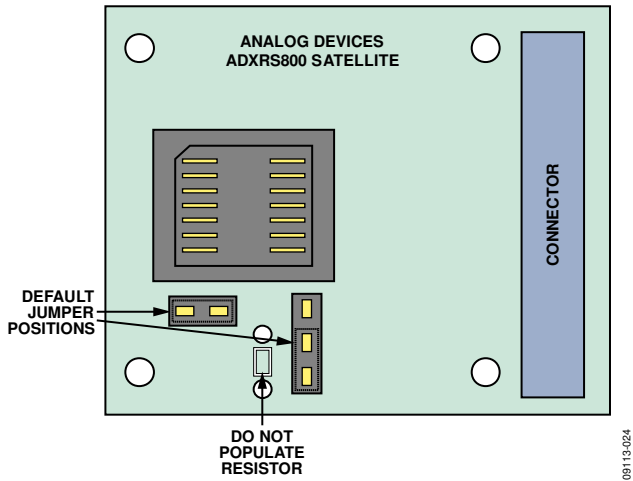

Figure 24. Default Jumper Configuration

If the end application has an external high voltage supply available, and you want to omit the inductor and diode, you can modify the satellite board to accept this supply. Figure 25 shows the required jumper configuration when using an external high voltage supply. Additionally, a footprint for a through-hole resistor has been included. This resistor must be populated such that, when combined with the high voltage supply, the proper current is sourced to the ADXRS800.

The supply requirements are described in detail in the ADXRS800 data sheet. The main requirement for the external high voltage supply is that 0.1 mA to 1mA of current be supplied to the device. The nominal internal voltage is 22.5 V.

As an example, assume that a 30 V supply is available in the end application. Then 22.5 V (typical) is required internally, and 30 V is available externally. For this condition, 7.5 V is dropped across the external resistor. To ensure that between 0.1 mA and 1 mA of current is sourced, a 12 kΩ resistor can be chosen. This sources 0.625 mA to the ADXRS800.

You can then test the satellite board in exactly the same way as described throughout this user guide and be able to verify that your external supply meets the requirements of the ADXRS800, accounting for supply tolerances and temperature effects.

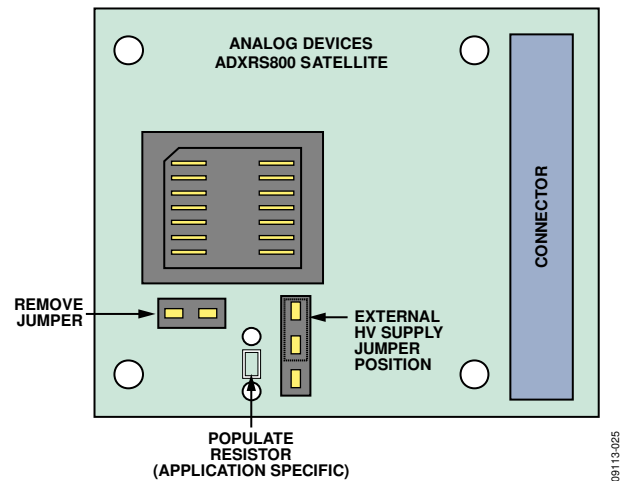

Figure 25. Jumper Configuration for External High Voltage Supply

HEADER PINOUT

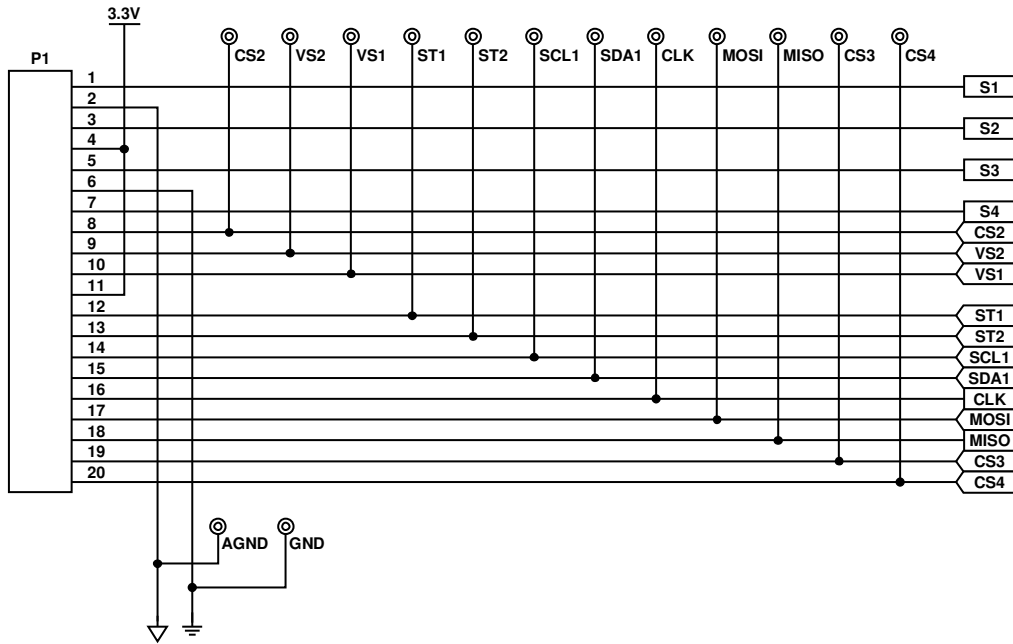

Figure 26. ISEB 20-Pin Header Pinout

09113-013



ESD Caution

ESD (electrostatic discharge) sensitive device. Charged devices and circuit boards can discharge without detection. Although this product features patented or proprietary protection circuitry, damage may occur on devices subjected to high energy ESD. Therefore, proper ESD precautions should be taken to avoid performance degradation or loss of functionality.

Legal Terms and Conditions

By using the evaluation board discussed herein (together with any tools, components documentation or support materials, the "Evaluation Board"), you are agreeing to be bound by the terms and conditions set forth below ("Agreement") unless you have purchased the Evaluation Board, in which case the Analog Devices Standard Terms and Conditions of Sale shall govern. Do not use the Evaluation Board until you have read and agreed to the Agreement. Your use of the Evaluation Board shall signify your acceptance of the Agreement. This Agreement is made by and between you ("Customer") and Analog Devices, Inc. ("ADI"), with its principal place of business at One Technology Way, Norwood, MA 02062, USA. Subject to the terms and conditions of the Agreement, ADI hereby grants to Customer a free, limited, personal, temporary, non-exclusive, non-sublicensable, non-transferable license to use the Evaluation Board FOR EVALUATION PURPOSES ONLY. Customer understands and agrees that the Evaluation Board is provided for the sole and exclusive purpose referenced above, and agrees not to use the Evaluation Board for any other purpose. Furthermore, the license granted is expressly made subject to the following additional limitations: Customer shall not (i) rent, lease, display, sell, transfer, assign, sublicense, or distribute the Evaluation Board; and (ii) permit any Third Party to access the Evaluation Board. As used herein, the term "Third Party" includes any entity other than ADI, Customer, their employees, affiliates and in-house consultants. The Evaluation Board is NOT sold to Customer; all rights not expressly granted herein, including ownership of the Evaluation Board, are reserved by ADI. CONFIDENTIALITY. This Agreement and the Evaluation Board shall all be considered the confidential and proprietary information of ADI. Customer may not disclose or transfer any portion of the Evaluation Board to any other party for any reason. Upon discontinuation of use of the Evaluation Board or termination of this Agreement, Customer agrees to promptly return the Evaluation Board to ADI. ADDITIONAL RESTRICTIONS. Customer may not disassemble, decompile or reverse engineer chips on the Evaluation Board. Customer shall inform ADI of any occurred damages or any modifications or alterations it makes to the Evaluation Board, including but not limited to soldering or any other activity that affects the material content of the Evaluation Board. Modifications to the Evaluation Board must comply with applicable law, including but not limited to the RoHS Directive. TERMINATION. ADI may terminate this Agreement at any time upon giving written notice to Customer. Customer agrees to return to ADI the Evaluation Board at that time. LIMITATION OF LIABILITY. THE EVALUATION BOARD PROVIDED HEREUNDER IS PROVIDED "AS IS" AND ADI MAKES NO WARRANTIES OR REPRESENTATIONS OF ANY KIND WITH RESPECT TO IT. ADI SPECIFICALLY DISCLAIMS ANY REPRESENTATIONS, ENDORSEMENTS, GUARANTEES, OR WARRANTIES, EXPRESS OR IMPLIED, RELATED TO THE EVALUATION BOARD INCLUDING, BUT NOT LIMITED TO, THE IMPLIED WARRANTY OF MERCHANTABILITY, TITLE, FITNESS FOR A PARTICULAR PURPOSE OR NON-INFRINGEMENT OF INTELLECTUAL PROPERTY RIGHTS. IN NO EVENT WILL ADI AND ITS LICENSORS BE LIABLE FOR ANY INCIDENTAL, SPECIAL, INDIRECT, OR CONSEQUENTIAL DAMAGES RESULTING FROM CUSTOMER'S POSSESSION OR USE OF THE EVALUATION BOARD, INCLUDING BUT NOT LIMITED TO LOST PROFITS, DELAY COSTS, LABOR COSTS OR LOSS OF GOODWILL. ADI'S TOTAL LIABILITY FROM ANY AND ALL CAUSES SHALL BE LIMITED TO THE AMOUNT OF ONE HUNDRED US DOLLARS (\$100.00). EXPORT. Customer agrees that it will not directly or indirectly export the Evaluation Board to another country, and that it will comply with all applicable United States federal laws and regulations relating to exports. GOVERNING LAW. This Agreement shall be governed by and construed in accordance with the substantive laws of the Commonwealth of Massachusetts (excluding conflict of law rules). Any legal action regarding this Agreement will be heard in the state or federal courts having jurisdiction in Suffolk County, Massachusetts, and Customer hereby submits to the personal jurisdiction and venue of such courts. The United Nations Convention on Contracts for the International Sale of Goods shall not apply to this Agreement and is expressly disclaimed.

