



Chipsmall Limited consists of a professional team with an average of over 10 year of expertise in the distribution of electronic components. Based in Hongkong, we have already established firm and mutual-benefit business relationships with customers from,Europe,America and south Asia,supplying obsolete and hard-to-find components to meet their specific needs.

With the principle of "Quality Parts,Customers Priority,Honest Operation,and Considerate Service",our business mainly focus on the distribution of electronic components. Line cards we deal with include Microchip,ALPS,ROHM,Xilinx,Pulse,ON,Everlight and Freescale. Main products comprise IC,Modules,Potentiometer,IC Socket,Relay,Connector.Our parts cover such applications as commercial,industrial, and automotives areas.

We are looking forward to setting up business relationship with you and hope to provide you with the best service and solution. Let us make a better world for our industry!



Contact us

Tel: +86-755-8981 8866 Fax: +86-755-8427 6832

Email & Skype: info@chipsmall.com Web: www.chipsmall.com

Address: A1208, Overseas Decoration Building, #122 Zhenhua RD., Futian, Shenzhen, China



Evaluation Board for SSM2375 Filterless Class-D Audio Amplifier

PACKAGE CONTENTS

EVAL-SSM2375Z evaluation board

OTHER SUPPORTING DOCUMENTATION

[SSM2375 data sheet](#)

GENERAL DESCRIPTION

The SSM2375 is a fully integrated, high efficiency, Class-D audio amplifier. It is designed to maximize performance for mobile phone applications. The application circuit requires a minimum of external components and operates from a single 2.5 V to 5.5 V supply. It is capable of delivering 3 W of continuous output power with less than 1% THD + N driving a 3 Ω load from a 5.0 V supply.

Spread spectrum pulse density modulation (PDM) is used to provide lower EMI-radiated emissions compared with other Class-D architectures. The inherent randomized nature of spread spectrum PDM eliminates clock intermodulation (beating effect) of several amplifiers in close proximity. The SSM2375 includes an optional modulation select pin that

enables a low EMI mode, which significantly reduces the radiated emissions at the Class-D outputs, particularly above 100 MHz. With this option selected, the SSM2375 can pass FCC Class B radiated emissions testing with a 50 cm unshielded speaker cable without any external filtering.

The device also includes a flexible gain select pin that only requires one series resistor to select among 0 dB, 3 dB, 6 dB, 9 dB, or 12 dB. The benefit of this is to improve gain matching between multiple SSM2375 devices within a single application as compared to using external resistors to set gain. This user guide describes how to configure and use the SSM2375 evaluation board. It is recommended that this user guide be read in conjunction with the SSM2375 data sheet, which provides specifications, internal block diagrams, and application guidance for the amplifier IC.

EVALUATION BOARD OVERVIEW

The SSM2375 evaluation board carries a complete application circuit for driving a loudspeaker. Figure 1 shows the top view of the evaluation board, and Figure 2 shows the bottom view.

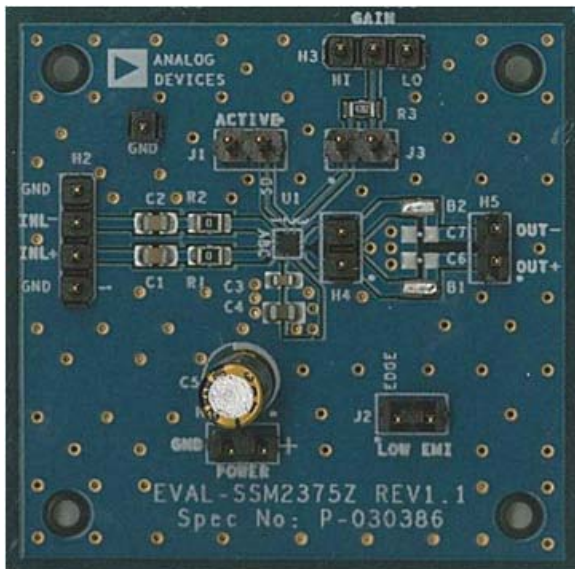

Figure 1. SSM2375 Evaluation Board Top View



Figure 2. SSM2375 Evaluation Board Bottom View

TABLE OF CONTENTS

Package Contents.....	1	Output Configuration.....	3
Other Supporting Documentation.....	1	Power Supply Configuration	3
General Description	1	Component Selection	3
Evaluation Board Overview	1	Getting Started.....	5
Revision History	2	What to Test	5
Setting Up the Evaluation Board	3	Evaluation Board Schematic and Artwork.....	6
Input Configuration	3	Ordering Information.....	8
Shutdown Mode.....	3	Bill of Materials.....	8
Gain Configuration.....	3		

REVISION HISTORY

4/11—Revision 0: Initial Version

SETTING UP THE EVALUATION BOARD

INPUT CONFIGURATION

A 4-pin header (H2) on the middle left side of the board feeds the audio signal into the board (see Figure 1). If the input audio signal is differential (IN+ and IN–), three pins of H2 are used for IN+, IN–, and signal ground. For a single-ended audio input, only two pins of H2 are used. One is for the signal ground and the other is for either IN+ or IN–. If IN+ is used, place a jumper between Pin 3 and Pin 4 of H2, shorting IN– to ground. If IN– is used, place the jumper between Pin 1 and Pin 2 of H2, connecting IN+ to ground.

SHUTDOWN MODE

The 2-pin header, J1, is used to turn on and off the SSM2375 amplifier. Placing a jumper across Pin 1 and Pin 2 of H1 puts the SSM2375 in normal operation. Removing the jumper shuts down the SSM2375 so that only a minimum current (about 20 nA) is drawn from the power supply.

GAIN CONFIGURATION

Two headers, H3 and J3, control the SSM2375 analog gain. By placing a jumper across two pins of H3, the amplifier's gain pin can be connected to GND or VDD. Three jumper settings are used: between the center pin and the left pin (HI), between the center pin and the right pin (LO), and no jumper (open).

Placing a jumper on J3 removes the 47 kΩ resistor (R3) between the gain pin and H3. Gain settings between 0 dB and 12 dB are available; see Table 1 for configuration details.

Table 1. Gain Configuration

Gain	J3	H3	Configuration
0 dB	Short	LO	Short gain pin to GND
3 dB	Short	Open	Gain pin unconnected
6 dB	Short	HI	Short gain pin to VDD
9 dB	Open	LO	Gain pin through 47 kΩ to GND
12 dB	Open	HI	Gain pin through 47 kΩ to VDD

OUTPUT CONFIGURATION

The output connector, H4, is located on the right side of the board (see Figure 1). H4 can drive a loudspeaker whose impedance should be no less than 3 Ω.

Because the SSM2375 does not typically require any external LC output filters due to a low noise modulation scheme, no output filter is installed on the evaluation board. In this case, thick wire connects the empty pads of B1 and B2, and the capacitor pads are left unpopulated.

If the speaker length exceeds 10 cm, place Ferrite Bead B1 and Ferrite Bead B2 in the output paths, and use Capacitors C6 and C7 to couple the output terminals to ground, as shown in the schematic in Figure 3. Some recommended ferrite beads are listed in Table 2. Some users may want to use inductors for applications with specific EMI vs. audio performance constraints; see Table 3 for recommendations.

For optimal THD and SNR performance as specified in the SSM2375 data sheet, remove the entire EMI filter, short across the ferrite bead terminals, and open the capacitor terminals.

POWER SUPPLY CONFIGURATION

The 2-pin header, H1, is used to power the board. Care must be taken to connect the dc power with correct polarity and voltage. Reverse polarity or overvoltage may damage the board permanently. The maximum supply current is approximately 0.33 A when driving an 8 Ω load and when the input voltage is 5 V. Do not allow VDD to exceed 5.5 V.

COMPONENT SELECTION

Selecting the proper components is the key to achieving the performance required at the cost budgeted.

Input Gain Resistor Selection—R1 and R2

If the desired gain must be adjusted beyond the available gain settings (see the Gain Configuration section), a series resistor can be placed in the input signal path. This creates a voltage divider with the 80 kΩ input resistance on each input pin, allowing an arbitrary reduction of the input signal. Note that input signal attenuation directly reduces SNR performance; therefore, large values compared to the built-in input resistance should be avoided. These components are populated with 0 Ω values on the evaluation board.

Input Coupling Capacitor Selection—C1 and C2

The input coupling capacitors, C1 and C2, should be large enough to couple the low frequency signal components in the incoming signal but small enough to reject unnecessary extremely low frequency signals. For music signals, the cutoff frequency is typically between 20 Hz and 30 Hz. The value of the input capacitor is calculated by

$$C = 1/(2\pi R_{IN} f_c)$$

where:

$$R_{IN} = 80 \text{ k}\Omega + (R1 \text{ or } R2).$$

f_c is the desired cutoff frequency.

Output Ferrite Beads—B1 and B2

The output beads, B1 and B2, are necessary components for filtering out the EMI caused at the switching output nodes when the length of the speaker wire is greater than 10 cm. The penalty for using ferrite beads for EMI filtering is slightly worse noise and distortion performance at the system level due to the nonlinearity of the beads.

Ensure that these beads have enough current conducting capability while providing sufficient EMI attenuation. The current rating needed for an 8 Ω load is approximately 420 mA, and impedance at 100 MHz should be $\geq 120 \Omega$. In addition, the lower the dc resistance (DCR) of these beads, the better for minimizing their power consumption. Table 2 describes the recommended beads.

Output Shunting Capacitors

There are two output-shunting capacitors, C6 and C7, that work with the ferrite beads, B1 and B2. Use small size (0603 or 0402), multilayer ceramic capacitors made of X7R or C0G (NP0) materials. Note that the capacitors can be used in pairs: a capacitor with small capacitance (up to 100 pF) plus a capacitor with a larger capacitance (less than 1 nF). This configuration provides thorough EMI reduction for the entire frequency spectrum. If the bill of materials must be minimized, a single capacitor of approximately 470 pF can be used with acceptable performance in many cases.

Output Inductors

If inductors are preferred for EMI filtering at the output nodes, choose components with an inductance of less than 2.2 μH . The higher the inductance, the lower the EMI is at the output; however, cost and power consumption are higher. Using 0.47 μH to 2.2 μH inductors is recommended, and the current rating (and saturation current) should exceed 600 mA for an 8 Ω load. Table 3 shows the recommended inductors.

Table 2. Recommended Output Beads

Part No.	Manufacturer	Z (Ω)	I _{MAX} (mA)	DCR (Ω)	Size (mm)
BLM18PG121SN1D	Murata	120	2000	0.05	1.6 × 0.8 × 0.8
MPZ1608S101A	TDK	100	3000	0.03	1.6 × 0.8 × 0.8
MPZ1608S221A	TDK	220	2000	0.05	1.6 × 0.8 × 0.8
BLM18EG221SN1D	Murata	220	2000	0.05	1.6 × 0.8 × 0.8

Table 3. Recommended Output Inductors

Part No.	Manufacturer	L (μH)	I _{MAX} (mA)	DCR (Ω)	Size (mm)
LQM31PNR47M00	Murata	0.47	1400	0.07	3.2 × 1.6 × 0.85
LQM31PN1R0M00	Murata	1.0	1200	0.12	3.2 × 1.6 × 0.85
LQM21PNR47MC0	Murata	0.47	1100	0.12	2.0 × 1.25 × 0.5
LQM21PN1R0MC0	Murata	1.0	800	0.19	2.0 × 1.25 × 0.5
LQH32CN2R2M53	Murata	2.2	790	0.1	3.2 × 2.5 × 1.55

GETTING STARTED

To ensure proper operation, carefully follow Step 1 through Step 5.

1. Place a jumper between Pin 1 and Pin 2 of J1 to enable the amplifier.
2. For most audio quality testing, the EMI filtering (B1/B2 and C6/C7) must be removed. Short across the B1 and B2 terminals to make a direct connection from device output to the H5 speaker header.
3. Connect the load to the audio output connector, H5.
4. Connect the audio input to the board in either differential mode or single-ended mode, depending on the application.
5. Connect the power supply with the proper polarity and voltage.

WHAT TO TEST

- Electromagnetic interference (EMI)—connect wires for the speakers, making sure they are the same length as the wires required for the actual application environment; then complete the EMI test.
- Signal-to-noise ratio.
- Output noise—make sure to use an A-weighted filter to filter the output before reading the measurement meter.
- Maximum output power.
- Distortion.
- Efficiency.

EVALUATION BOARD SCHEMATIC AND ARTWORK

500-53850

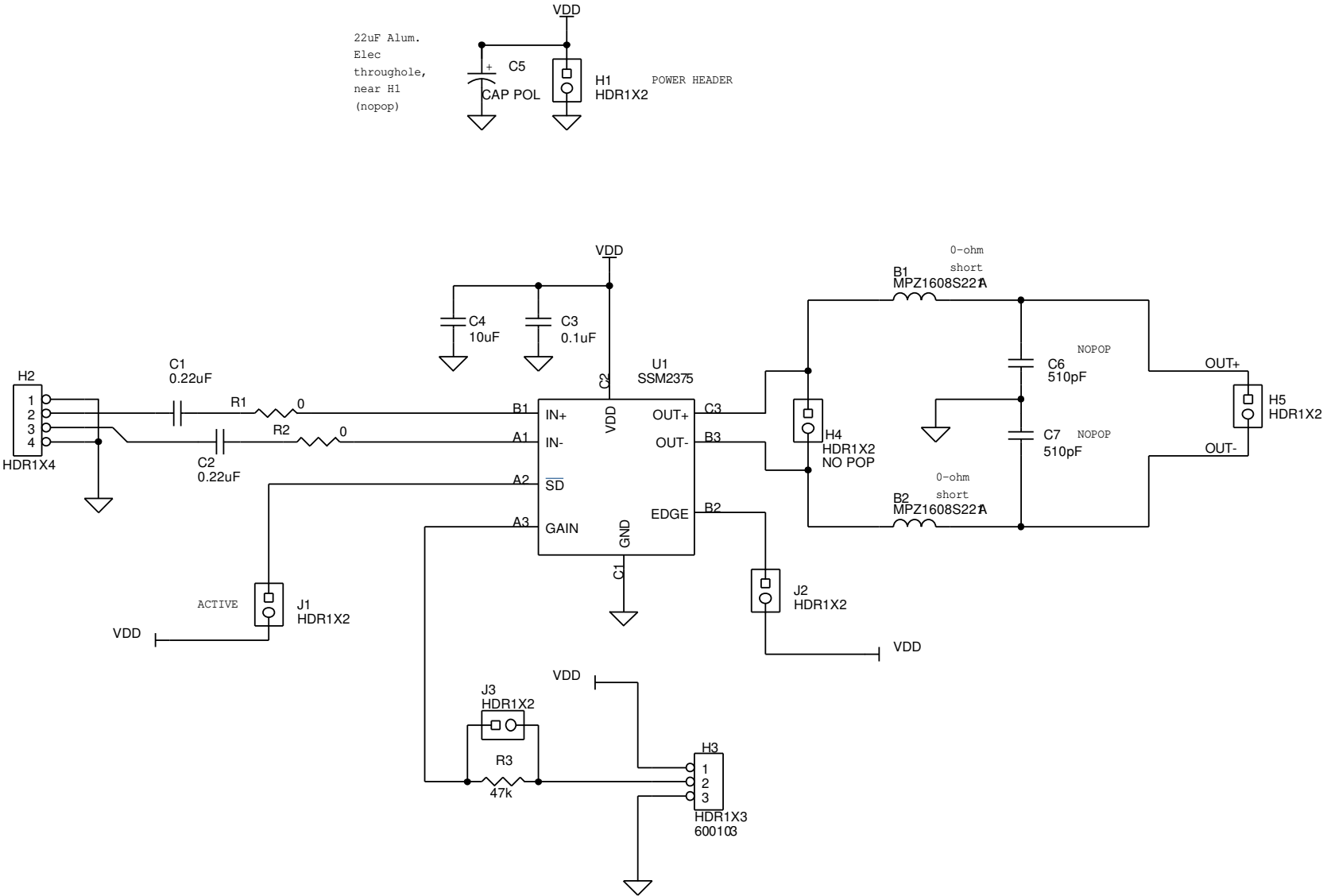
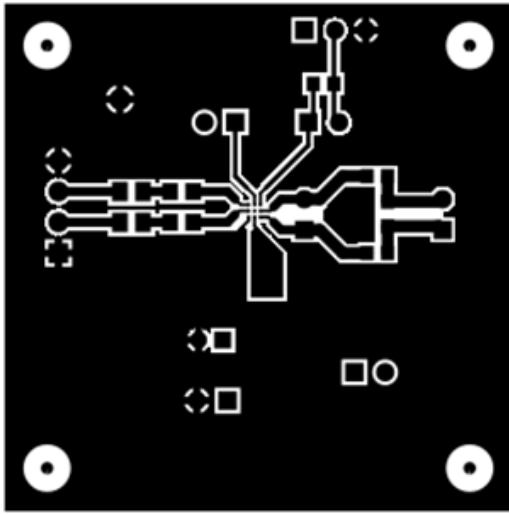
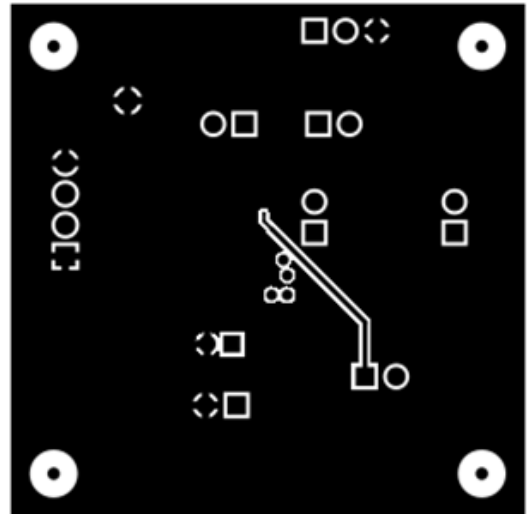

Figure 3. Schematic of the SSM2375 Evaluation Board
Rev. 0 | Page 6 of 8



08393-004

Figure 4. Top Layer Copper



08393-007

Figure 7. Bottom Layer Copper

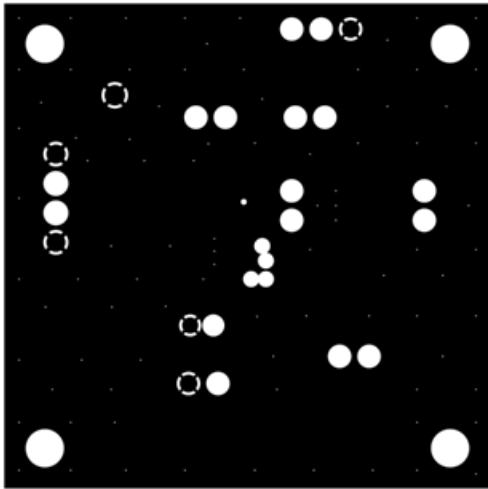

08393-005

Figure 5. Second Layer Copper—GND Plane

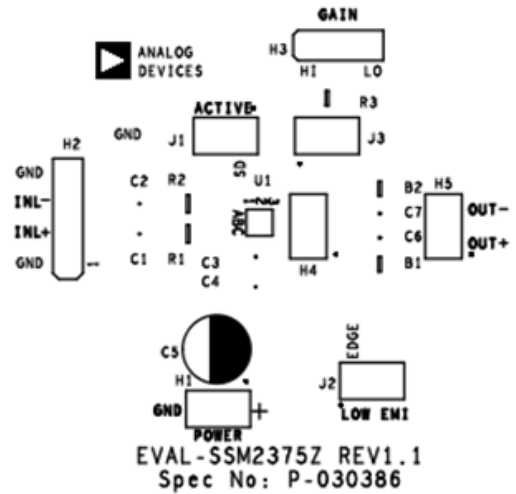

08393-008

Figure 8. Top Silkscreen

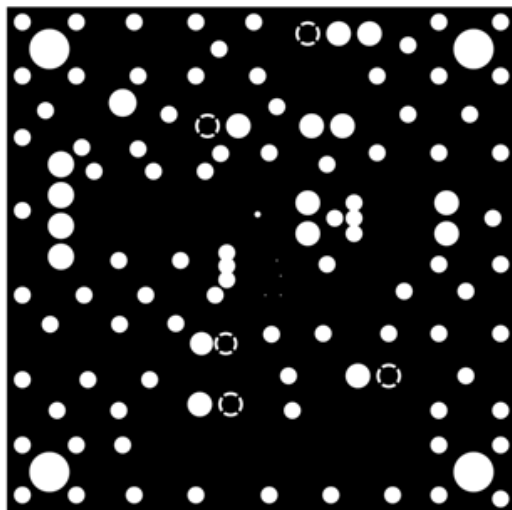

08393-006

Figure 6. Third Layer Copper—VDD Plane

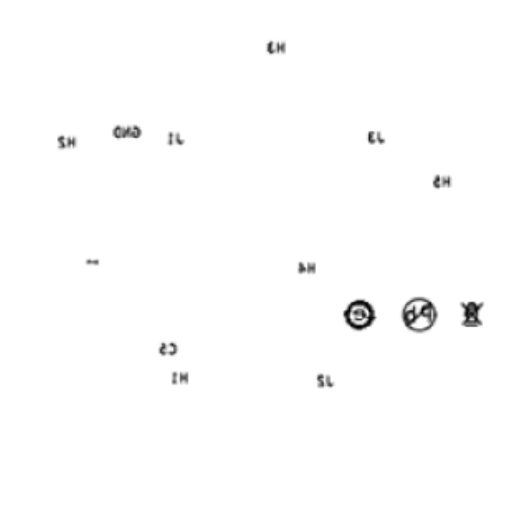

08393-009

Figure 9. Bottom Silkscreen

ORDERING INFORMATION

BILL OF MATERIALS

Table 4.

Qty	Reference Designator	Description	Supplier/Part No.
1	U1	IC, SSM2375	Analog Devices/SSM2375CBZ
2	C1, C2	Capacitor, 22 nF, 25 V, 10%, X7R, 0805	Panasonic/ECJ-2YB1E224K
1	C3	Capacitor, ceramic 0.1 μ F, 50 V, Y5V, 0603	Panasonic/ECJ-1VF1H104Z
1	C4	Capacitor, ceramic 10 μ F, 10 V, X5R, 0805	Murata/GRM21BR61A106KE19L
1	C5	Capacitor, 47 μ F, 25 V electrolytic	Nichicon/UFW1E470MDD
2	C6, C7	Capacitor, ceramic, 510 pF, 50 V, 2%, 0603	Murata/GRM1885C1H511JA01D
2	B1, B2	Wire short	N/A
2	R1, R2	Resistor, 0.0 Ω , 1/8 W, 0805	Panasonic/P0.0ATR-ND
1	R3	Resistor, 47 k Ω , 1/10 W, 1%, 0603	Panasonic/ERJ-3EKF4702V
6	H1, H4, H5, J1 to J3	Connector, header, 2-position, 0.100" single gold	Tyco/826629-2
1	H2	Connector, header, 4-position, 0.100" single gold	Tyco/826629-3
1	H3	Connector, header, 3-position, 0.100" single gold	Tyco/826629-4

**ESD Caution**

ESD (electrostatic discharge) sensitive device. Charged devices and circuit boards can discharge without detection. Although this product features patented or proprietary protection circuitry, damage may occur on devices subjected to high energy ESD. Therefore, proper ESD precautions should be taken to avoid performance degradation or loss of functionality.

Legal Terms and Conditions

By using the evaluation board discussed herein (together with any tools, components documentation or support materials, the "Evaluation Board"), you are agreeing to be bound by the terms and conditions set forth below ("Agreement") unless you have purchased the Evaluation Board, in which case the Analog Devices Standard Terms and Conditions of Sale shall govern. Do not use the Evaluation Board until you have read and agreed to the Agreement. Your use of the Evaluation Board shall signify your acceptance of the Agreement. This Agreement is made by and between you ("Customer") and Analog Devices, Inc. ("ADI"), with its principal place of business at One Technology Way, Norwood, MA 02062, USA. Subject to the terms and conditions of the Agreement, ADI hereby grants to Customer a free, limited, personal, temporary, non-exclusive, non-sublicensable, non-transferable license to use the Evaluation Board FOR EVALUATION PURPOSES ONLY. Customer understands and agrees that the Evaluation Board is provided for the sole and exclusive purpose referenced above, and agrees not to use the Evaluation Board for any other purpose. Furthermore, the license granted is expressly made subject to the following additional limitations: Customer shall not (i) rent, lease, display, sell, transfer, assign, sublicense, or distribute the Evaluation Board; and (ii) permit any Third Party to access the Evaluation Board. As used herein, the term "Third Party" includes any entity other than ADI, Customer, their employees, affiliates and in-house consultants. The Evaluation Board is NOT sold to Customer; all rights not expressly granted herein, including ownership of the Evaluation Board, are reserved by ADI. CONFIDENTIALITY. This Agreement and the Evaluation Board shall all be considered the confidential and proprietary information of ADI. Customer may not disclose or transfer any portion of the Evaluation Board to any other party for any reason. Upon discontinuation of use of the Evaluation Board or termination of this Agreement, Customer agrees to promptly return the Evaluation Board to ADI. ADDITIONAL RESTRICTIONS. Customer may not disassemble, decompile or reverse engineer chips on the Evaluation Board. Customer shall inform ADI of any occurred damages or any modifications or alterations it makes to the Evaluation Board, including but not limited to soldering or any other activity that affects the material content of the Evaluation Board. Modifications to the Evaluation Board must comply with applicable law, including but not limited to the RoHS Directive. TERMINATION. ADI may terminate this Agreement at any time upon giving written notice to Customer. Customer agrees to return to ADI the Evaluation Board at that time. LIMITATION OF LIABILITY. THE EVALUATION BOARD PROVIDED HEREUNDER IS PROVIDED "AS IS" AND ADI MAKES NO WARRANTIES OR REPRESENTATIONS OF ANY KIND WITH RESPECT TO IT. ADI SPECIFICALLY DISCLAIMS ANY REPRESENTATIONS, ENDORSEMENTS, GUARANTEES, OR WARRANTIES, EXPRESS OR IMPLIED, RELATED TO THE EVALUATION BOARD INCLUDING, BUT NOT LIMITED TO, THE IMPLIED WARRANTY OF MERCHANTABILITY, TITLE, FITNESS FOR A PARTICULAR PURPOSE OR NON-INFRINGEMENT OF INTELLECTUAL PROPERTY RIGHTS. IN NO EVENT WILL ADI AND ITS LICENSORS BE LIABLE FOR ANY INCIDENTAL, SPECIAL, INDIRECT, OR CONSEQUENTIAL DAMAGES RESULTING FROM CUSTOMER'S POSSESSION OR USE OF THE EVALUATION BOARD, INCLUDING BUT NOT LIMITED TO LOST PROFITS, DELAY COSTS, LABOR COSTS OR LOSS OF GOODWILL. ADI'S TOTAL LIABILITY FROM ANY AND ALL CAUSES SHALL BE LIMITED TO THE AMOUNT OF ONE HUNDRED US DOLLARS (\$100.00). EXPORT. Customer agrees that it will not directly or indirectly export the Evaluation Board to another country, and that it will comply with all applicable United States federal laws and regulations relating to exports. GOVERNING LAW. This Agreement shall be governed by and construed in accordance with the substantive laws of the Commonwealth of Massachusetts (excluding conflict of law rules). Any legal action regarding this Agreement will be heard in the state or federal courts having jurisdiction in Suffolk County, Massachusetts, and Customer hereby submits to the personal jurisdiction and venue of such courts. The United Nations Convention on Contracts for the International Sale of Goods shall not apply to this Agreement and is expressly disclaimed.