



Chipsmall Limited consists of a professional team with an average of over 10 year of expertise in the distribution of electronic components. Based in Hongkong, we have already established firm and mutual-benefit business relationships with customers from,Europe,America and south Asia,supplying obsolete and hard-to-find components to meet their specific needs.

With the principle of “Quality Parts,Customers Priority,Honest Operation,and Considerate Service”,our business mainly focus on the distribution of electronic components. Line cards we deal with include Microchip,ALPS,ROHM,Xilinx,Pulse,ON,Everlight and Freescale. Main products comprise IC,Modules,Potentiometer,IC Socket,Relay,Connector.Our parts cover such applications as commercial,industrial, and automotives areas.

We are looking forward to setting up business relationship with you and hope to provide you with the best service and solution. Let us make a better world for our industry!



Contact us

Tel: +86-755-8981 8866 Fax: +86-755-8427 6832

Email & Skype: info@chipsmall.com Web: www.chipsmall.com

Address: A1208, Overseas Decoration Building, #122 Zhenhua RD., Futian, Shenzhen, China



GaAs pHEMT MMIC 4 WATT POWER AMPLIFIER WITH POWER DETECTOR, 9 - 12 GHz



Typical Applications

The HMC6741LS7 is ideal for:

- Point-to-Point Radios
- Point-to-Multi-Point Radios
- SATCOM
- Military & Space
- Marine Radar

Features

- High P1dB Output Power: +36 dBm
- High Psat Output Power: +38 dBm
- High Gain: 35 dB
- High Output IP3: +44 dBm
- Supply Voltage: Vdd = +7V @ 2400 mA
- 50 Ohm Matched Input/Output
- No external matching required

Functional Diagram

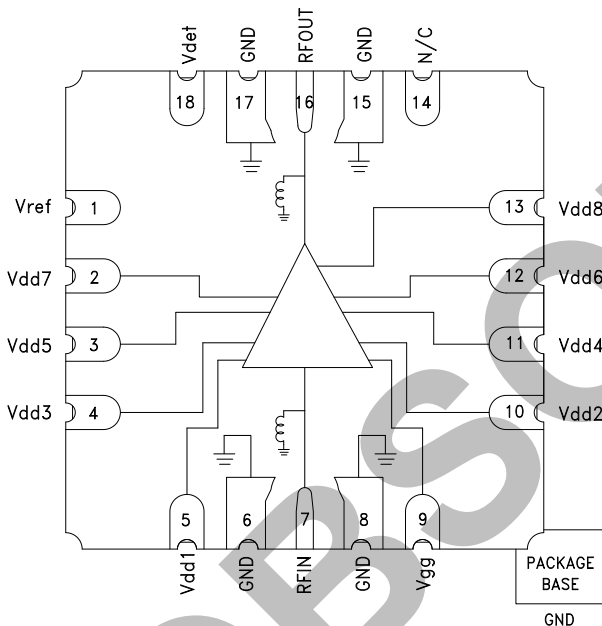

General Description

The HMC6741LS7 is a four stage GaAs pHEMT MMIC High Power Amplifier with a temperature compensated on chip power detector which operates between 9 and 13 GHz. The amplifier provides 35 dB of gain, +38 dBm of saturated output power, and 25% PAE from a +7V supply. With up to +44.5 dBm Output IP3. The HMC6741LS7 is ideal for high linearity applications in military and space applications as well as point-to-point and point-to-multi-point radios. The HMC6741LS7 amplifier I/Os are internally matched.

Electrical Specifications, $T_A = +25^\circ C$, Vdd1-8 = +7V, Idd = 2400 mA [1]

Parameter	Min.	Typ.	Max.	Min.	Typ.	Max.	Units
Frequency Range		9 - 10		10 - 12			GHz
Gain	32	35		31.5	34.5		dB
Gain Variation Over Temperature		0.056		0.058			dB/°C
Input Return Loss		23		16			dB
Output Return Loss		20		16			dB
Output Power for 1 dB Compression (P1dB)	32	35		33	36		dBm
Saturated Output Power (Psat)		37		38			dBm
Output Third Order Intercept (IP3) [2]		44		44.5			dBm
Total Supply Current		2400		2400			mA

[1] Adjust Vgg between -2 to 0V to achieve Idd = 2400 mA typical.

[2] Measurement taken at Pout / tone = +20 dBm.

GaAs pHEMT MMIC 4 WATT POWER AMPLIFIER WITH POWER DETECTOR, 9 - 12 GHz



Gain & Return Loss

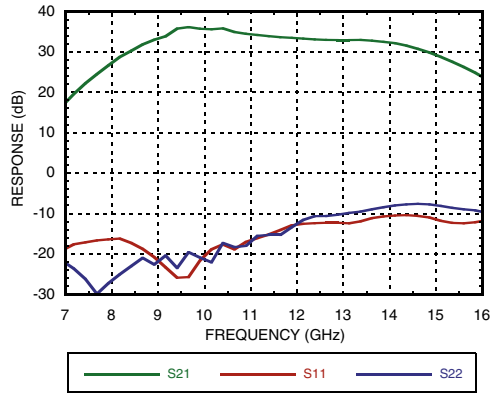

Gain vs. Temperature

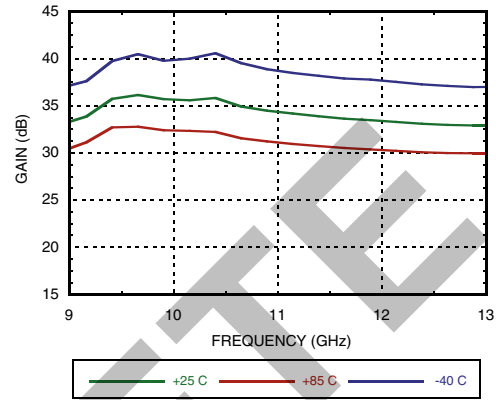

Input Return Loss vs. Temperature

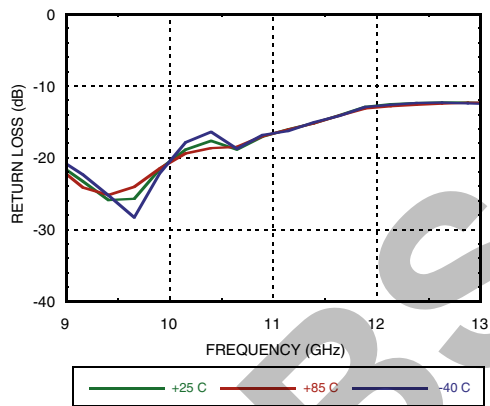

Output Return Loss vs. Temperature

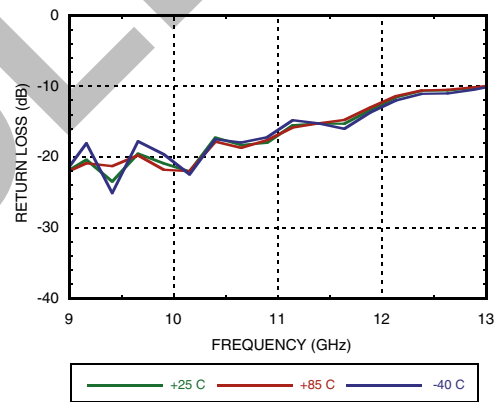

P1dB vs. Temperature

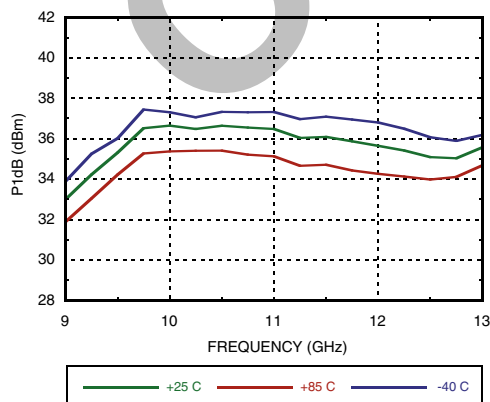

P1dB vs. Supply Voltage

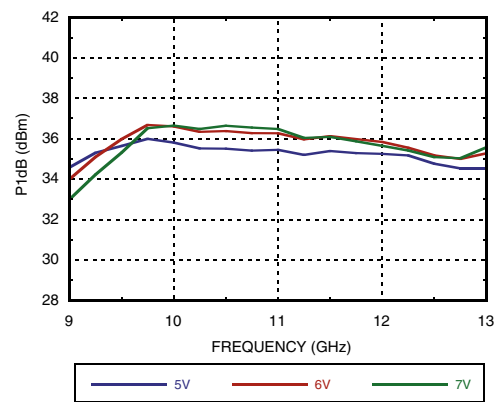

Information furnished by Analog Devices is believed to be accurate and reliable. However, no responsibility is assumed by Analog Devices for its use, nor for any infringements of patents or other rights of third parties that may result from its use. Specifications subject to change without notice. No license is granted by implication or otherwise under any patent or patent rights of Analog Devices. Trademarks and registered trademarks are the property of their respective owners.

For price, delivery, and to place orders: Analog Devices, Inc., One Technology Way, P.O. Box 9106, Norwood, MA 02062-9106 Phone: 781-329-4700 • Order online at www.analog.com Application Support: Phone: 1-800-ANALOG-D

GaAs pHEMT MMIC 4 WATT POWER AMPLIFIER WITH POWER DETECTOR, 9 - 12 GHz



Psat vs. Temperature

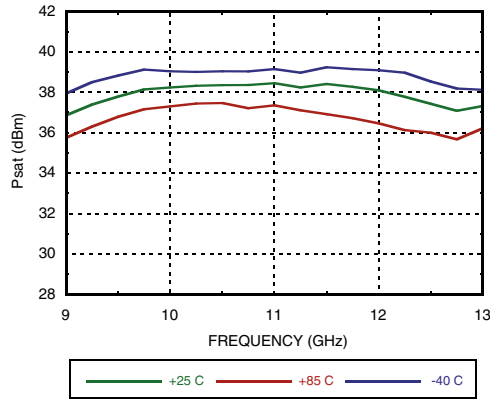

Psat vs. Supply Voltage

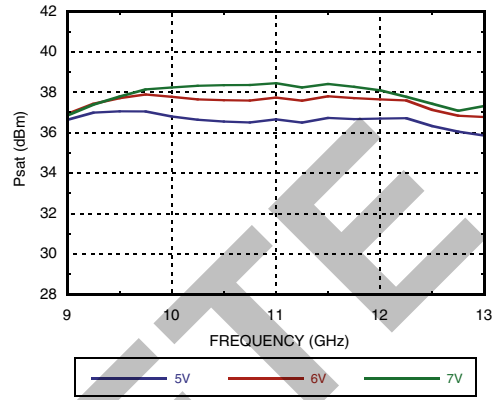

P1dB vs. Supply Current

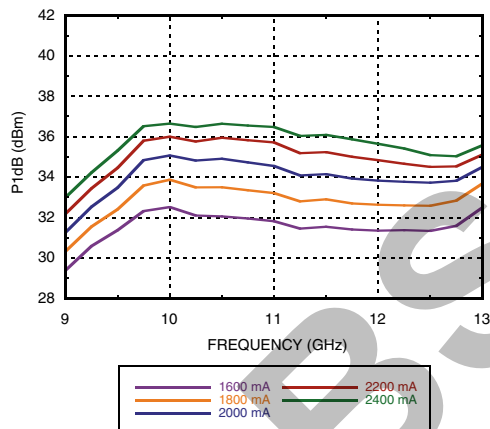

Psat vs. Supply Current

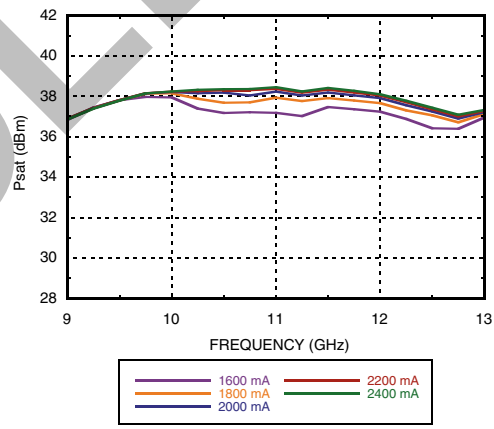

Output IP3 vs. Temperature, Pout/tone = +20 dBm

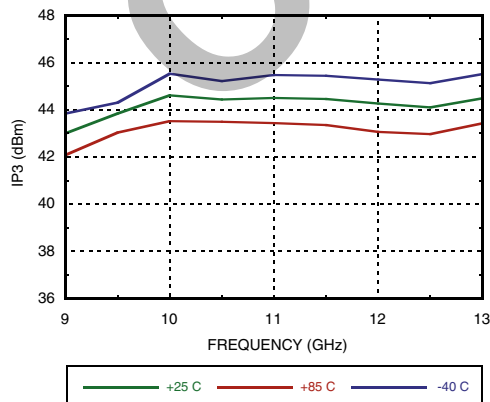

Output IP3 vs. Supply Current, Pout/tone = +20 dBm

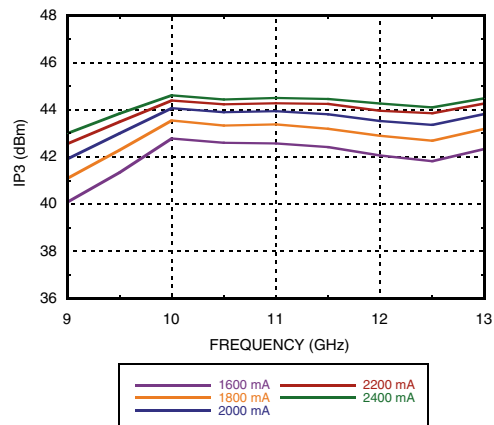

Information furnished by Analog Devices is believed to be accurate and reliable. However, no responsibility is assumed by Analog Devices for its use, nor for any infringements of patents or other rights of third parties that may result from its use. Specifications subject to change without notice. No license is granted by implication or otherwise under any patent or patent rights of Analog Devices. Trademarks and registered trademarks are the property of their respective owners.

For price, delivery, and to place orders: Analog Devices, Inc., One Technology Way, P.O. Box 9106, Norwood, MA 02062-9106 Phone: 781-329-4700 • Order online at www.analog.com Application Support: Phone: 1-800-ANALOG-D

GaAs pHEMT MMIC 4 WATT POWER AMPLIFIER WITH POWER DETECTOR, 9 - 12 GHz



Output IP3 vs. Supply Voltage, Pout/tone = +20 dBm

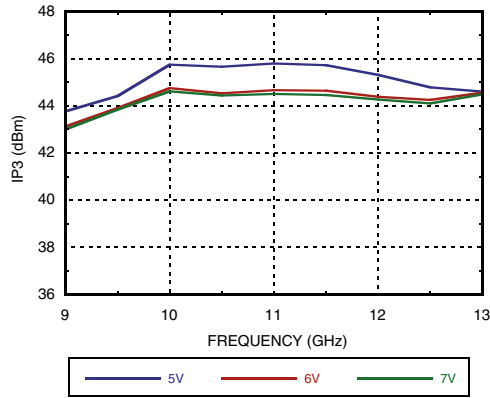

Output IM3 @ Vdd = +5V

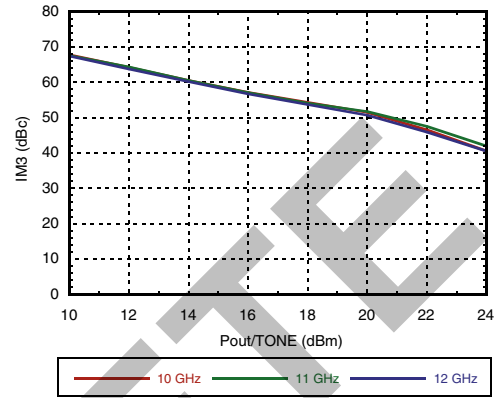

Output IM3 @ Vdd = +6V

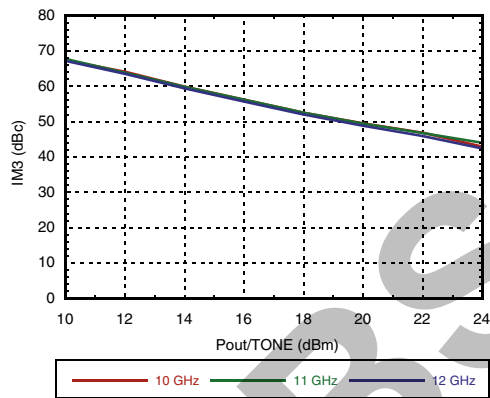

Output IM3 @ Vdd = +7V

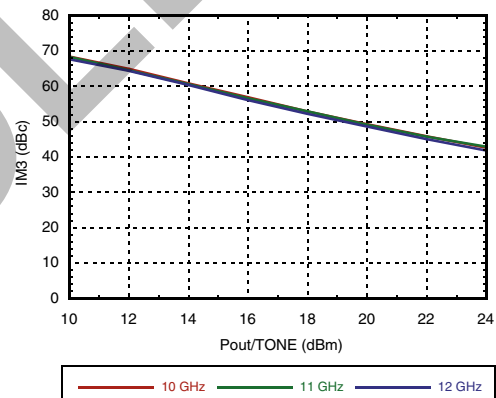

Power Compression @ 9.5 GHz

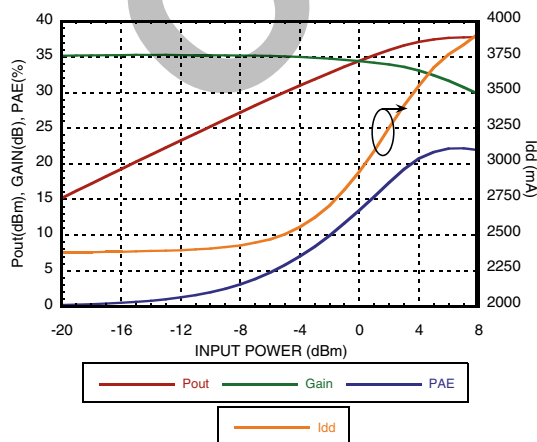

Power Compression @ 11 GHz

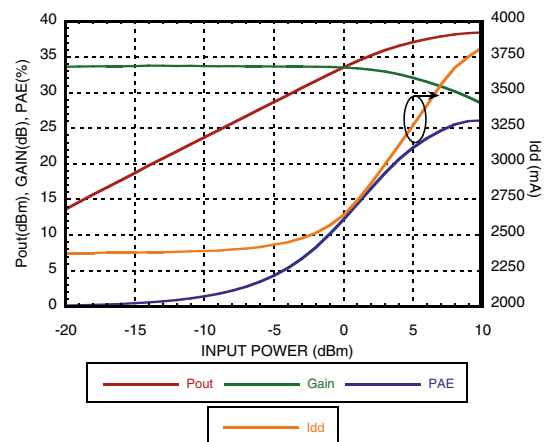

Information furnished by Analog Devices is believed to be accurate and reliable. However, no responsibility is assumed by Analog Devices for its use, nor for any infringements of patents or other rights of third parties that may result from its use. Specifications subject to change without notice. No license is granted by implication or otherwise under any patent or patent rights of Analog Devices. Trademarks and registered trademarks are the property of their respective owners.

For price, delivery, and to place orders: Analog Devices, Inc., One Technology Way, P.O. Box 9106, Norwood, MA 02062-9106 Phone: 781-329-4700 • Order online at www.analog.com Application Support: Phone: 1-800-ANALOG-D

GaAs pHEMT MMIC 4 WATT POWER AMPLIFIER WITH POWER DETECTOR, 9 - 12 GHz



Power Compression @ 12 GHz

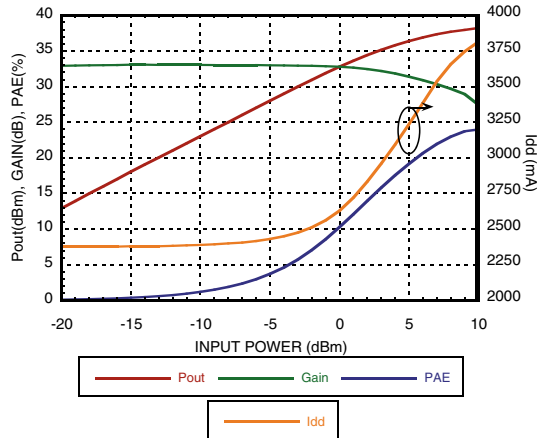

Detector Voltage vs. Temperature @ 9.5GHz

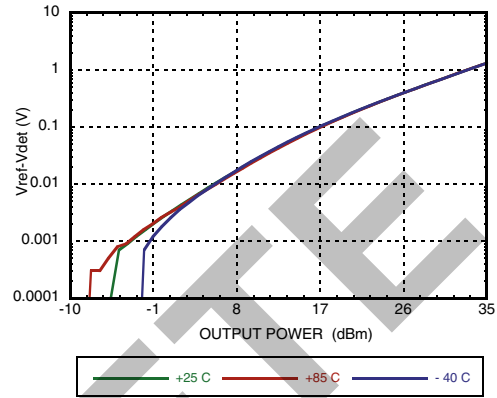

Reverse Isolation vs. Temperature

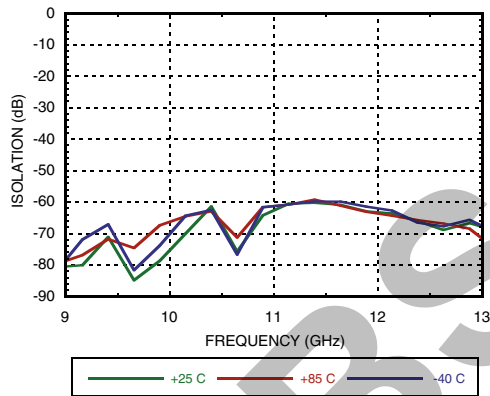

Gain & Power vs. Supply Current @ 11 GHz

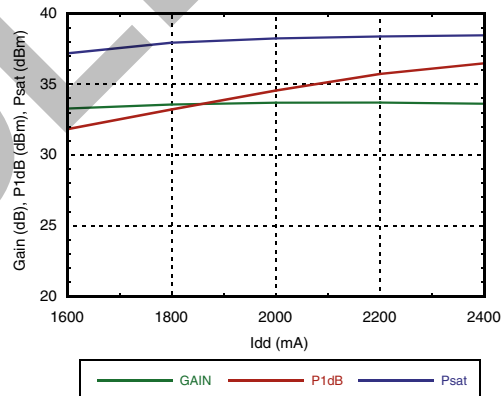

Gain & Power vs. Supply Voltage @ 11 GHz

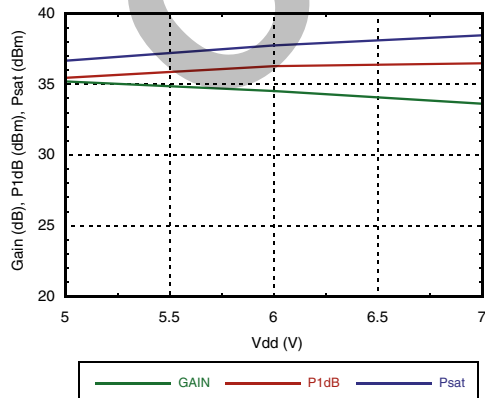

Power Dissipation

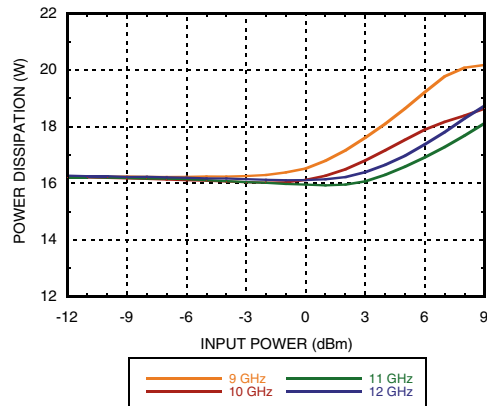

Information furnished by Analog Devices is believed to be accurate and reliable. However, no responsibility is assumed by Analog Devices for its use, nor for any infringements of patents or other rights of third parties that may result from its use. Specifications subject to change without notice. No license is granted by implication or otherwise under any patent or patent rights of Analog Devices. Trademarks and registered trademarks are the property of their respective owners.

For price, delivery, and to place orders: Analog Devices, Inc., One Technology Way, P.O. Box 9106, Norwood, MA 02062-9106 Phone: 781-329-4700 • Order online at www.analog.com Application Support: Phone: 1-800-ANALOG-D

GaAs pHEMT MMIC 4 WATT POWER AMPLIFIER WITH POWER DETECTOR, 9 - 12 GHz



Absolute Maximum Ratings

Drain Bias Voltage (Vdd)	+8 Vdc
Gate Bias Voltage (Vgg)	-3 - 0 Vdc
RF Input Power (RFIN)	+27 dBm
Channel Temperature	150 °C
Continuous Pdiss (T= 85 °C) (derate 294 mW/°C above 85 °C)	19.2 W
Thermal Resistance (channel to ground paddle)	3.39 °C/W
Storage Temperature	-65 to 150 °C
Operating Temperature	-40 to 85 °C
ESD Sensitivity (HBM)	Class 1A

Typical Supply Current vs. Vdd

Vdd (V)	Idd (mA)
+5	2400
+6	2400
+7	2400

Adjust Vgg1 to achieve Idd = 2400 mA



**ELECTROSTATIC SENSITIVE DEVICE
OBSERVE HANDLING PRECAUTIONS**

Outline Drawing

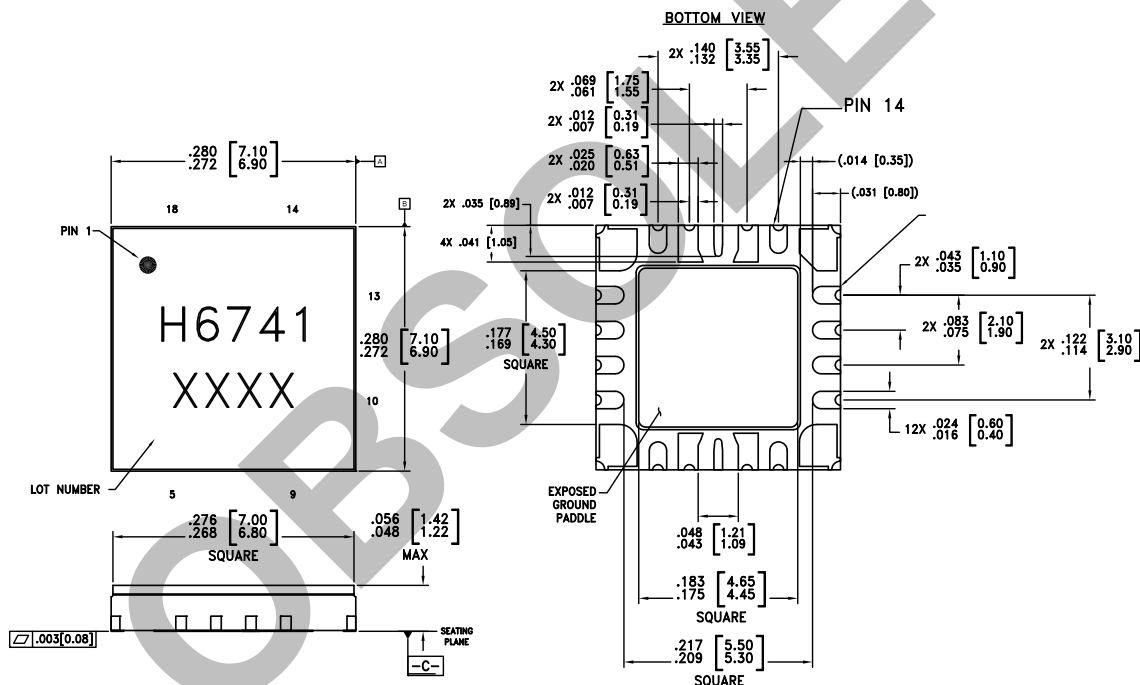

NOTES:

1. PACKAGE BODY MATERIAL: ALUMINA.
2. LEAD AND GROUND PADDLE PLATING: GOLD FLASH OVER NICKEL.
3. DIMENSIONS ARE IN INCHES (MILLIMETERS).
4. LEAD SPACING TOLERANCE IS NON-CUMULATIVE.
5. PACKAGE WARP SHALL NOT EXCEED 0.05 MM DATUM - C -
6. ALL GROUND LEADS AND GROUND PADDLE MUST BE SOLDERED TO PCB RF GROUND.

Package Information

Part Number	Package Body Material	Lead Finish	MSL Rating [2]	Package Marking [1]
HMC6741LS7	ALUMINA WHITE	Gold over Nickel	N/A	H6741 XXXX



[1] 4-Digit lot number XXXX

[2] Max peak reflow temperature of 260 °C

GaAs pHEMT MMIC 4 WATT POWER AMPLIFIER WITH POWER DETECTOR, 9 - 12 GHz

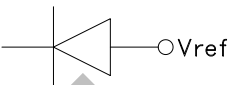

Pin Descriptions

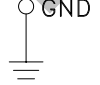
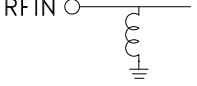
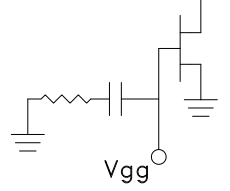
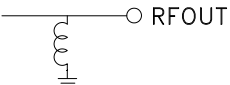
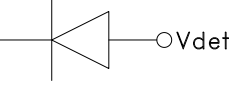
Pin Number	Function	Description	Interface Schematic
1	Vref	DC voltage of diode biased through external resistor used for temperature compensation of Vdet.	
2, 3, 4, 5, 10, 11, 12, 13	Vdd7, Vdd5, Vdd3, Vdd1, Vdd2, Vdd4, Vdd6, Vdd8	Drian bias voltage for the amplifier. External bypass capacitors of 100pF, 0.01uF and 4.7uF are required.	
6, 8, 15, 17	GND	These pins and package bottom must be connected to RF/DC ground.	
7	RFIN	This pin is DC coupled and matched to 50 Ohms.	
9	Vgg	Gate control for amplifier, Vdd1 - Vdd8. External bypass capacitors of 100pF, 0.01uF and 4.7uF are required.	
14	N/C	This pin is not connected internally, however all datashown herein was measured with this pin connected to RF/DC ground externally..	
16	RFOUT	This pin is DC coupled and matched to 50 Ohms.	
18	Vdet	DC voltage representing RF output power rectified by diode which is biased through an external resistor. See application circuit.	

**GaAs pHEMT MMIC 4 WATT POWER AMPLIFIER
WITH POWER DETECTOR, 9 - 12 GHz**



Application Circuit

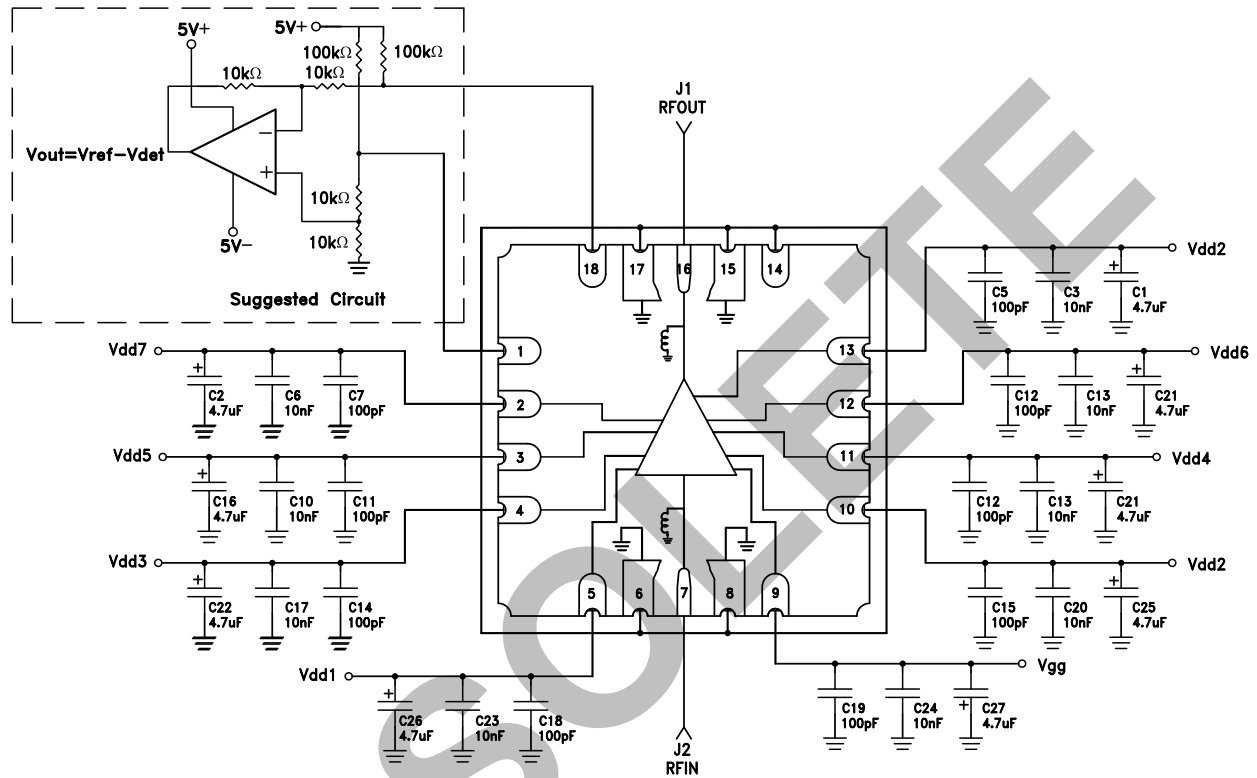

Information furnished by Analog Devices is believed to be accurate and reliable. However, no responsibility is assumed by Analog Devices for its use, nor for any infringements of patents or other rights of third parties that may result from its use. Specifications subject to change without notice. No license is granted by implication or otherwise under any patent or patent rights of Analog Devices. Trademarks and registered trademarks are the property of their respective owners.

For price, delivery, and to place orders: Analog Devices, Inc., One Technology Way, P.O. Box 9106, Norwood, MA 02062-9106 Phone: 781-329-4700 • Order online at www.analog.com Application Support: Phone: 1-800-ANALOG-D

**GaAs pHEMT MMIC 4 WATT POWER AMPLIFIER
WITH POWER DETECTOR, 9 - 12 GHz**



Evaluation PCB

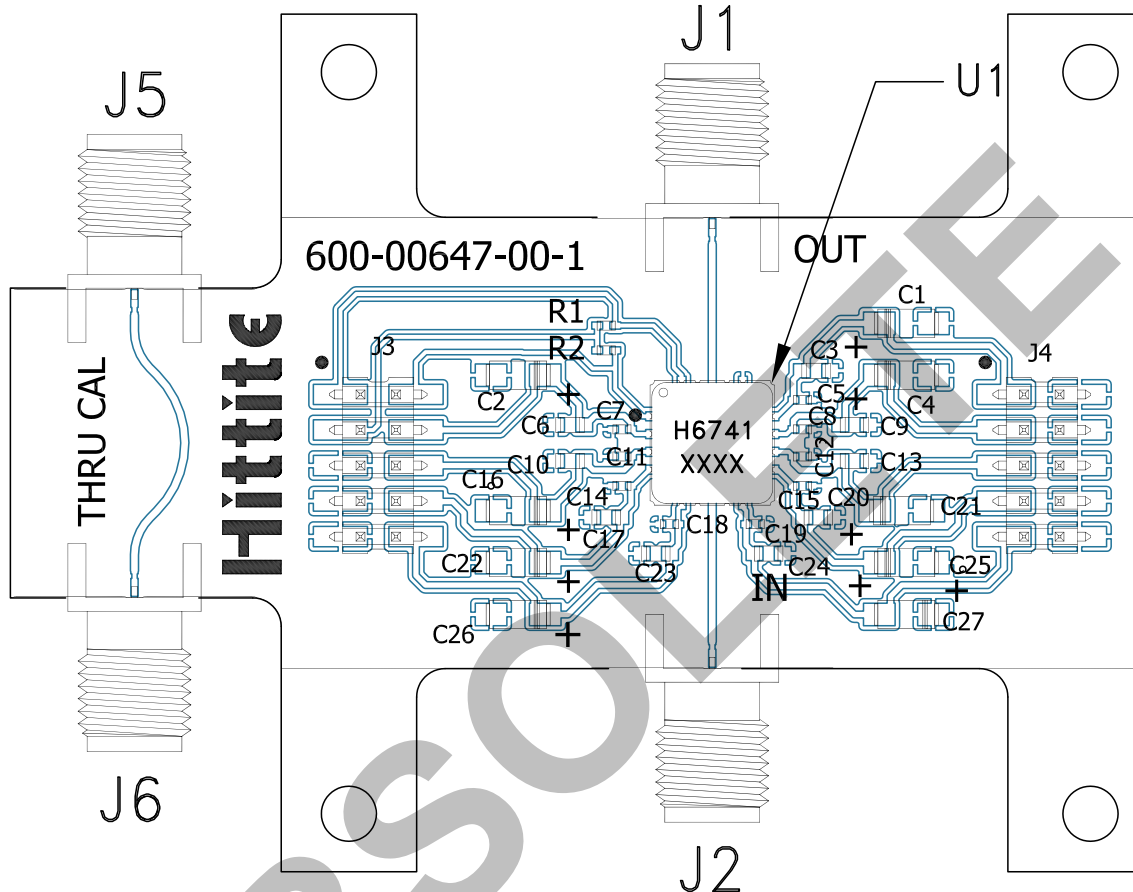

List of Materials for Evaluation PCB EVAL01-HMC6741LS7 [1]

Item	Description
J1, J2, J5, J6	K Connector SRI
J3, J4	DC Pin
R1, R2	40.2K Ohm
C5, C7, C8, C11, C12, C14, C15, C18, C19	100 pF Capacitor, 0402 Pkg.
C3, C6, C9, C10, C13, C17, C20, C23, C24	10 nF Capacitor, 0402 Pkg.
C1, C2, C4, C16, C21, C22, C25, C27	4.7uF Capacitor, Case A.
U1	HMC6741LS7 Power Amplifier
PCB	600-00647-00 Evaluation PCB

The circuit board used in the application should use RF circuit design techniques. Signal lines should have 50 Ohm impedance while the package ground leads and exposed paddle should be connected directly to the ground plane similar to that shown. A sufficient number of via holes should be used to connect the top and bottom ground planes. The evaluation circuit board shown is available from Hittite upon request.

[1] Reference this number when ordering complete evaluation PCB

[2] Circuit Board Material: Rogers 4350 or Arlon FR4

v01.0414

**GaAs pHEMT MMIC 4 WATT POWER AMPLIFIER
WITH POWER DETECTOR, 9 - 12 GHz****Notes:**

OBSOLETE