



Chipsmall Limited consists of a professional team with an average of over 10 year of expertise in the distribution of electronic components. Based in Hongkong, we have already established firm and mutual-benefit business relationships with customers from,Europe,America and south Asia,supplying obsolete and hard-to-find components to meet their specific needs.

With the principle of “Quality Parts,Customers Priority,Honest Operation,and Considerate Service”,our business mainly focus on the distribution of electronic components. Line cards we deal with include Microchip,ALPS,ROHM,Xilinx,Pulse,ON,Everlight and Freescale. Main products comprise IC,Modules,Potentiometer,IC Socket,Relay,Connector.Our parts cover such applications as commercial,industrial, and automotives areas.

We are looking forward to setting up business relationship with you and hope to provide you with the best service and solution. Let us make a better world for our industry!



## Contact us

Tel: +86-755-8981 8866 Fax: +86-755-8427 6832

Email & Skype: info@chipsmall.com Web: www.chipsmall.com

Address: A1208, Overseas Decoration Building, #122 Zhenhua RD., Futian, Shenzhen, China



# AN-EVAL-3AR4780VJZ

## 12W 5V SMPS evaluation board with ICE3AR4780VJZ

Application Note

### About this document

#### Scope and purpose

This document is a 12W 5.0V, universal input off-line flyback converter evaluation board using Infineon CoolSET™ F3R80 family, ICE3AR4780VJZ.

#### Intended audience

This document is intended for users of the ICE3AR4780VJZ who wish to design low cost and high reliable system of off-line SMPS for enclosed adapter or open frame auxiliary power supply of white goods, PC, server, DVD, TV, Set-top box, etc.

### Table of Contents

<b>About this document .....</b>	<b>1</b>
<b>Table of Contents.....</b>	<b>1</b>
<b>1 Abstract .....</b>	<b>3</b>
<b>2 Evaluation board .....</b>	<b>3</b>
<b>3 Evaluation board specifications.....</b>	<b>4</b>
<b>4 List of features (ICE3AR4780VJZ) .....</b>	<b>4</b>
<b>5 Circuit description.....</b>	<b>5</b>
5.1 Introduction.....	5
5.2 Line input .....	5
5.3 Line input over voltage protection.....	5
5.4 Start up.....	5
5.5 Operation mode .....	5
5.6 Soft start.....	5
5.7 RCD clamper circuit.....	5
5.8 Peak current control of primary current.....	6
5.9 Output stage .....	6

**Abstract**

<b>6</b>	<b>Circuit diagram .....</b>	<b>7</b>
<b>7</b>	<b>PCB layout .....</b>	<b>8</b>
7.1	Top side .....	8
7.2	Bottom side.....	8
<b>8</b>	<b>Component list .....</b>	<b>9</b>
<b>9</b>	<b>Transformer construction .....</b>	<b>10</b>
<b>10</b>	<b>Test results .....</b>	<b>11</b>
10.1	Efficiency .....	11
10.2	Standby power .....	12
10.3	Line regulation.....	13
10.4	Load regulation .....	13
10.5	Maximum power.....	14
10.6	ESD immunity (EN61000-4-2).....	14
10.7	Surge immunity (EN61000-4-5).....	14
10.8	Conducted emissions (EN55022 class B) .....	15
10.9	Thermal measurement .....	17
<b>11</b>	<b>Waveforms and scope plots.....</b>	<b>18</b>
11.1	Start up at low/high AC line input voltage with maximum load .....	18
11.2	Soft start.....	18
11.3	Frequency jittering.....	19
11.4	Drain voltage and current at maximum load .....	19
11.5	Load transient response (Dynamic load from 10% to 100%) .....	20
11.6	Output ripple voltage at maximum load .....	20
11.7	Output ripple voltage during burst mode at 1 W load .....	21
11.8	Active Burst mode operation .....	21
11.9	V <sub>cc</sub> over voltage protection (Odd skip auto restart mode) .....	22
11.10	Over load protection (Auto restart mode) .....	22
11.11	V <sub>cc</sub> under voltage/Short optocoupler protection (Normal auto restart mode).....	23
11.12	AC Line input OVP mode.....	23
<b>12</b>	<b>References .....</b>	<b>24</b>
<b>Revision History.....</b>		<b>24</b>



## Abstract

### 1 Abstract

This document is an engineering report of a universal input 12W 5V off-line flyback converter power supply utilizing F3R80 CoolSET™ ICE3AR4780VJZ. The application evaluation board is operated in Discontinuous Conduction Mode (DCM) and is running at 100 kHz switching frequency. It has a single output voltage with secondary side control regulation. It is especially suitable for small power supply such as DVD player, set-top box, game console, charger and auxiliary power of white goods, server, PC and high power system, etc. The ICE3AR4780VJZ is the latest version of the CoolSET™. Besides having the basic features of the F3R CoolSET™ such as Active Burst Mode, propagation delay compensation, soft gate drive, auto restart protection for major fault (Vcc over voltage, Vcc under voltage, adjustable input OVP, over temperature, over-load, open loop and short opto-coupler), it also has the BiCMOS technology design, selectable entry and exit burst mode level, adjustable AC line input over voltage protection feature, built-in soft start time, built-in and extendable blanking time and frequency jitter feature, etc. The particular features are the best-in-class low standby power and the good EMI performance.

### 2 Evaluation board

This document contains the list of features, the power supply specification, schematic, bill of material and the transformer construction documentation. Typical operating characteristics such as performance curve and scope waveforms are showed at the rear of the report.

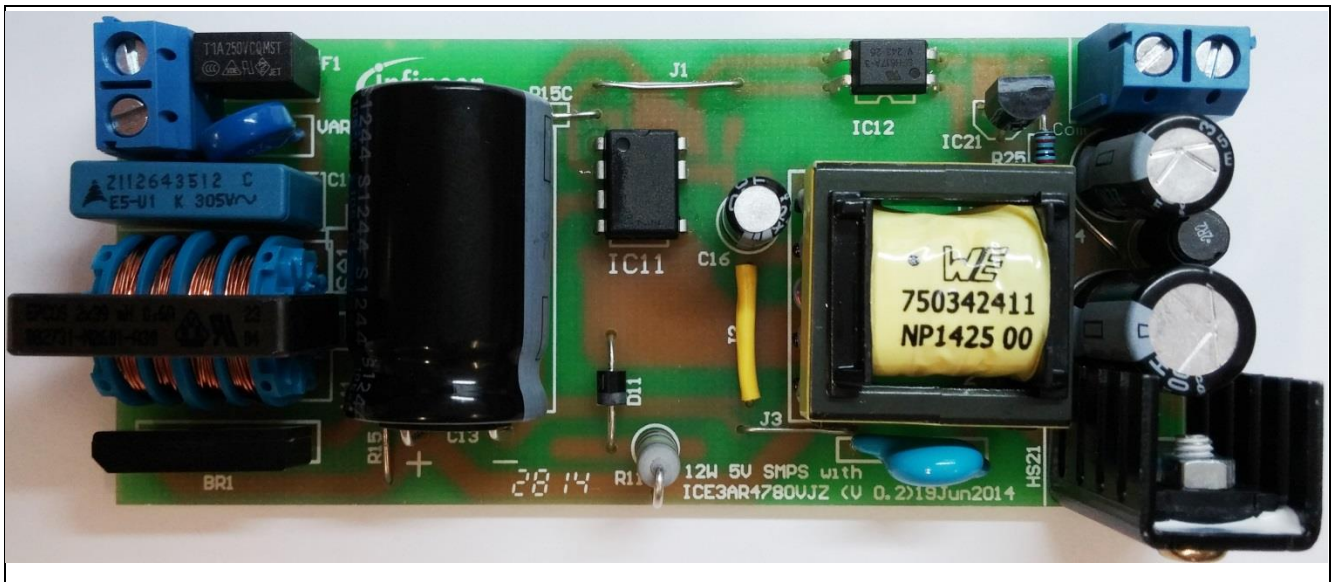

Figure 1 EVAL-3AR4780VJZ [Dimensions L x W x H: 95mm x 41mm x 24mm (3.74" x 1.61" x 0.94")]

---

**Evaluation board specifications**

### 3 Evaluation board specifications

Input voltage	85VAC~265VAC
Input frequency	50~60Hz
Output voltage	5V
Output current	2.4A
Output power	12W
Steady state output ripple voltage (±1% of nominal output voltage)	$V_{\text{ripple\_P\_P}} < 50\text{mV}$
Dynamic load response undershoot & overshoot (±3% of nominal output voltage)	$V_{\text{ripple\_P\_P}} < 250\text{mV}$
Active mode four point average efficiency (25%,50%,75% & 100%load) (EU CoC Version 5, Tier 1)	>80% at 115Vac and >79% at 230Vac
Active mode at 10% load efficiency (EU CoC Version 5, Tier 1)	>73%
No-load power consumption (EU CoC Version 5, Tier 2)	< 75mW
Maximum input power(Peak Power) for universal input range (<±5% of average maximum input power)	<±3% of average maximum input power
Form factor case size (L x W x H)	95mm x 41mm x 24mm (3.74" x 1.61" x 0.94")

### 4 List of features (ICE3AR4780VJZ)

---

800V avalanche rugged CoolSET™ with Startup Cell
Active Burst Mode for lowest Standby Power
Selectable entry and exit burst mode level
100kHz internally fixed switching frequency with jittering feature
Auto Restart Protection for Over load, Open Loop, VCC Under voltage & Over voltage and Over temperature
Over temperature protection with 50°C hysteresis
Built-in 10ms Soft Start
Built-in 20ms and extendable blanking time for short duration peak power
Propagation delay compensation for both maximum load and burst mode
Adjustable input OVP
Overall tolerance of Current Limiting < ±5%
BiCMOS technology for low power consumption and wide VCC voltage range
Soft gate drive with 50Ω turn on resistor

---

---

## Circuit description

# 5 Circuit description

## 5.1 Introduction

The EVAL-3AR4780VJZ evaluation board is a low cost off-line flyback switch mode power supply (SMPS) using the ICE3AR4780VJZ integrated power IC from the CoolSET™-F3R80 family. The circuit shown in Figure 3, details a 5V, 12W power supply that operates from an AC line input voltage range of 85Vac to 265Vac and line input OVP detect/reset voltage is 300/282Vac, suitable for applications in enclosed adapter or open frame auxiliary power supply for different system such as white goods, PC, server, DVD, LED TV, Set-top box, etc.

## 5.2 Line input

The AC line input side comprises the input fuse F1 as over-current protection. The choke L11, X-capacitors C11, C14 and Y-capacitor C12 act as EMI suppressors. Optional spark gap device SG1, SG2 and varistor VAR can absorb high voltage stress during lightning surge test. After the bridge rectifier BR1 and the input bulk capacitor C13, a voltage of 90 to 424 V<sub>DC</sub> is present which depends on input line voltage.

## 5.3 Line input over voltage protection

The AC line input OVP mode is detected by sensing the voltage level at BV pin through the resistors divider from the bulk capacitor. Once the voltage level at BV pin hits above 1.98V, the controller stops switching and enters into input OVP mode. When the BV voltage drops to 1.91V and the V<sub>CC</sub> hits 17V, the input OVP mode is released.

## 5.4 Start up

Since there is a built-in startup cell in the ICE3AR4780VJZ, no external start up resistor is required. The startup cell is connecting the drain pin of the IC. Once the voltage is built up at the Drain pin of the ICE3AR4780VJZ, the startup cell will charge up the V<sub>CC</sub> capacitor C16 and C17. When the V<sub>CC</sub> voltage exceeds the UVLO at 17V, the IC starts up. Then the V<sub>CC</sub> voltage is bootstrapped by the auxiliary winding to sustain the operation.

## 5.5 Operation mode

During operation, the V<sub>CC</sub> pin is supplied via a separate transformer winding with associated rectification D12 and buffering C16, C17. In order not to exceed the maximum voltage at V<sub>CC</sub> pin due to poor coupling of transformer winding, an external zener diode ZD11 and resistor R13 can be added.

## 5.6 Soft start

The Soft-Start is a built-in function and is set at 10ms.

## 5.7 RCD clamper circuit

While turns off the CoolMOS™, the clamper circuit R11, C15 and D11 absorbs the current caused by transformer leakage inductance once the voltage exceeds clamp capacitor voltage. Finally drain to source voltage of CoolMOS™ is lower than maximum break down voltage ( $V_{(BR)DSS} = 800V$ ) of CoolMOS™.

---

### Circuit description

#### 5.8 Peak current control of primary current

The CoolMOS™ drain source current is sensed via external shunt resistors R14 and R14A which determine the tolerance of the current limit control. Since ICE3AR4780VJZ is a current mode controller, it would have a cycle-by-cycle primary current and feedback voltage control which can make sure the maximum power of the converter is controlled in every switching cycle. Besides, the patented propagation delay compensation is implemented to ensure the maximum input power can be controlled in an even tighter manner. The evaluation board shows approximately  $\pm 2.2\%$  of average maximum input power (refer to Figure 11).

#### 5.9 Output stage

On the secondary side the power is coupled out by a schottky diode D21. The capacitor C22 & C23 provides energy buffering following with the LC filter L21 and C24 to reduce the output voltage ripple considerably. Storage capacitors C22 & C23 are selected to have a very small internal resistance (ESR) to minimize the output voltage ripple.

Circuit diagram

# 6 Circuit diagram

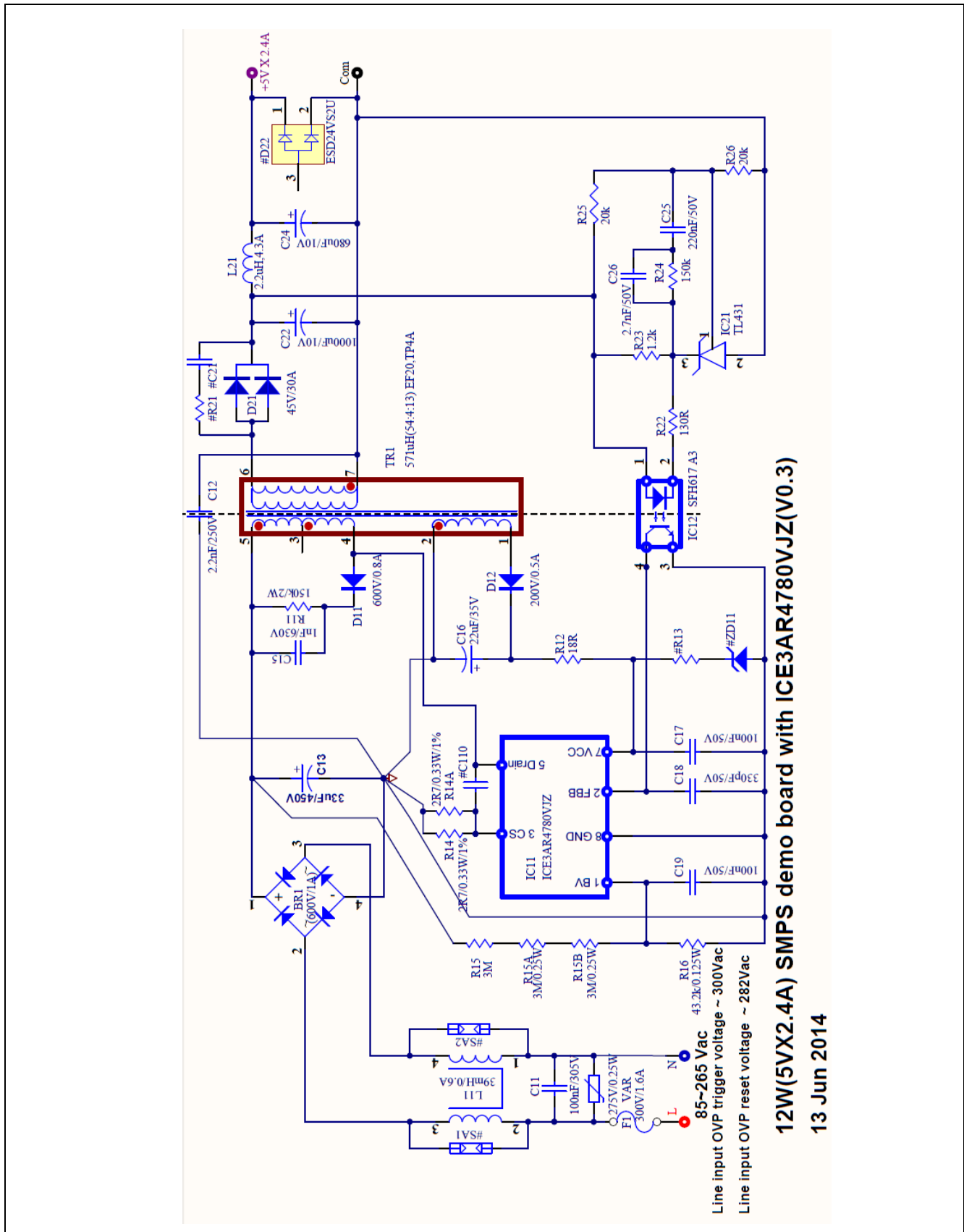

Figure 2 Schematic of EVAL-3AR4780VJZ





## Component list

## 8 Component list

No.	Designator	Component Description	Footprint	Part Number	Manufacturer	Quantity
1	+5V Com, L N	12V Test Point	Connector	691102710002	Wurth Electronics	2
2	BR1	600V/1A	1V	S1VBA60	SHINDENGEN	1
3	C11	100nF/305V	MKT5/18/15	B329221C3104K	EPCOS	1
4	C12	2.2nF/250V	MKT2/13/10	DE1E3KX222MA4BN01F	MURATA	1
5	C13	33uF/450V	RB16X25	450BXC33MEFC16X25	RUBYCON	1
6	C15	1nF/630V	1206	GRM31A7U2J102JW31D	MURATA	1
7	C16	22uF/50V	RB5.5	50PX22MEFC5X11	RUBYCON	1
8	C17,C19	100nF/50V	0603	GRM188R71H104KA93D	MURATA	2
9	C18	330pF/50V	0603	GRM1885C1H331GA01D	MURATA	1
10	C22	1000uF/10V	RB10	10ZLH1000MEFC10X12.5	RUBYCON	1
11	C24	680uF/10V	RB8	10ZLH680MEFC8X11.5	RUBYCON	1
12	C25	220nF/50V	0603	GRM188R71H224KAC4D	MURATA	1
13	C26	2.7nF/50V	0603	GRM188R71H272KA01D	MURATA	1
14	D11	600V/0.8A	DIODE0.4	D1NK60	SHINDENGEN	1
15	D12	200V/0.5A	1206D	GL34D		1
16	D21	45V/30A	TO-220FPAB	STPS30L45CFP		1
17	F1	300V/1.6A	MKT4.3/8.4/5	36911600000		1
18	HS1	TO220 heat sink	HS TO220	577202B00000G		1
19	IC11	ICE3AR4780VJZ	DIP7	ICE3AR4780VJZ	INFINEON	1
20	IC12	SFH617 A3	DIP4			1
21	IC21	TL431	TO92-TL431-			1
22	J1,J2,J3,J4,R15C	Jumper	Axial 0.4			5
23	L11	39mH/0.6A	EMI C U21	B82731M2601A030	EPCOS	1
24	L21	2.2uH/4.3A	CH6 2.5	7447462022	Wurth Electronics	1
25	R11	150k/2W	AXIAL0.4_V 4mm			1
26	R12	18R	0603			1
27	R14,R14A	2R7/0.33W/1%	1206	ERJ8BQF2R7V		2
28	R15	3M/1%	AXIAL0.4_15			1
29	R15A,R15B	3M/1%	1206			2
30	R16	43.2k/1%	0603			1
31	R22	130R	0603			1
32	R23	1.2k	0603			1
33	R24	150k	0603			1
34	R25	20k	AXIAL0.3			1
35	R26	20k	0603			1
36	TR1	571uH(54:4:13)	TR_EF20_H	750342411	Wurth Electronics Midcom	1
37	VAR	275V/0.25W	MKT3.5/7.5/5	B72207S2271K101	EPCOS	1

Transformer construction

## 9 Transformer construction

Core and material: EE20/10/6(EF20), TP4A (TDG)

Bobbin: 070-4989(10-Pins, TH-H, Horizontal version)

Primary Inductance,  $L_p=571\mu\text{H}$  ( $\pm 10\%$ ), measured between pin 4 and pin 5

Manufacturer and part number: Würth Electronics Midcom (750342411)

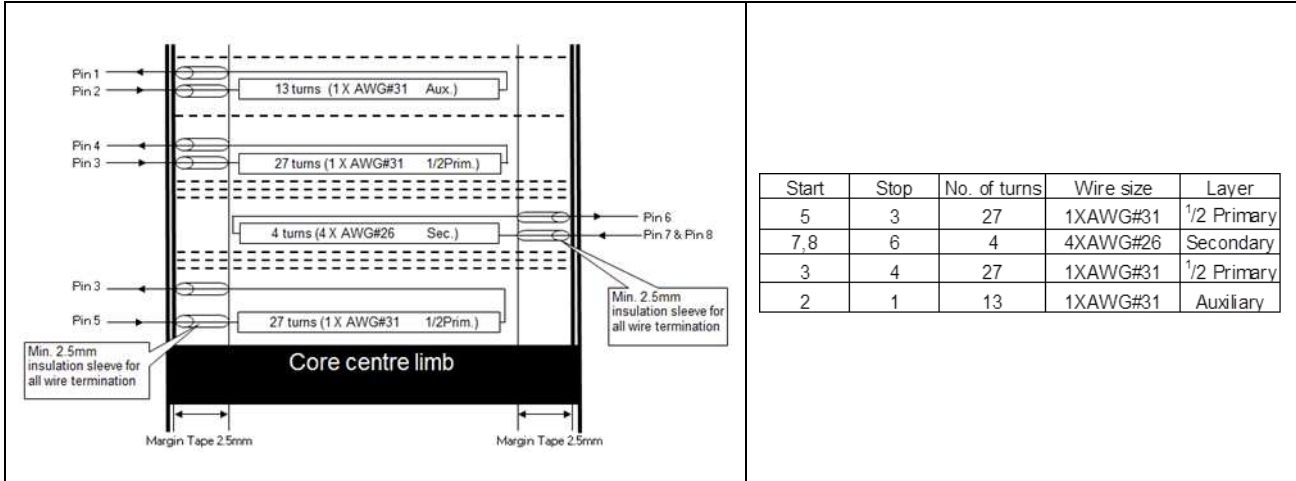

Start	Stop	No. of turns	Wire size	Layer
5	3	27	1XAWG#31	1/2 Primary
7, 8	6	4	4XAWG#26	Secondary
3	4	27	1XAWG#31	1/2 Primary
2	1	13	1XAWG#31	Auxiliary

CUSTOMER TERMINAL    RoHS    LEAD(Pb)-FREE

Sn96%, Ag4%    Yes    Yes

**PART MUST INSERT FULLY TO SURFACE & IN RECOMMENDED GRID**

TERM. NO.'s FOR REF. ONLY    LOT CODE & DATE CODE

RECOMMENDED P.C. PATTERN, COMPONENT SIDE

Wire insulation & RoHS status not affected by wire color.  
Wire insulation color may vary depending on availability.

more than you expect

**Midcom**  
WÜRTH ELEKTRONIK

**ELECTRICAL SPECIFICATIONS @ 25°C unless otherwise noted.**

PARAMETER	TEST CONDITIONS	VALUE
D.C. RESISTANCE	1-2 @20°C	0.271 ohms max.
D.C. RESISTANCE	4-5 @20°C	0.911 ohms max.
D.C. RESISTANCE	6-7 @20°C, tie(7+8)	0.010 ohms max.
INDUCTANCE	5-4 50kHz, 100mVAC, I <sub>s</sub>	571uH ±10%
LEAKAGE INDUCTANCE	5-4 tie(1+2+6+7+8), 100kHz, 100mVAC, I <sub>s</sub>	8.0 uH max.
DIELECTRIC	5-6 tie(2+3,7+8), 3750VAC, 1 second	-
DIELECTRIC	6-core tie(7+8), 3750VAC, 1 second	-
DIELECTRIC	5-core tie(2+3), 1875VAC, 1 second	-
TURNS RATIO	(5-4):(2-1)	4.15:1, ±2%
TURNS RATIO	(5-4):(7-8), tie(7+8)	13.5:1, ±2%

**GENERAL SPECIFICATIONS:**  
OPERATING TEMPERATURE RANGE: -40°C to +125°C including temp rise.  
Designed to comply with the following requirements as defined by IEC60950-1.  
- Reinforced insulation for a primary circuit at a working voltage of 420VDC.

REV.	DATE	Packaging Specifications
00	5/14	SEE REVISION SHEET FOR REVISION LEVEL

Tolerances unless otherwise specified:	
Angles: $\pm 1^\circ$	Decimals: $\pm 0.005$ [0.13]
Fractions: $\pm 1/64$	Footprint: $\pm 0.01$ [0.3]

DRAWING TITLE	PART NO.
TRANSFORMER	750342411

eCos p/n: 750342411

SPECIFICATION SHEET 1 OF 1

Figure 5 Transformer structure

Test results

## 10 Test results

Vin(Vac)	Pin(W)	Vo(Vdc)	Io(A)	V <sub>Out_ripple_pk_pk</sub> (mV)	Po(W)	η (%)	Average η (%)	OLP P <sub>in</sub> (W)	OLP I <sub>out</sub> (A)
85	0.0288	5.23	0.00	14.10			79.82	17.85	2.72
	1.6200	5.21	0.24	25.70	1.25	77.19			
	3.8500	5.19	0.600	10.70	3.11	80.88			
	7.6200	5.15	1.200	13.80	6.18	81.10			
	11.5600	5.11	1.800	15.50	9.20	79.57			
	15.6200	5.06	2.400	18.40	12.14	77.75			
115	0.0306	5.23	0.00	14.40			80.87	17.54	2.75
	1.6300	5.21	0.24	26.50	1.25	76.71			
	3.8300	5.19	0.600	10.70	3.11	81.31			
	7.5700	5.15	1.200	13.40	6.18	81.64			
	11.3700	5.11	1.800	15.60	9.20	80.90			
	15.2500	5.06	2.400	17.10	12.14	79.63			
230	0.0425	5.23	0.00	15.40			79.95	17.92	2.85
	1.6800	5.21	0.24	24.40	1.25	74.43			
	4.0000	5.19	0.600	10.60	3.11	77.85			
	7.6800	5.15	1.200	13.70	6.18	80.47			
	11.3700	5.11	1.800	16.10	9.20	80.90			
	15.0700	5.06	2.400	17.20	12.14	80.58			
265	0.0494	5.23	0.00	15.10			79.15	18.33	2.89
	1.7100	5.21	0.24	24.90	1.25	73.12			
	4.1000	5.19	0.600	10.00	3.11	75.95			
	7.7500	5.15	1.200	13.20	6.18	79.74			
	11.4300	5.11	1.800	16.00	9.20	80.47			
	15.1000	5.06	2.400	17.30	12.14	80.42			

### 10.1 Efficiency

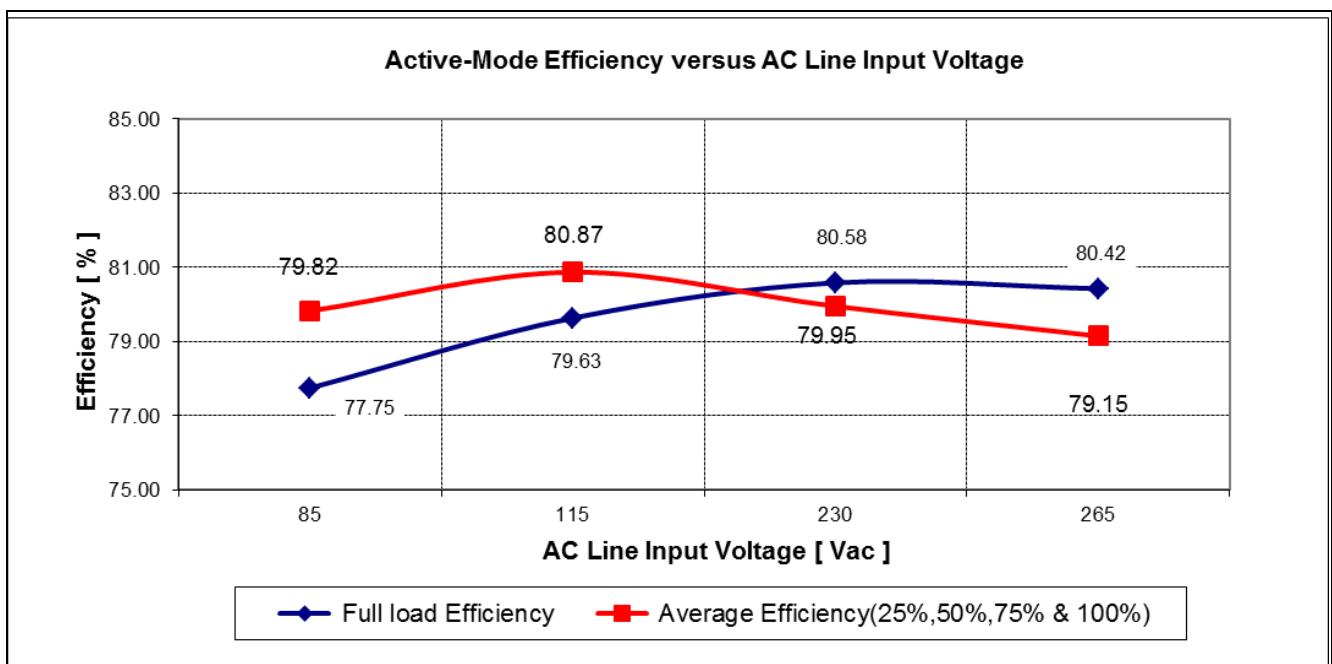

Figure 6 Efficiency vs AC line input voltage

Test results

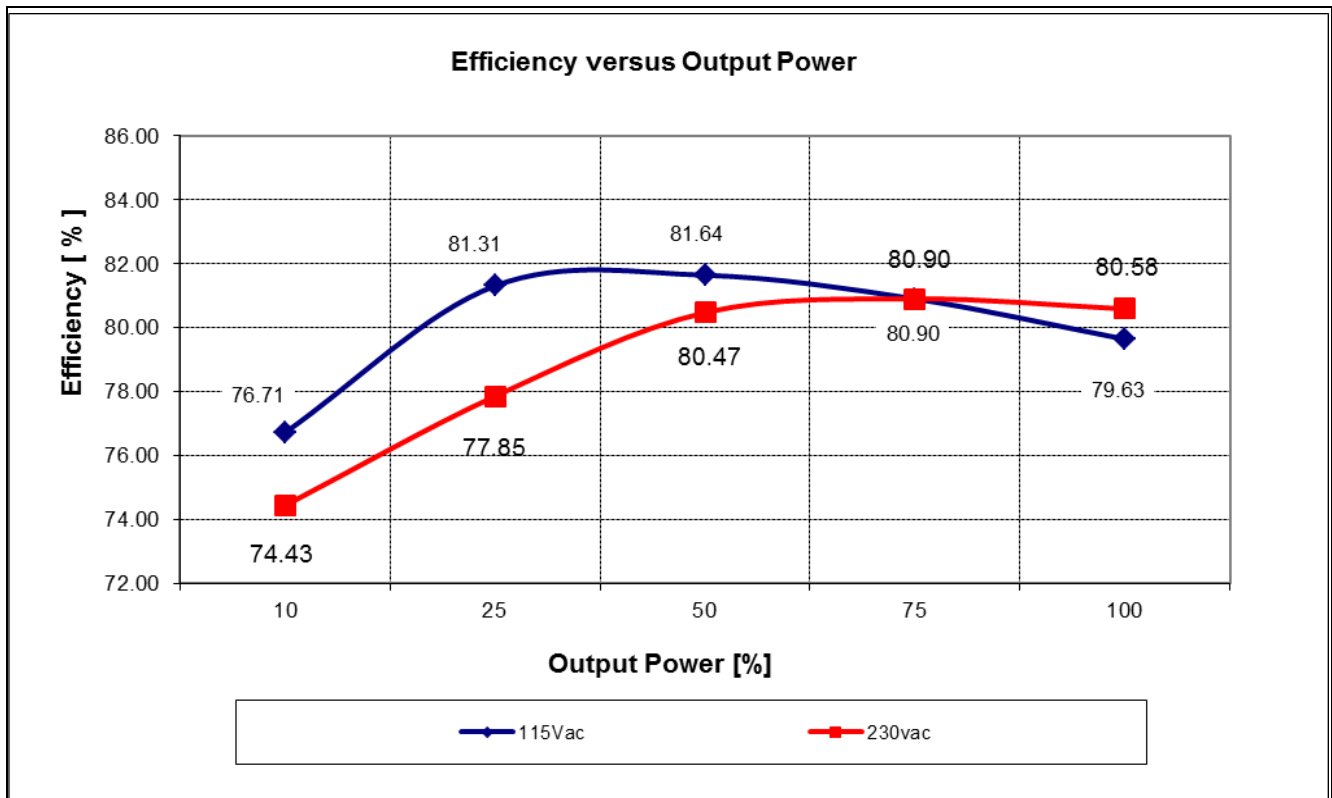

Figure 7 Efficiency vs output power @ 115Vac and 230V line

10.2 Standby power

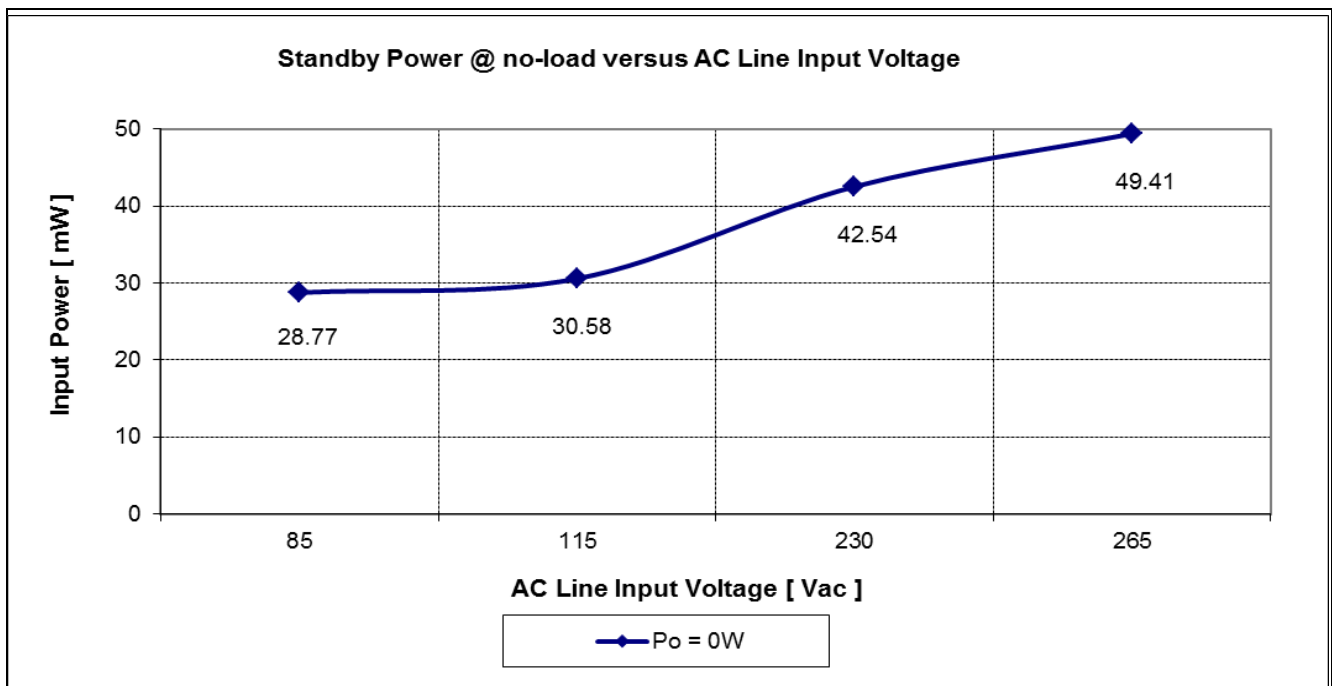

Figure 8 Standby power @ no load vs AC line input voltage (measured by Yokogawa WT210 power meter - integration mode)



Test results

10.3 Line regulation

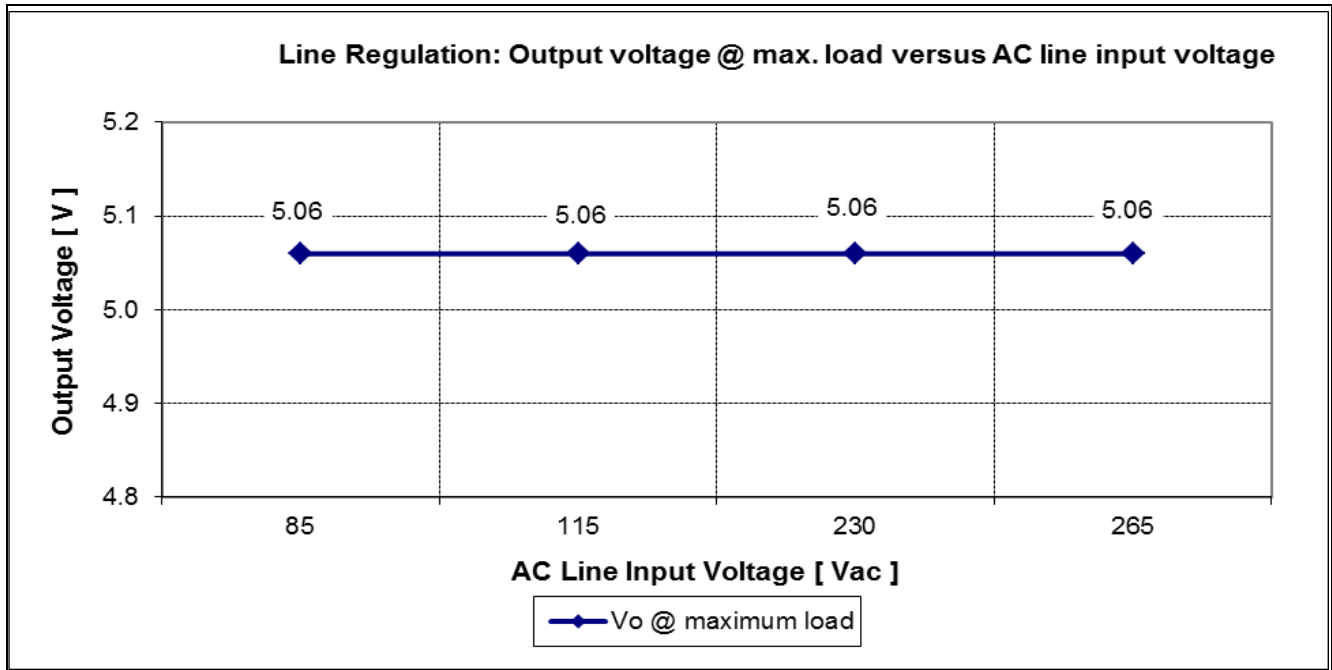

Figure 9 Line regulation Vo @ full load vs AC line input voltage

10.4 Load regulation

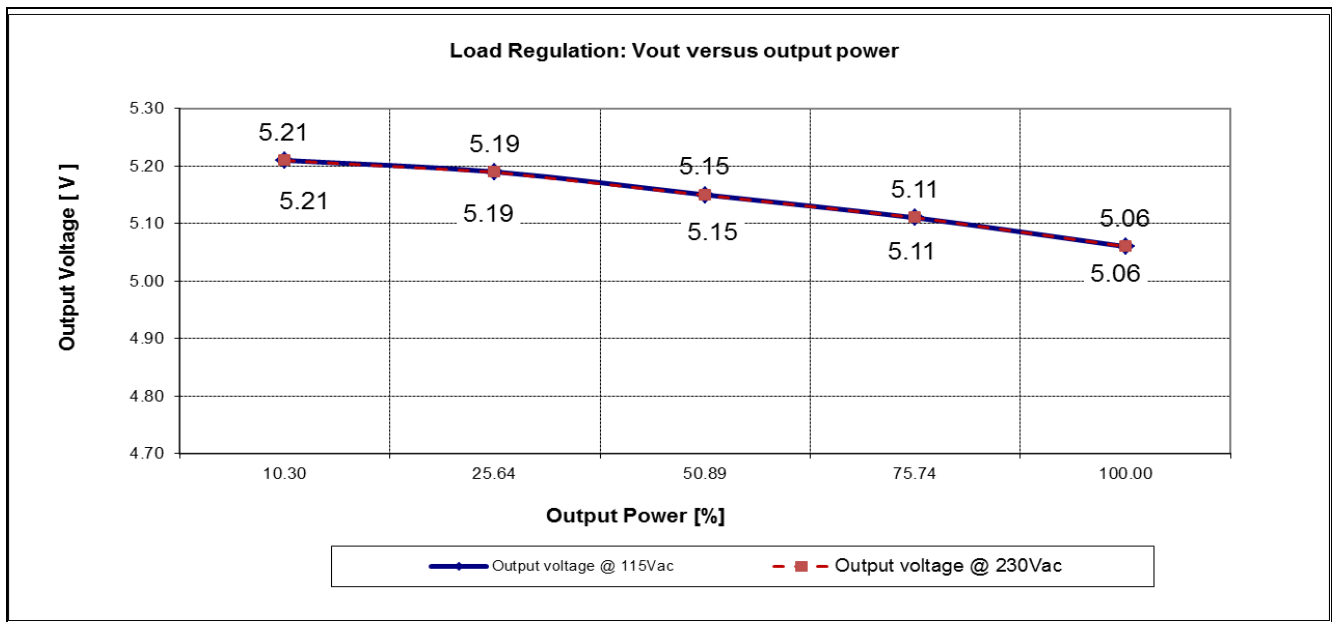

Figure 10 Load regulation Vo vs output power

Test results

10.5 Maximum power

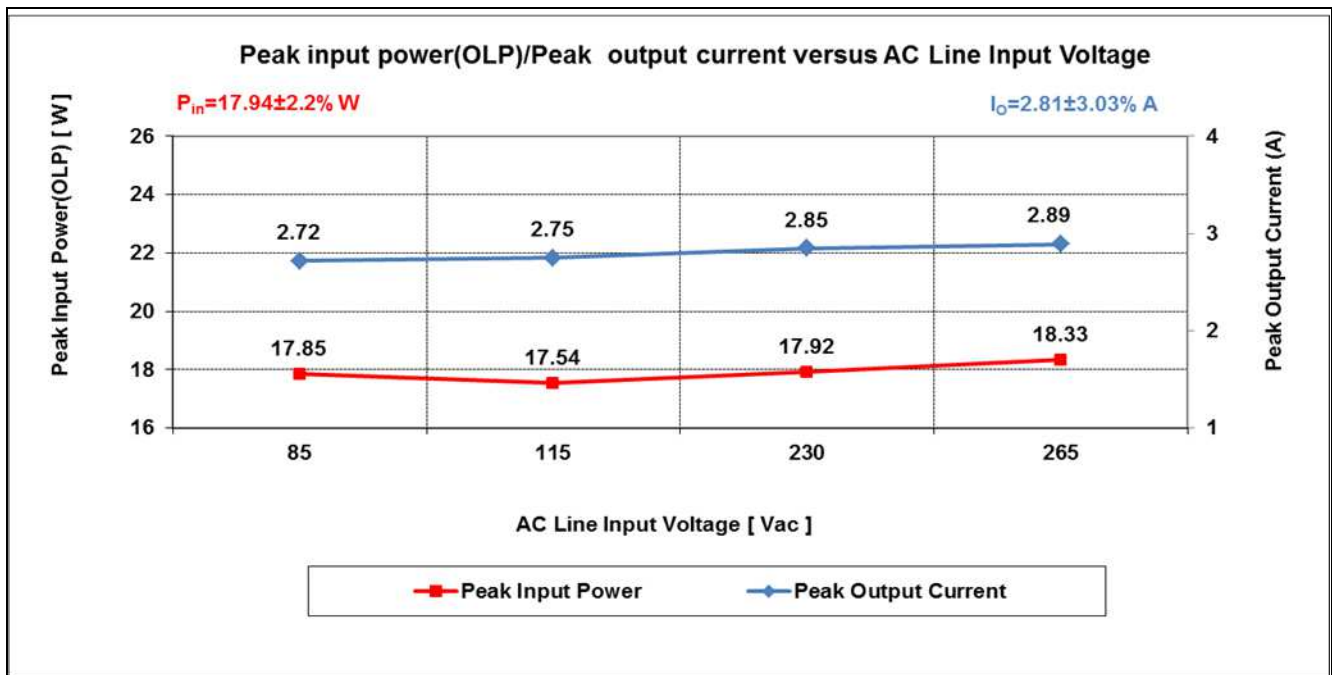

Figure 11 Maximum input power (before over-load protection) vs AC line input voltage

10.6 ESD immunity (EN61000-4-2)

Pass [special level (±18kV) for contact discharge].

10.7 Surge immunity (EN61000-4-5)

Pass [Installation class 3, 2kV (line to earth) and 1kV (line to line)].

Test results

10.8 Conducted emissions (EN55022 class B)

The conducted EMI was measured by Schaffner (SMR25503) and followed the test standard of EN55022 (CISPR 22) class B. The evaluation board was set up at maximum load (12W) with input voltage of 115Vac and 230Vac.

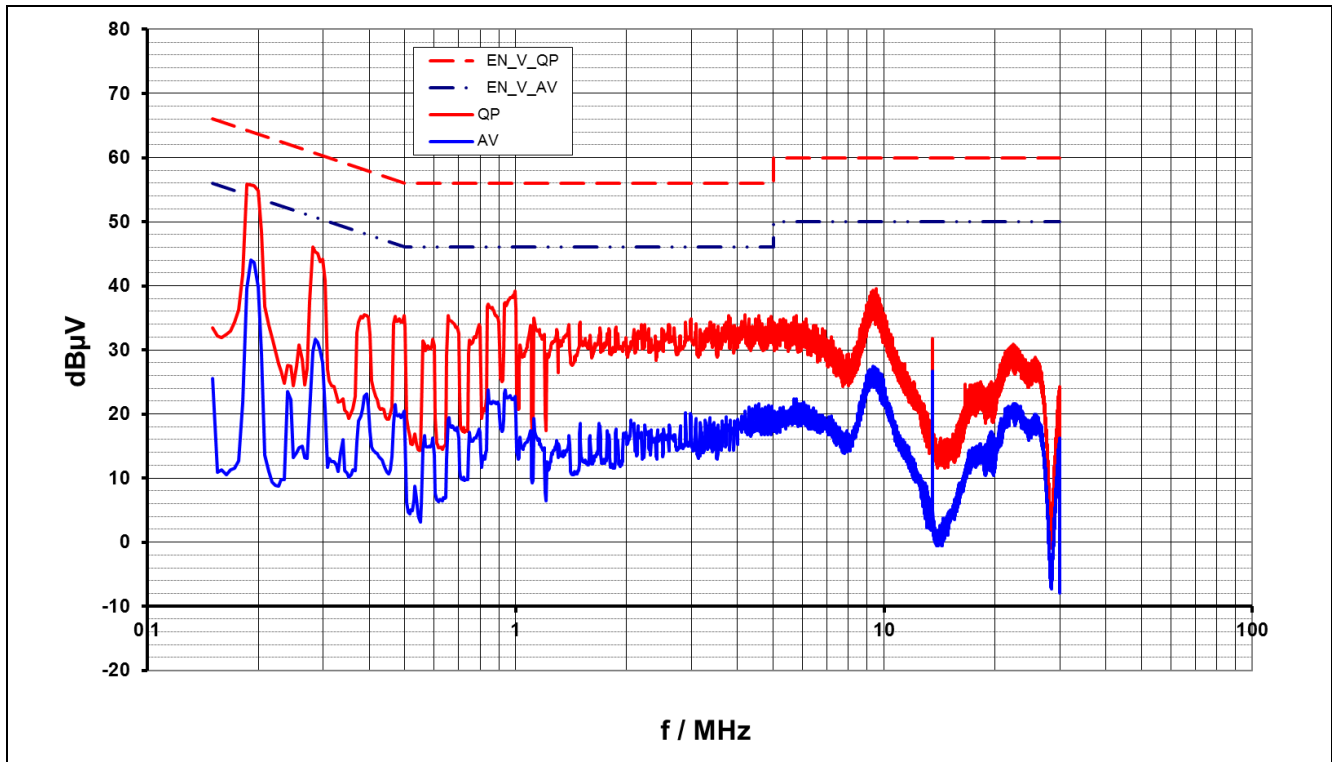

Figure 12 Conducted emissions(Line) at 115Vac and maximum Load

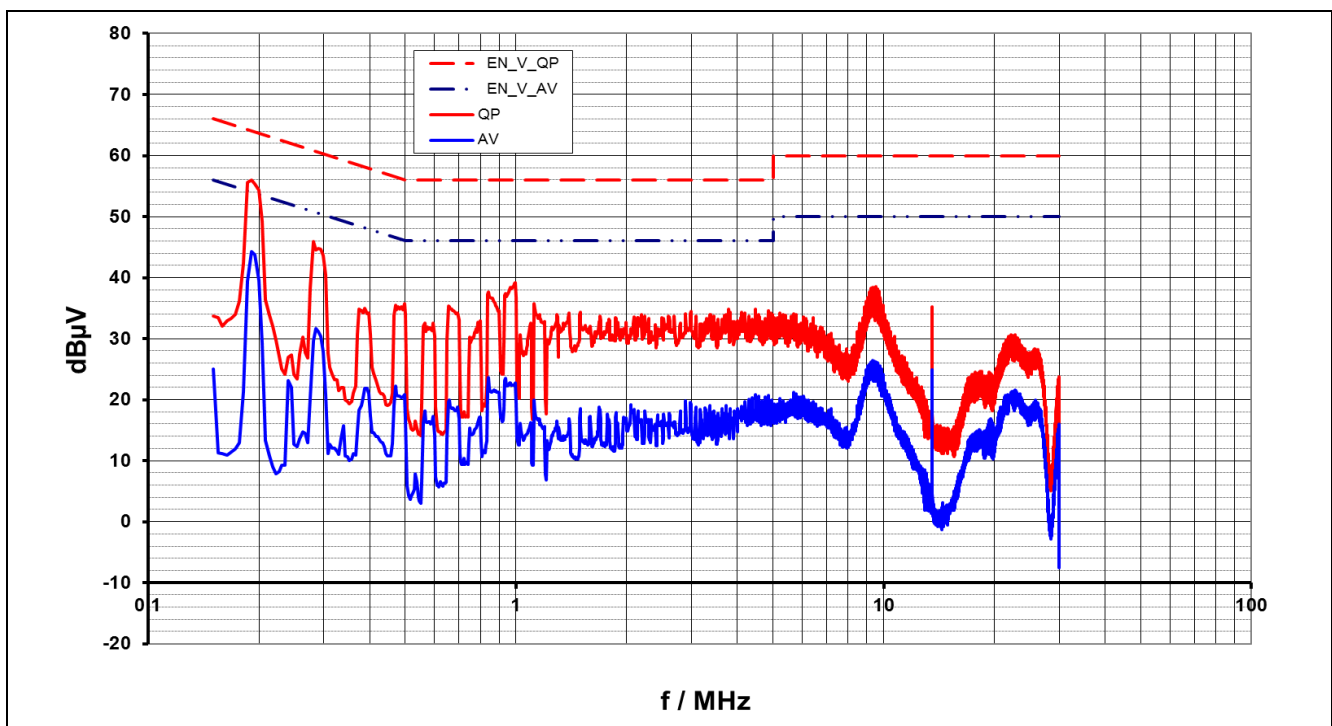

Figure 13 Conducted emissions(Neutral) at 115Vac and maximum Load

Test results

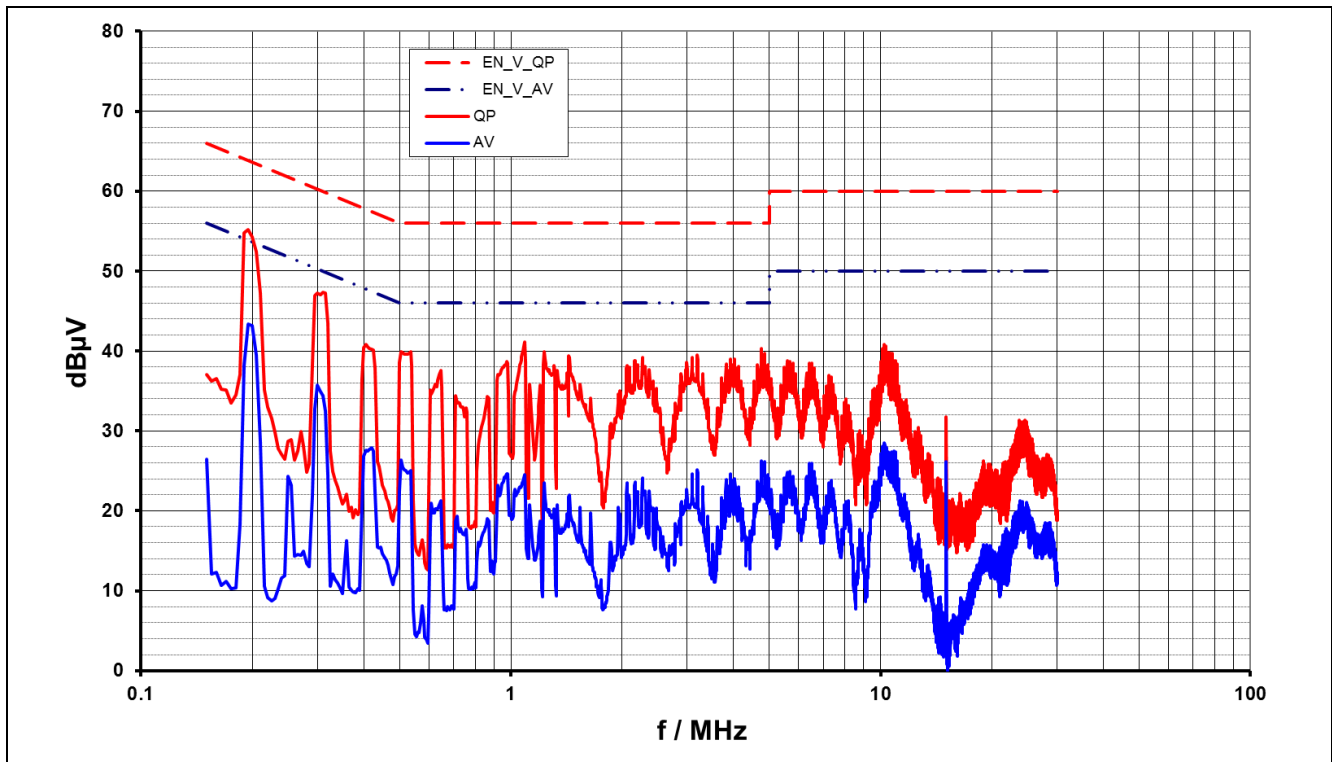

Figure 14 Conducted emissions(line) at 230Vac and maximum Load

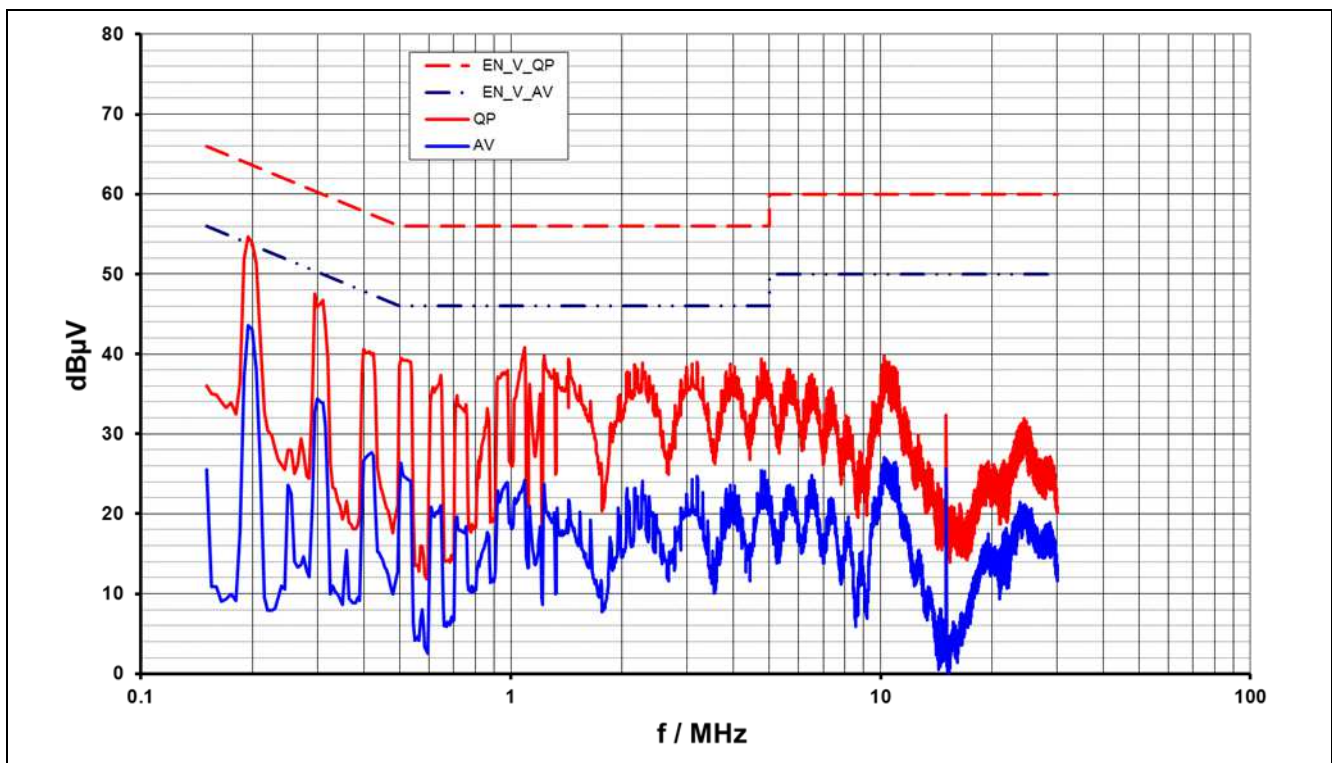

Figure 15 Conducted emissions(Neutral) at 230Vac and maximum Load

Pass conducted EMI EN55022 (CISPR 22) class B with > 7dB margin for QP.

Test results

10.9 Thermal measurement

The thermal test of open frame evaluation board was done using an infrared thermography camera (TVS-500EX) at ambient temperature 25°C. The measurements were taken after two hours running at full load (12W).

No.	Major component	85Vac (°C)	115Vac (°C)	230Vac (°C)	265Vac (°C)
1	IC11 (ICE3AR4780VJZ)	57.5	50.7	49.9	50.7
2	BR1	46.9	40.2	33.6	33.1
3	L11	44.0	39.1	32.3	31.6
4	TR1	51.5	51.4	53.3	53.9
5	D21	54.2	54	54.5	54.9

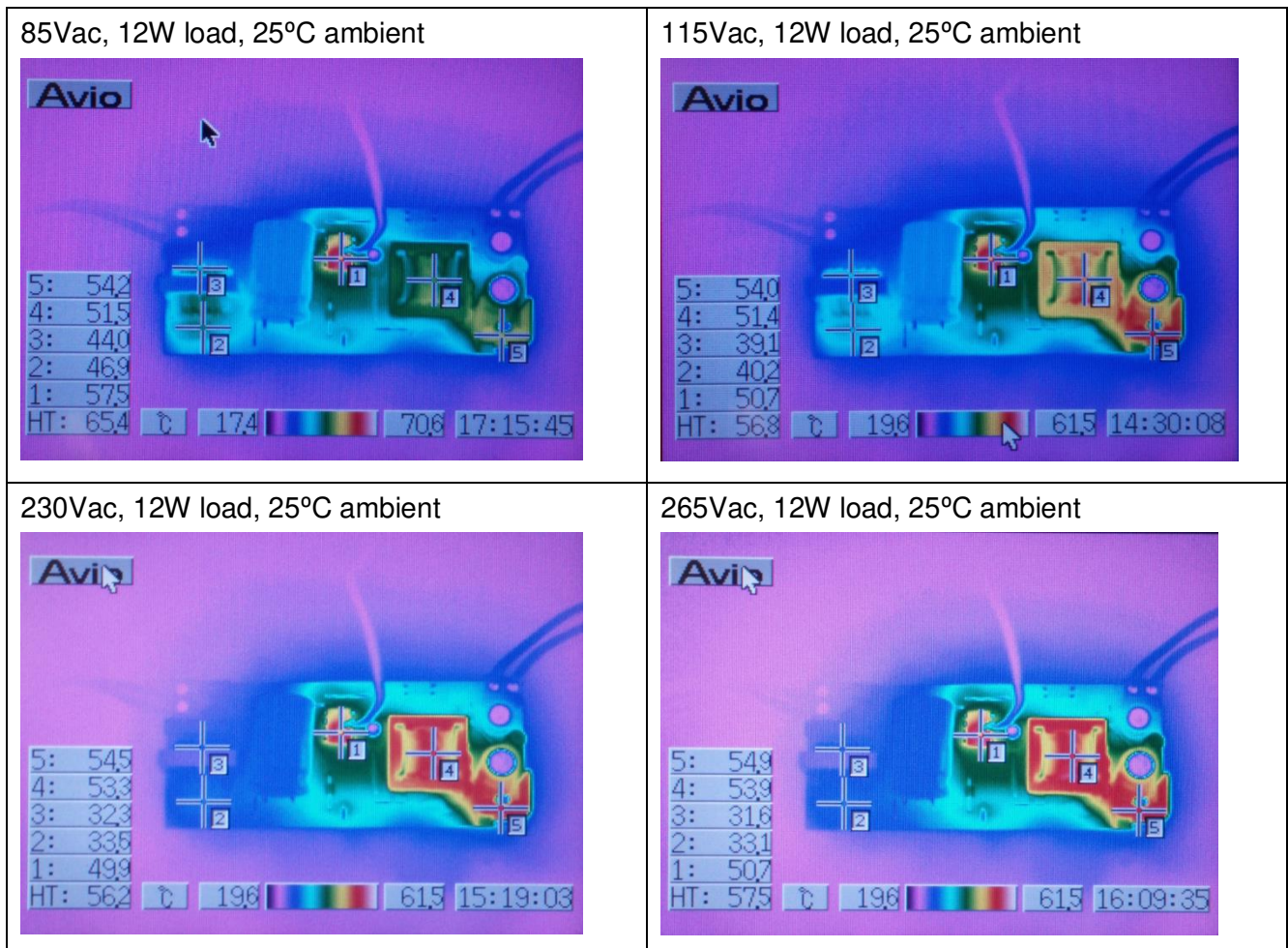

Figure 16 Infrared thermal image of EVAL-ICE3AR4780VJZ



Waveforms and scope plots

# 11 Waveforms and scope plots

All waveforms and scope plots were recorded with a LeCroy 6050 oscilloscope

## 11.1 Start up at low/high AC line input voltage with maximum load

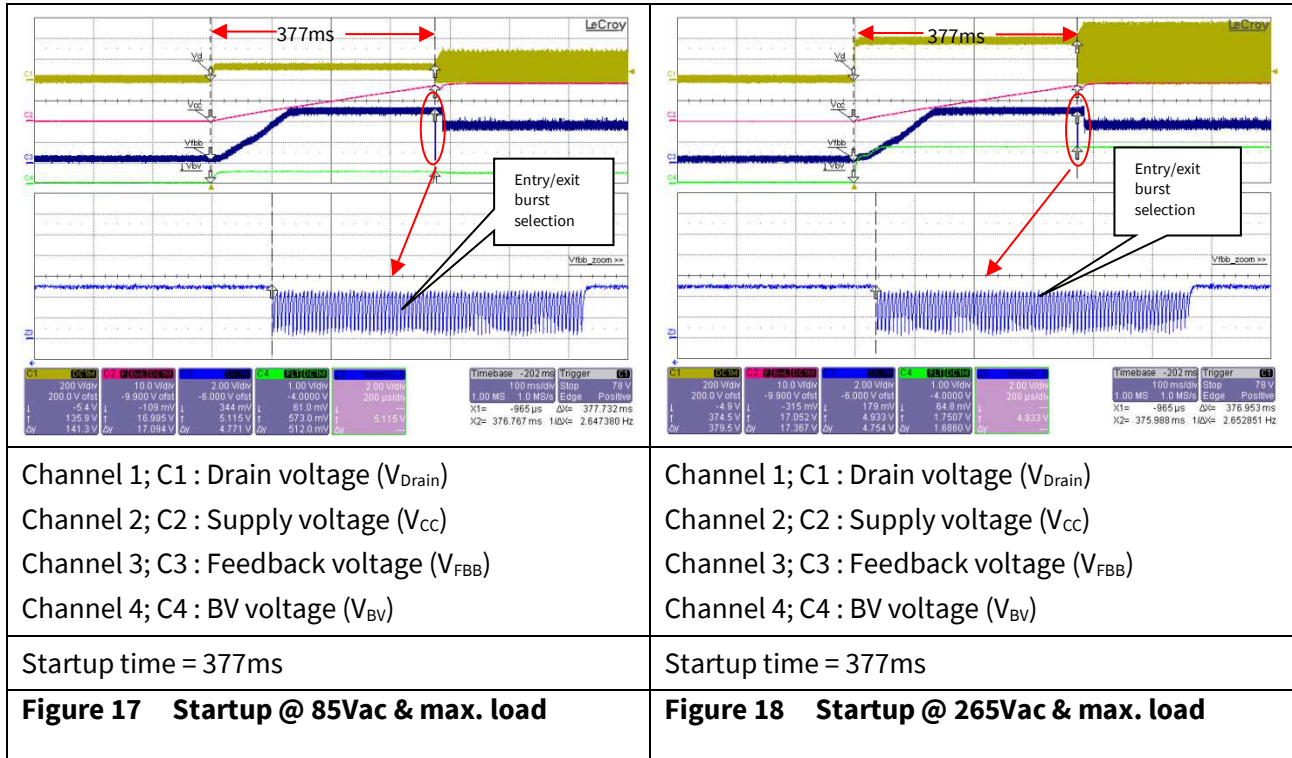

## 11.2 Soft start

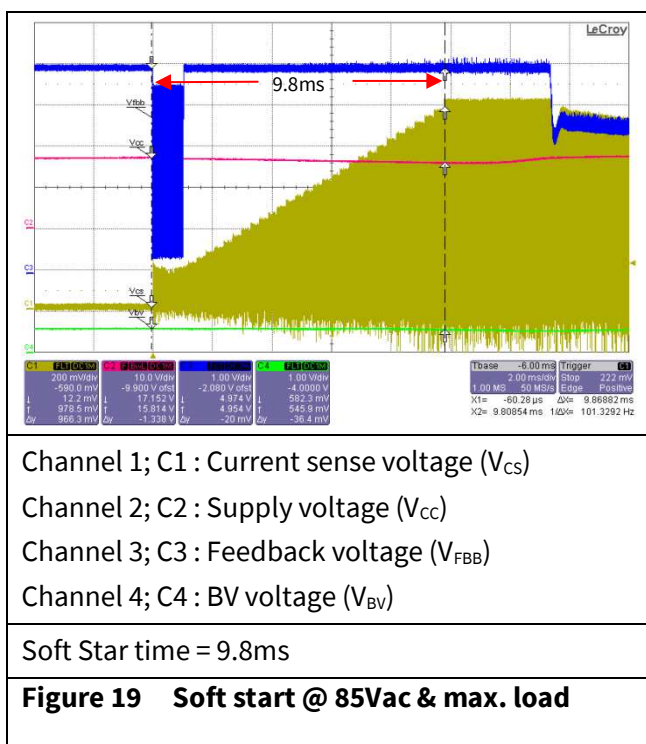

Waveforms and scope plots

11.3 Frequency jittering

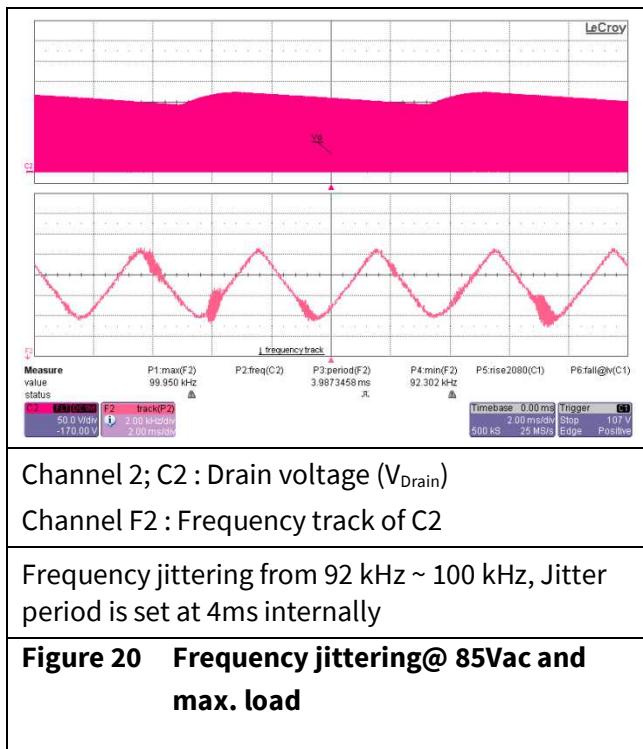

11.4 Drain voltage and current at maximum load

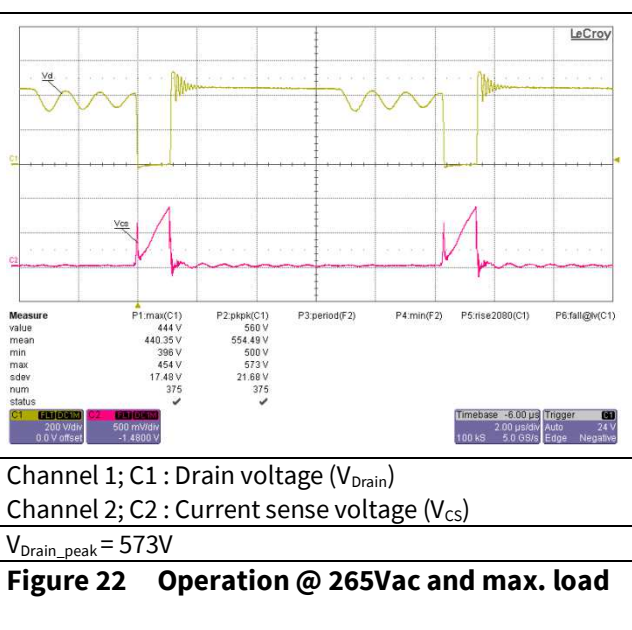
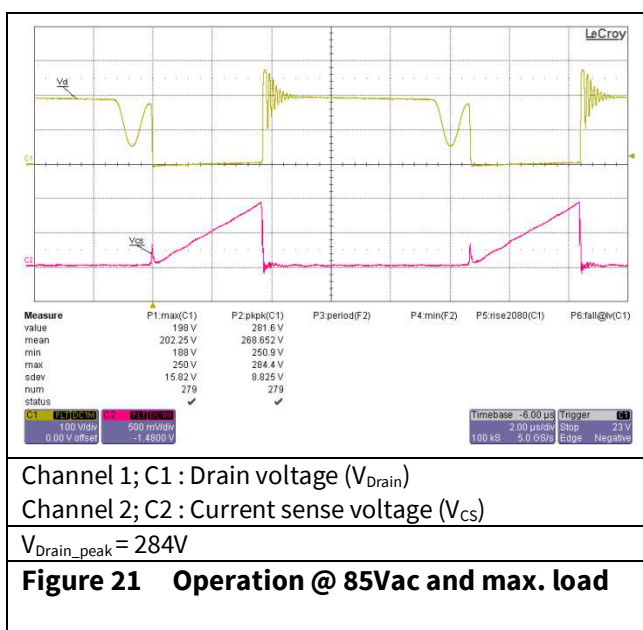

Waveforms and scope plots

11.5 Load transient response (Dynamic load from 10% to 100%)

<p>Channel 1; C1 : Output ripple voltage (Vo) Channel 2; C2 : Output current (Io)</p>	<p>Channel 1; C1 : Output ripple voltage (Vo) Channel 2; C2 : Output current (Io)</p>
<p><math>V_{ripple\_pk\_pk}=220mV</math> (Load change from 10% to 100%, 100Hz, 0.4A/<math>\mu</math>S slew rate) Probe terminal end with decoupling capacitor of 0.1<math>\mu</math>F (ceramic) &amp; 1<math>\mu</math>F (Electrolytic), 20MHz filter</p>	<p><math>V_{ripple\_pk\_pk}=220mV</math> (Load change from 10% to 100%, 100Hz, 0.4A/<math>\mu</math>S slew rate) Probe terminal end with decoupling capacitor of 0.1<math>\mu</math>F (ceramic) &amp; 1<math>\mu</math>F (Electrolytic), 20MHz filter</p>
<p><b>Figure 23 - Load transient response @ 85Vac</b></p>	<p><b>Figure 24 Load transient response @ 265Vac</b></p>

11.6 Output ripple voltage at maximum load

<p>Channel 1; C1 : Output ripple voltage (Vo) Channel 2; C2 : Output current (Io)</p>	<p>Channel 1; C1 : Output ripple voltage (Vo) Channel 2; C2 : Output current (Io)</p>
<p><math>V_{ripple\_pk\_pk}=16mV</math> Probe terminal end with decoupling capacitor of 0.1<math>\mu</math>F (ceramic) &amp; 1<math>\mu</math>F (Electrolytic), 20MHz filter</p>	<p><math>V_{ripple\_pk\_pk}=16mV</math> Probe terminal end with decoupling capacitor of 0.1<math>\mu</math>F (ceramic) &amp; 1<math>\mu</math>F (Electrolytic), 20MHz filter</p>
<p><b>Figure 25 AC output ripple @ 85Vac and max. load</b></p>	<p><b>Figure 26 AC output ripple @ 265Vac and max. load</b></p>

Waveforms and scope plots

11.7 Output ripple voltage during burst mode at 1 W load

<p>Channel 1; C1 : Output ripple voltage (Vo) Channel 2; C2 : Output current (Io)</p>	<p>Channel 1; C1 : Output ripple voltage (Vo) Channel 2; C2 : Output current (Io)</p>
<p><math>V_{ripple\_pk\_pk} = 25mV</math> Probe terminal end with decoupling capacitor of 0.1<math>\mu</math>F(ceramic) &amp; 1<math>\mu</math>F(Electrolytic), 20MHz filter</p>	<p><math>V_{ripple\_pk\_pk} = 18mV</math> Probe terminal end with decoupling capacitor of 0.1<math>\mu</math>F(ceramic) &amp; 1<math>\mu</math>F(Electrolytic), 20MHz filter</p>
<p><b>Figure 27 AC output ripple @ 85Vac and 1W load</b></p>	<p><b>Figure 28 AC output ripple @ 265Vac and 1W load</b></p>

11.8 Active Burst mode operation

<p>Channel 1; C1 : Current sense voltage (<math>V_{CS}</math>) Channel 2; C2 : Supply voltage (<math>V_{CC}</math>) Channel 3; C3 : Feedback voltage (<math>V_{FBB}</math>) Channel 4; C4 : BV voltage (<math>V_{BV}</math>)</p>	<p>Channel 1; C1 : Current sense voltage (<math>V_{CS}</math>) Channel 2; C2 : Supply voltage (<math>V_{CC}</math>) Channel 3; C3 : Feedback voltage (<math>V_{FBB}</math>) Channel 4; C4 : BV voltage (<math>V_{BV}</math>)</p>
<p>Condition: <math>V_{FB} &lt; 1.27V</math> &amp; last for 20ms (load change form full load to 0.5W load)</p>	<p>Condition: <math>V_{FB} &gt; 4.5V</math> (load change form 0.5W load to full load)</p>
<p><b>Figure 29 Entering active burst mode @ 85Vac</b></p>	<p><b>Figure 30 Leaving active burst mode @ 85Vac</b></p>



Waveforms and scope plots

11.9 V<sub>CC</sub> over voltage protection (Odd skip auto restart mode)

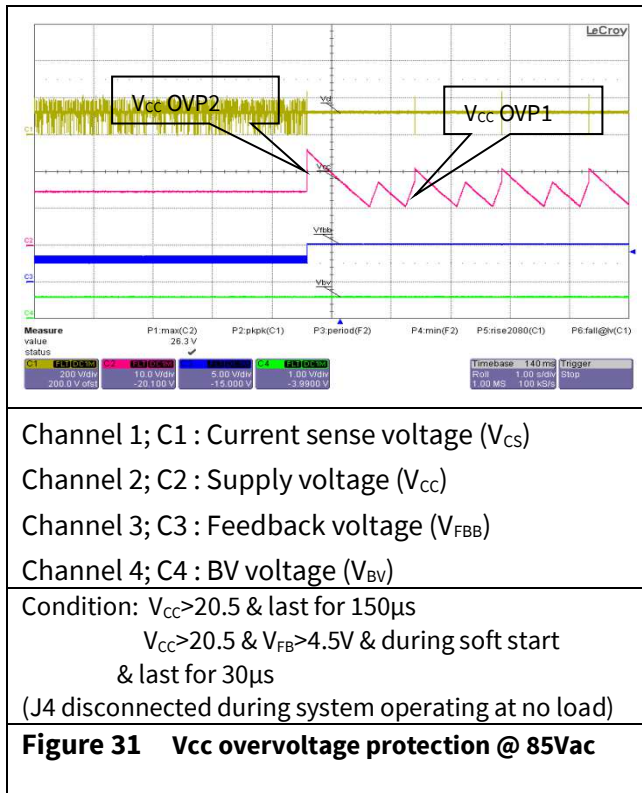

11.10 Over load protection (Auto restart mode)

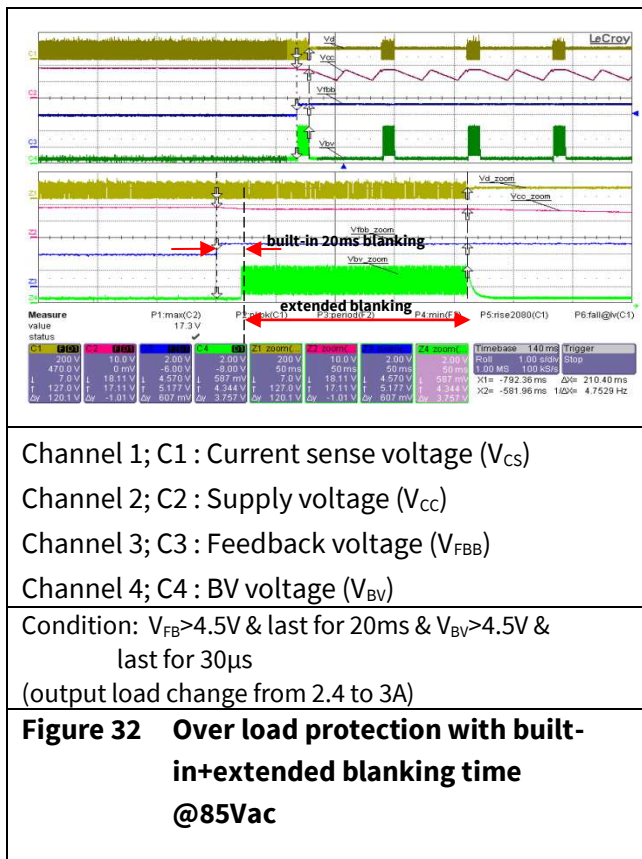



Waveforms and scope plots

**11.11  $V_{CC}$  under voltage/Short optocoupler protection (Normal auto restart mode)**

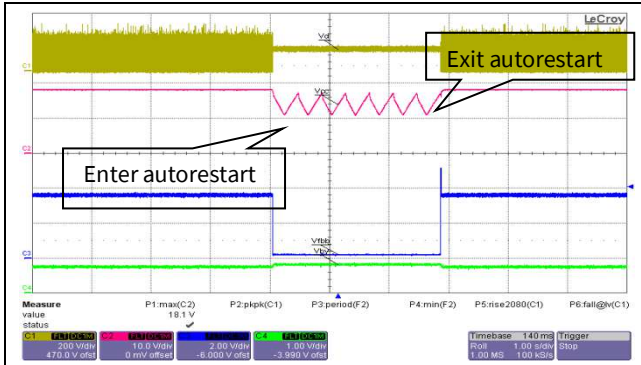

Channel 1; C1 : Current sense voltage ( $V_{CS}$ )  
 Channel 2; C2 : Supply voltage ( $V_{CC}$ )  
 Channel 3; C3 : Feedback voltage ( $V_{FB}$ )  
 Channel 4; C4 : BV voltage ( $V_{BV}$ )

Condition:  $V_{CC} < 10.5V$   
 (short the transistor of optocoupler during system operating @ full load and release)

**Figure 33  $V_{CC}$  under voltage/short optocoupler protection @ 85Vac**

**11.12 AC Line input OVP mode**

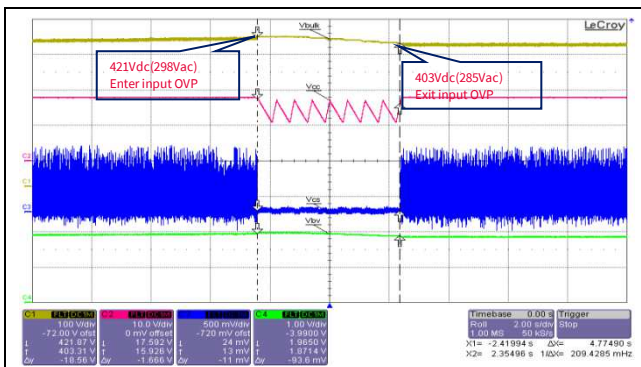

Channel 1; C1 : Bulk voltage ( $V_{bulk}$ )  
 Channel 2; C2 : Supply voltage ( $V_{CC}$ )  
 Channel 3; C3 : Current sense voltage ( $V_{CS}$ )  
 Channel 4; C4 : BV voltage ( $V_{BV}$ )

Condition:  $V_{BV} > 1.98V$  & last for  $400\mu s$  (OVP detect)  
 $V_{BV} < 1.91V$  & last for  $5\mu s$  (OVP reset)  
 (gradually increase AC line voltage until OVP detect and decrease AC line until OVP reset)

**Figure 34 Input OVP mode at max. load condition**

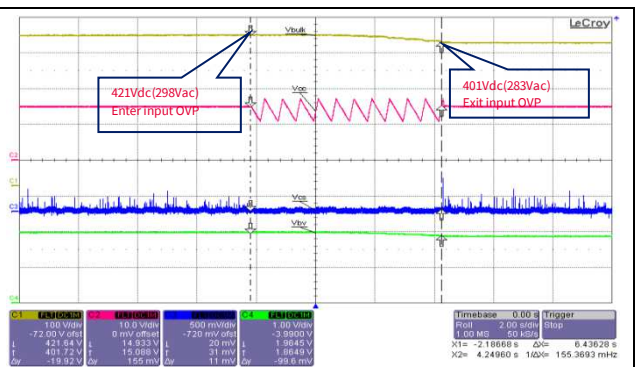

Channel 1; C1 : Bulk voltage ( $V_{bulk}$ )  
 Channel 2; C2 : Supply voltage ( $V_{CC}$ )  
 Channel 3; C3 : Current sense voltage ( $V_{CS}$ )  
 Channel 4; C4 : BV voltage ( $V_{BV}$ )

Condition:  $V_{BV} > 1.98V$  & last for  $400\mu s$  (OVP detect)  
 $V_{BV} < 1.91V$  & last for  $5\mu s$  (OVP reset)  
 (gradually increase AC line voltage until OVP detect and decrease AC line until OVP reset)

**Figure 35 Input OVP mode at no load condition**



## References

## 12 References

- [1] Infineon Technologies, Datasheet “CoolSET™-F3R80 ICE3AR4780VJZ Off-Line SMPS Current Mode Controller with integrated 800V CoolMOS™and Startup cell( input OVP & Frequency Jitter) in DIP-7”
- [2] Infineon Technologies, AN-PS0044-CoolSET F3R80 DIP-7 brownout/input OVP & frequency jitter version design guide-V1.5

## Revision History

### Major changes since the last revision

Page or Reference	Description of change
5	Add section 5.3 under circuit description

#### Trademarks of Infineon Technologies AG

AURIX™, C166™, CanPAK™, CIPOS™, CIPURSE™, CoolMOS™, CoolSET™, CORECONTROL™, CROSSAVE™, DAVE™, DI-POL™, EasyPIM™, EconoBRIDGE™, EconoDUAL™, EconoPIM™, EconoPACK™, EiceDRIVER™, eupec™, FCOS™, HITFET™, HybridPACK™, I<sup>2</sup>RF™, ISOFACE™, IsoPACK™, MIPAQ™, ModSTACK™, my-d™, NovalithIC™, OptiMOS™, ORIGA™, POWERCODE™, PRIMARION™, PrimePACK™, PrimeSTACK™, PRO-SIL™, PROFET™, RASIC™, ReverSave™, SatRIC™, SIEGET™, SINDRION™, SIPMOS™, SmartLEWIS™, SOLID FLASH™, TEMPFET™, thinQ!™, TRENCHSTOP™, TriCore™.

#### Other Trademarks

Advance Design System™ (ADS) of Agilent Technologies, AMBA™, ARM™, MULTI-ICE™, KEIL™, PRIMECELL™, REALVIEW™, THUMB™, μVision™ of ARM Limited, UK. AUTOSAR™ is licensed by AUTOSAR development partnership. Bluetooth™ of Bluetooth SIG Inc. CAT-iq™ of DECT Forum. COLOSSUS™, FirstGPS™ of Trimble Navigation Ltd. EMV™ of EMVCo, LLC (Visa Holdings Inc.). EPCOS™ of Epcos AG. FLEXGO™ of Microsoft Corporation. FlexRay™ is licensed by FlexRay Consortium. HYPERTERMINAL™ of Hilgraeve Incorporated. IEC™ of Commission Electrotechnique Internationale. IrDA™ of Infrared Data Association Corporation. ISO™ of INTERNATIONAL ORGANIZATION FOR STANDARDIZATION. MATLAB™ of MathWorks, Inc. MAXIM™ of Maxim Integrated Products, Inc. MICROTEC™, NUCLEUS™ of Mentor Graphics Corporation. MIPI™ of MIPI Alliance, Inc. MIPS™ of MIPS Technologies, Inc., USA. muRata™ of MURATA MANUFACTURING CO., MICROWAVE OFFICE™ (MWO) of Applied Wave Research Inc., OmniVision™ of OmniVision Technologies, Inc. Openwave™ Openwave Systems Inc. RED HAT™ Red Hat, Inc. RFMD™ RF Micro Devices, Inc. SIRIUS™ of Sirius Satellite Radio Inc. SOLARIS™ of Sun Microsystems, Inc. SPANSION™ of Spansion LLC Ltd. Symbian™ of Symbian Software Limited. TAIYO YUDEN™ of Taiyo Yuden Co. TEAKLITE™ of CEVA, Inc. TEKTRONIX™ of Tektronix Inc. TOKO™ of TOKO KABUSHIKI KAISHA TA. UNIX™ of X/Open Company Limited. VERILOG™, PALLADIUM™ of Cadence Design Systems, Inc. VLYNQ™ of Texas Instruments Incorporated. VXWORKS™, WIND RIVER™ of WIND RIVER SYSTEMS, INC. ZETEX™ of Diodes Zetex Limited.  
Last Trademarks Update 2011-11-11

[www.infineon.com](http://www.infineon.com)

**Edition 2015-05-12**

**Published by**

**Infineon Technologies AG**

**81726 Munich, Germany**

**© 2015 Infineon Technologies AG.**

**All Rights Reserved.**

**Do you have a question about any aspect of this document?**

**Email: [erratum@infineon.com](mailto:erratum@infineon.com)**

**Document reference**

**AN\_201406\_PL21\_004**

#### Legal Disclaimer

THE INFORMATION GIVEN IN THIS APPLICATION NOTE (INCLUDING BUT NOT LIMITED TO CONTENTS OF REFERENCED WEBSITES) IS GIVEN AS A HINT FOR THE IMPLEMENTATION OF THE INFINEON TECHNOLOGIES COMPONENT ONLY AND SHALL NOT BE REGARDED AS ANY DESCRIPTION OR WARRANTY OF A CERTAIN FUNCTIONALITY, CONDITION OR QUALITY OF THE INFINEON TECHNOLOGIES COMPONENT. THE RECIPIENT OF THIS APPLICATION NOTE MUST VERIFY ANY FUNCTION DESCRIBED HEREIN IN THE REAL APPLICATION. INFINEON TECHNOLOGIES HEREBY DISCLAIMS ANY AND ALL WARRANTIES AND LIABILITIES OF ANY KIND (INCLUDING WITHOUT LIMITATION WARRANTIES OF NON-INFRINGEMENT OF INTELLECTUAL PROPERTY RIGHTS OF ANY THIRD PARTY) WITH RESPECT TO ANY AND ALL INFORMATION GIVEN IN THIS APPLICATION NOTE.

#### Information

For further information on technology, delivery terms and conditions and prices, please contact the nearest Infineon Technologies Office ([www.infineon.com](http://www.infineon.com)).

#### Warnings

Due to technical requirements, components may contain dangerous substances. For information on the types in question, please contact the nearest Infineon Technologies Office. Infineon Technologies components may be used in life-support devices or systems only with the express written approval of Infineon Technologies, if a failure of such components can reasonably be expected to cause the failure of that life-support device or system or to affect the safety or effectiveness of that device or system. Life support devices or systems are intended to be implanted in the human body or to support and/or maintain and sustain and/or protect human life. If they fail, it is reasonable to assume that the health of the user or other persons may be endangered.