



Chipsmall Limited consists of a professional team with an average of over 10 year of expertise in the distribution of electronic components. Based in Hongkong, we have already established firm and mutual-benefit business relationships with customers from,Europe,America and south Asia,supplying obsolete and hard-to-find components to meet their specific needs.

With the principle of “Quality Parts,Customers Priority,Honest Operation,and Considerate Service”,our business mainly focus on the distribution of electronic components. Line cards we deal with include Microchip,ALPS,ROHM,Xilinx,Pulse,ON,Everlight and Freescale. Main products comprise IC,Modules,Potentiometer,IC Socket,Relay,Connector.Our parts cover such applications as commercial,industrial, and automotives areas.

We are looking forward to setting up business relationship with you and hope to provide you with the best service and solution. Let us make a better world for our industry!



Contact us

Tel: +86-755-8981 8866 Fax: +86-755-8427 6832

Email & Skype: info@chipsmall.com Web: www.chipsmall.com

Address: A1208, Overseas Decoration Building, #122 Zhenhua RD., Futian, Shenzhen, China



A large, semi-transparent image of a white LED retrofit bulb is centered in the background. The bulb has a circular base and a curved, ribbed body.

Phase Cut Dimmable Isolated Flyback Converter for LED Retrofit Bulb with **ICL8002G & CoolMOS™ 800V CE**

Application Note

Revision 1.1, 2012-08-03

Edition 2012-08-03
Published by
Infineon Technologies AG
81726 Munich, Germany
© 2012 Infineon Technologies AG
All Rights Reserved.

Legal Disclaimer

The information given in this document shall in no event be regarded as a guarantee of conditions or characteristics. With respect to any examples or hints given herein, any typical values stated herein and/or any information regarding the application of the device, Infineon Technologies hereby disclaims any and all warranties and liabilities of any kind, including without limitation, warranties of non-infringement of intellectual property rights of any third party.

Information

For further information on technology, delivery terms and conditions and prices, please contact the nearest Infineon Technologies Office (www.infineon.com).

Warnings

Due to technical requirements, components may contain dangerous substances. For information on the types in question, please contact the nearest Infineon Technologies Office.

Infineon Technologies components may be used in life-support devices or systems only with the express written approval of Infineon Technologies, if a failure of such components can reasonably be expected to cause the failure of that life-support device or system or to affect the safety or effectiveness of that device or system. Life support devices or systems are intended to be implanted in the human body or to support and/or maintain and sustain and/or protect human life. If they fail, it is reasonable to assume that the health of the user or other persons may be endangered.



ICL8002G

Revision History: 2012-08-03, Version 1.1

Previous Version: 1.0

Page	Subjects (major changes since last revision)
15	Add "Production tolerance and distribution"

1	Introduction	5
2	List of Features	5
3	Technical Specification	5
4	Demo Board Design	6
4.1	Demo Board PCBA	6
4.2	Schematic	6
4.3	TRIAC Based Dimmer Compatibility	7
4.4	Single Stage Power Factor Correction	7
4.5	Line Regulation	7
5	Setup and Results	8
5.1	Input / Output	8
5.1.1	Input	8
5.1.2	Output	8
5.2	Power Up	8
5.3	MOSFET Operation Waveforms	9
5.4	Constant Output Power Control	9
5.5	Output Waveforms	11
5.6	Input Waveforms	11
5.7	Phase Cut Dimming	12
5.7.1	Test set-up	12
5.7.2	Waveforms during dimming	12
5.7.3	List of compatible phase cut dimmers	12
5.8	System Efficiency	13
5.9	Protection Functions	14
5.9.1	Output Open Circuit Protection	14
5.9.2	Output Short Circuit Protection	14
5.10	Conducted EMI	14
6	Production Tolerance and Normal Distribution	15
7	Board Layout	16
8	BOM and Transformer Spec	17
8.1	Bill of Material	17
8.2	Transformer	18
9	Design Customization	19
10	Common Questions and Troubleshooting Hints	20
10.1	Q&A	20
10.2	Troubleshooting hints	20
11	References	21

1 Introduction

ICL8002G is a quasi-resonant PWM controller specially designed for high efficient offline LED driving application. It can be configured for different topologies such as flyback and buck converter. This demo board demonstrates its functions in dimmable LED bulb application with isolated flyback topology. Its quasi-resonant operation mode, primary side control, integrated PFC and phase-cut dimming control, and various protections make it an outstanding system solution for dimmable LED bulbs.

Compared with ICL8001G demo board, the new ICL8002G demo board shows significant improvement in terms of dimming performance & output power and hence output current stability. The improvement in compatibility with TRIAC based phase cut dimmers has been achieved by adding damping and bleeding circuit blocks. The output power stability over a wide input voltage range has been increased by an additional line regulation circuit. Despite the additional circuit blocks the BOM still remains in a very competitive range.

This demo board can be ordered with the sales code EVALLED-ICL8002G-B1.

2 List of Features

- Smooth dimming curve with high dimmer compatibility
- High efficiency (>85%) with quasi-resonant flyback operation
- Very high power factor with low THD (<20%)
- Compact single stage design
- Primary side control with high accuracy
- Tight lumen output tolerance
- Integrated power cell for short time to light
- Built-in digital soft-start
- Comprehensive protection functions
- Low system BOM cost for dimmable bulbs

3 Technical Specification

Table 1 lists the performance specification of the EVALLED-ICL8002G-B1 demo board. The input voltage refers to the RMS voltage without modification by means of phase cut dimmer. Since this demo board solution is based on constant power control, the output power is fixed. As a result, the output current is determined by the output voltage, whose range is specified in the table below.

Table 1 Design Specification

Parameter	Value	Unit
Input voltage	196-265	V
Line frequency	50	Hz
Input power	13	W
Output power	11	W
Output voltage	36-42	V
Output current*	300	mA
Power factor	>0.9	
THD	<20%	
Efficiency**	>85%	

*: Actual output current depends on output voltage

** : Efficiency is measured at 230Vac with output of 38V/290mA

4 Demo Board Design

4.1 Demo Board PCBA

Both top and bottom side of the demo board designed with ICL8002G are shown in **Figure 1**.

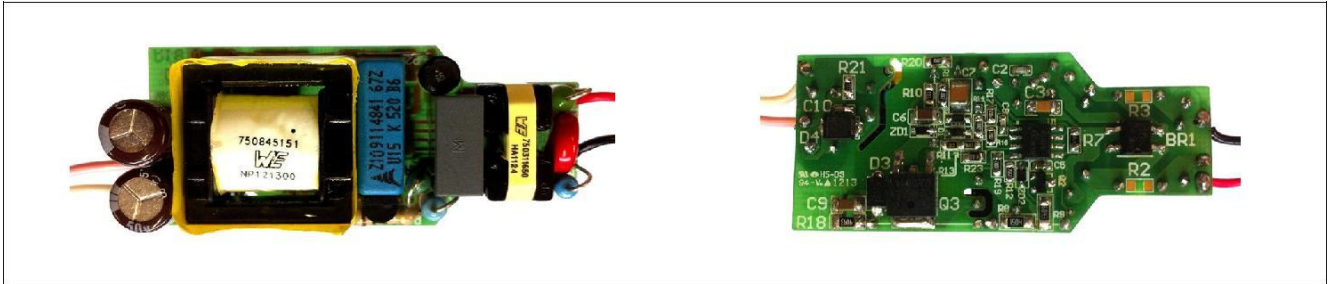

Figure 1 EVALLED-ICL8002G-B1 demo board

4.2 Schematic

Figure 2 shows the schematic for a 13W dimmable LED bulb application designed with ICL8002G.

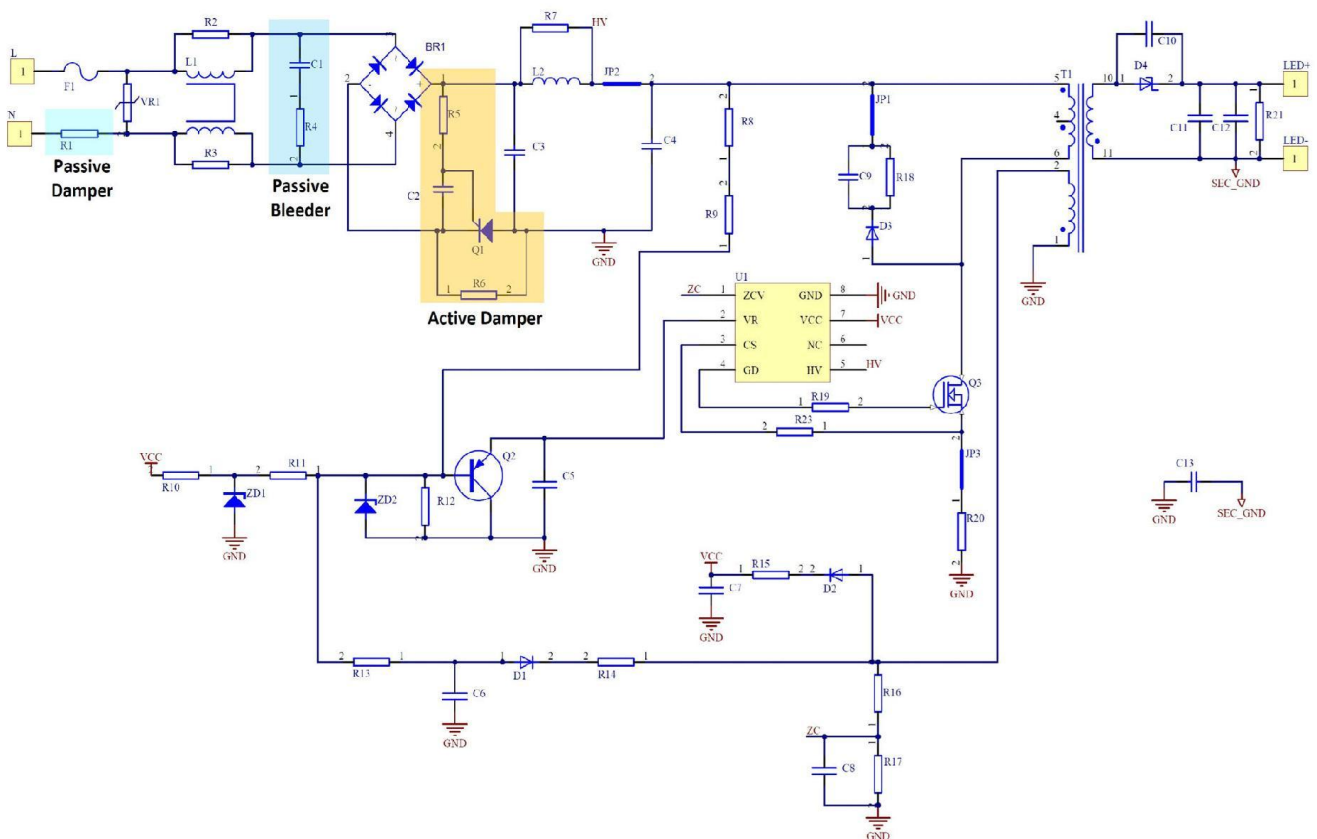

Figure 2 EVALLED-ICL8002G-B1 schematic

4.3 TRIAC Based Dimmer Compatibility

TRIAC based dimmers can work smoothly with resistive loads such as incandescent lamps. When they work with non-resistive loads such as switch mode LED drivers, flickering issue can happen primarily due to insufficient hold-up current as well as current oscillation especially during TRIAC firing. Therefore, to improve the compatibility with TRIAC based dimmers, usually bleeder circuit and damping circuit are implemented in the LED drivers.

In this design, a passive bleeder circuit formed by C1 and R4 is incorporated to maintain input current above the hold-up current threshold of the TRIAC. Two damping resistors, R1 and R6, are used to damp the oscillation as well as reduce inrush current. As the damping resistors can cause significant power loss, they can be bypassed shortly after the TRIAC firing so as to improve efficiency. This is achieved with circuit formed by R5, C2, and thyristor Q1. Each time when TRIAC turns on, due to the time delay produced by R5 and C2, thyristor Q1 will remain off and as a result the inrush current is limited by R6. When Q1's gate voltage is charged to its triggering level, it will turn on and bypass R6. Thereafter Q1 will remain in conduction until the current drops below its holding current level at the end of each cycle.

4.4 Single Stage Power Factor Correction

Single stage power factor correction (PFC) helps realizing highly efficient cost effective and compact LED driver design. In this demo board design, PFC is achieved with sensing the input mains voltage (via R8, R9, R12, and Q2 as shown in Figure 3) and regulating the peak current of the primary winding during each switching cycle to be approximately proportional to the voltage-sensing signal at VR pin of ICL8002G. As a result, input current is shaped to be more or less sinusoidal and thus high power factor is achieved, with input current harmonics fulfilling the requirements of EN 61000-3-2 standard.

4.5 Line Regulation

The power factor correction scheme described above also indicates that with higher input voltage, the output power will increase due to higher primary current. To produce a constant power, the primary current should be smaller with higher input voltage. Therefore to produce a stable output power (and lumen output) versus mains voltage variations it is necessary to implement some compensation scheme to achieve good line regulation.

In this design, the line regulation is achieved by the IC's integrated foldback correction function as well as the circuitry formed by R13, C6, D1, and R14. C6, together with D1 and the auxiliary winding of the flyback transformer will produce a negative voltage which is proportional to the rectified input voltage. With choosing proper value of R13, the peak voltage level at the base of Q2, and thus VR pin's voltage, will remain more or less constant against line voltage variation. The circuit formed by R10, R11 and ZD1 will add a DC offset to the base of Q2 so as to prevent it from going down to negative voltage. It will also determine the peak level of VR's voltage and in turn determine the output power. The ZCV pin is able to detect the input voltage through R16 and the auxiliary winding and this allows IC to vary primary current sense voltage limit according to the input voltage. This means the primary current will be decreased when the input voltage increases. The extent of the compensation can be adjusted with varying the value of R16.

Fine tuning of resistance value of R13 is necessary to provide optimum compensation to the line variation. As a rule of thumb, R13 can be calculated with the following formula.

$$R13 \approx (R8 + R9) * \frac{N_{aux}}{N_p} \quad (1)$$

where N_{aux} and N_p are the number of turns of the auxiliary winding and the primary winding respectively.

5 Setup and Results



ATTENTION: LETHAL VOLTAGES ARE PRESENT ON THIS DEMO BOARD. DO NOT OPERATE THE BOARD UNLESS YOU ARE TRAINED TO HANDLE HIGH VOLTAGE CIRCUITS. DO NOT LEAVE THIS BOARD UNATTENDED WHEN IT IS POWERED UP.

5.1 Input / Output

5.1.1 Input

Connect AC line (196V-265V) to the red (Live) and black (Neutral) wires. For dimming operation the phase cut dimmer should be connected to the input according to the dimmer's instructions by its manufacturer.

5.1.2 Output

Connect LED module (36V~42V/300mA) to the pink (positive) and white (negative) wires from the demo board.

5.2 Power Up

The ICL8002G integrates a start-up cell to charge up the Vcc capacitor until it starts up successfully. **Figure 3** demonstrates the start-up waveforms from mains voltage switch-on to light output. Start-up time of 350ms for a Vcc capacitance of C7 = 22 μ F is observed.

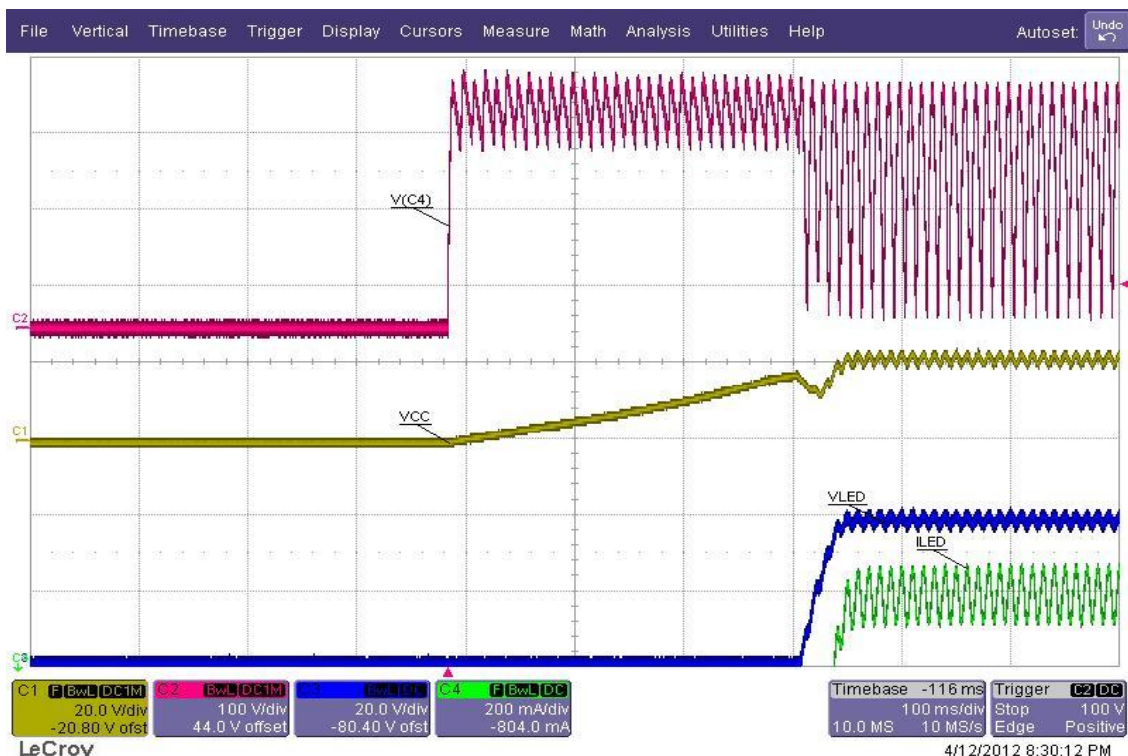

Figure 3 Start-up: Rectified mains input voltage (C2, red), Controller Vcc (C1, yellow), output voltage (C3, blue), and output current (C4, green)

5.3 MOSFET Operation Waveforms

The ICL8002G is a quasi-resonant PWM controller, which will turn on MOSFET when its drain voltage drops to the valley point. This helps to reduce current spike as well as switching loss and thus improve both efficiency and EMI performance. **Figure 4** shows typical switching waveforms of the MOSFET Q1 on the primary side.

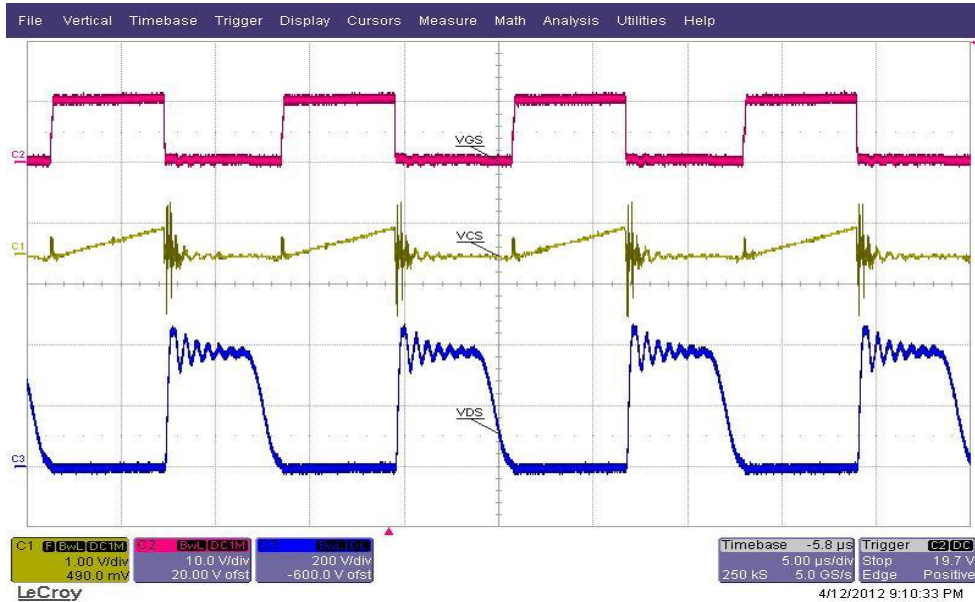

Figure 4 Typical switching waveforms: Gate Drive voltage (C2, red), shunt signal VCS (C1, yellow) and Drain Source Voltage VDS (C3, blue) showing quasi-resonant switching

5.4 Constant Output Power Control

This ICL8002G based single stage flyback solution produces constant output power against input voltage and output voltage variation. For LED bulb application, the output voltage variation is limited as the number of LEDs is fixed and this means the output current is relatively constant. Please refer to **Figure 5** for the measured output power regulation characteristic.

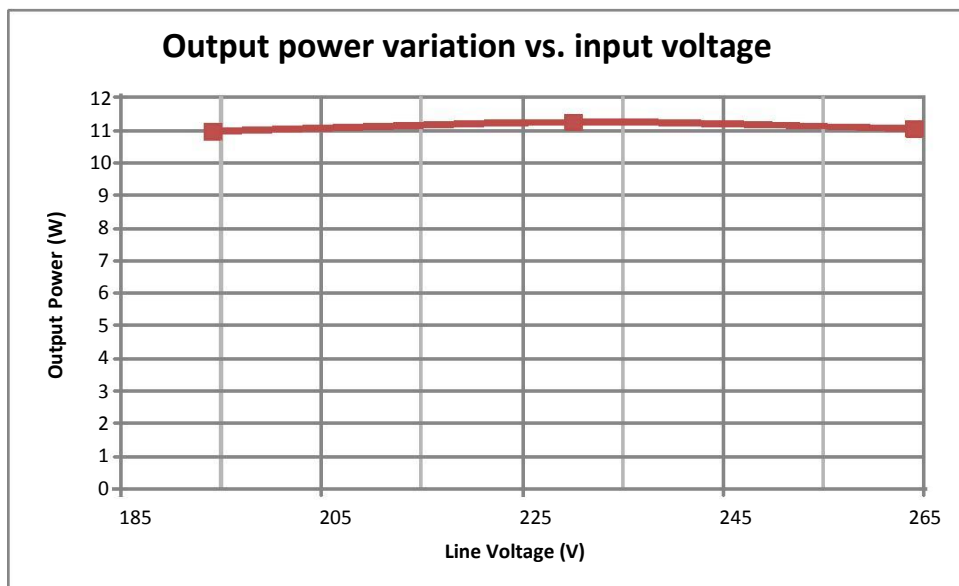

Figure 5 Output power vs. line voltage

With fixed output power, the LED load will operate at the point (current and voltage) where its I-V characteristic curve crosses the constant power curve. **Figure 6** shows how the LED's operating point is determined.

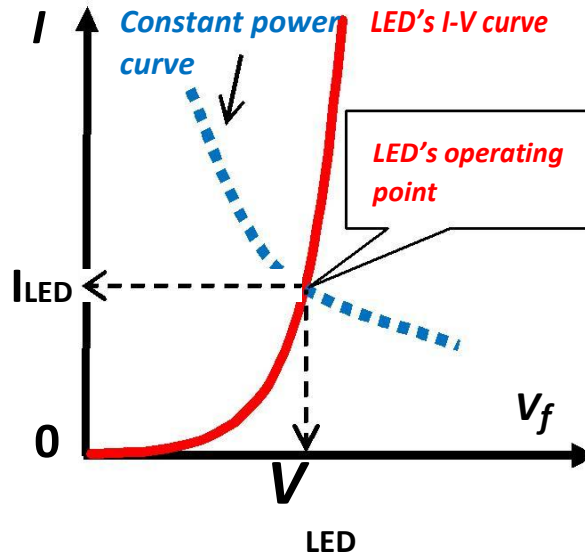

Figure 6 LED operating point with constant power control

Figure 7 shows the measured LED current versus line voltage. The maximum current deviation is limited to -2.5% across the whole input voltage range (196Vac-265Vac).

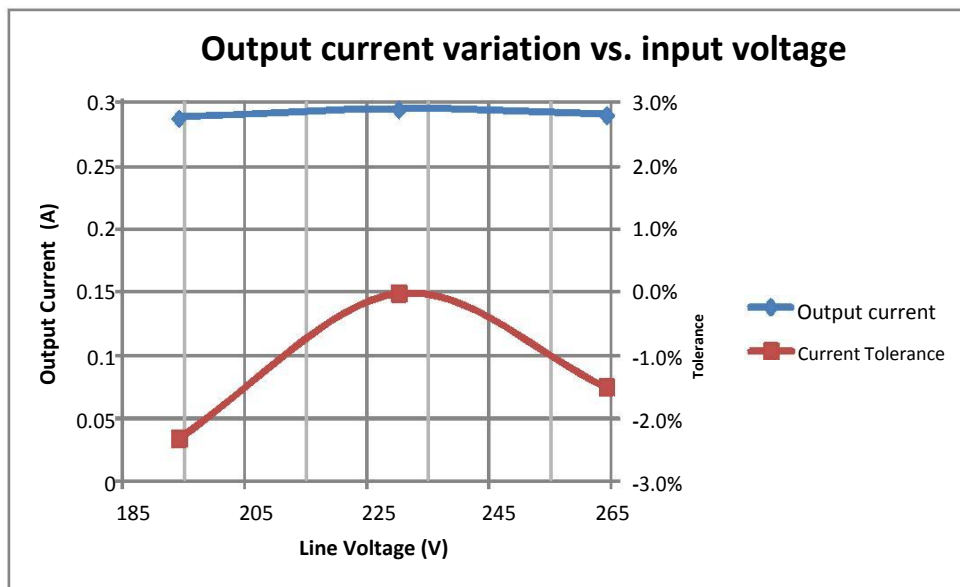

Figure 7 LED current vs. line voltage

Compared with constant current control, which will produce higher output power with higher LED forward voltage, the constant power control allows stable output power regardless of LED forward voltage. As the system thermal design is mainly determined by the output power, high thermal design margin is not necessary due to stable output power. And this enables easy and optimized heatsink design and thus helps reduce system cost. Another benefit of constant power control is that it helps maintain constant lumen output versus LED module's luminous tolerance and temperature variation.

5.5 Output Waveforms

The single stage PFC design inevitably produces double mains frequency ripple at the output. Increasing output capacitance value helps reduce output ripple. However, this is often at the expense of the system's form factor. In this demo board design, the output capacitor (C11 and C12) is sized for an output current ripple which exhibits no visible light modulation. **Figure 8** shows the measured waveforms of output voltage and output current. The modulation depth of the current ripple is about 25%.

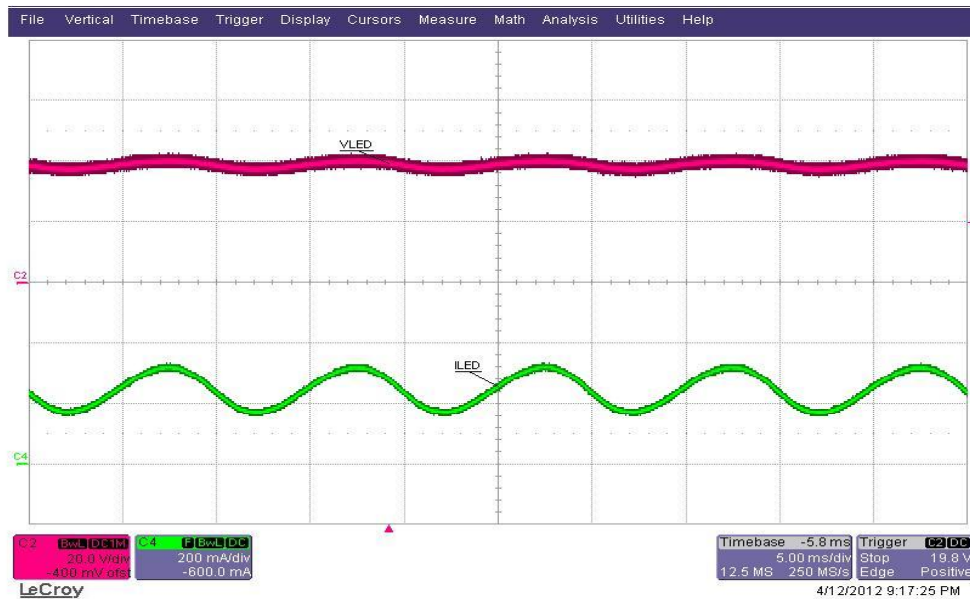

Figure 8 Typical waveforms: Output voltage (C2, red) and output current (C4, green)

5.6 Input Waveforms

Figure 9 shows the waveforms of input voltage, input current, and the current shunt voltage during normal operation at 230Vac and full load. The measured power factor is above 0.93 and the input current harmonics amplitudes fulfil the requirements of EN 61000-3-2 standard.

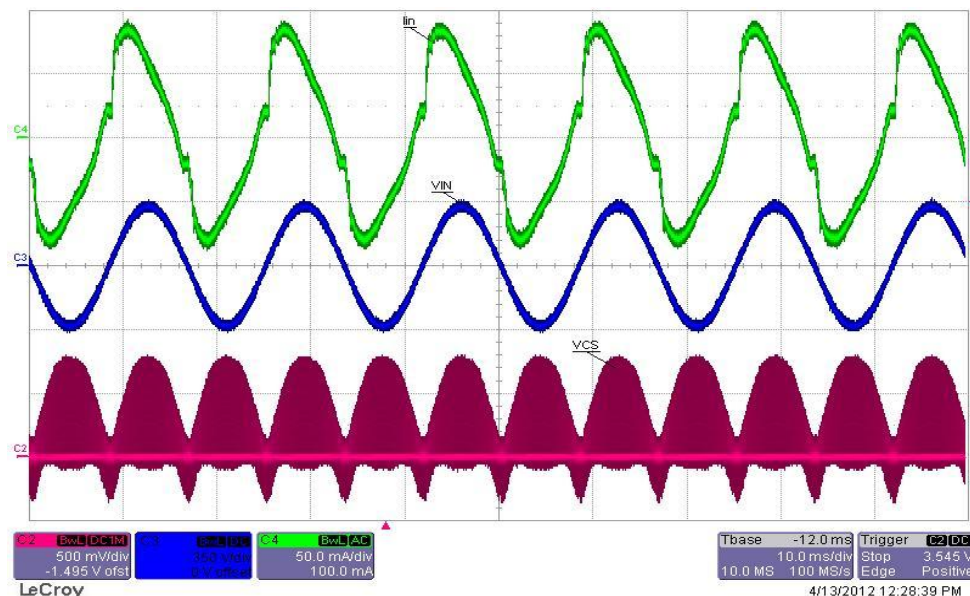

Figure 9 Input voltage V_{in} (C3, blue), Input current I_{in} (C4, green) and shunt voltage V_{cs} (C2, red)

5.7 Phase Cut Dimming

5.7.1 Test set-up

When evaluating dimming performance, the phase cut dimmer should be connected according to [Figure 10](#).

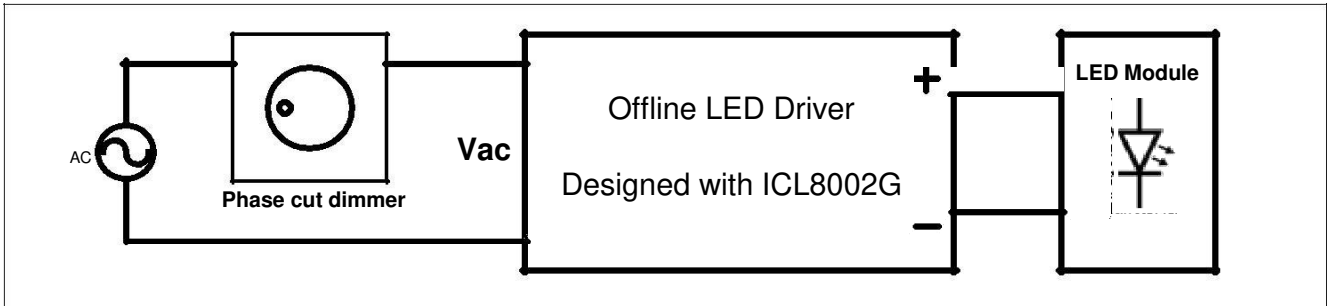

Figure 10 Phase cut dimming arrangement

5.7.2 Waveforms during dimming

[Figure 11](#) shows the waveforms of input voltage, input current, and the LED module's current when the LED driver is operated with a leading edge phase cut dimmer.

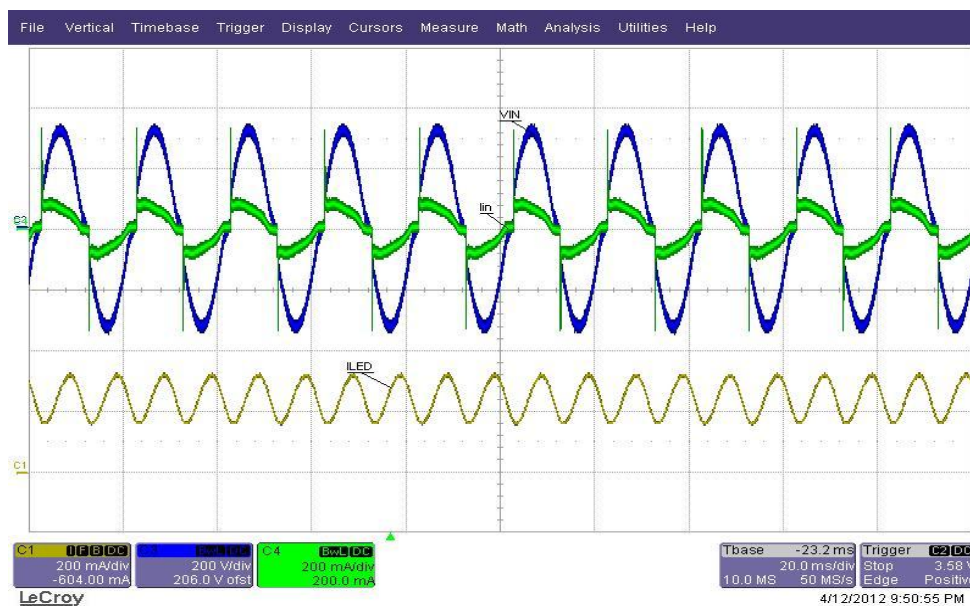

Figure 11 Input voltage V_{in} (C3, blue), Input current I_{in} (C4, green) and LED current (C1, yellow)

5.7.3 List of compatible phase cut dimmers

Some phase cut dimmers tested with flickering free on this demo board are listed in [Table 2](#).

Table 2 Compatible phase cut dimmers tested at input 230 Vac / 13 W

Manufacturer	Model	Type	Power limit	Dimming range
BUSCH JAEGER	2200UJ-212	Leading edge	400 W	21– 100 %
BUSCH JAEGER	2200	Leading edge	400 W	27 – 100 %

Table 2 Compatible phase cut dimmers tested at input 230 Vac / 13 W

Manufacturer	Model	Type	Power limit	Dimming range
BUSCH JAEGER	2247U	Leading edge	500 W	23 – 100 %
BUSCH JAEGER	2250U	Leading edge	600 W	15 – 100 %
CLIPSAL	32E450LM	Leading edge	450 W	11 – 100 %
CLIPSAL	32E450UDM	Trailing edge	450 W	26 – 100 %
CLIPSAL	4062E450UDM	Trailing edge	450 W	26 – 100 %
SIEMENS	5TC8 256	Leading edge	400 W	2 – 100 %
SIEMENS	5TG0752-1NC1	Leading edge	400 W	27 – 100 %
SIEMENS	5UH8022-3NC01	Leading edge	500 W	31 – 100 %
LUMEO	LICHTREGLER T10	Leading edge	300 W	1 – 100 %
TCL	NA	Leading edge	630 W	1 – 100 %
GZQS	NA	Leading edge	630 W	17 – 100 %
NVC	NA	Leading edge	400 W	24 – 100 %
OPPLE	E068101	Leading edge	300 W	1 – 100 %
PDL	CAT634LM	Leading edge	450 W	17 – 100 %
MANK	NA	Leading edge	200 W	24 – 100 %
FLEXALITE	NA	Leading edge	630 W	3 – 100 %
DIGITRAC	NA	Leading edge	400 W	14 – 100 %
HPM	400T	Trailing edge	400 W	1 – 100 %
BERKER	23010	Leading edge	400 W	21 – 100 %
OPUS	852.39	Leading edge	400 W	19 – 100 %

5.8 System Efficiency

Figure 12 shows the LED driver system's efficiency versus line voltage, which exhibits high efficiency (>84%) over the whole input voltage range due to the quasi-resonant operation.

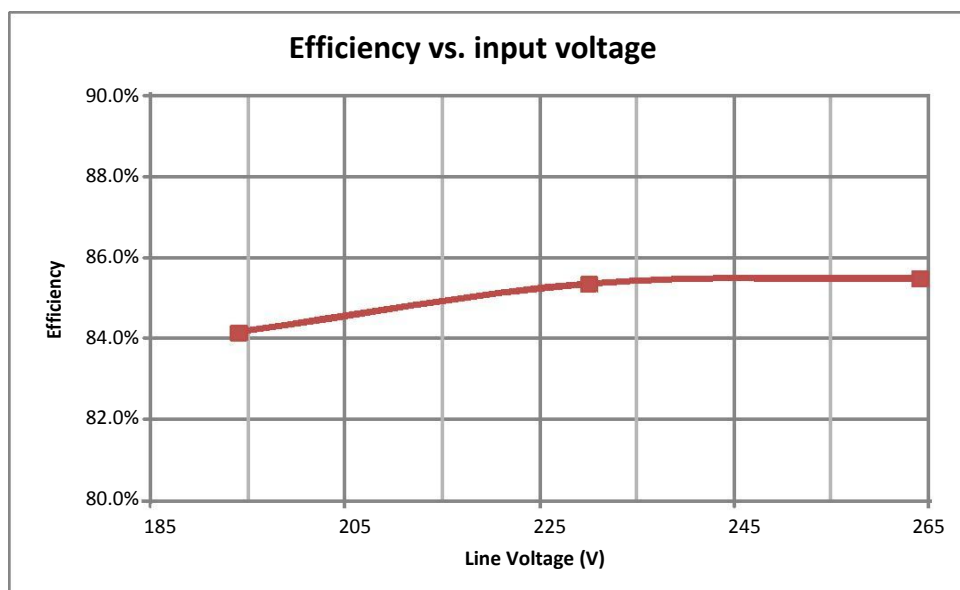

Figure 12 LED Driver efficiency vs. input voltage

5.9 Protection Functions

The protection functions listed in [Table 3](#) are provided with ICL8002G.

Table 3 ICL8002G protection functions

VCC Overvoltage	Auto Restart Mode
VCC Undervoltage	Auto Restart Mode
Output Overvoltage	Latched Off Mode
Output Short Circuit	Auto Restart Mode
Short Winding	Latched Off Mode
Over temperature	Auto Restart Mode

5.9.1 Output Open Circuit Protection

When the output is left open during operation, the output voltage will rise and accordingly the voltage produced by the auxiliary winding when MOSFET turns off will increase. This voltage is detected by ZCV pin of ICL8002G via R16 and R17. Output overvoltage protection will be triggered once this voltage reaches the OVP threshold ($V_{zcovp} = 3.7V$) and IC will go into Latched Off Mode. On the other hand, the voltage produced by the auxiliary winding will supply to Vcc and Vcc overvoltage protection will be triggered if it reaches the threshold ($V_{vccovp} = 25V$). In this demo board design, Vcc overvoltage protection will be triggered when the output is left open and IC will go into Auto Restart Mode. The power consumption during Auto Restart Mode is below 0.5W.

5.9.2 Output Short Circuit Protection

In the case of an output short circuit, the IC will switch to Auto Restart Mode by means of VCC undervoltage detection. Total input power consumption in this mode is kept well below 1W.

5.10 Conducted EMI

The conducted EMI test is performed at 230Vac with full load condition. The EMI's peak value is plotted against quasi-peak limit of the EN55015(CISPR15). There is approximately 10dB margin observed.

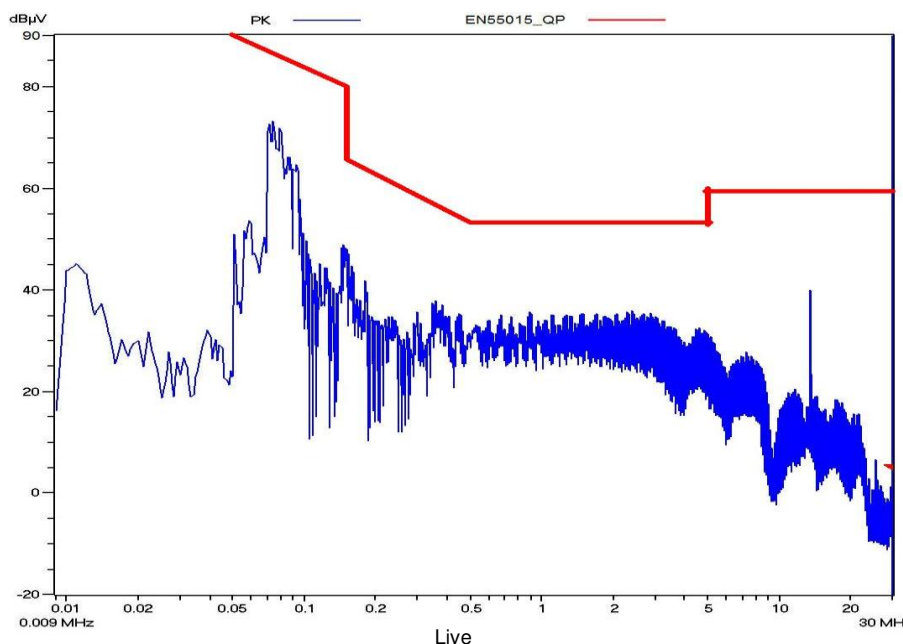

Figure 13 Tested at 230Vac with full load (Live). EN55015 B limit.

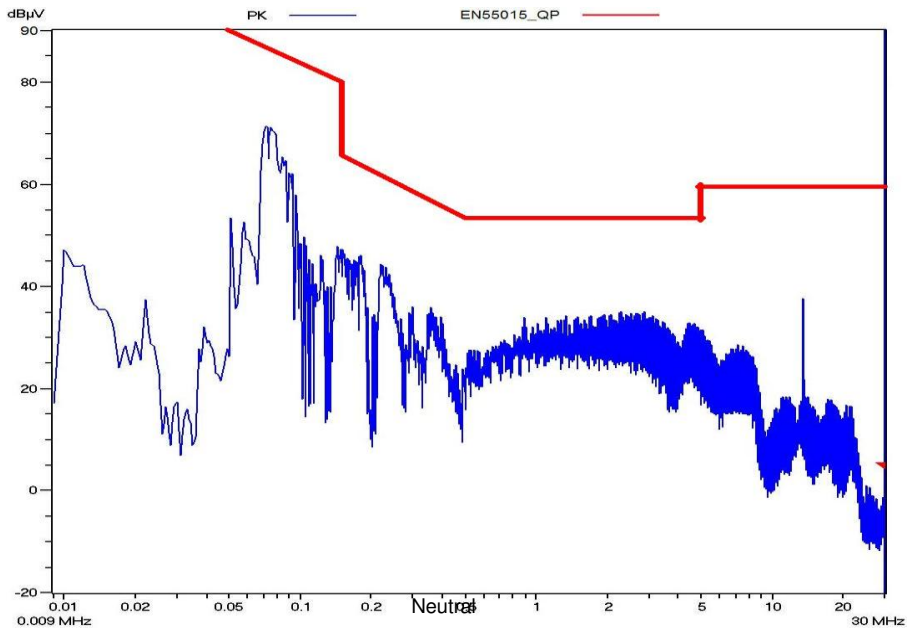

Figure 14 Tested at 230Vac with full load (Neutral). EN55015 B limit.

6 Production Tolerance and Normal Distribution

In total 72 demo board samples have been tested and the output power of each board was recorded at the same test condition (line voltage of 230Vac and ambient temperature of 25°C) to check the production tolerance, which is contributed by both the IC and external components tolerance. **Figure 15** shows the distribution data of output power.

The result indicated that the output power tolerance is within $\pm 3\%$, and standard deviation is 0.15W.

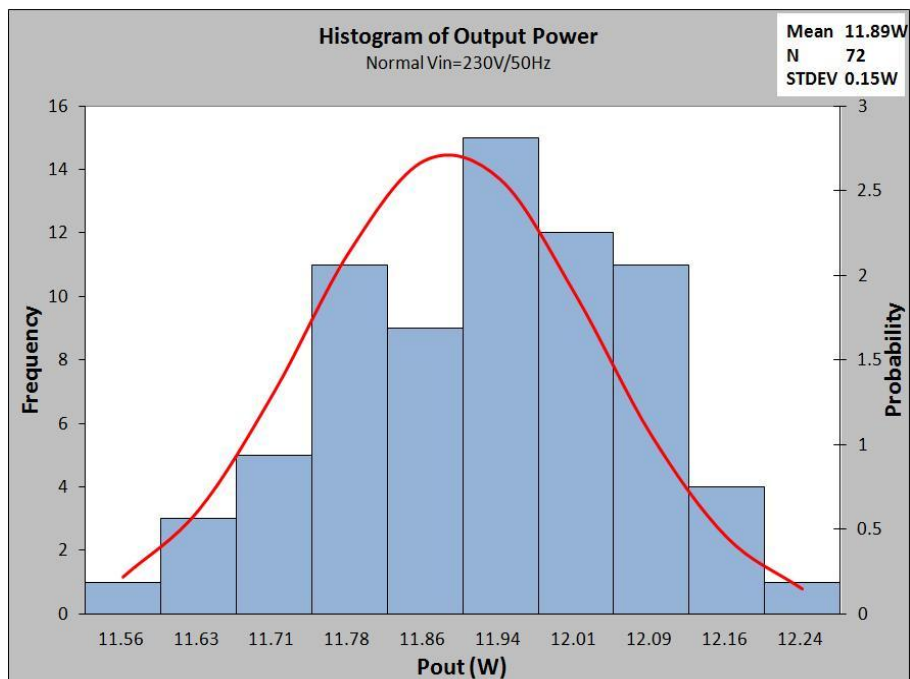

Figure 15 Production variation of output power (board to board deviation)

7 Board Layout

A single layer PCB with 0.8mm thickness is used for this demo board. The maximum height of the demo board (at C11) is 23.2mm. It is able to fit into many different lamp fixtures like A19 bulb and PAR30. This demo board is designed to meet UL safety standard for galvanic isolation but was not submitted for safety certification.

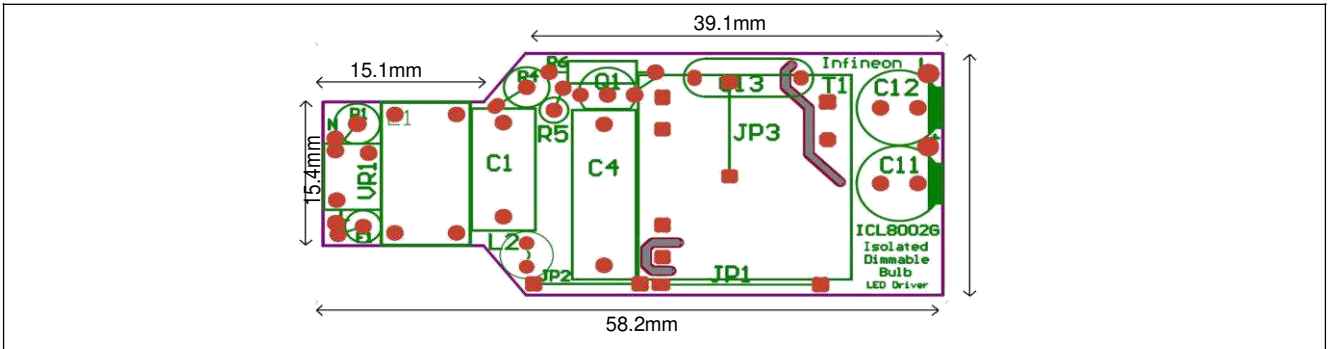

Figure 16 EVALLED-ICL8002G-B1 - Top Layer

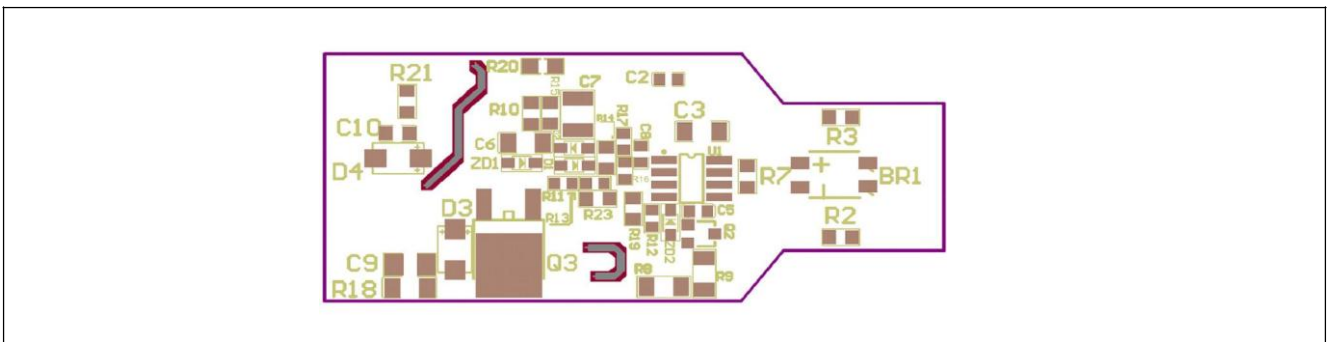

Figure 17 EVALLED-ICL8002G-B1 - Bottom Layer

8 BOM and Transformer Spec

8.1 Bill of Material

						
Number	Reference	Value	Description	Package	Part Number	Manufacturer
1	U1	ICL8002G	LED DRIVER IC	SO8	ICL8002G	INFINEON
2	BR1	600V 0.5A	Bridge Diode	TO-269AA	MB6S-E3/80	VISHAY
3	C1	275VAC 0.15uF	Film Cap, 10mm Pitch		R46KF315000P0M	KEMET
4	C2	50V 150nF	MLCC, X7R	0603	C0603C154K5RACTU	KEMET
5	C3	630V 15nF	MLCC, X7R	1206	GRM31CR72J153KW03L	MURATA
6	C4	520V 0.15uF	Film Cap, 15mm Pitch		B32672Z5154K	EPCOS
7	C5	50V 10nF	MLCC, X7R	0603	GRM188R71H103KA01D	MURATA
8	C6	50V 4.7uF	MLCC, X7R	1206	GRM31CR71H475KA12L	MURATA
9	C7	25V 22uF	MLCC, X7R	1210	GRM32ER71E226KE15L	MURATA
10	C8	50V 330pF	MLCC, X7R	0603	C1608X7R1H331K	TDK
11	C10	250V 1nF	MLCC, X7R	0805	C0805C102KARACTU	KEMET
12	C11	50V 180uF	Electrolytic Cap, Lo=9000H	8 x 20	EEUFR1H181L	PANASONIC
13	C12	50V 120uF	Electrolytic Cap, Lo=8000H	8 x 15	EEUFR1H121L	PANASONIC
14	C13	250VAC 2.2nF	Ceramic Cap, Dielectric Str 4kV		DE1E3KX222M	MURATA
15	D1,D2	75V 0.2A	Switching Diode	SOD323	BAS16HT1G	ONSEMI
16	D4	150V 3A	Schottky Diode	SMB	STPS3150U	ST
17	F1	250V 5A	Fuse, Fast Acting		0263005.MXL	LITTELFUSE
18	JP2, JP3		Jumper, Lead Dia = 0.6mm			
19	L1	45mH 0.18A	Common mode choke		750311650	Würth Elektronik
20	L2	1.5mH 0.19A	Filter Choke		7447462152	Würth Elektronik
21	Q1	600V 0.8A	SCR	TO92	MCR100-8	ONSEMI
22	Q2	45V 0.1A	NPN Transistor	SOT23	BC857B	INFINEON
23	Q3	800V 2A	MOSFET	DPAK	SPD02N80C3	INFINEON
24	R1	100R 2W	Metal Film Resistor, 5%	4 x 10	MFP2-100R JI	WELWYN
25	R4	1.2kOhm 2W	Metal Film Resistor, 5%	4 x 10	MFP2-1K2 JI	WELWYN
26	R5	1MOhm 1W	Metal Film Resistor, 5%	2.5 x 6.2	MFP1-1M JI	WELWYN
27	R6	100R 1W	Metal Film Resistor, 5%	2.5 x 6.2	MFP1-100R JI	WELWYN
28	R7	4.7kOhm	Metal Film Resistor, 1%	0805		
29	R8	1.1MOhm	Metal Film Resistor, 1%	1206		
30	R9	1MOhm	Metal Film Resistor, 1%	1206		
31	R10	5.1kOhm	Metal Film Resistor, 1%	0805		
32	R11	82kOhm	Metal Film Resistor, 1%	0603		
33	R12	25.5kOhm	Metal Film Resistor, 1%	0603		
34	R13	160kOhm	Metal Film Resistor, 1%	0603		
35	R14, R15, R19	10R	Metal Film Resistor, 1%	0805		
36	R16	20kOhm	Metal Film Resistor, 1%	0603		
37	R17	3.3kOhm	Metal Film Resistor, 1%	0603		
38	R20	2R	Metal Film Resistor, 1%	0805		
39	R21	56kOhm	Metal Film Resistor, 1%	0805		
40	R23	0R	Metal Film Resistor, 1%	0805		
41	T1		Transformer, Lp = 3.9mH, Np:Ns:Naux = 139:24:12	EF20	750845151	Würth Elektronik
42	VR1	470V	Varistor, 19J, 300Vrms	5mm Disc	MCFT000231	Multicomp
43	ZD1	15V	Zener Diode, 2%	SOD323	PDZ15B,115	NXP
44	ZD2	4.7V	Zener Diode, 2%	SOD323	PDZ4.7B,115	NXP

Figure 18 Bill Of Material

8.2 Transformer

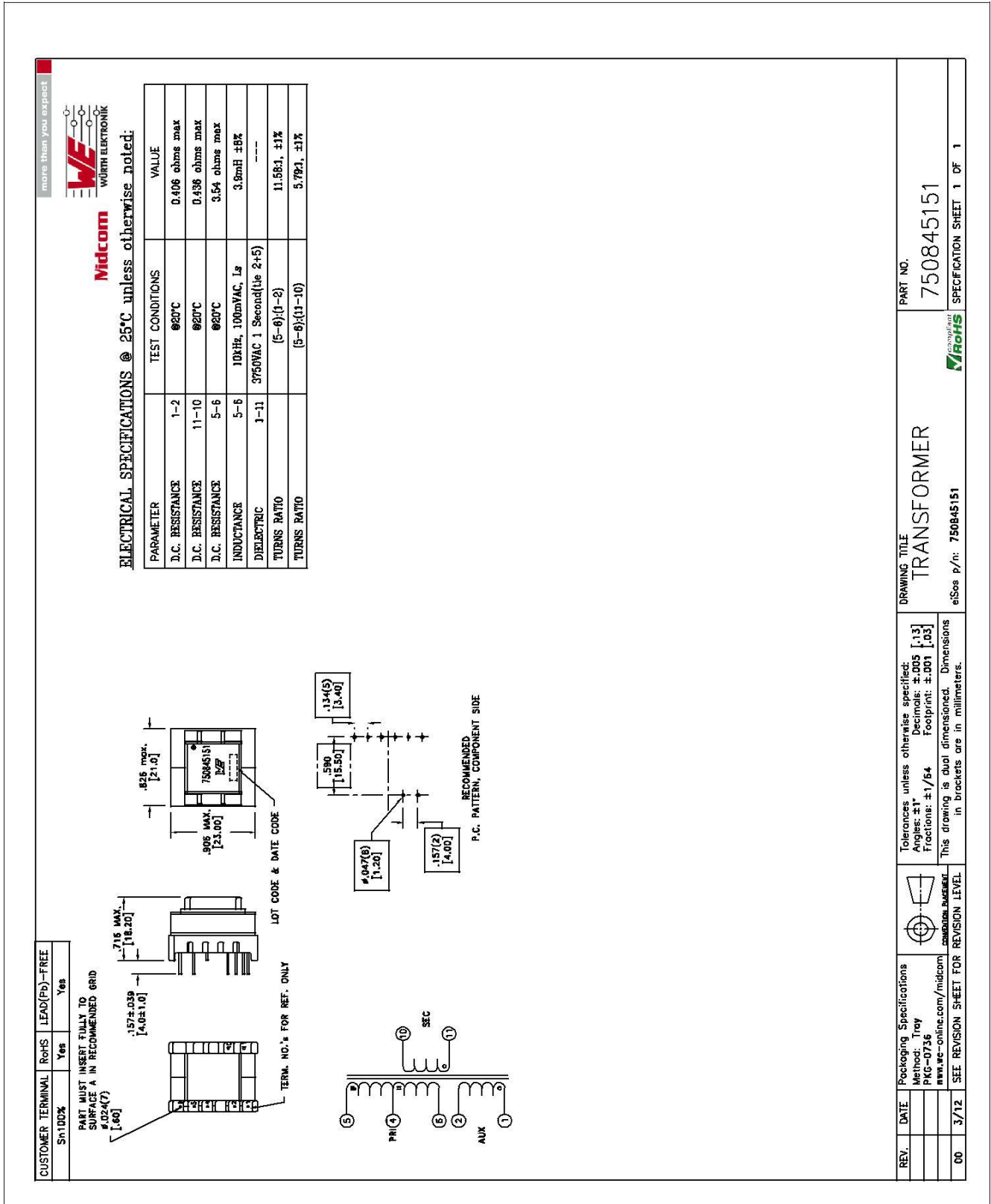

Figure 19 EVALLED-ICL8002G-B1 Transformer Design

9 Design Customization

To facilitate design customization for different output voltage and/or output current than given in this demo board, Infineon offers an interactive online design solution, the [Infineon Light Desk](#).

With this cloud-based design tool, users are able to specify the system requirements, create the schematic and BOM, run simulation, and generate a design summary report. Users are advised to verify and tune the design for key performances such as efficiency, PF, EMI, and dimming compatibility with prototyping before finalizing their product design. [Figure 20](#) and [Figure 21](#) show some snap shots of the [Infineon Light Desk](#).

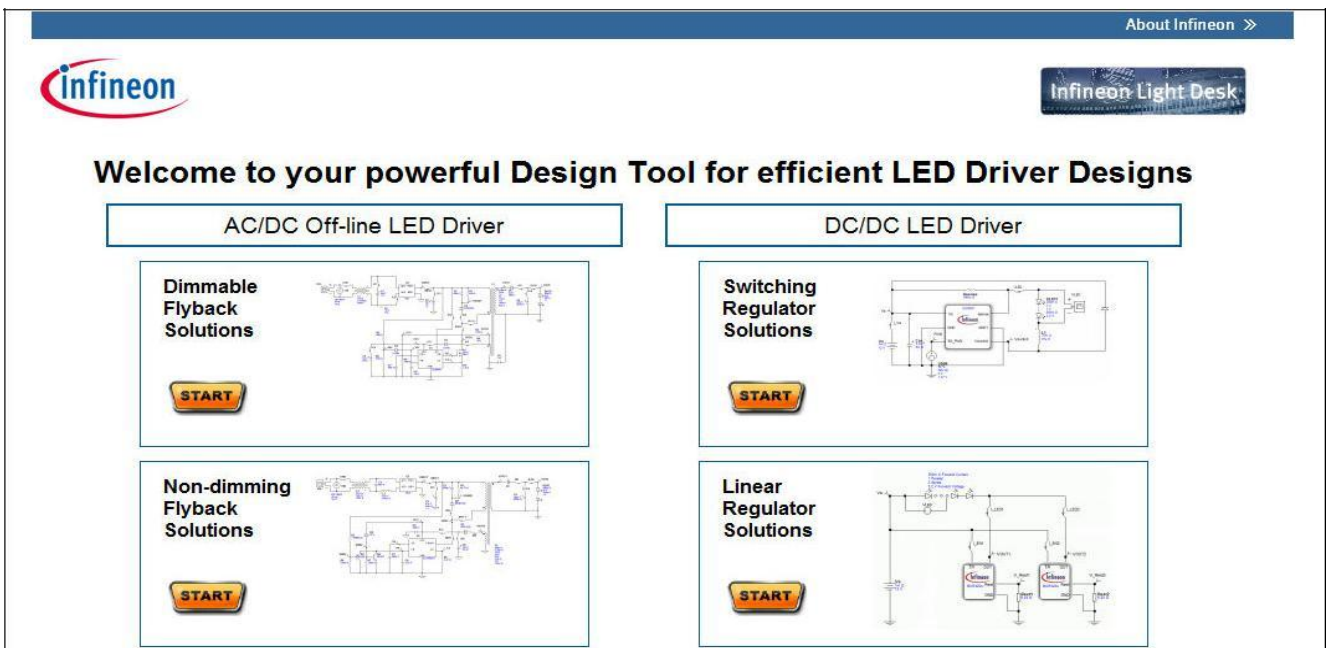

Figure 20 Infineon Light Desk - Selection of solutions

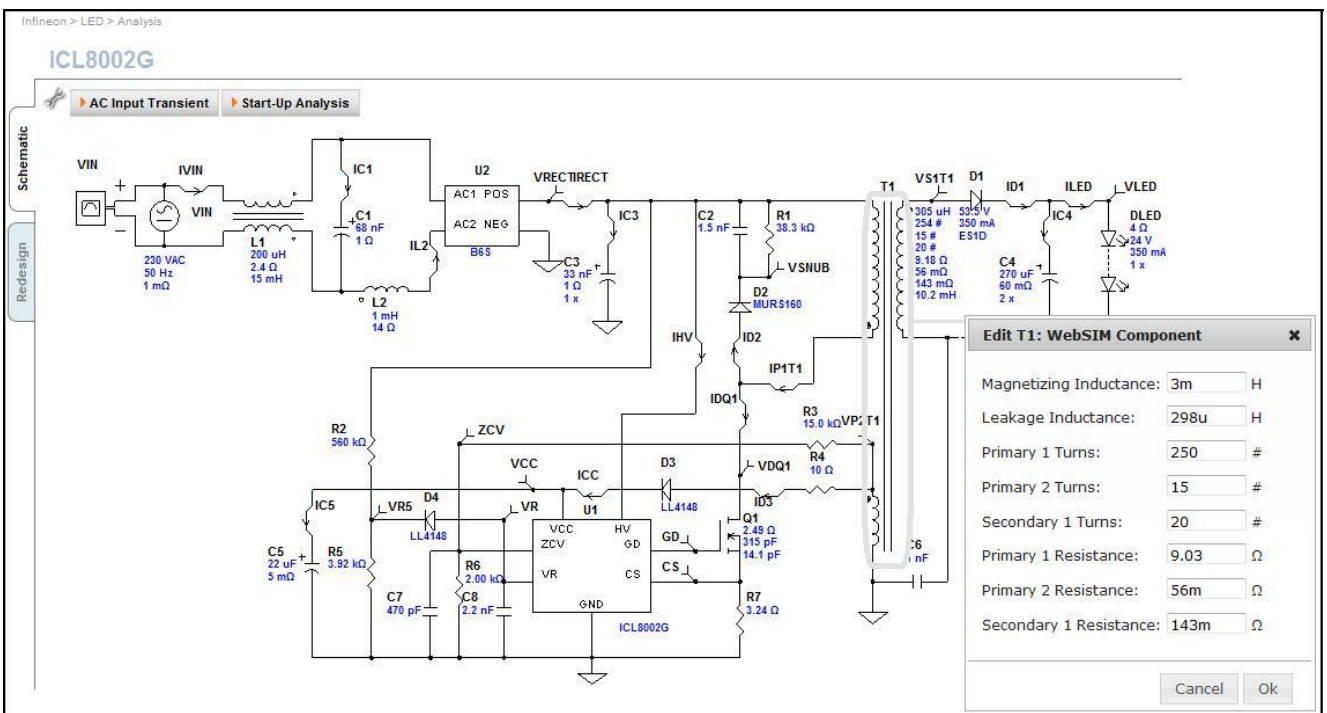

Figure 21 Infineon Light Desk - Interactive web schematic

10 Common Questions and Troubleshooting Hints

10.1 Q&A

How does ICL8002G realize dimming control and power factor correction?

Both dimming control and PFC are achieved with the input mains voltage sensing with the VR pin. This signal is used to set the peak current of the primary winding and consequently allows for both PFC and phase-cut dimming functionality by regulating the cycle energy.

How does the ICL8002G regulate the output LED current?

ICL8002G does not regulate the output current directly. Instead it produces a constant output power. The LED load will operate at the point (current and voltage) where its I-V characteristic curve crosses the constant power curve.

Is it possible to test the demo board with different LED modules with big variations in total forward voltages?

The operation range of output voltage is specified in [Table 1](#). The demo board will switch into protection mode when tested with LED load with out-of-range forward voltage either due to Vcc overvoltage protection or Vcc undervoltage protection. Modification on the transformer design is necessary for applications with different output voltage.

What will happen under no-load conditions?

Under no-load conditions this demo board will go into auto restart mode with output voltage reaches higher than 45V. It is therefore advised to connect proper LED loads before switching on the power.

10.2 Troubleshooting hints

Why is there no light output after the LED load is connected and power is on?

Please verify the following:

- Connectivity of AC input and LED load
- LED module's polarity
- Whether LED module's forward voltage is out of the range specified in [Table 1](#)
- Conductivity of fuse

How to change output current?

With fixed LED load, the output current is proportional to output power, which is a function of primary current. Therefore by adjusting the VR pin's voltage and shunt resistor the desired output current can be set. However, great care must be taken to ensure that the transformer is not driven into saturation with high primary current. Moreover, the VR pin's voltage should be kept below 3.7V for maximum power factor.

How to change the open circuit protection mode to Latched Off Mode?

If Latched Off Mode is preferred for output open circuit protection, R16 and/or R17 can be adjusted so that OVP threshold ($V_{zcovp} = 3.7\text{ V}$) is reached first before the Vcc overvoltage threshold ($V_{vccovp} = 25\text{ V}$) is reached. Please note that with changing R16, the voltage foldback correction will be affected and as a result the line regulation will be affected. In this case R13 can be tuned for better line regulation.

Why is the LED flickering in my dimming application? How to improve?

Flickering can be either caused by IC auto-restart or by dimmer's uneven conduction phase angle. For the auto-restart case, the ICL8002G's Vcc voltage should be maintained between V_{vccovp} and V_{vccoff} over the whole dimming range. This can be achieved by proper transformer turn ratio design and, if necessary, a voltage regulation circuit for the Vcc. For dimmer's uneven conduction case, it is advised to tune the damping and bleeder circuits.

How to further improve efficiency?

Efficiency can be improved by reducing the value of damping resistors R1 and R6, and bleeder capacitor C1. However the dimming performance may be affected. Switching frequency can be reduced so as to minimize the switching loss and this may require bigger transformer size. Low ESR capacitor can be used for the output capacitor to improve efficiency. Using a higher current rated MOSFET for Q3, however, may not necessarily produce higher efficiency as the switching loss may dominate the total power loss of the MOSFET.

How to improve power factor and THD?

Reducing capacitance value of C1 and C4 can help to increase power factor and to reduce THD. Do note that both dimming and EMI performance can be affected. Increasing reflection voltage of the transformer can also help to improve power factor. Care must be taken to ensure the MOSFET Q3's breakdown voltage is not exceeded under worst case operation.

How to reduce BOM cost?

For low cost application, the active damper circuit formed by R5, R6, C2, and thyristor Q1 can be removed. A 600V rated MOSFET can be used for Q3 and this requires the transformer to be designed with lower reflection voltage and as a result power factor may be reduced.

11 References

[ICL8002G Datasheet](http://www.infineon.com/ledoffline) at www.infineon.com/ledoffline

[Design Guidelines for ICL8001G/ICLS8082G](http://www.infineon.com/ledoffline) at www.infineon.com/ledoffline

[Infineon Light Desk](http://www.infineon.com/lightdesk) at www.infineon.com/lightdesk

www.infineon.com

Published by Infineon Technologies AG