



Chipsmall Limited consists of a professional team with an average of over 10 year of expertise in the distribution of electronic components. Based in Hongkong, we have already established firm and mutual-benefit business relationships with customers from,Europe,America and south Asia,supplying obsolete and hard-to-find components to meet their specific needs.

With the principle of “Quality Parts,Customers Priority,Honest Operation,and Considerate Service”,our business mainly focus on the distribution of electronic components. Line cards we deal with include Microchip,ALPS,ROHM,Xilinx,Pulse,ON,Everlight and Freescale. Main products comprise IC,Modules,Potentiometer,IC Socket,Relay,Connector.Our parts cover such applications as commercial,industrial, and automotives areas.

We are looking forward to setting up business relationship with you and hope to provide you with the best service and solution. Let us make a better world for our industry!



## Contact us

Tel: +86-755-8981 8866 Fax: +86-755-8427 6832

Email & Skype: info@chipsmall.com Web: www.chipsmall.com

Address: A1208, Overseas Decoration Building, #122 Zhenhua RD., Futian, Shenzhen, China



DATA SHEET

# AWB7239: 1.880 to 1.930 GHz Small-Cell Power Amplifier Module

## Applications

- LTE, WCDMA and HSDPA air interfaces
- FDD and TDD systems
- Picocell, femtocell, home nodes
- Customer premises equipment
- Data cards and terminals

## Features

- InGaP HBT technology
- -47 dBc ACPR @ ±10 MHz, +27 dBm
- 31 dB gain
- High efficiency
- Low transistor junction temperature
- Matched for a 50 Ω system
- Low profile miniature surface-mount package; RoHS compliant
- Multi-carrier capability
- Surface-mount (14-pin, 7 × 7 × 1.3 mm) package (MSL4, 260 °C per JEDEC J-STD-020)



Skyworks Green™ products are compliant with all applicable legislation and are halogen-free. For additional information, refer to *Skyworks Definition of Green™*, document number SQ04-0074.



## Description

The AWB7239 is a fully matched, Multi-Chip-Module (MCM) designed for picocell, femtocell, and customer premises equipment (CPE) applications. Its high linearity and efficiency meet the extremely demanding needs of small-cell infrastructure architectures. Designed for LTE, WCDMA, and HSDPA air interfaces operating in the 1.880 to 1.930 GHz band, the AWB7239 delivers up to +27 dBm of LTE (E-TM1.1) power with an ACPR of -47 dBc. The device operates from a convenient +4.5 V supply and provides 30 dB of gain.

The device is manufactured using an advanced InGaP HBT MMIC technology offering state-of-the-art reliability, temperature stability, and ruggedness. The self-contained 7 x 7 x 1.3 mm surface-mount package incorporates RF matching networks optimized for output power, efficiency, and linearity in a 50 Ω system.

A block diagram of the AWB7239 is shown in Figure 1. The device package and pinout are shown in Figure 2. Signal pin assignments and functional pin descriptions are described in Table 1.

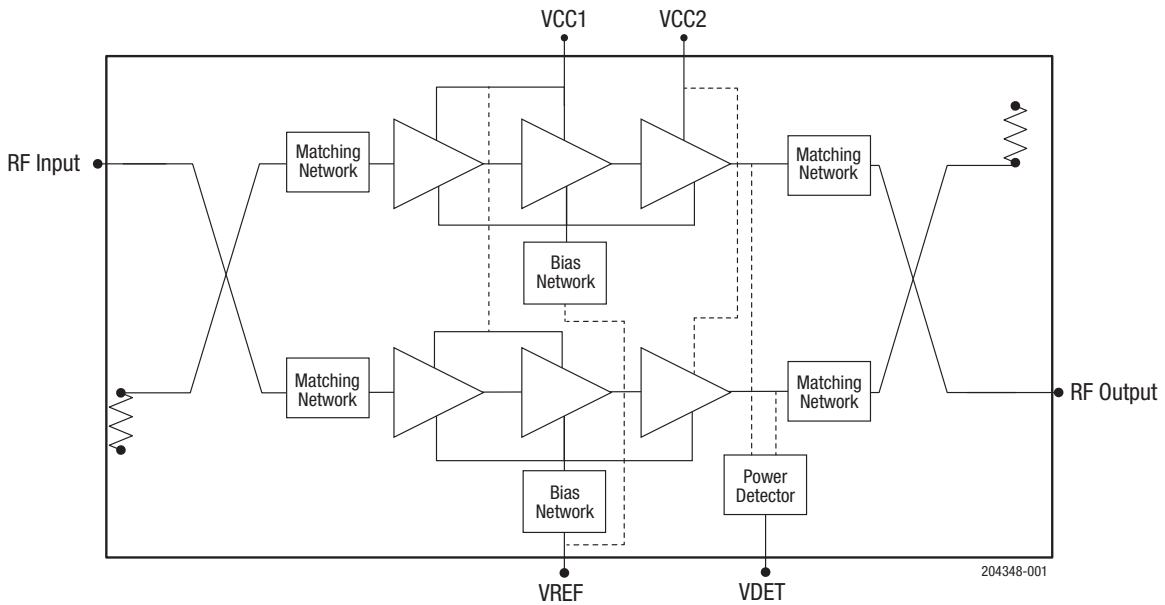

Figure 1. AWB7239 Block Diagram

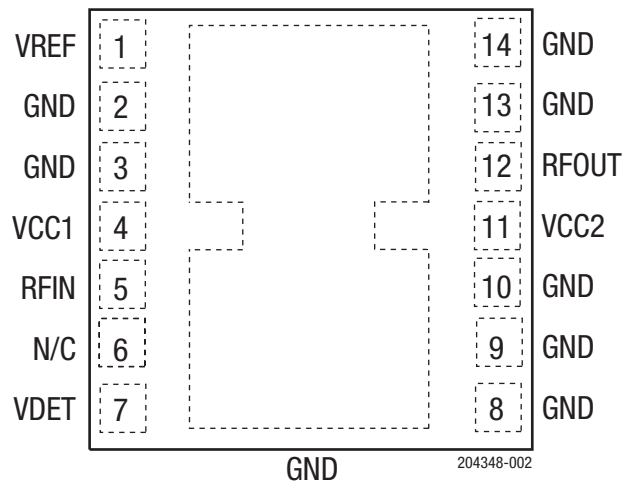

Figure 2. AWB7239 Pinout (Top View)

Table 1. AWB7124 Signal Pin Descriptions

Pin	Name	Description	Pin	Name	Description
1	VREF	Reference voltage	8	GND	Ground
2	GND	Ground	9	GND	Ground
3	GND	Ground	10	GND	Ground
4	VCC1	Supply voltage	11	VCC2	Supply voltage
5	RFIN	RF input	12	RFOUT	RF output
6	N/C	No connection	13	GND	Ground
7	VDET	Detector output	14	GND	Ground

## Electrical and Mechanical Specifications

The absolute maximum ratings of the AWB7239 are provided in Table 2. Recommended operating conditions are specified in Table 3, and electrical specifications are provided in Table 4.

**Table 2. AWB7239 Absolute Maximum Ratings<sup>1</sup>**

Parameter	Minimum	Maximum	Units
Supply voltage (VCC)		+5	V
Reference voltage (VREF)		+3.5	V
RF output power (POUT)		+30	dBm, modulated
RF input power (PIN)		+10	dBm, CW
Electrostatic discharge:			
Human Body Model, Class 1C <sup>2</sup>		2000	V
Charged Device Model, Class 3 <sup>3</sup>		<1000	V
Junction temperature (TJ)	-	+150	°C
Storage temperature (TSTG)	-40	+150	°C

<sup>1</sup> Exposure to maximum rating conditions for extended periods may reduce device reliability. There is no damage to device with only one parameter set at the limit and all other parameters set at or below their nominal value. Exceeding any of the limits listed here may result in permanent damage to the device.

<sup>2</sup> JEDEC JS-001-2010.

<sup>3</sup> JEDEC JESD22-C101D.

**ESD HANDLING:** *Although this device is designed to be as robust as possible, electrostatic discharge (ESD) can damage this device. This device must be protected at all times from ESD when handling or transporting. Static charges may easily produce potentials of several kilovolts on the human body or equipment, which can discharge without detection. Industry-standard ESD handling precautions should be used at all times.*

**Table 3. AWB7239 Recommended Operating Conditions<sup>1</sup>**

Parameter	Symbol	Min	Typ	Max	Units
Operating frequency	f	1880		1930	MHz
Supply voltage	VCC	+3.6	+4.5	+4.65	V
Reference voltage:					
PA on	VREF	+2.8	+2.85	+2.9	V
PA off		0		+0.5	V
RF output power <sup>2</sup>	POUT		+27		dBm
Case temperature <sup>3</sup>	Tc	-40		+85	°C

<sup>1</sup> The device may be operated safely over these conditions; however, parametric performance is guaranteed only over the conditions defined in the electrical specifications.

<sup>2</sup> Typ RF output power is used during production test.

<sup>3</sup> Case temperature references the board temperature at the ground paddle on the backside of the package.

**Table 4. AWB7239 Electrical Specifications<sup>1</sup>**  
 (T<sub>C</sub> = +25 °C, V<sub>CC</sub> = +4.5 V, V<sub>REF</sub> = +2.85 V, 50 Ω system)

Parameter	Symbol	Test Condition	Min	Typ	Max	Units
Gain <sup>2</sup>	G	1880 to 1930 MHz	27	31	35	dB
ACPR: <sup>1,2,3</sup> @ 10 MHz offset @ 20 MHz offset		10 MHz channel BW		-47 -57	-45 -55	dBc dBc
Power-added efficiency <sup>1,2,3</sup>			12	15		%
Thermal resistance <sup>4</sup>	R <sub>JC</sub>	Junction to case		10.7		°C/W
Supply current <sup>1,2,3</sup>	V <sub>CC</sub>	Total through VCC pins		750	925	mA
Quiescent current	I <sub>cq</sub>		140	225	310	mA
Reference current		Through VREF pin	10	14	18	mA
Leakage current		V <sub>CC</sub> = +5 V, V <sub>REF</sub> = 0 V		3	10	μA
Harmonics: 2fo, 4fo 3fo				-55 -50	-50 -45	dBc dBc
Input return loss			15	20		dB
Output return loss			15	20		dB
RF switching time: <sup>5</sup> Rise time (PA off to on) Fall time (PA on to off)		V <sub>CC</sub> = +4.5 V, V <sub>REF</sub> switched between 0 V and +2.85 V			12 4	μs μs
Spurious output level (all spurious outputs)		P <sub>OUT</sub> ≤ +27 dBm, in-band load VSWR < 5:1, Out-of-band load VSWR < 10:1, applies over all voltage and temperature operating ranges			-60	dBc
Load mismatch stress with no permanent degradation or failure		V <sub>CC</sub> = +4.5 V, P <sub>OUT</sub> = +27 dBm Applies over full operating temperature range	8:1			VSWR

<sup>1</sup> ACPR and Efficiency measured at 1905 MHz.

<sup>2</sup> P<sub>OUT</sub> = +27 dBm.

<sup>3</sup> LTE E-TM1.1 (10 MHz).

<sup>4</sup> Use only V<sub>CC2</sub> (pin 11) current when calculating device junction temperature.

<sup>5</sup> Rise Time defined from time at which V<sub>REF</sub> is switched from 0 V to +2.85 V, to time at which the RF output power achieves 90% of the average steady-state "on" level; Fall Time defined from time at which V<sub>REF</sub> is switched from +2.85 V to 0 V, to time at which the RF output power decreases to 10% of the average steady-state "on" level.

### Evaluation Board Description

The AWB7239 Evaluation Board is used to test the performance of the AWB7239 device. A schematic of a typical application circuit is shown in Figure 3.

### Shutdown Mode

The power amplifier can be placed in shutdown mode by applying logic low levels (see Table 3) to the V<sub>REF</sub> voltage.

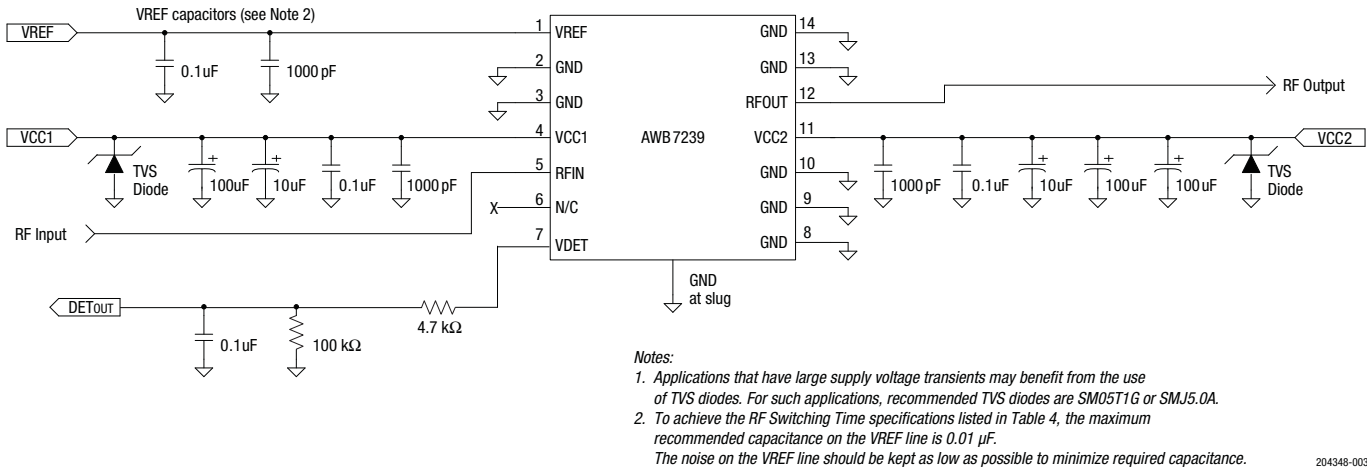

Figure 3. AWB7239 Evaluation Board Schematic

### Package Dimensions

The PCB layout footprint drawing for the AWB7239 is shown in Figure 4. Typical part markings are shown in Figure 5. The package dimensions for the AWB7239 are shown in Figure 6. The tape and reel dimensions are provided in Figure 7.

### Package and Handling Information

Since the device package is sensitive to moisture absorption, it is baked and vacuum packed before shipping. Instructions on the shipping container label regarding exposure to moisture after the container seal is broken must be followed. Otherwise, problems related to moisture absorption may occur when the part is subjected to high temperature during solder assembly.

The AWB7239 is rated to Moisture Sensitivity Level 4 (MSL4) at 260 °C. It can be used for lead or lead-free soldering. For additional information, refer to the Skyworks Application Note, *Solder Reflow Information*, document number 200164.

Care must be taken when attaching this product, whether it is done manually or in a production solder reflow environment. Production quantities of this product are shipped in a standard tape and reel format.

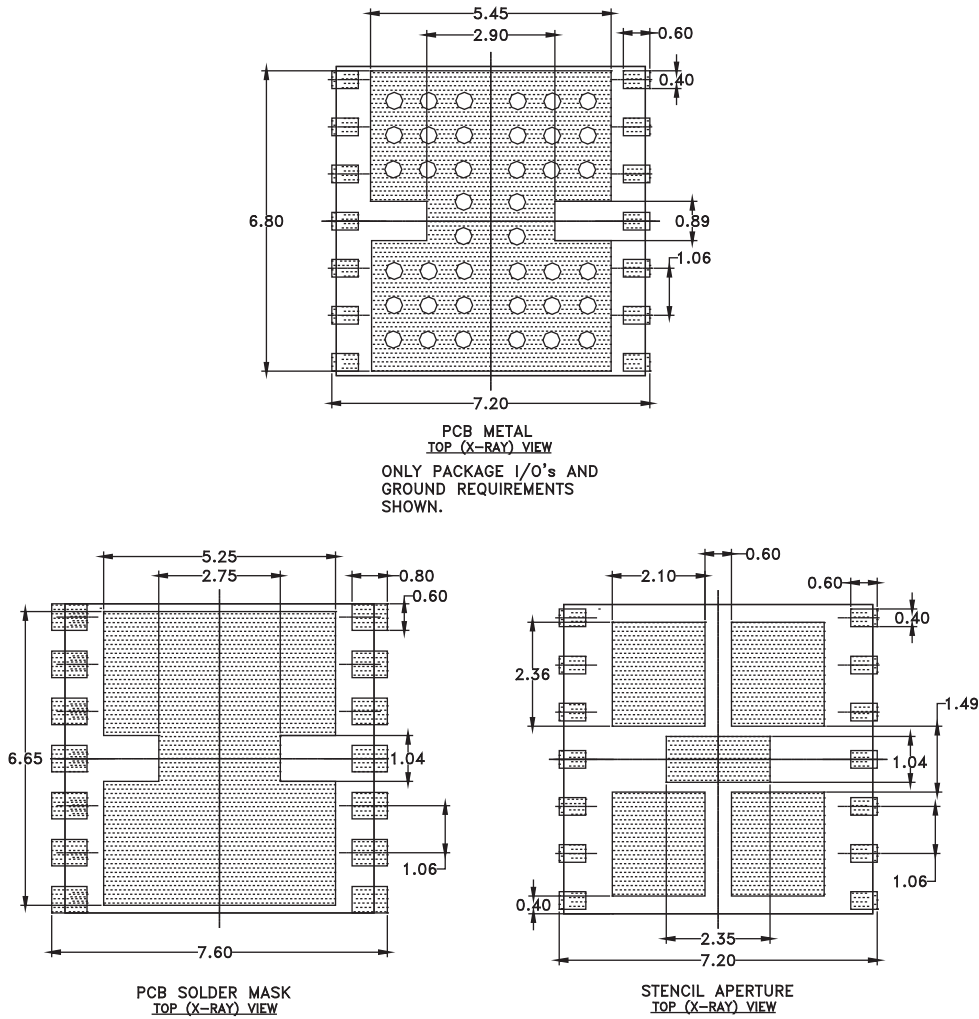

Notes:

1. Unless specified, dimensions are symmetrical about center lines shown.
2. Dimensions are in millimeters.
3. Vias shown in PCB Metal View are for reference only. Number and size of thermal vias required are dependent on heat dissipation requirements and the PCB process capability.

204348-004

**Figure 4. AWB7239 PCB Layout Footprint Dimensions**

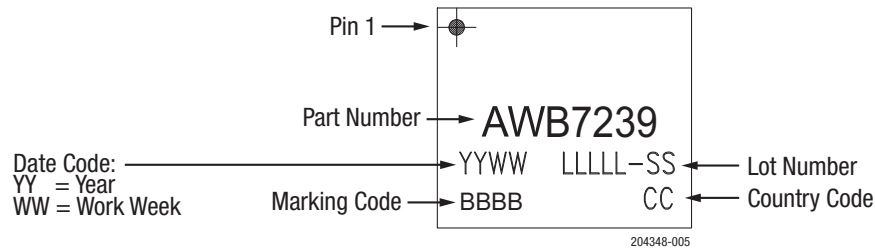

**Figure 5. AWB7239 Typical Part Marking**

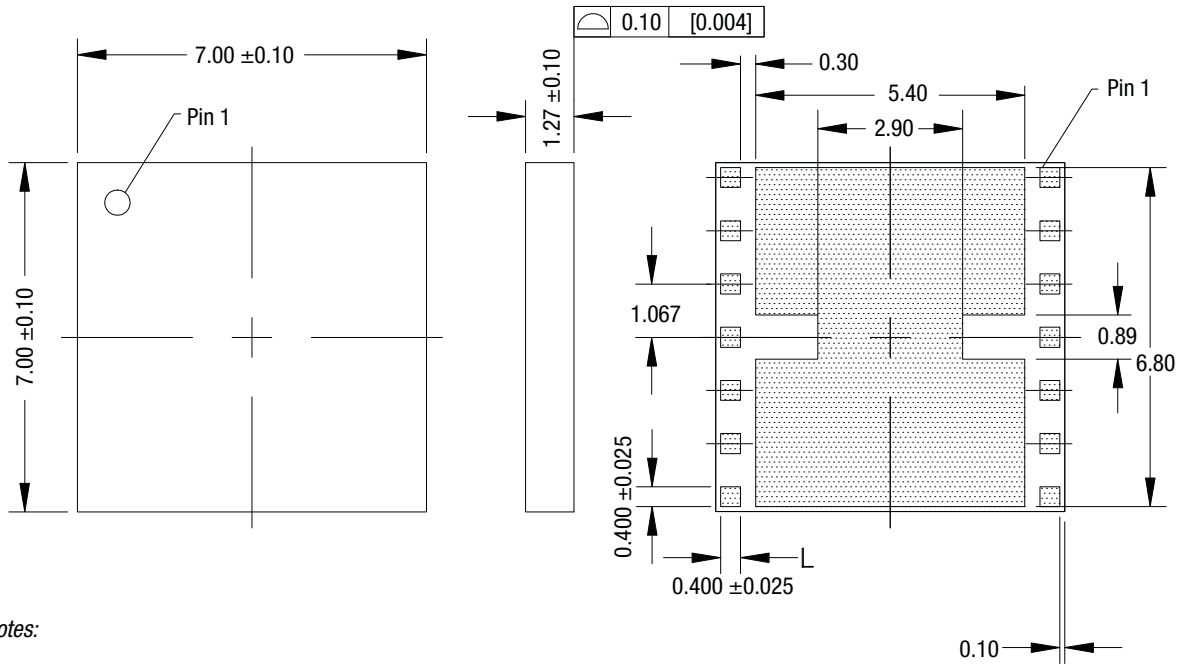

**Notes:**

1. All dimensions are in millimeters.
2. Unless specified otherwise, tolerance =  $\pm 0.076$  [0.003].
3. Pads (including center) are shown as uniform size for reference only.  
Actual pad size and location will vary within the minimum and maximum dimensions according to the specific laminate design.

204348-006

**Figure 6. AWB7239 Package Dimensions**

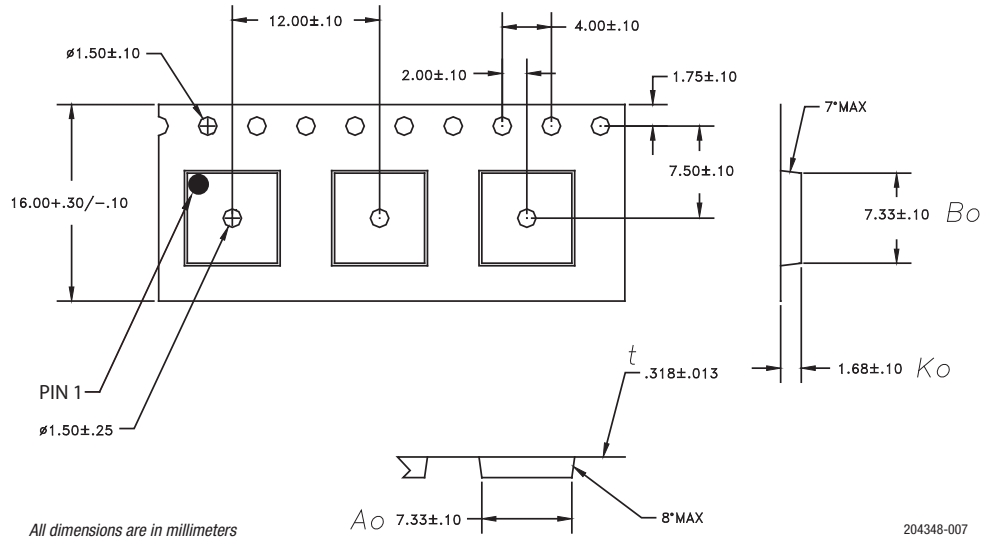

All dimensions are in millimeters

204348-007

**Figure 7. AWB7239 Tape and Reel Dimensions**



## Ordering Information

Model Number	Package Description	Component Packaging
AWB7239P8	RoHS-compliant 14-pin 7 x 7 x 1.3 mm surface-mount module	2500-piece tape and reel
EVB7239		Evaluation Board part number

Copyright © 2017 Skyworks Solutions, Inc. All Rights Reserved.

Information in this document is provided in connection with Skyworks Solutions, Inc. (“Skyworks”) products or services. These materials, including the information contained herein, are provided by Skyworks as a service to its customers and may be used for informational purposes only by the customer. Skyworks assumes no responsibility for errors or omissions in these materials or the information contained herein. Skyworks may change its documentation, products, services, specifications or product descriptions at any time, without notice. Skyworks makes no commitment to update the materials or information and shall have no responsibility whatsoever for conflicts, incompatibilities, or other difficulties arising from any future changes.

No license, whether express, implied, by estoppel or otherwise, is granted to any intellectual property rights by this document. Skyworks assumes no liability for any materials, products or information provided hereunder, including the sale, distribution, reproduction or use of Skyworks products, information or materials, except as may be provided in Skyworks Terms and Conditions of Sale.

THE MATERIALS, PRODUCTS AND INFORMATION ARE PROVIDED “AS IS” WITHOUT WARRANTY OF ANY KIND, WHETHER EXPRESS, IMPLIED, STATUTORY, OR OTHERWISE, INCLUDING FITNESS FOR A PARTICULAR PURPOSE OR USE, MERCHANTABILITY, PERFORMANCE, QUALITY OR NON-INFRINGEMENT OF ANY INTELLECTUAL PROPERTY RIGHT; ALL SUCH WARRANTIES ARE HEREBY EXPRESSLY DISCLAIMED. SKYWORKS DOES NOT WARRANT THE ACCURACY OR COMPLETENESS OF THE INFORMATION, TEXT, GRAPHICS OR OTHER ITEMS CONTAINED WITHIN THESE MATERIALS. SKYWORKS SHALL NOT BE LIABLE FOR ANY DAMAGES, INCLUDING BUT NOT LIMITED TO ANY SPECIAL, INDIRECT, INCIDENTAL, STATUTORY, OR CONSEQUENTIAL DAMAGES, INCLUDING WITHOUT LIMITATION, LOST REVENUES OR LOST PROFITS THAT MAY RESULT FROM THE USE OF THE MATERIALS OR INFORMATION, WHETHER OR NOT THE RECIPIENT OF MATERIALS HAS BEEN ADVISED OF THE POSSIBILITY OF SUCH DAMAGE.

Skyworks products are not intended for use in medical, lifesaving or life-sustaining applications, or other equipment in which the failure of the Skyworks products could lead to personal injury, death, physical or environmental damage. Skyworks customers using or selling Skyworks products for use in such applications do so at their own risk and agree to fully indemnify Skyworks for any damages resulting from such improper use or sale.

Customers are responsible for their products and applications using Skyworks products, which may deviate from published specifications as a result of design defects, errors, or operation of products outside of published parameters or design specifications. Customers should include design and operating safeguards to minimize these and other risks. Skyworks assumes no liability for applications assistance, customer product design, or damage to any equipment resulting from the use of Skyworks products outside of stated published specifications or parameters.

Skyworks and the Skyworks symbol are trademarks or registered trademarks of Skyworks Solutions, Inc., in the United States and other countries. Third-party brands and names are for identification purposes only, and are the property of their respective owners. Additional information, including relevant terms and conditions, posted at [www.skyworksinc.com](http://www.skyworksinc.com), are incorporated by reference.